

AMERICAN F^YRE DESIGNS™

outdoor products collection

AFD PRODUCTS ARE FOR OUTDOOR USE ONLY



TABLE OF CONTENTS

DESCRIPTION	PAGE
Fireplaces	2-3
Fireplace Accessories	4-5
Chat Height Firetables	6-7
Dining Height Firetables	8
Fire Bowls	9
Fire Pits & Lanterns	10
Fire Urns	11
Fyre Glass, Fyre Gems, & Diamond Nuggets	12
Fyre Spheres, Outdoor Gas Logs, Stones, & Lava Media	13
Protective Covers & Tank/End Tables	14
Glass Wind Guards, Conversion Kits, & Repl. Burners	15
Ordering Guide & Warranty Information	16

STEP 1: (Choose a Vented or Vent Free Fireplace)

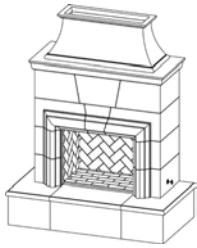

Cordova	
Vented #:	022-XX-X-XX-XXC
Vent-Free #:	122-XX-X-XX-XXC
Dimensions:	76" w x 41" d x 95" h
Wt. (lbs) / Pcs.:	1700 / 11
Vented:	\$10,121
Vent-Free:	\$10,645

Reduced Cordova	
Vented #:	023-XX-X-XX-XXC
Vent-Free #:	123-XX-X-XX-XXC
Dimensions:	76" w x 41" d x 82" h
Wt. (lbs) / Pcs.:	1600 / 10
Vented:	\$10,121
Vent-Free:	\$10,645

STEP 2: (Choose Hearth Style)

Compatible Hearths for Cordova & Reduced Cordova

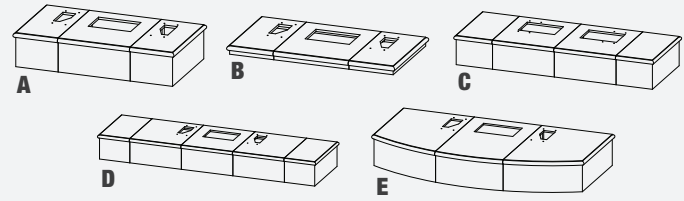

HEARTH DESCRIPTION	DIMENSIONS	MODEL #	PRICE
A 16" Rectangle Bullnose	76" w x 41" d x 16" h	XXX-20-X-XX-XXC	N/C
B 4" Rectangle Bullnose	76" w x 41" d x 4" h	XXX-22-N-XX-XXC	N/C
C 110" Rect. Extended Bullnose	110" w x 41" d x 16" h	XXX-35-X-XX-XXC	\$840
D 144" Rect. Extended Bullnose	144" w x 41" d x 16" h	XXX-36-X-XX-XXC	1,844
E 110" Radiused Bullnose	110" w x 56 1/2" d x 16" h	XXX-37-X-XX-XXC	928

All Fireplaces shown and weighed with 16" standard hearth. Extended hearths add two additional pieces to the total count.

STEP 1

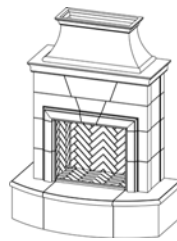

Phoenix	
Vented #:	017-XX-X-XX-XXC
Vent-Free #:	117-XX-X-XX-XXC
Dimensions:	65" w x 36" d x 87" h
Wt. (lbs) / Pcs.:	1100 / 7
Vented:	\$6,590
Vent-Free:	\$7,139

Mariposa	
Vented #:	073-XX-X-XX-XXC
Vent-Free #:	173-XX-X-XX-XXC
Dimensions:	65" w x 36" d x 67" h
Wt. (lbs) / Pcs.:	970 / 7
Vented:	\$6,590
Vent-Free:	\$7,139

Petite Cordova	
Vented #:	025-XX-X-XX-XXC
Vent-Free #:	125-XX-X-XX-XXC
Dimensions:	65" w x 36" d x 84" h
Wt. (lbs) / Pcs.:	1100 / 10
Vented:	\$6,590
Vent-Free:	\$7,139

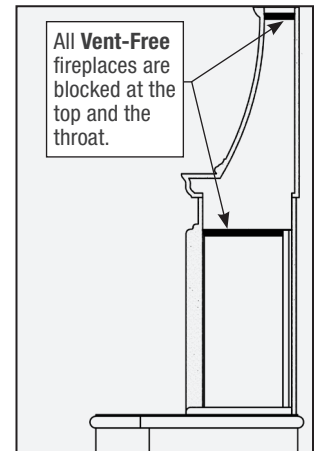

All Vent-Free fireplaces are blocked at the top and the throat.

Vent-Free Fireplaces are **certified** to go under a covered area.

STEP 2

Compatible Hearth for Phoenix, Mariposa & Petite Cordova

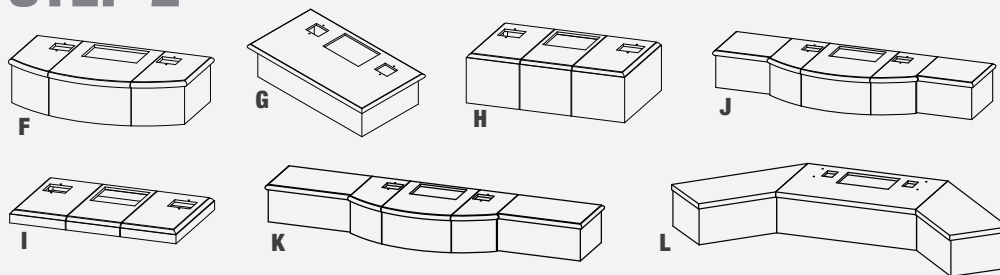

HEARTH DESCRIPTION	DIMENSION	MODEL #	PRICE
F 16" Radiused Bullnose	65" w x 36" d x 16" h	XXX-01-X-XX-XXC	N/C
G 16" Rectangle Bullnose	65" w x 36" d x 16" h	XXX-02-X-XX-XXC	N/C
H 16" Roundover	52" w x 32" d x 16" h	XXX-03-X-XX-XXC	N/C
I 4" Roundover	52" w x 32" d x 4" h	XXX-04-N-XX-XXC	N/C
J 113" Extended Bullnose	113" w x 36" d x 16" h	XXX-05-X-XX-XXC	\$721
K 137" Extended Bullnose	137" w x 36" d x 16" h	XXX-06-X-XX-XXC	972
L Corner Square Edge	Refer to drawing	XXX-08-X-XX-XXC	1,200

All Fireplaces shown and weighed with 16" standard hearth. Extended hearths add two additional pieces to the total count.

FIREBOX LINERS

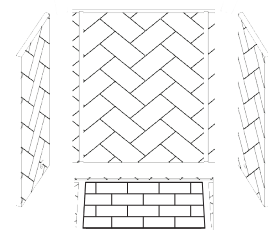

All fireplaces include 4 herringbone firebox liners (included in the total piece count)

STEP 3: (Choose Recess Option)

2" RECESS OPTIONS for above Fireplaces & Hearths

No Recess	XXX-XX-N-XX-XXC	N/C
Hearth Only	XXX-XX-H-XX-XXC	\$512
Hearth & Body	XXX-XX-A-XX-XXC	512

Fireplaces may be ordered with **recessed** hearth and/or body to accommodate field cladding in tile, stone or other veneer.

STEP 1 & 2

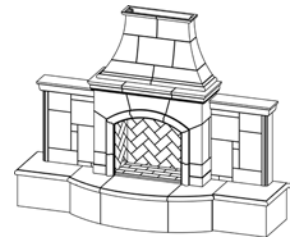
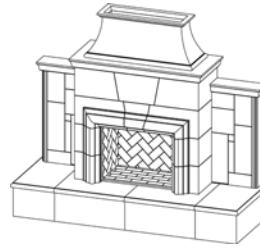
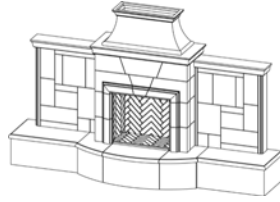
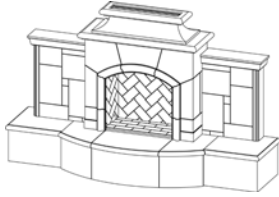

Grand Mariposa (w/ Extended Bullnose Hearth)	
Vented #:	868-05-X-XX-XXC
Vent-Free #:	168-05-X-XX-XXC
Dimensions:	113"w x 36"d x 67"h
Wt. (lbs) / Pcs.:	1300 / 15
Vented:	\$10,121
Vent-Free:	\$10,710

Grand Petite Cordova (w/ Extended Bullnose Hearth)	
Vented #:	865-10-X-XX-XXC
Vent-Free #:	165-10-X-XX-XXC
Dimensions:	127"w x 36"d x 84"h
Wt. (lbs) / Pcs.:	1400 / 12
Vented:	\$11,233
Vent-Free:	\$11,798

Grand Cordova (w/ Rectangle Extended Bullnose Hearth)	
Vented #:	882-35-X-XX-XXC
Vent-Free #:	182-35-X-XX-XXC
Dimensions:	110"w x 41"d x 95"h
Wt. (lbs) / Pcs.:	1900 / 13
Vented:	\$13,297
Vent-Free:	\$13,887

Grand Phoenix (w/ Extended Bullnose Hearth)	
Vented #:	818-05-X-XX-XXC
Vent-Free #:	118-05-X-XX-XXC
Dimensions:	113"w x 36"d x 87"h
Wt. (lbs) / Pcs.:	1400 / 15
Vented:	\$10,121
Vent-Free:	\$10,710

STEP 3

RECESS OPTIONS for above Fireplaces & Hearths

No Recess	xxx-xx- N -xx-xxC	N/C
Hearth Only	xxx-xx- H -xx-xxC	\$512

Grand Fireplaces may be ordered with **recessed** hearth to accommodate field cladding in tile, stone or other veneer.

STEP 1, 2, & 3

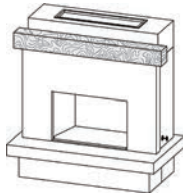
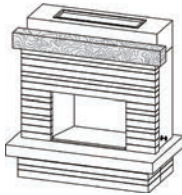

Brooklyn (w/ "Board-formed" Texture)	
Vented #:	050-CG-N-FO(SP)-XXC
Vent-Free #:	150-CG-N-FO(SP)-XXC
Dimensions:	68"w x 38"d x 68½"h
Wt. (lbs) / Pcs.:	1250 / 11
Vented:	\$8,411
Vent-Free:	\$8,803

Brooklyn Smooth (Accommodates field cladding)	
Vented #:	060-CG-N-FO(SP)-XXC
Vent-Free #:	160-CG-N-FO(SP)-XXC
Dimensions:	68"w x 38"d x 68½"h
Wt. (lbs) / Pcs.:	1250 / 11
Vented:	\$8,148
Vent-Free:	\$8,542

Contractor's Model	
Vented #:	040-11-A-WC-RBC
Vent-Free #:	140-11-A-WC-RBC
Dimensions:	67"w x 37"d x 96"h
Wt. (lbs) / Pcs.:	810 / 9
Vented:	\$4,374
Vent-Free:	\$4,952

Contractor's Model with Moulding	
Vented #:	045-11-A-WC-RBC
Vent-Free #:	145-11-A-WC-RBC
Dimensions:	67"w x 37"d x 91"h
Wt. (lbs) / Pcs.:	810 / 9
Vented:	\$4,952
Vent-Free:	\$5,529

Note: Brooklyn fireplaces feature a Concrete Grey (CG) body with a "Reclaimed Wood" style mantel. Must specify mantel finish when placing and order: **French Barrel Oak** (050-CG-N-FO-xxC) or **Silver Pine** (050-CG-N-SP-xxC).

Note: Contractor's Model Fireplaces come in **White (GFRC) finish only**, recessed to accommodate field cladding, and with the key/gas location on the right out the back only.

STEP 1, 2, & 3

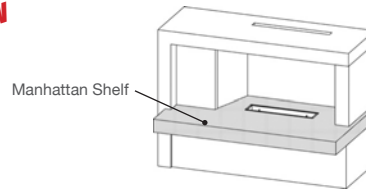

MANHATTAN ONLY

SHELF COLOR	MODEL #
White Aspen	xxx-WA-X-XX-XXXC
Café Blanco	xxx-CB-X-XX-XXXC
Black Lava	xxx-BA-X-XX-XXXC
Smoke	xxx-SM-X-XX-XXXC
Smooth Black	xxx-SB-X-XX-XXXC

To select the body color turn to page 4.

NEW

Milan Low Linear Fireplace*	
Model #:	211-LO-N-xx-M8xC
Dimensions:	72"w x 16"d x 44"h
Wt. (lbs) / Pcs.:	560 / 8
Price:	\$7,259

Milan Tall Linear Fireplace*	
Model #:	211-TA-N-xx-M8xC
Dimensions:	72"w x 16"d x 60"h
Wt. (lbs) / Pcs.:	730 / 9
Price:	\$8,855

Manhattan (w/ Mirror Stainless Steel Liner)	
Model #:	082-xx-N-xx-M3NC
Dimensions:	59"w x 32"d x 42"h
Wt. (lbs) / Pcs.:	750 / 8
Price:	\$7,836

The Manhattan comes with a Natural Gas burner. For Propane change the **next to last** digit from an "N" to a "P". Manhattan Propane version has access door to house a Propane tank.

NEW

w/ FyreStarter Ignition System †	
Model #:	211-LO-N-xx-H8xC
Price:	\$9,369

w/ FyreStarter Ignition System †	
Model #:	211-TA-N-xx-H8xC
Price:	\$10,965

FIREPLACE VALVES

VALVE	DESCRIPTION	GAS	BTU's
M3	Linear Burner	NG	40k
	Linear Burner	LP	40k
M8	48" Linear Burner	NG	65k
	48" Linear Burner	LP	65k
H8	48" Burner w/ FyreStarter	NG	100k
	48" Burner w/ FyreStarter	LP	100k

M-series valves now include a piezo igniter.

* Cannot accommodate an LP tank inside the unit; selecting Propane may require Tank/End Table and Hose (see page 14).

† FyreStarter = Bluetooth remote control, requires 120 Volt AC Power. Includes A and C USB ports.

STEP 4: (Choose Finish)

FINISH COLORS	MODEL #
White Aspen	XXX-XX-X-WA-XXC
Café Blanco	XXX-XX-X-CB-XXC
Black Lava	XXX-XX-X-BA-XXC
Smoke	XXX-XX-X-SM-XXC

ANTIQUÉ FINISHES	MODEL #
Travertine	XXX-XX-X-TR-XXC
Dark Basalt	XXX-XX-X-DB-XXC
Light Basalt	XXX-XX-X-LB-XXC

Milan Linear Fireplaces Only
(In addition to the standard Finish Colors)

- American Fyre Designs™ products are individually handcrafted, the finishes listed are subject to slight texture and color variation.
- American Fyre Designs™ reserves the right to change or discontinue finishes without prior notice. Samples available upon request.
- Brooklyn Fireplaces are only available in **Concrete Grey (CG)** finish and Contractor's Model Fireplaces are only available in **White (WC)** GFRC finish.

STEP 5: (Choose Gas Shut Off & Line Location)

GAS SHUT OFF & LINE LOCATION	MODEL #
Key Valve on the RIGHT / Gas Source out the BACK	XXX-XX-X-XX-RBC
Key Valve on the LEFT / Gas Source out the BACK	XXX-XX-X-XX-LBC
Key Valve on the RIGHT / Gas Source UNDERNEATH	XXX-XX-X-XX-RUC
Key Valve on the LEFT / Gas Source UNDERNEATH	XXX-XX-X-XX-LUC

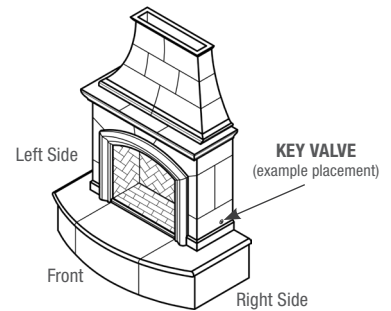

Note: All Fireplaces are crated for shipment.

Fireplace Accessories



Arched Black Scroll Screen	
Model #:	8250-BL
Price:	\$617
Compatible Fireplaces:	<ul style="list-style-type: none"> Phoenix Grand Phoenix Mariposa Grand Mariposa



Black Scroll Screen	
Model #:	8255-BL
Price:	\$773
Compatible Fireplaces:	<ul style="list-style-type: none"> Cordova Reduced Cordova Grand Cordova



Black Scroll Screen	
Model #:	8253-BL
Price:	\$617
Compatible Fireplaces:	<ul style="list-style-type: none"> Petite Cordova Grand Petite Cordova



Brooklyn Mesh Screen	
Model #:	8256-BL
Price:	\$881
Compatible Fireplaces:	<ul style="list-style-type: none"> Brooklyn Brooklyn Smooth



GFRC Chimney Rain Vent Cap	
Model #:	8017RV-XX
Price:	\$287
Compatible Fireplaces:	<ul style="list-style-type: none"> Phoenix Grand Phoenix



Arched GFRC Protector Plate	
Model #:	8200-XX
Price:	\$403
Compatible Fireplaces:	<ul style="list-style-type: none"> Phoenix Grand Phoenix Mariposa Grand Mariposa



GFRC Protector Plate	
Model #:	8210-XX
Price:	\$417
Compatible Fireplaces:	<ul style="list-style-type: none"> Cordova Reduced Cordova Grand Cordova



GFRC Protector Plate	
Model #:	8205-XX
Price:	\$403
Compatible Fireplaces:	<ul style="list-style-type: none"> Petite Cordova Grand Petite Cordova



GFRC Chimney Rain Vent Cap	
Model #:	8050RV-XX
Price:	\$320
Compatible Fireplaces:	<ul style="list-style-type: none"> Brooklyn Brooklyn Smooth

Model #:	8073RV-XX
Price:	\$301
Compatible Fireplaces:	<ul style="list-style-type: none"> Mariposa Grand Mariposa

Model #:	8022RV-XX
Price:	\$312
Compatible Fireplaces:	<ul style="list-style-type: none"> Cordova Grand Cordova Reduced Cordova

Model #:	8025RV-XX
Price:	\$301
Compatible Fireplaces:	<ul style="list-style-type: none"> Petite Cordova Grand Petite Cordova

"-xx" = Insert color code from **STEP 4** above.

STEP 6: (Choose Media Type & Corresponding Burner)

Vented & Vent Free Log Sets For Fireplaces

STYLE	MODEL #	16"	18/20"	24"	30"
Charred Oak (Vented)	CHD-xx	\$366 28#	\$412 46#	\$484 62#	\$647 78#



STYLE	MODEL #	16/20"	24"	30"
Charred Frontier Oak (Vent-Free)	CHFR-xx	\$348 35#	\$398 41#	\$495 48#



"-xx" = insert size

For a complete listing of Real Fyre® Vented and Vent-Free log sets see the Real Fyre® Price Lists **L-A3-02122** and **L-F3-02222**.

Glass, Gems, & Nuggets



See page 12 for packages, colors, and pricing.

Recommendation: One 10 lb package to fill burner pan. If your desire is to fill fireplace at a 2" depth use one 10 lb bag for every 65 sq. inches 25 lbs is recommended for the Manhattan style fireplace.

Stainless Steel Vented & Vent-Free Burner Systems for Fireplaces

VENTED BURNERS	STYLE	MODEL #	16/19"	18/20"	24"	30"
G45 Vented Stainless Steel Burner (LOGS)	Standard	G45-xx-SS (Natural gas only)	\$394 25#	\$416 27#	\$445 31#	\$513 37#
	Standard with Assembled Valve	G45-xxNA-SS or G45-xxPA-SS	\$731 27#	\$753 29#	\$783 33#	\$852 39#
G45 Vented Stainless Steel Burner (GLASS/GEMS)	Standard	G45-GL-xx-SS (Natural gas only)	\$373 20#	\$393 22#	\$418 28#	\$483 31#
	Standard with Assembled Valve	G45-GL-xxNA-SS or G45-GL-xxPA-SS	\$710 22#	\$730 24#	\$756 30#	\$821 33#



VENTED FIREPLACE / BURNER SIZE COMPATIBILITY

Vented Fireplaces	G45 Burner		G22 Burner	
	Match-Lit	w/ Valve	Match-Lit	w/ Valve
022, 023, 882, 050, 060	up to 30"	up to 24"	up to 30"	up to 24"
017, 818, 073, 868, 025, 865, 040, 045	up to 24"	up to 18/20"	up to 24"	up to 18"

VENT-FREE BURNERS	STYLE	MODEL #	16/18"	24/30"
G10 Vent-Free Stainless Steel Burner (LOGS) 16/18" 22-25# 24/30" 26-30#	Manual	G10-xx-SS	\$1,403	\$1,506
	Variable Remote *	G10-xx-15-SS	\$1,844	\$1,945
	Electronic Remote *	G10-xx-01V-SS	\$2,197	\$2,303

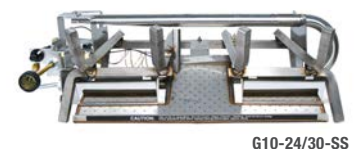

VENT-FREE BURNERS	STYLE	MODEL #	18"	24"	30"
G21 Vent-Free Contemporary Burner (GLASS/GEMS) 20-30#	Remote *	G21-GL-xx-12	\$1,394	\$1,503	\$1,566



VENT-FREE FIREPLACE / BURNER SIZE COMPATIBILITY

Vent-free Fireplaces	G10 Burner	G21 Burner
122, 123, 182, 050, 060, 150, 160	up to 24/30" w/ 30" log	up to 30"
117, 118, 173, 168, 125, 165, 140, 145	up to 24/30" w/ 24" log	up to 24"

* Remote systems include basic Transmitter and Receiver.

"-xx" = insert size

STEP 1: Choose Product - Chat Height Firetables

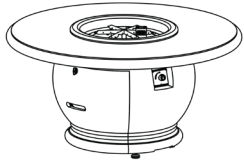

Amphora Firetable	
Model #:	610-xx-11-M2xC
Dimensions:	48" dia x 24"h
Weight (lbs):	220
Price:	\$3,242

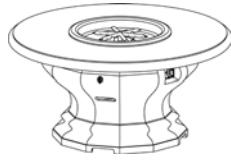

Inverted Firetable	
Model #:	629-xx-11-M2xC
Dimensions:	48" dia x 24"h
Weight (lbs):	230
Price:	\$3,242

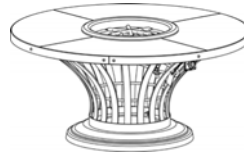

Fiesta Firetable	
Model #:	770-xx-11-M2xC
Dimensions:	54" dia x 25"h
Weight (lbs):	280
Price:	\$3,488

-Includes nylon cover for Propane tank

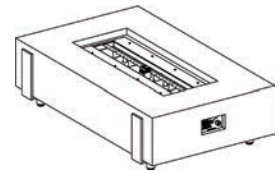

Iron Saddle Firetable *	
Model #:	580-xx-11-M7xC
Dimensions:	60"w x 36"d x 17"h
Weight (lbs):	370
Price:	\$4,979

w/ FyreStarter Ignition System †	
Model #:	580-xx-11-H7xC
Price:	\$7,415

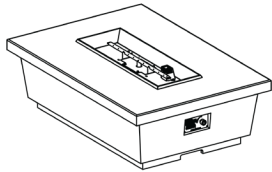

Contempo Rectangle **	
Model #:	783-xx-11-M4xC
Dimensions:	52"w x 36"d x 15½"h
Weight (lbs):	230
Price:	\$2,962

w/ FyreStarter Ignition System †	
Model #:	783-xx-11-H4xC
Price:	\$5,438

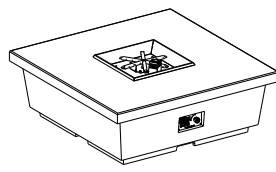

Contempo Square **	
Model #:	784-xx-11-M2xC
Dimensions:	44"w x 44"d x 15½"h
Weight (lbs):	230
Price:	\$3,109

w/ FyreStarter Ignition System †	
Model #:	784-xx-11-H2xC
Price:	\$5,580

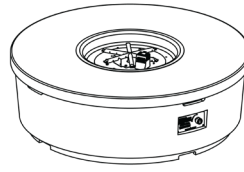

Contempo Round **	
Model #:	782-xx-11-M2xC
Dimensions:	47" dia x 15½"h
Weight (lbs):	200
Price:	\$2,966

w/ FyreStarter Ignition System †	
Model #:	782-xx-11-H2xC
Price:	\$5,359

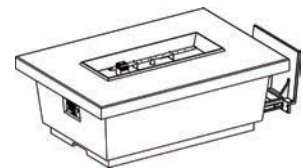

Contempo LP Select (w/ Drawer to house horizontal LP Tank)	
Model #:	785-xx-11-M4PC
Dimensions:	52"w x 36"d x 18½"h
Weight (lbs):	270
Price:	\$3,400

-Horizontal LP tank not included

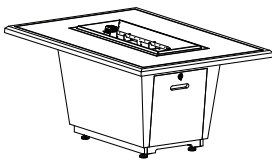

Cosmopolitan Rectangle	
Model #:	635-xx-11-M4xC
Dimensions:	54"w x 36"d x 24"h
Weight (lbs):	220
Price:	\$3,256

w/ FyreStarter Ignition System †	
Model #:	635-xx-11-H4xC
Price:	\$5,726

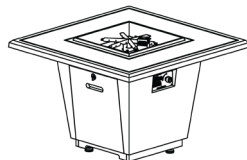

Cosmopolitan Square	
Model #:	640-xx-11-M2xC
Dimensions:	36"w x 36"d x 24"h
Weight (lbs):	160
Price:	\$2,945

w/ FyreStarter Ignition System †	
Model #:	640-xx-11-H2xC
Price:	\$5,421



Cosmopolitan Round	
Model #:	645-xx-11-M2xC
Dimensions:	48" dia x 24"h
Weight (lbs):	210
Price:	\$3,499

w/ FyreStarter Ignition System †	
Model #:	645-xx-11-H2xC
Price:	\$5,966

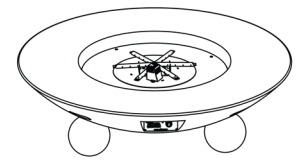

Versailles Firetable *	
Model #:	744-xx-11-M6xC
Dimensions:	54" dia x 16"h
Weight (lbs):	350
Price:	\$4,396

w/ FyreStarter Ignition System †	
Model #:	744-xx-11-H6xC
Price:	\$6,844

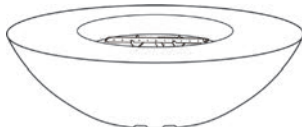

Calais Oval Firetable *	
Model #:	759-xx-11-M4xC
Dimensions:	60"w x 36"d x 18"h
Weight (lbs):	240
Price:	\$4,551

w/ FyreStarter Ignition System †	
Model #:	759-xx-11-H4xC
Price:	\$6,996

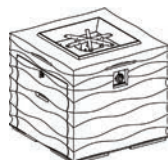

Voro Cube	
Model #:	726-xx-11-M2xC
Dimensions:	25½"w x 25½"d x 22¾"h
Weight (lbs):	170
Price:	\$3,320



Voro Firetable	
Model #:	725-xx-11-M2xC
Dimensions:	36"w x 36"d x 24"h
Weight (lbs):	190
Price:	\$3,583



Lotus Firetable *	
Model #:	653-xx-11-M2xC
Dimensions:	48" dia x 20"h
Weight (lbs):	300
Price:	\$4,997

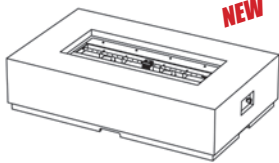

NEW

Legend Firetable *	
Model #:	581-xx-11-M7xC
Dimensions:	60"w x 36"d x 14½"h
Weight (lbs):	360
Price:	\$3,860

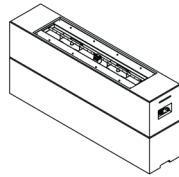

Milan Tall Linear Firetable *	
Model #:	215-xx-11-M8xC
Dimensions:	72"w x 16"d x 32"h
Weight (lbs):	360
Price:	\$4,181

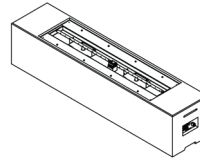

Milan Low Linear Firetable *	
Model #:	216-xx-11-M8xC
Dimensions:	72"w x 16"d x 16"h
Weight (lbs):	215
Price:	\$2,537

NEW

w/ FyreStarter Ignition System †	
Model #:	581-xx-11-H7xC
Price:	\$6,296

w/ FyreStarter Ignition System †	
Model #:	215-xx-11-H8xC
Price:	\$6,197

w/ FyreStarter Ignition System †	
Model #:	216-xx-11-H8xC
Price:	\$4,587

FIRETABLE VALVES

VALVE	DESCRIPTION	GAS	BTU's
M2	12" Star Burner	NG	60k
	12" Star Burner	LP	60k
H2	12" Star Burner w/ FyreStarter	NG	65k
	12" Star Burner w/ FyreStarter	LP	65k
M4	24" Linear Burner	NG	60k
	24" Linear Burner	LP	60k
H4	24" Linear Burner w/ FyreStarter	NG	65k
	24" Linear Burner w/ FyreStarter	LP	65k
M6	16" Star Burner	NG	65k
	16" Star Burner	LP	65k
H6	16" Star Burner w/ FyreStarter	NG	100k
	16" Star Burner w/ FyreStarter	LP	100k
M7	36" Linear Burner	NG	65k
	36" Linear Burner	LP	65k
H7	36" Linear Burner w/ FyreStarter	NG	75k
	36" Linear Burner w/ FyreStarter	LP	75k
M8	48" Linear Burner	NG	65k
	48" Linear Burner	LP	65k
H8	48" Linear Burner w/ FyreStarter	NG	100k
	48" Linear Burner w/ FyreStarter	LP	100k

M-series valves now include a **piezo igniter**.

Reclaimed Wood Chat Height Firetables

Reclaimed Wood Firetables feature two (2) table top options, **French Barrel Oak (FO)** and **Silver Pine (SP)**, plus bases with **Black Lava (BA)** finish. Must select either **French Barrel Oak** (e.g. 635-BA-FO-M4xC) or **Silver Pine** (e.g. 635-BA-SP-M4xC).

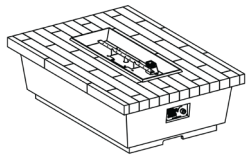

Reclaimed Wood Contempo Rectangle **	
FO Model #:	783-BA-FO-M4xC
SP Model #:	783-BA-SP-M4xC
Dimensions:	54"w x 36"d x 15½"h
Weight (lbs):	230
Price:	\$3,644

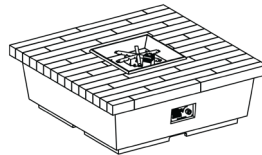

Reclaimed Wood Contempo Square **	
FO Model #:	784-BA-FO-M2xC
SP Model #:	784-BA-SP-M2xC
Dimensions:	44"w x 44"d x 15½"h
Weight (lbs):	230
Price:	\$3,796

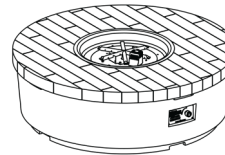

Reclaimed Wood Contempo Round **	
FO Model #:	782-BA-FO-M2xC
SP Model #:	782-BA-SP-M2xC
Dimensions:	47" dia x 15½"h
Weight (lbs):	200
Price:	\$3,487

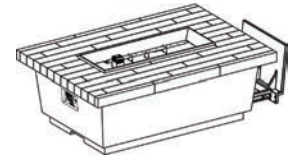

Recl. Wood Contempo LP Select (w/ Drawer to house horizontal LP Tank)	
FO Model #:	785-BA-FO-M4PC
SP Model #:	785-BA-SP-M4PC
Dimensions:	52"w x 36"d x 18½"h
Weight (lbs):	270
Price:	\$4,089

-Horizontal LP tank not included

w/ FyreStarter Ignition System †	
FO Model #:	783-BA-FO-H4xC
SP Model #:	783-BA-SP-H4xC
Price:	\$6,128

w/ FyreStarter Ignition System †	
FO Model #:	784-BA-FO-H2xC
SP Model #:	784-BA-SP-H2xC
Price:	\$6,275

w/ FyreStarter Ignition System †	
FO Model #:	782-BA-FO-H2xC
SP Model #:	782-BA-SP-H2xC
Price:	\$5,973

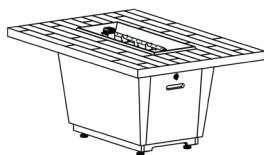

Reclaimed Wood Cosmopolitan Rectangle	
FO Model #:	635-BA-FO-M4xC
SP Model #:	635-BA-SP-M4xC
Dimensions:	54"w x 36"d x 24"h
Weight (lbs):	220
Price:	\$4,015

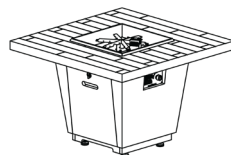

Reclaimed Wood Cosmopolitan Square	
FO Model #:	640-BA-FO-M2xC
SP Model #:	640-BA-SP-M2xC
Dimensions:	36"w x 36"d x 24"h
Weight (lbs):	160
Price:	\$3,472

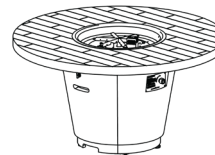

Reclaimed Wood Cosmopolitan Round	
FO Model #:	645-BA-FO-M2xC
SP Model #:	645-BA-SP-M2xC
Dimensions:	48" dia x 24"h
Weight (lbs):	210
Price:	\$4,111

w/ FyreStarter Ignition System †	
FO Model #:	635-BA-FO-H4xC
SP Model #:	635-BA-SP-H4xC
Price:	\$6,491

w/ FyreStarter Ignition System †	
FO Model #:	640-BA-FO-H2xC
SP Model #:	640-BA-SP-H2xC
Price:	\$5,958

w/ FyreStarter Ignition System †	
FO Model #:	645-BA-FO-H2xC
SP Model #:	645-BA-SP-H2xC
Price:	\$6,574

ORDERING NOTES:

1. "-xx" = Insert color from **STEP 2** on page 8.
2. * Cannot accommodate an LP tank inside the unit; selecting Propane may require Tank/End Table and Hose (see page 14).
3. ** All 782, 783, & 784 models for Propane include **5110-26** 10' Gas Hose.
4. † **FyreStarter** = Bluetooth remote control, requires 120 Volt AC Power. Includes **A** and **C** USB ports.
5. **Fire Media sold separately!** See pages 12 & 13 for available Fyre Glass, gas logs & lava fyre options.

Dining Height Firetables

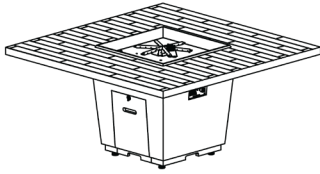

Reclaimed Wood Cosmopolitan Square Dining Firetable	
FO Model #:	642-BA-FO-M6xC
SP Model #:	642-BA-SP-M6xC
Dimensions:	60" w x 60" d x 29" h
Weight (lbs):	360
Price:	\$7,229

w/ FyreStarter Ignition System †	
FO Model #:	642-BA-FO-H6xC
SP Model #:	642-BA-SP-H6xC
Price:	\$9,622

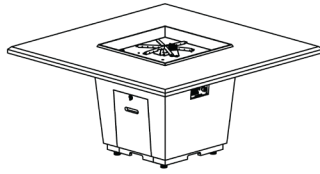

Cosmopolitan Square Dining Firetable	
Model #:	642-xx-11-M6xC
Dimensions:	60" w x 60" d x 29" h
Weight (lbs):	360
Price:	\$6,294

w/ FyreStarter Ignition System †	
Model #:	642-xx-11-H6xC
Price:	\$8,704



Fiesta Dining Firetable	
Model #:	775-xx-11-M2xC
Dimensions:	54" dia x 28" h
Weight (lbs):	290
Price:	\$3,894

-Includes nylon cover for Propane tank

DINING FIRETABLE VALVES

VALVE	DESCRIPTION	GAS	BTU's
M2	12" Star Burner	NG	60k
	12" Star Burner	LP	60k
M6	16" Star Burner	NG	65k
	16" Star Burner	LP	65k
H6	16" Star Burner w/ FyreStarter	NG	75k
	16" Star Burner w/ FyreStarter	LP	75k

M-series valves now include a piezo igniter.

ORDERING NOTES:

1. "-xx" = insert color from STEP 2.
2. † FyreStarter = Bluetooth remote control, requires 120 Volt AC Power. Includes **A** and **C** USB ports.
3. **Fire Media sold separately!** See pages 12 & 13 for available Fyre Glass, gas logs & lava fyre options.

STEP 2: Choose Color Option(s)

FINISH COLORS	MODEL #
White Aspen	xxx- WA -xx-xxxC
Café Blanco	xxx- CB -xx-xxxC
Black Lava	xxx- BA -xx-xxxC
Smoke	xxx- SM -xx-xxxC

ANTIQUE FINISHES	MODEL #
Travertine	xxx- TR -xx-xxxC
Dark Basalt	xxx- DB -xx-xxxC
Light Basalt	xxx- LB -xx-xxxC

- American Fyre Designs™ products are individually handcrafted, the finishes listed are subject to slight texture and color variation.
- American Fyre Designs™ reserves the right to change or discontinue finishes without prior notice. Samples available upon request.

STEP 3: Choose Gas Option

GAS OPTIONS	MODEL #
Natural Gas	xxx-xx-xx-xx NC
Propane Gas	xxx-xx-xx-xx PC

Note: All Firetables, Fire Bowls, & Fire Pits are crated for shipment.

Fire Bowls

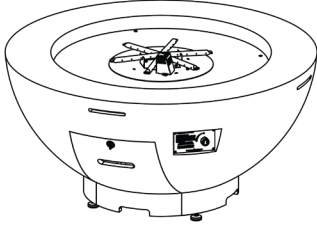

48" Fire Bowl	
Model #:	731-xx-11-M6xC
Dimensions:	48" dia x 22"h
Weight (lbs):	250
Price:	\$3,717

w/ FyreStarter Ignition System †	
Model #:	731-xx-11-H6xC
Price:	\$6,178

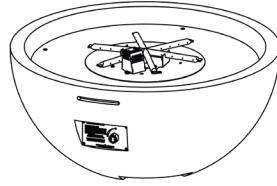

36" Fire Bowl *	
Model #:	732-xx-11-M6xC
Dimensions:	36" dia x 16"h
Weight (lbs):	154
Price:	\$2,638

w/ FyreStarter Ignition System †	
Model #:	732-xx-11-H6xC
Price:	\$5,119

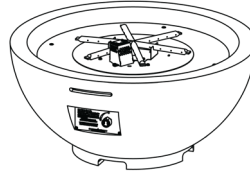

32" Fire Bowl *	
Model #:	733-xx-11-M6xC
Dimensions:	32" dia x 16"h
Weight (lbs):	109
Price:	\$2,474

w/ FyreStarter Ignition System †	
Model #:	733-xx-11-H6xC
Price:	\$4,959

FIRE BOWL VALVES

VALVE	DESCRIPTION	GAS	BTU's
M2	12" Star Burner	NG	60k
	12" Star Burner	LP	60k
M4	24" Linear Burner	NG	60k
	24" Linear Burner	LP	60k
H4	24" Linear Burner w/ FyreStarter	NG	65k
	24" Linear Burner w/ FyreStarter	LP	65k
M6	16" Star Burner	NG	65k
	16" Star Burner	LP	65k
H6	16" Star Burner w/ FyreStarter	NG	100k
	16" Star Burner w/ FyreStarter	LP	100k

M-series valves now include a piezo igniter.

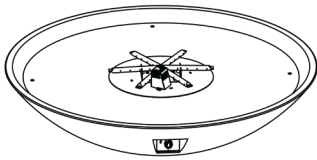

48" Marseille Fire Bowl *	
Model #:	751-xx-11-M6xC
Dimensions:	48" dia x 10½"h
Weight (lbs):	195
Price:	\$2,773

w/ FyreStarter Ignition System †	
Model #:	751-xx-11-H6xC
Price:	\$5,252

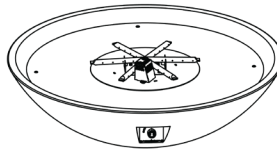

40" Marseille Fire Bowl *	
Model #:	752-xx-11-M6xC
Dimensions:	40" dia x 10½"h
Weight (lbs):	150
Price:	\$2,367

w/ FyreStarter Ignition System †	
Model #:	752-xx-11-H6xC
Price:	\$4,855

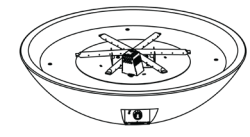

32" Marseille Fire Bowl *	
Model #:	753-xx-11-M6xC
Dimensions:	32" dia x 8½"h
Weight (lbs):	90
Price:	\$2,096

with Water Spout	
Model #:	753-xx-80-M6xC
Price:	\$2,581

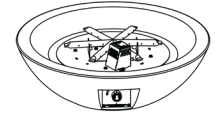

24" Marseille Fire Bowl *	
Model #:	755-xx-11-M2xC
Dimensions:	24" dia x 6½"h
Weight (lbs):	45
Price:	\$1,824

Note: Bowls with Water Spouts are **not available** with FyreStarter ignition.

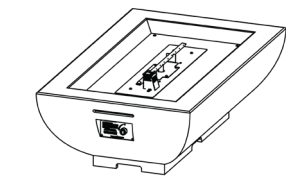

Bordeaux Rectangle Fire Bowl *	
Model #:	435-xx-11-M4xC
Dimensions:	50"w x 30"d x 16¼"h
Weight (lbs):	205
Price:	\$3,987

w/ FyreStarter Ignition System †	
Model #:	435-xx-11-H4xC
Price:	\$6,442

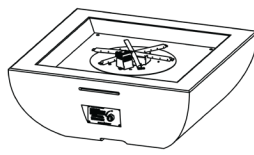

Bordeaux Square Fire Bowl *	
Model #:	430-xx-11-M6xC
Dimensions:	36"w x 36"d x 15¼"h
Weight (lbs):	180
Price:	\$3,309

w/ FyreStarter Ignition System †	
Model #:	430-xx-11-H6xC
Price:	\$5,777

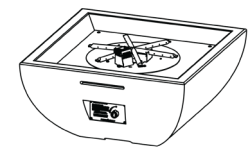

Bordeaux Petite Square Fire Bowl *	
Model #:	431-xx-11-M6xC
Dimensions:	30"w x 30"d x 12¼"h
Weight (lbs):	140
Price:	\$3,036

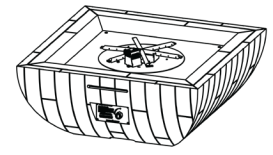

Reclaimed Wood Bordeaux Square Fire Bowl *	
FO Model #:	430-FO-FO-M6xC
SP Model #:	430-SP-SP-M6xC
Dimensions:	36"w x 36"d x 15¼"h
Weight (lbs):	180
Price:	\$3,987

ORDERING NOTES:

1. "-xx" = Insert color from **STEP 2** on page 11.
2. * Cannot accommodate an LP tank inside the unit; selecting Propane may require Tank/End Table and Hose (see page 14).
3. † **FyreStarter** = Bluetooth remote control, requires 120 Volt AC Power. Includes **A** and **C** USB ports.
4. **Fire Media sold separately!** See pages 12 & 13 for available Fyre Glass, gas logs & lava fyre options.

Fire Pits

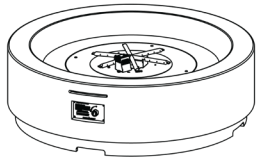

Louvre Round Fire Pit *	
Model #:	686-xx-11-M6xC
Dimensions:	48" dia x 15¼"h
Weight (lbs):	220
Price:	\$3,990

w/ FyreStarter Ignition System †	
Model #:	686-xx-11-H6xC
Price:	\$6,467

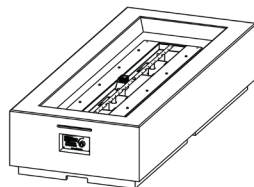

Louvre Long Rectangle Fire Pit *	
Model #:	688-xx-11-M8xC
Dimensions:	72¼"w x 30¼"d x 15¼"h
Weight (lbs):	260
Price:	\$4,547

w/ FyreStarter Ignition System †	
Model #:	688-xx-11-H8xC
Price:	\$7,012

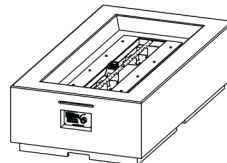

Louvre Rectangle Fire Pit *	
Model #:	689-xx-11-M7xC
Dimensions:	56¼"w x 30¼"d x 15¼"h
Weight (lbs):	215
Price:	\$3,990

w/ FyreStarter Ignition System †	
Model #:	689-xx-11-H7xC
Price:	\$6,467

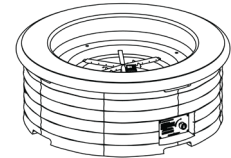

Chiseled Fire Pit *	
Model #:	680-xx-11-M6xC
Dimensions:	39" dia x 14½"h
Weight (lbs):	235
Price:	\$3,551

w/ FyreStarter Ignition System †	
Model #:	680-xx-11-H6xC
Price:	\$6,036

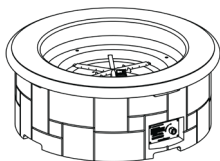

El Dorado Fire Pit *	
Model #:	681-xx-11-M6xC
Dimensions:	39" dia x 14½"h
Weight (lbs):	210
Price:	\$3,551

w/ FyreStarter Ignition System †	
Model #:	681-xx-11-H6xC
Price:	\$6,036

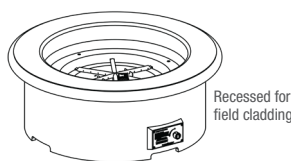

Contractor's Model Fire Pit *	
Model #:	685-xx-11-M6xC
Dimensions:	39" dia x 14½"h
Weight (lbs):	190
Price:	\$2,865

w/ FyreStarter Ignition System †	
Model #:	685-xx-11-H6xC
Price:	\$5,365

FIRE PIT VALVES

VALVE	DESCRIPTION	GAS	BTU's
M6	16" Star Burner	NG	65k
	16" Star Burner	LP	65k
H6	16" Star Burner w/ FyreStarter	NG	100k
	16" Star Burner w/ FyreStarter	LP	100k
M7	36" Linear Burner	NG	65k
	36" Linear Burner	LP	65k
H7	36" Linear Burner w/ FyreStarter	NG	75k
	36" Linear Burner w/ FyreStarter	LP	75k
M8	48" Linear Burner	NG	65k
	48" Linear Burner	LP	65k
H8	48" Linear Burner w/ FyreStarter	NG	100k
	48" Linear Burner w/ FyreStarter	LP	100k

M-series valves now include a **piezo igniter**.

Lanterns

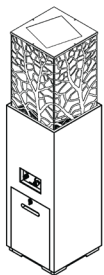

Magnolia Lantern ‡	
Model #:	716-xx-11-M1xC
Dimensions:	16"w x 16"d x 66"h
Weight (lbs):	160
Price:	\$2,760

w/ FyreStarter Ignition System †	
Model #:	716-xx-11-H1xC
Price:	\$5,220

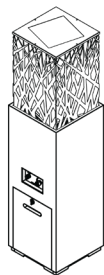

Nest Lantern ‡	
Model #:	715-xx-11-M1xC
Dimensions:	16"w x 16"d x 66"h
Weight (lbs):	160
Price:	\$2,760

w/ FyreStarter Ignition System †	
Model #:	715-xx-11-H1xC
Price:	\$5,220

LANTERN VALVES

VALVE	DESCRIPTION	GAS	BTU's
M1	Lantern Burner	NG	25k
	Lantern Burner	LP	23k
H1	Lantern Burner w/ FyreStarter	NG	28k
	Lantern Burner w/ FyreStarter	LP	27k

M-series valves now include a **piezo igniter**.

‡ Magnolia and Nest Lanterns may not use Reflective Fyre Glass or Diamond Nuggets. See Page 12 for available Glass Media.

ORDERING NOTES:

1. "-xx" = Insert color from **STEP 2** on page 11.
2. * Cannot accommodate an LP tank inside the unit; selecting Propane may require Tank/End Table and Hose (see page 14).
3. † **FyreStarter** = Bluetooth remote control, requires 120 Volt AC Power. Includes **A** and **C** USB ports.
4. **Fire Media sold separately!** See pages 12 & 13 for available Fyre Glass, gas logs & lava fyre options.

Fire Urns & Lanterns

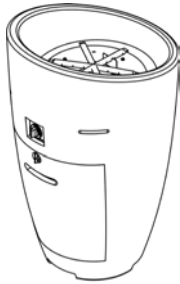

Eclipse Fire Urn	
Model #:	520-xx-11-M2xC
Dimensions:	23" dia x 37½"h
Weight (lbs):	170
Price:	\$2,509

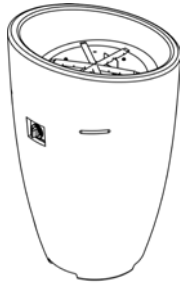

Eclipse Fire Urn* (without access door)	
Model #:	520-xx-10-M2NC
Dimensions:	23" dia x 37½"h
Weight (lbs):	170
Price:	\$2,378

-Natural Gas only.



Wave Fire Urn	
Model #:	530-xx-11-M2xC
Dimensions:	20" dia x 37½"h
Weight (lbs):	150
Price:	\$2,509



Wave Fire Urn* (without access door)	
Model #:	530-xx-10-M2NC
Dimensions:	20" dia x 37½"h
Weight (lbs):	150
Price:	\$2,378

-Natural Gas only.

FIRE URN VALVES

VALVE	DESCRIPTION	GAS	BTU's
M2	12" Star Burner	NG	60k
	12" Star Burner	LP	60k

M-series valves now include a **piezo igniter**.

STEP 2: Choose Color Option(s)

FINISH COLORS	MODEL #
White Aspen	xxx-WA-xx-xxxC
Café Blanco	xxx-CB-xx-xxxC
Black Lava	xxx-BA-xx-xxxC
Smoke	xxx-SM-xx-xxxC

ANTIQUE FINISHES	MODEL #
Travertine	xxx-TR-xx-xxxC
Dark Basalt	xxx-DB-xx-xxxC
Light Basalt	xxx-LB-xx-xxxC

RECLAIMED WOOD FINISHES	MODEL #
French Barrel Oak	xxx-FO-FO-xxxC
Silver Pine	xxx-SP-SP-xxxC

"Reclaimed Wood" finish options are only available for the Bordeaux Square Fire Bowl (430 model).

- American Fyre Designs™ products are individually handcrafted, the finishes listed are subject to slight texture and color variation.
- American Fyre Designs™ reserves the right to change or discontinue finishes without prior notice. Samples available upon request.

STEP 3: Choose Gas Option

GAS OPTIONS	MODEL #
Natural Gas	xxx-xx-xx-xxNC
Propane Gas	xxx-xx-xx-xxPC

Note: All Firetables, Fire Bowls, & Fire Pits are crated for shipment.

Fyre Glass

COLORS	5 lb. Package \$49.00	7.5 lb. Package \$74.00	10 lb. Package \$98.00	10 lb. Jar \$106.00	10 lb. Jar 6-Pack \$635.00	40 lb. Bucket \$392.00
Azuria	GL-5-F	GL-7-F	GL-10-F	GL-10J-F	GL-10J-F-6	GL-40-F
Black	GL-5-B	GL-7-B	GL-10-B	GL-10J-B	GL-10J-B-6	GL-40-B
Bronze	GL-5-Z	GL-7-Z	GL-10-Z	GL-10J-Z	GL-10J-Z-6	GL-40-Z
Caribbean Blue	GL-5-N	GL-7-N	GL-10-N	GL-10J-N	GL-10J-N-6	GL-40-N
Clear	GL-5-C	GL-7-C	GL-10-C	GL-10J-C	GL-10J-C-6	GL-40-C
Emerald	GL-5-E	GL-7-E	GL-10-E	GL-10J-E	GL-10J-E-6	GL-40-E
Star Fyre	GL-5-W	GL-7-W	GL-10-W	GL-10J-W	GL-10J-W-6	GL-40-W



FYRE GLASS

Reflective Fyre Glass

COLORS	5 lb. Package \$55.00	7.5 lb. Package \$80.00	10 lb. Package \$107.00	10 lb. Jar \$114.00	10 lb. Jar 6-Pack \$687.00	40 lb. Bucket \$423.00
Azuria Reflective	GL-5-FR	GL-7-FR	GL-10-FR	GL-10J-FR	GL-10J-FR-6	GL-40-FR
Black Reflective	GL-5-BR	GL-7-BR	GL-10-BR	GL-10J-BR	GL-10J-BR-6	GL-40-BR
Bronze Reflective	GL-5-ZR	GL-7-ZR	GL-10-ZR	GL-10J-ZR	GL-10J-ZR-6	GL-40-ZR
Caribbean Blue Refl.	GL-5-NR	GL-7-NR	GL-10-NR	GL-10J-NR	GL-10J-NR-6	GL-40-NR
Copper Reflective	GL-5-QR	GL-7-QR	GL-10-QR	GL-10J-QR	GL-10J-QR-6	GL-40-QR
Emerald Reflective	GL-5-ER	GL-7-ER	GL-10-ER	GL-10J-ER	GL-10J-ER-6	GL-40-ER
Gold Reflective	GL-5-HR	GL-7-HR	GL-10-HR	GL-10J-HR	GL-10J-HR-6	GL-40-HR
Champagne Reflective	GL-5-CR	GL-7-CR	GL-10-CR	GL-10J-CR	GL-10J-CR-6	GL-40-CR

Fyre Gems

COLORS	5 lb. Package \$43.00	7.5 lb. Package \$63.00	10 lb. Package \$82.00	10 lb. Jar \$91.00	10 lb. Jar 6-Pack \$545.00	40 lb. Bucket \$325.00
Black Pearl	GLG-5-J	GLG-7-J	GLG-10-J	GLG-10J-J	GLG-10J-J-6	GLG-40-J
Blue Topaz	GLG-5-T	GLG-7-T	GLG-10-T	GLG-10J-T	GLG-10J-T-6	GLG-40-T
Champagne	GLG-5-D	GLG-7-D	GLG-10-D	GLG-10J-D	GLG-10J-D-6	GLG-40-D
Deep Amber	GLG-5-A	GLG-7-A	GLG-10-A	GLG-10J-A	GLG-10J-A-6	GLG-40-A
Emerald	GLG-5-E	GLG-7-E	GLG-10-E	GLG-10J-E	GLG-10J-E-6	GLG-40-E
Glacier	GLG-5-C	GLG-7-C	GLG-10-C	GLG-10J-C	GLG-10J-C-6	GLG-40-C
Sapphire	GLG-5-S	GLG-7-S	GLG-10-S	GLG-10J-S	GLG-10J-S-6	GLG-40-S
Ruby	GLG-5-RY	GLG-7-RY	GLG-10-RY	GLG-10J-RY	GLG-10J-RY-6	GLG-40-RY



FYRE GEMS

Diamond Nuggets

COLORS	5 lb. Package \$48.00	7.5 lb. Package \$72.00	10 lb. Package \$94.00	10 lb. Jar \$102.00	10 lb. Jar 6-Pack \$611.00	40 lb. Bucket \$377.00
Clear	GLD-5-C	GLD-7-C	GLD-10-C	GLD-10J-C	GLD-10J-C-6	GLD-40-C
Steel Blue	GLD-5-SB	GLD-7-SB	GLD-10-SB	GLD-10J-SB	GLD-10J-SB-6	GLD-40-SB
Rosé	GLD-5-R	GLD-7-R	GLD-10-R	GLD-10J-R	GLD-10J-R-6	GLD-40-R
Emerald	GLD-5-E	GLD-7-E	GLD-10-E	GLD-10J-E	GLD-10J-E-6	GLD-40-E
Pacific Blue	GLD-5-PB	GLD-7-PB	GLD-10-PB	GLD-10J-PB	GLD-10J-PB-6	GLD-40-PB
Deep Black	GLD-5-DB	GLD-7-DB	GLD-10-DB	GLD-10J-DB	GLD-10J-DB-6	GLD-40-DB
Black Luster	GLD-5-BL	GLD-7-BL	GLD-10-BL	GLD-10J-BL	GLD-10J-BL-6	GLD-40-BL



DIAMOND NUGGETS

Recommended Amount of Glass Media to Purchase (in addition to the included base media) *

ITEM DESCRIPTION	AMT.
Nest Lantern (715), Magnolia Lantern (716) (NOTE: Nest and Magnolia Lanterns may not use Reflective Glass or Diamond Nuggets)	6 lbs
Cosmo Rect. Firetable (635), Cosmo Square Firetable (640), Voro (725), Voro Cube (726), Contempo Rect. Firetable (783), Contempo Square Firetable (784), Contempo LP Select (785)	10 lbs
Amphora (610), Inverted (629), Cosmo Round Firetable (645), Fiesta Firetable (770), Fiesta Dining Firetable (775), Contempo Round Firetable (782), 24" Marseille Fire Bowl (755), Wave Urn (530)	20 lbs
Iron Saddle Firetable (580), Legend Firetable (581)	25 lbs
Lotus Firetable (653), Chiseled Fire Pit (680) (low setting), El Dorado Fire Pit (681) (low setting), Contractor's Model Fire Pit (685) (low setting), Bordeaux Petite Square Fire Bowl (431), 32" Fire Bowl (733), Manhattan Fireplace (082), Eclipse Urn (520)	30 lbs
Milan Tall Linear Firetable (215), Milan Low Linear Firetable (216), Milan Tall Linear Fireplace (211-TA), Milan Low Linear Fireplace (211-L0)	35 lbs
Cosmo Sq. Dining Firetable (642), Bordeaux Square Fire Bowl (430), 32" Marseille Fire Bowl (753), Calais Oval Firetable (759)	40 lbs
Louvre Rectangle Fire Pit (689), Bordeaux Rectangle Fire Bowl (435), 36" Fire Bowl (732)	50 lbs
Louvre Long Rectangle Fire Pit (688), 54" Versailles Firetable (744), Chiseled Fire Pit (680) (high setting), El Dorado Fire Pit (681) (high setting), Contractor's Model Fire Pit (685) (high setting)	60 lbs
Louvre Round Fire Pit (686), 48" Fire Bowl (731)	70 lbs
40" Marseille Fire Bowl (752)	80 lbs
48" Marseille Fire Bowl (751)	110 lbs

*All AFD firetables, fire pits, and fire bowls along with Manhattan fireplace **include a 10# or 5# bag of lava granules (LF-10 or LF-5)** to serve as base media. Not included with Nest Lantern, Magnolia Lantern, Eclipse, or Wave fire urns.

Fyre Spheres

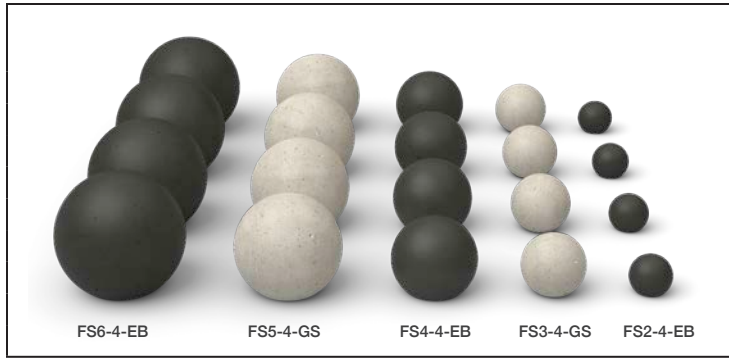

DESCRIPTION	COLOR	MODEL #	PRICE
2" Fyre Spheres (4 in a box)	Epic Black	FS2-4-EB	\$37
	Graystone	FS2-4-GS	34
3" Fyre Spheres (4 in a box)	Epic Black	FS3-4-EB	47
	Graystone	FS3-4-GS	43
4" Fyre Spheres (4 in a box)	Epic Black	FS4-4-EB	55
	Graystone	FS4-4-GS	50
5" Fyre Spheres (4 in a box)	Epic Black	FS5-4-EB	81
	Graystone	FS5-4-GS	74
6" Fyre Spheres (4 in a box)	Epic Black	FS6-4-EB	126
	Graystone	FS6-4-GS	115

Gas Log Sets, Stones & Lava



GAS LOGS, STONES & LAVA	MODEL #	PRICE
Back Country Oak †	BCO-27	\$627
Desert Sage †	DS-27	627
Prairie Oak †	PRO-27	591
Campfyre Logs, Wood Chips †	OCL-34	376
Beachwood Logs, Stones †	OCBW-34	417
Desert Sage Branches	BDS-2	121
Charred Branches	BDC-4	118
36-Pc. Wood Chunks	WCD-36	307
10-Pc. River Rock Fyre Stones	STN-10	135
20-Pc. River Rock Fyre Stones	STN-20	315
140-Pc. Creekstones, Greige	CSTN-20-G	344
140-Pc. Creekstones, Cloud	CSTN-20-C	344
140-Pc. Creekstones, Mixed (Greige & Cloud)	CSTN-20-CG	344
140-Pc. Creekstones, Black	CSTN-20-B	398
Volcanic Stones (25 lbs)	VS-25	104
Volcanic Stones (12 lbs)	VS-12	64
Lava Fyre Coals (10 lbs)	LFC-10	44
Lava Fyre Granules (10 lbs)	LF-10	37
Lava Fyre Granules (5 lbs)	LF-5	23

†Lava needs to be ordered separately

† Log sets pictured with recommended Lava Granules or Lava Coals. Lava Granules & Lava Coals are not included with log set and must be ordered separately. Additional River Rock and accessories available. See Peterson Real Fyre® Price List# L-A3-02122

Recommended Amount of Lava Media (Granules & Coals) to Purchase (in addition to the included base media) *

ITEM DESCRIPTION	AMT.
Cosmopolitan Rectangle Firetable (635), Cosmopolitan Square Firetable (640), Cosmopolitan Round Firetable (645), Voro Firetable (725), Voro Cube (726), Contempo Round Firetable (782), Contempo Rectangle Firetable (783), Contempo Square Firetable (784), Contempo LP Select (785), 24" Marseille Fire Bowl (755), Iron Saddle Firetable (580), Legend Firetable (581)	10 lbs
Amphora Firetable (610), Inverted Firetable (629), Lotus Firetable (653), Fiesta Firetable (770), Fiesta Dining Firetable (775), Wave Urn (530), Bordeaux Petite Square Fire Bowl (431), Manhattan Fireplace (082)	15 lbs
Eclipse Urn (520), Chiseled Fire Pit (680) (low setting), El Dorado Fire Pit (681) (low setting), Contractor's Model Fire Pit (685) (low setting), Bordeaux Square Fire Bowl (430), 32" Marseille Fire Bowl (753), Milan Tall Linear Firetable (215), Milan Low Linear Firetable (216), Calais Oval Firetable (759), Milan Tall Linear Fireplace (211-TA), Milan Low Linear Fireplace (211-LO)	20 lbs
Cosmopolitan Square Dining Firetable (642), 32" Fire Bowl (733), Iron Saddle Firetable (580)	25 lbs
Louvre Rectangle Fire Pit (689), Chiseled Fire Pit (680) (high setting), El Dorado Fire Pit (681) (high setting), Contractor's Model Fire Pit (685) (high setting), Bordeaux Rectangle Fire Bowl (435), 36" Fire Bowl (732), 54" Versailles Firetable (744)	30 lbs
48" Fire Bowl (731)	35 lbs
Louvre Round Fire Pit (686), Louvre Long Rectangle Fire Pit (688), 40" Marseille Fire Bowl (752)	40 lbs
48" Marseille Fire Bowl (751)	50 lbs

*All AFD firetables, fire pits, and fire bowls along with Manhattan fireplace include a 10# or 5# bag of lava granules (LF-10 or LF-5) to serve as base media. Not included with Nest Lantern, Magnolia Lantern, Eclipse, or Wave fire urns.

Lava Media may not be used with Lanterns.

Vinyl Protective Covers

PRODUCT DESCRIPTION - (Model Prefix)	MODEL #	PRICE
FIREPLACES		
Milan Low Linear - (211-L0)	8145A	\$177
Milan Tall Linear - (211-TA)	8145A	\$177
FIRETABLES		
Amphora - (610)	8135A	\$139
Inverted - (629)	8135A	\$139
Fiesta - (770)	8131A	\$99
Iron Saddle - (580)	8152A	\$124
Legend - (581)	8152A	\$124
Contempo Rectangle - (783)	8139A	\$121
Contempo Square - (784)	8146A	\$108
Contempo Round - (782)	8143A	\$107
Contempo LP Select - (785)	8139A	\$121
Cosmopolitan Rectangle - (635)	8138A	\$138
Cosmopolitan Square - (640)	8132A	\$78
Cosmopolitan Round - (645)	8135A	\$139
Calais Oval - (759)	8151A	\$122
Voro - (725)	8132A	\$78
Lotus - (653)	8143A	\$107
Milan Tall Linear - (215)	8144A	\$170
Cosmopolitan Square Dining - (642)	8137A	\$203
Fiesta Dining - (775)	8131A	\$99
FIRE PITS		
48" Louvre - (686)	8143A	\$107
Louvre Long Rectangle - (688)	8149A	\$146
Louvre Rectangle - (689)	8150A	\$127
Fire Pits - (680, 681, 685)	8140A	\$107
FIRE BOWLS		
48" Fire Bowl - (731)	8135A	\$139
Fire Bowls - (732, 752)	8140A	\$107
Fire Bowls - (733, 753)	8142A	\$85
48" Marseille - (751)	8143A	\$107
Bordeaux Rectangle - (435)	8148A	\$122
Bordeaux Square - (430, 431)	8132A	\$78
FIRE URNS & LANTERNS		
Eclipse - (520)	8141A	\$79
Wave - (530)	8141A	\$79
Nest & Magnolia - (715)	8134A	\$107
Propane Tank Nylon Cover	5110-13-20	\$60

GFRC Covers

RECLAIMED WOOD

PRODUCT DESCRIPTION - (Model Prefix)	MODEL #	PRICE	MODEL #	PRICE
FIRETABLES				
Amphora - (610)	8100-XX	\$174	N/A	
Inverted - (629)	8100-XX	\$174		
Fiesta - (770)	8100-XX	\$174		
Iron Saddle - (580)	8115-XX	\$375		
Legend - (581)	8115-XX	\$375		
Contempo Rectangle - (783)	8110-XX	\$205	8110-F0 (-SP)	\$281
Contempo Square - (784)	8120-XX	\$174	8120-F0 (-SP)	\$231
Contempo Round - (782)	8100-XX	\$174	8100-F0 (-SP)	\$231
Contempo LP Select - (785)	8110-XX	\$205	8110-F0 (-SP)	\$281
Cosmopolitan Rectangle - (635)	8110-XX	\$205	8110-F0 (-SP)	\$281
Cosmopolitan Square - (640)	8120-XX	\$174	8120-F0 (-SP)	\$231
Cosmopolitan Round - (645)	8100-XX	\$174	8100-F0 (-SP)	\$231
Voro - (725, 726)	8120-XX	\$174		
Lotus - (653)	Included		N/A	
Cosmopolitan Square Dining - (642)	8123-XX	\$259	8123-F0 (-SP)	\$308
Fiesta Dining - (775)	8100-XX	\$174	N/A	

"-xx" = insert color from Pg. 13 colors



Tank/End Tables & Extension Hose

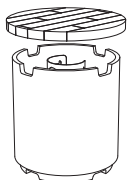

Reclaimed Wood Contempo Tank/End Table *
FO Model #: 8510-BA-F0
SP Model #: 8510-BA-SP
Dimensions: 20¾" dia x 19¼" h
Price: \$468

Contempo Tank/End Table *
Model #: 8510-xx
Dimensions: 20¾" dia x 19¼" h
Price: \$392

10 ft. LP Extension Hose w/ Elbow Fitting
Model #: 5110-26
Dimensions: 10 ft. long
Price: \$103

* Propane tank and hose not included.

"-xx" = insert color from Pg. 13 colors.

Tempered Glass Wind Guards

DESCRIPTION	SIZE	COMPATIBLE MODELS	MODEL #	PRICE
Square Wind Guard	19¼" w x 19¼" d x 6¾" h	640, 725, 784	8202-WG	\$380
Rectangular Wind Guard	35" w x 14½" d x 6¾" h	635, 783, 785	8204-WG	445
Round Wind Guard	26" dia x 6¾" h	All Round Firetables (excluding Versailles)	8208-WG	486
Large Square Wind Guard	28" w x 28" d x 6¾" h	642	8210-WG	550
Milan Wind Guard	51½" w x 14½" d x 6¾" h	215, 216	8212-WG	620
Large Rectangular Wind Guard	43" w x 19¼" d x 6¾" h	580, 581	8211-WG	584

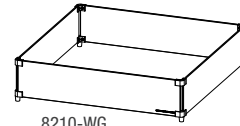
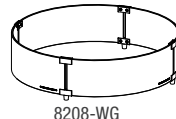
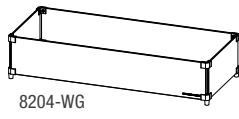
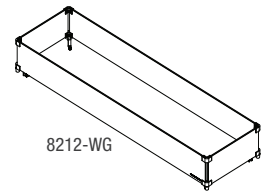

Gas Conversion Kits

Model Prefix	FYRESTARTER VALVE		MANUAL FLAME SENSING CONTROL VALVE		AWEIS VALVE (Pre 2022)		PUSH-TO-TURN (Pre 2021)		KEY VALVE (Pre 2021)	
	LP to NG	NG to LP	LP to NG	NG to LP	LP to NG	NG to LP	LP to NG	NG to LP	LP to NG	NG to LP
FIRETABLES										
610, 629, 725, 726	N/A		MCK-01-NAT \$66	MCK-01-LP \$72	N/A		CK-11-NAT \$62	CK-13-LP \$62	CK-20-NAT \$62	CK-22-LP \$62
770, 775	N/A		MCK-01-NAT \$66	MCK-10-LP \$72	N/A		CK-11-NAT \$62	CK-13-LP \$62	CK-20-NAT \$62	CK-22-LP \$62
783, 784, 782	HCK-02-NAT \$170	HCK-02-LP \$170	MCK-02-NAT \$33	MCK-02-LP \$33	CK-81-NAT \$24	CK-85-LP \$32	CK-12-NAT \$15	CK-15-LP \$24	CK-21-NAT \$15	CK-24-LP \$24
785	N/A		MCK-02-NAT \$33	MCK-02-LP \$33	N/A		N/A		N/A	
759	HCK-02-NAT \$170	HCK-02-LP \$170	MCK-02-NAT \$33	MCK-02-LP \$33	N/A		CK-12-NAT \$15	CK-15-LP \$24	CK-21-NAT \$15	CK-24-LP \$24
640, 645	HCK-01-NAT \$216	HCK-01-LP \$209	MCK-01-NAT \$66	MCK-01-LP \$72	CK-79-NAT \$81	CK-83-LP \$66	CK-11-NAT \$62	CK-13-LP \$62	CK-20-NAT \$62	CK-22-LP \$62
635	HCK-01-NAT \$216	HCK-09-LP \$199	MCK-01-NAT \$66	MCK-09-LP \$66	CK-79-NAT \$81	CK-82-LP \$66	CK-11-NAT \$62	CK-14-LP \$62	CK-20-NAT \$62	CK-23-LP \$62
653	N/A		MCK-02-NAT \$33	MCK-02-LP \$33	N/A		CK-12-NAT \$15	CK-15-LP \$24	CK-21-NAT \$15	CK-24-LP \$24
642	HCK-08-NAT \$209	HCK-08-LP \$195	MCK-03-NAT \$66	MCK-03-LP \$72	CK-80-NAT \$81	CK-84-LP \$103	CK-51-NAT \$62	CK-53-LP \$62	CK-55-NAT \$62	CK-57-LP \$62
744	HCK-04-NAT \$170	HCK-04-LP \$170	MCK-04-NAT \$33	MCK-04-LP \$33	CK-72-NAT \$24	CK-74-LP \$32	CK-52-NAT \$15	CK-54-LP \$24	CK-56-NAT \$15	CK-58-LP \$24
215, 216	HCK-07-NAT \$195	HCK-07-LP \$195	MCK-06-NAT \$53	MCK-06-LP \$53	CK-76-NAT \$32	CK-78-LP \$47	N/A		N/A	
580, 581	HCK-06-NAT \$195	HCK-06-LP \$199	MCK-06-NAT \$53	MCK-06-LP \$53	N/A		N/A		N/A	
FIRE PITS										
680, 681, 685, 686	HCK-04-NAT \$170	HCK-04-LP \$170	MCK-04-NAT \$33	MCK-04-LP \$33	CK-72-NAT \$24	CK-74-LP \$32	CK-52-NAT \$15	CK-54-LP \$24	CK-56-NAT \$15	CK-58-LP \$24
689	HCK-06-NAT \$195	HCK-06-LP \$199	MCK-06-NAT \$53	MCK-06-LP \$53	CK-95-NAT \$62	CK-96-LP \$62	CK-87-NAT \$15	CK-88-LP \$15	CK-89-NAT \$24	CK-90-LP \$15
688	HCK-07-NAT \$195	HCK-07-LP \$195	MCK-06-NAT \$53	MCK-06-LP \$53	CK-76-NAT \$32	CK-78-LP \$47	CK-91-NAT \$81	CK-92-LP \$47	CK-93-NAT \$62	CK-94-LP \$47
FIRE BOWLS										
753, 431, 755	N/A		MCK-04-NAT \$33	MCK-04-LP \$33	N/A		CK-52-NAT \$15	CK-54-LP \$24	CK-56-NAT \$15	CK-58-LP \$24
732, 733, 751, 752	HCK-04-NAT \$170	HCK-04-LP \$170	MCK-04-NAT \$33	MCK-04-LP \$33	CK-72-NAT \$24	CK-74-LP \$32	CK-52-NAT \$15	CK-54-LP \$24	CK-56-NAT \$15	CK-58-LP \$24
430	HCK-04-NAT \$170	HCK-04-LP \$170	MCK-04-NAT \$33	MCK-04-LP \$33	N/A		CK-52-NAT \$15	CK-54-LP \$24	CK-56-NAT \$15	CK-58-LP \$24
435	HCK-02-NAT \$170	HCK-02-LP \$170	MCK-02-NAT \$33	MCK-02-LP \$33	N/A		CK-12-NAT \$15	CK-15-LP \$24	CK-21-NAT \$15	CK-24-LP \$24
731	HCK-03-NAT \$216	HCK-03-LP \$235	MCK-03-NAT \$66	MCK-03-LP \$72	CK-71-NAT \$81	CK-73-LP \$92	CK-51-NAT \$62	CK-53-LP \$62	CK-55-NAT \$62	CK-57-LP \$62
FIRE URNS & LANTERNS										
520, 530	N/A		MCK-01-NAT \$66	MCK-01-LP \$72	N/A		CK-11-NAT \$62	CK-13-LP \$62	CK-20-NAT \$62	CK-22-LP \$62
715, 716	HCK-05-NAT \$209	HCK-05-LP \$209	MCK-05-NAT \$66	MCK-05-LP \$66	N/A		CK-16-NAT \$62	CK-17-LP \$62	CK-25-NAT \$62	CK-26-LP \$62

American Fyre Designs Burners

BURNER DESCRIPTION	MODEL #	BTU's		PRICE
		N.G.	L.P.	
12" Star Burner * (Without Valve) LP	OCBS-12P	--	50k	\$119
12" Star Burner * (Without Valve) NAT	OCBS-12	60k	--	119
16" Star Burner ** (Without Valve) LP	OCBS-16P	--	60k	139
16" Star Burner ** (Without Valve) NAT	OCBS-16	65k	--	139
24" Linear Straight Burner * (Without Valve) LP	OCBL-24P	--	50k	170
24" Linear Straight Burner * (Without Valve) NAT	OCBL-24	60k	--	170

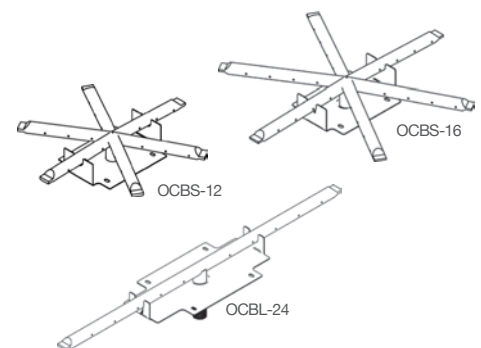

* Also used as replacement for most firetables on pages 6, 7 & 8.

** Also used as replacement for 54" Versailles Firetable (pg. 6), Cosmo. Square Dining (pg. 8), most Fire Bowls (pg. 9), and most Fire Pits (pg. 10).

FIREPLACE PART NUMBER BREAK DOWN & ORDERING GUIDE

882

Fireplace Style
PAGE 2-3

-

35

Hearth Style
PAGE 2

-

N

Recess Option
N = No Recess
H = Hearth Only
A = Hearth & Body

-

CB

Color Choice
PAGE 4

-

RB

Gas Shut Off
PAGE 4

C

Crating

Follow these step-by-step guidelines to configure the right fireplace for you.

Step 1 - Fireplace Style - Select your fireplace style (vented or vent-free).

Step 2 - Hearth Style - The fireplace rests on a hearth base – select the size and style that suits your application.

Step 3 - Recess Option - Some AFD fireplaces may be clad with your own finishing materials like stone or brick. For these units, you may select the “recess” option to accommodate such materials.

Step 4 - Color Choice - Choose your finish which comes in five finish color options.

Step 5 - Gas Shut Off & Line Location - Determine where your gas shut off control and line should be positioned.

Step 6 - Select Media Type and Burner - logs or glass media in natural gas or propane suitable for fireplace chosen (vented or vent-free)

- Optional fireplace accessories shown on page 4 & 5 - consider adding a cover, screen or rain cap.
- Note: All fireplaces are crated for shipment.

FIRETABLES, PITS, BOWLS, & URNS PART NUMBER BREAK DOWN & ORDERING GUIDE

782

Fire Feature Style
PAGE 6-11

-

CB

Color Choice
PAGE 11

-

11

Top Style
11 = GFRC
FO = French Barrel Oak
SP = Silver Pine

-

M2

Valves
H = FyreStarter
M = Manual Flame Sensing Control w/ piezo igniter

N

Gas Type
N = Natural
P = Propane

C

Crating

Follow these step-by-step guidelines to configure the right product for you.

Step 1 - Fire Feature Style - Select the AFD fire feature you desire.

Step 2 - Color Choice - Choose your finish which comes in five finish color options and three antique finish options.

Step 3 - Top Style - Choose your top style (available for select firetable models only).

Step 4 - Gas Type - Choose either Natural gas (N) or propane (P).

Step 5 - Select Media Type - Gas logs, stones, lava, or glass media.

- Consider adding a cover - see page 14.
- Note: All firetables, fire pits, fire bowls, and fire urns are crated for shipment.

ALL AMERICAN Fyre Designs™ PRODUCTS ARE MADE TO ORDER AND CANNOT BE CANCELED.

American Fyre Designs™ products are certified to ANSI Z21.97-2017 and CSA 2.41 as outdoor decorative gas appliances.

AFD PRODUCTS ARE FOR OUTDOOR USE ONLY

AMERICAN Fyre Designs™ LIMITED WARRANTY HIGHLIGHTS

THREE (3) YEAR WARRANTY

American Fyre Designs™ exterior (GFRC) Fireplaces, Firetables, Fire Bowls, Fire Urns, and Fire Pits are warranted for three (3) years.

ONE (1) YEAR WARRANTY

American Fyre Designs™ burners, electronic components, and valves are warranted for one (1) year.

This warranty applies to the original purchaser with invoice or proof of purchase and to single family residential use only. For additional information regarding this warranty, or to place a warranty claim contact your authorized AFD dealer

This price list may not be copied, photocopied, reproduced, translated, or published in any electronic or machine-readable form in whole or in part without prior written approval of Robert H. Peterson Co.

RH PETERSON CO.

14724 Proctor Ave • City of Industry, CA 91746 • Website: www.rhpeterson.com • (626) 369-5085 • Fax (626) 369-5979