



FPB30SGT / FPB30TBT / FPB32SGT / FPB32TBT

Fire Bowl Setup

Requires Kingsman FP2085 Round Fire Pit



All Fire Bowl (Bola) products are warranted against manufacturing defects for one year. Should your Kingsman product experience damage due to a manufacturing defect, Kingsman will replace the damaged product free of charge (proof of purchase is required). Installation, labor, and freight are not included. This warranty does not include splitting, chipping, cracking or other damage that may be caused by impact, abrasion, overloading or improper installation.

TABLE OF CONTENTS

Fire Bowl Warranty.....	3
Table Of Contents.....	3
Warnings.....	3
Fire Bowl Setup.....	4-6
Kingsman Outdoor Fire Pit Media Section.....	7-8

Fire Bowl Cover- Accessory for Fire Bowl.....	9
FPB32TRG Trim Ring – Accessory for Fire Bowl.....	10
Safety Information and Manual Lighting Instructions.....	11
Lighting Instructions and Troubleshooting Guide.....	12-13

 **WARNINGS**

- Children and adults should be alerted to the hazards of high surface temperatures and should stay away to avoid burns or clothing ignition.
- Young children should be carefully supervised when they are in the area of the appliance.
- Clothing or other flammable materials should not be hung from the appliance, or placed on or near the appliance.
- Any guard or other protective device removed for servicing the appliance must be replaced prior to operating the appliance.
- Installation and repair should be done by a qualified service person. The appliance should be inspected before use and at least annually by a qualified service person. More frequent cleaning may be required as necessary. It is imperative the control compartment, burners and circulating air passageways of the appliance be kept clean.
- Inspect the fuel supply connection (including the hose for LP Propane models) before each use of the appliance.
- If it is evident there is excessive abrasion or wear, or the hose is cut, it must be replaced prior to the appliance being put into operation.
- Cylinders must be stored outdoors in a well-ventilated area out of the reach of children. Disconnected cylinders must have threaded valve plugs tightly installed and must not be stored in a building, garage or any other enclosed area.
- Storage of this appliance indoors is permissible only if it has been disconnected from its fuel supply (Natural gas line or LP Propane gas cylinder).

LP PROPANE GAS WARNINGS

- The LP Propane gas supply cylinder used with LP models must be constructed and marked in accordance with the specifications for LP Propane gas cylinders of the U.S. Department of Transportation (DOT).
- The pressure regulator and hose assembly supplied with LP Propane models must be used. Replacement pressure regulators and hose assemblies must be those specified in this manual.
- The LP Propane gas cylinder supply system must be arranged for vapor withdraws.
- The LP Propane gas cylinder used must include a collar to protect the cylinder valve.
- When an LP Propane model is not in use, the LP Propane gas must be turned off at the supply cylinder.
- Fuel Supply line must not come into contact with surfaces having temperatures in excess of 140°F. LP gas cylinder must be kept a minimum of 4.5 feet from the appliance.
- You must use an approved LP Propane cylinder retention device.

 **WARNING:**
DO NOT LEAVE FIRE PIT UNATTENDED WHEN IN USE

 **WARNING:**
Failure to position the parts in accordance with these diagrams or failure to use only parts specifically approved with this appliance may result in property damage or personal injury.



THE INSTALLATION OF THIS KIT MUST ONLY BE UNDERTAKEN BY A QUALIFIED AND CERTIFIED GAS APPLIANCE INSTALLER.

PARTS LIST:

- Fire Bowl
- Mounting Plate with Backplate
- [1] Bag MLR1410 – ¼” Lava Rock (20LBS)
- Leg Extension Set (3 Leg Pieces, 3 Cross Braces)
- Filler Strip Ring (3 Pieces - Assembled)
- Bag of Hardware (3 Machine Screws & Nuts, 3 DT Screws)

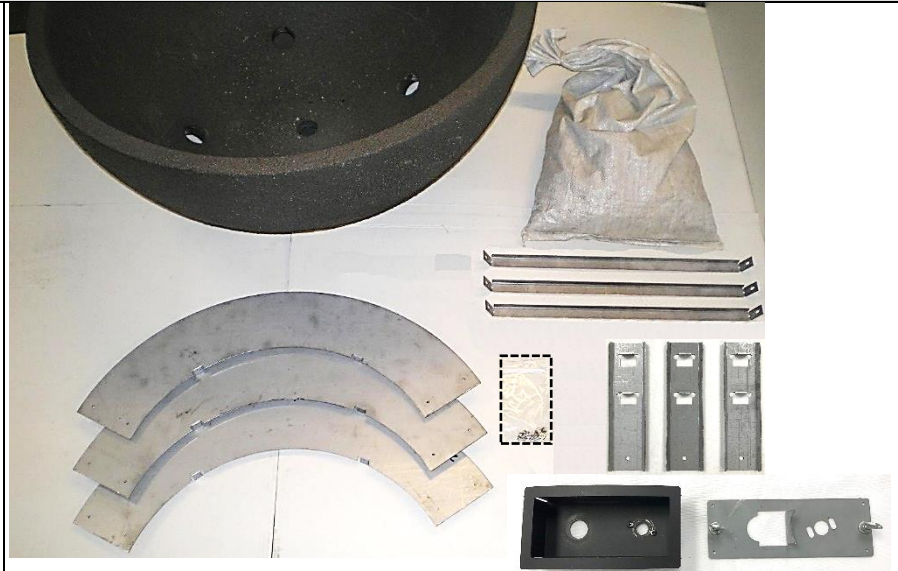

1. Invert Fire Pit and attach Leg Extensions to Fire Pit with [3] DT Screws. Attach [3] cross braces to Leg Extensions with hardware provided.

NOTE: Support sides of Fire Pit when inverted so that Igniter Electrode does not become damaged. Gap must be maintained at 1/4” - 3/8”.

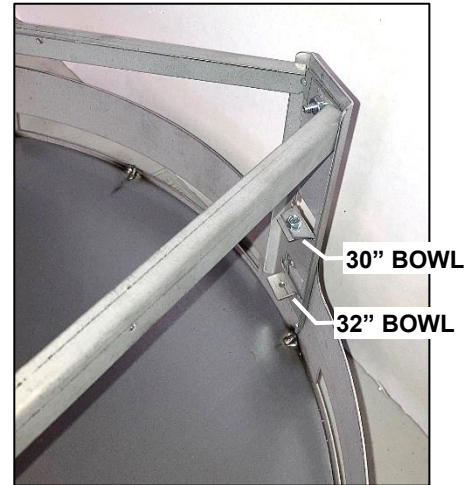
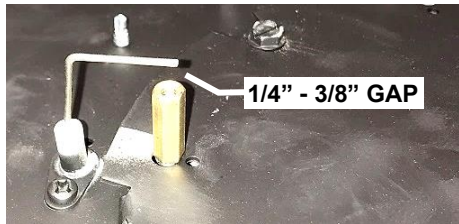

NOTE: The Leg Extensions have 2 mount positions for the FP2085 Fire Pit:

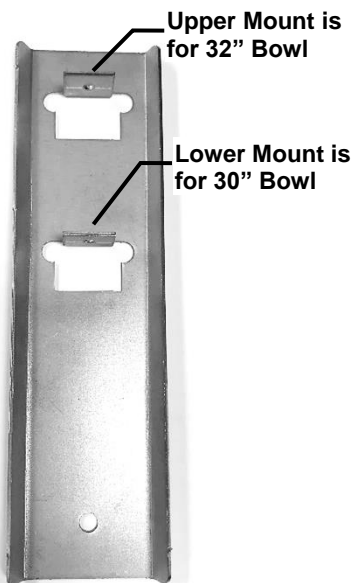

**FPB30TBT / FPB30SGT
30” Bowl**

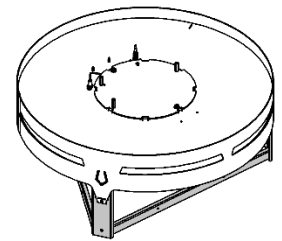
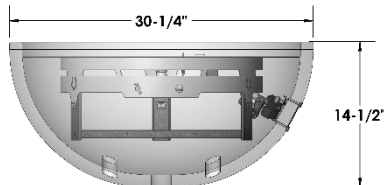
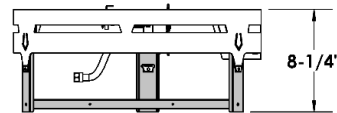

**FPB32TBT / FPB32SGT
32” Bowl**

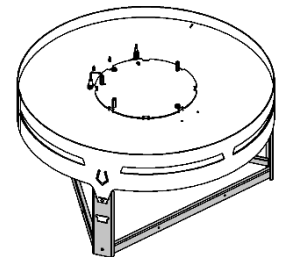
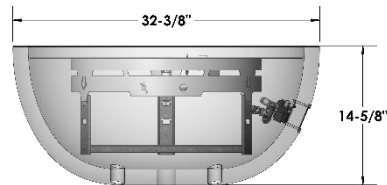
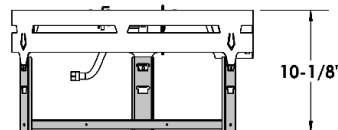

2. Disconnect LP Propane Hose from Valve Assembly if connected. Remove Valve and Push Button Igniter from Instrument Panel. Route Valve and Push Button Igniter lines to the right of the original location on the Fire Pit.

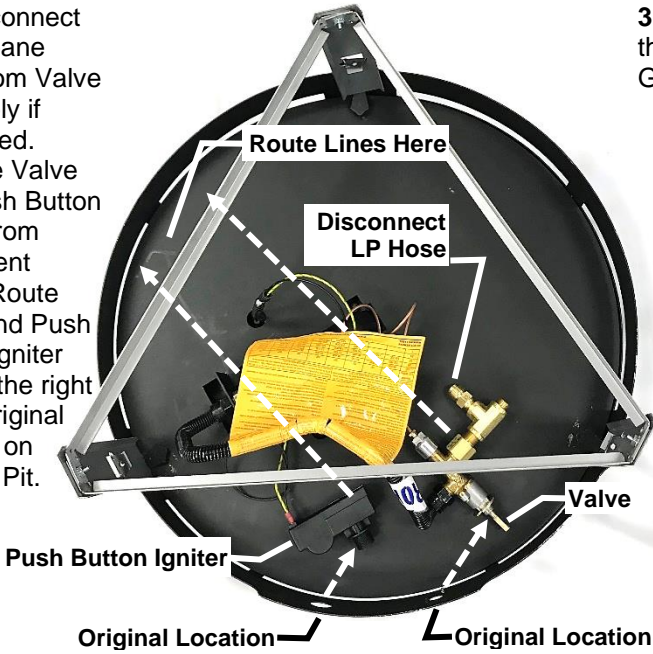

3. Insert gas supply line into Fire Bowl through one of the bottom holes. Place Fire Pit into Fire Bowl. Connect Gas Supply to Valve.

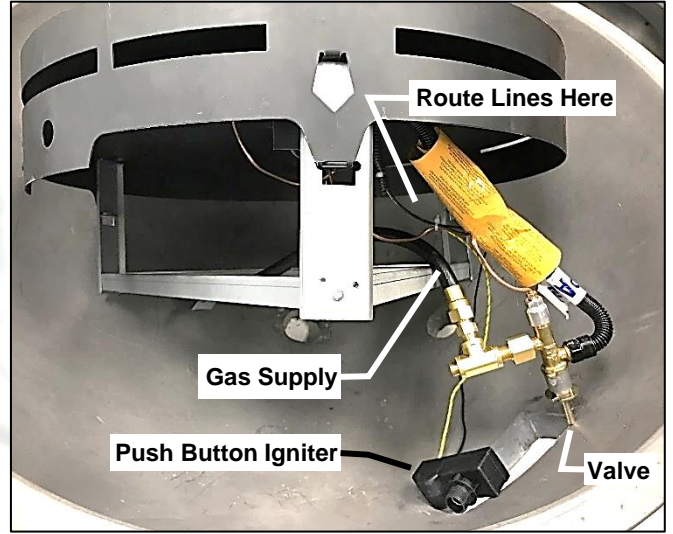

4. Insert Push Button Igniter through Backplate. Place Mounting Plate into opening in Fire Bowl. Secure Igniter with retaining nut. Next insert Valve through Backplate and secure with retaining nut. Tighten thumbscrews on Backplate.

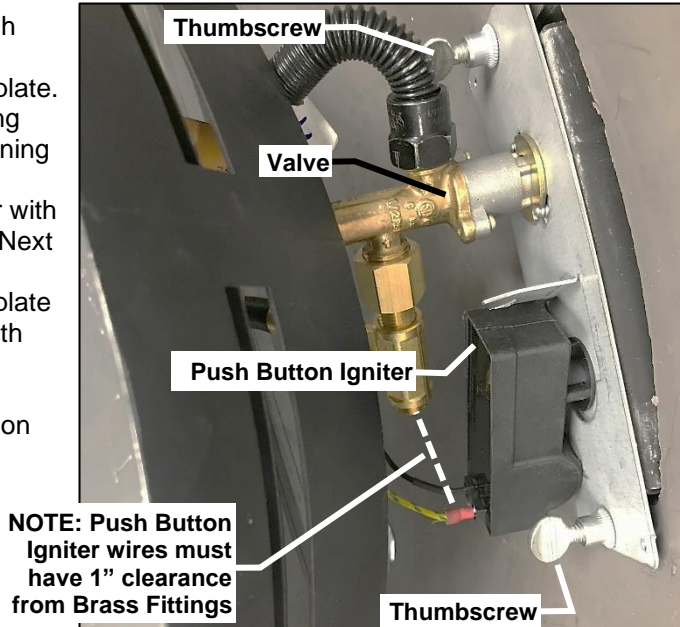

Backplate
PN # 30FPB-121T

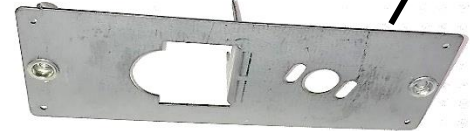

Mounting Plate
PN # 30FPB-120A

5. Install battery and cap onto Push Button Igniter. Install knob onto valve.



6. Assemble Filler Strip Ring and place onto Fire Pit.



7. Refer to *Kingsman Outdoor Fire Pit Media Section* for media options.



Kingsman Outdoor Fire Pit Media Section

MEDIA REQUIREMENTS OPTIONS: (When not using LOGC85 Log Set)

20 LBS of Glass Required for Fire Pits, if using the Fire Bowl add an additional 10-15LBS of Glass.

One bag of MQSTONE may be used for the Fire Pit, if using the Fire Bowl an additional bag may be used.

One [10LB] bag of 1/4" Lava Rock is required for the Fire Pit and an additional [10LB] bag for the Fire Bowl (2-10LB bags of 1/4" Lava Rock are supplied with Fire Bowl) may be used to fill the entire Bowl with the same material.

REQUIRED AMOUNT OF MEDIA			
ACCESSORY ITEM	FP2785 Rectangular Fire Pit	FP2085 Round Fire Pit Only	FP2085 Round Fire Pit With Fire Bowl
ROCKS			
*MLR1410 - 1/4" Lava Rock 10 LBS	10 LBS (1 BAG)	10 LBS (1 BAG)	20 LBS *(2 BAGS)

*Fire Bowl Includes: 1/4" Lava Rock – 10LBS

-MQ DEALERS ONLY-			
MQSTONE - Decorative Stones	1 BAG	1 BAG	2 BAGS

NOTE: The MQSTONE requires a Glass or Lava Rock Base.

GLASS			
MQG5W - 1/2" White Glass 5LBS	20LBS (4 BAGS)	20LBS (4 BAGS)	30-35LBS (6-7 BAGS)
MQG5C - 1/2" Bronze Glass 5LBS	20LBS (4 BAGS)	20LBS (4 BAGS)	30-35LBS (6-7 BAGS)
MQG5A - 1/2" Cobalt Blue Glass 5LBS	20LBS (4 BAGS)	20LBS (4 BAGS)	30-35LBS (6-7 BAGS)
MQG5B - 1/2" Black Glass 5LBS	20LBS (4 BAGS)	20LBS (4 BAGS)	30-35LBS (6-7 BAGS)
MQG10C - 1/4" Reflective Bronze Glass 10 LBS	20LBS (2 BAGS)	20LBS (2 BAGS)	30-35LBS (3-4 BAGS)
MQG10B - 1/4" Black Glass 10 LBS	20LBS (2 BAGS)	20LBS (2 BAGS)	30-35LBS (3-4 BAGS)

Media Examples Shown Below.



FP2085 Without Media



1/4" Lava Rock (1 Bag – 10LBS)



1/4" Lava Rock & 3/4" Lava Rock (Supplied with Fire Pit).
(1/4" Lava Rock is used as Base.)



1/4" Reflective Bronze Glass - (20LBS)



MQSTONE with 1/4" Lava Rock Base - (10LBS)



MQSTONE with 1/4" Bronze Glass Base - (20LBS)

NOTE: MQSTONE Requires a Glass or Lava Rock Base.

Fire Bowl Cover – Accessory for Fire Bowl

FPB30COVB Cover for FPB30TBT & FPB30SGT

Caring for your Fire Pit Cover

The key to keeping your outdoor fabric looking great and extending its life is periodic cleaning followed by repellency treatment. Mildew can be a problem for any outdoor fabric. Mildew will not grow on a clean synthetic fabric. Combined with humidity, the dirt and debris, which accumulate on and in the fabric, create the ideal conditions for mildew propagation. Thus, keeping outdoor fabric both clean and dry is essential to eliminate or minimize mildew growth.

- * Brush surfaces with soft brush to remove soil.
- * Soak with warm, soapy water (not to exceed 100 degrees Fahrenheit).
- * Use a mild soap such as Ivory, or Dawn. Do not use detergents, abrasives or cleaners.
- * Rinse fabric thoroughly after cleaning.
- * Let fabric air dry after rinsing
- * Do not machine dry.



Treating your Fabric

* Before "retreating" or "protecting" a fabric, the fabric must be thoroughly cleaned. Fabric protector products bond most effectively to perfectly clean fabric. Anything not removed from the fabric will interfere with the bonding and performance of the product. All dirt, body oils, sweat, soap residue will impede bonding and performance.

* Do not over spray. Saturation is not necessary. The surface needs to be slightly damp, but not soaked. Two lighter coats are better than one heavy coat. An even coating is more likely with two applications. Let the first coating dry to the touch before applying the second - generally an hour.

* The quicker you can get a fabric protector product to dry, the better bonding and performance you will achieve. It is best to treat the fabrics in warm weather, such as a hot day in full sun.

* Maintenance is essential. You can lightly mist the surface every 6 months to check the water repellency. Friction will wear away product more quickly leaving the fabric unprotected. If this is the case, such areas can be spot treated to renew repellency.

* Just a note - Silicone water repellents are not true "fabric protectors". While they do develop good repellency, they often retain a tackiness that attracts dirt. Silicone treated fabrics soil much more rapidly than untreated fabrics, have no resistance to oil-based stains, and can make fabrics more difficult to clean once soiled.

Fabric Guard

Recommended as the best fabric protectant 303® High Tech Fabric Guard™ is a premium patented formula that restores fabrics lost water and stain repellency. Yearly maintenance with 303 Products will add to the life of your fabrics.

FPB32TRG Trim Ring for FPB30TBT / FPB30SGT / FPB32SGT

Contents of Kit: [1] Trim Ring c/w [3] screws installed

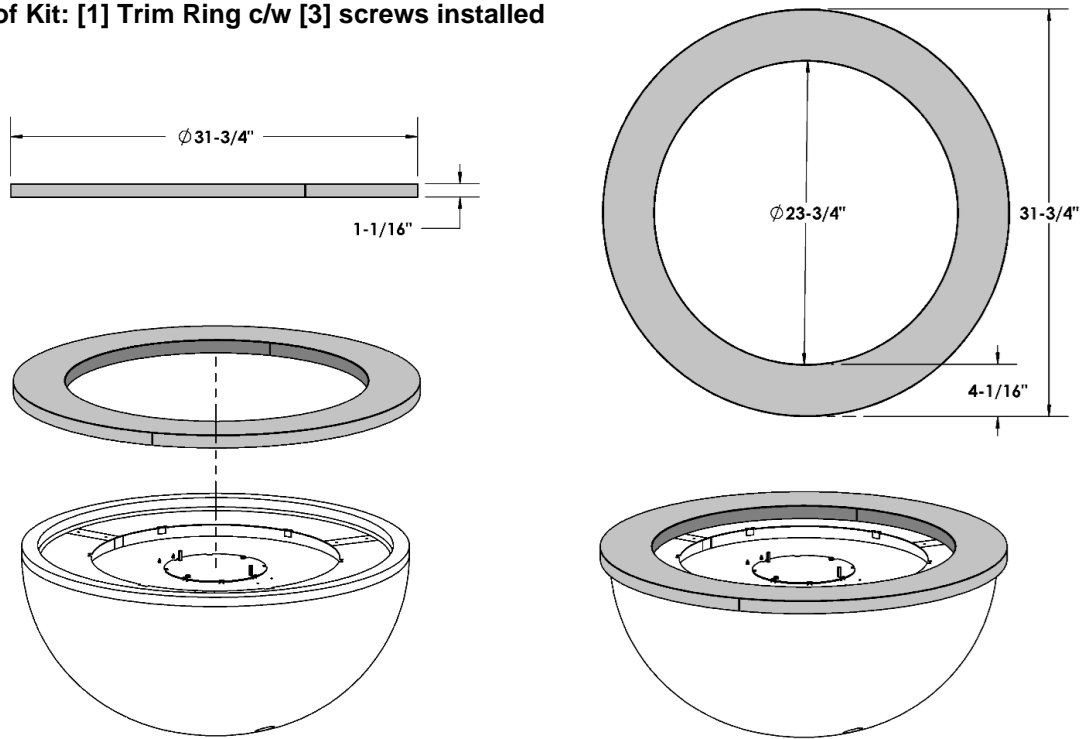

Instructions:

FPB30TBT & FPB30SGT: Place Trim Ring over concrete bowl. Screws are not required.

FPB32SGT: Place Trim Ring over concrete bowl. Tighten screws until they touch the concrete bowl. **DO NOT OVER TIGHTEN SCREWS.**

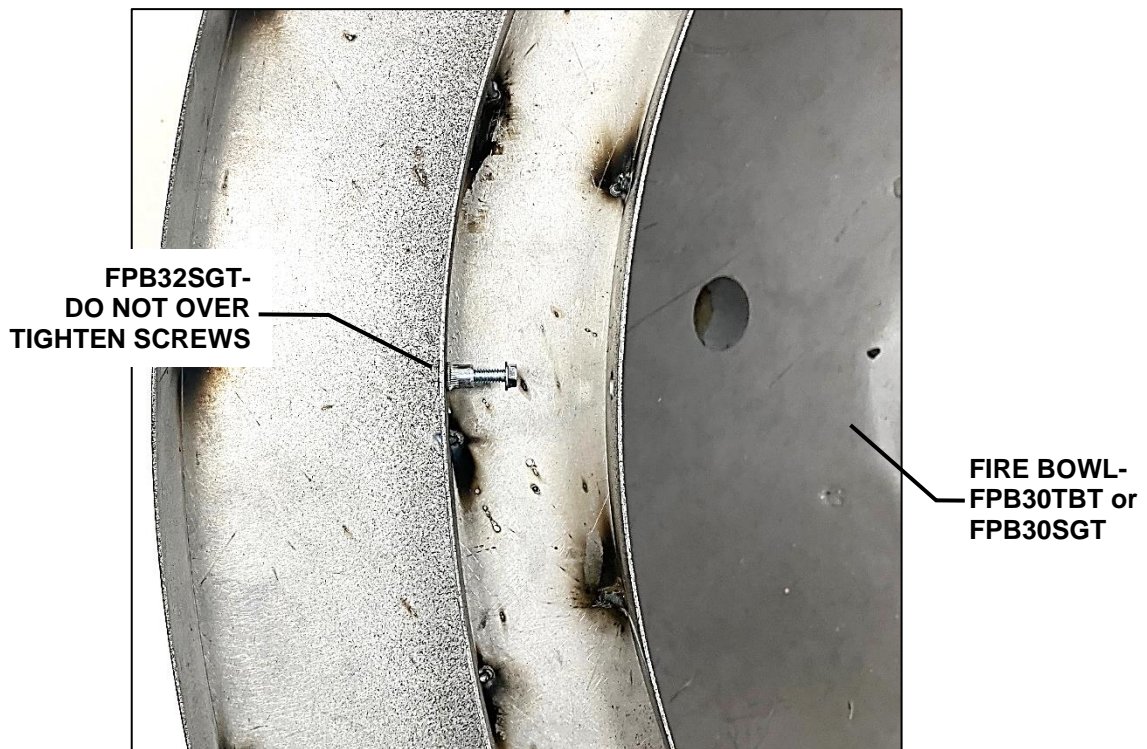

- BOTTOM VIEW OF TRIM RING INSTALLED ON BOWL -

Safety Information and Manual Lighting Instructions

FOR YOUR SAFETY READ BEFORE LIGHTING

⚠WARNING: If you do not follow these instructions exactly, a fire or explosion may result causing property damage, personal injury or loss of life.

- A. This appliance must be lit by hand. When lighting, follow these instructions exactly.
- B. Before LIGHTING, smell all around the appliance area for gas. Be sure to smell next to the floor, because some gas is heavier than air and will settle on the floor.
- C. Use only your hand to turn the gas control knob or valve. Never use tools. If the valve will not turn by hand, don't try to repair it, call a qualified service technician. Force or attempted repair may result in a fire or explosion.
- D. Do not use this appliance if any part has been underwater. Immediately call a qualified service technician to inspect the appliance, and to replace any part which has been underwater.

WHAT TO DO IF YOU SMELL GAS

- Do not try to light any appliance.
- Do not touch any electric switch; do not use any phone in your building.
- Immediately call your gas supplier from a neighbor's phone. Follow the gas supplier's instructions.
- If you cannot reach your gas supplier, call the fire department.

Manual Valve with Push Button Ignition

1. STOP! Read the safety information above.
2. Remove the top cover.
3. Find the manual gas control valve and push button igniter.
4. Turn ON gas supply.
5. Push and hold the button on the igniter and ensure sparking is occurring at the probes inside the burner tray.
6. Push in and turn the valve knob ON .
7. Gas should ignite within 10 seconds or less. If the burner does not light turn the gas to off.
8. Wait at least five (5) minutes to clear out any gas. Then smell for gas, including near the floor. If you smell gas, STOP!
9. If you don't smell gas, repeat step 4.

To Turn Off Gas Appliance

1. Turn the on/off valve to the off position at the unit for natural gas unit. For LP unit, turn the on/off valve to the off position at the unit and then turn the valve on the LP tank to the off position clockwise.
2. Replace the top cover.

-FP2085/FP2785 Thermocouple Valve Systems-

NOTE: A Thermocouple has been added as a safety feature. This will shut off the manual gas valve if the flame is extinguished for any reason.

- The thermocouple must be engulfed by the flame in order to maintain proper operation. If the thermocouple is not surrounded by the flame, the burner will shut down.
- **The thermocouple must have no more than a single layer of media (lava rock or glass) around it.**

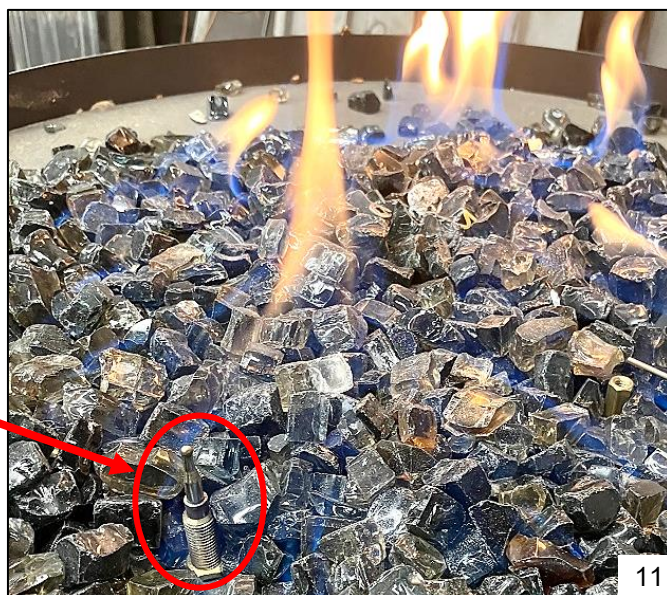

- FP2785T & FP2085T Thermocouple Equipped Fire Pits - Lighting Instructions and Troubleshooting Guide

To Light the Fire Pit:

1. Depress the valve knob with your hand (do not use tools or other devices that may cause damage). Turn the knob counterclockwise approximately 90° from the start point. Release the knob. If you can turn the knob further counterclockwise, but hit a stop which does not allow you to go back to the start point when turning clockwise, you are in the correct position.



2. With the knob against the stop point, you are at the low flame height set point. Locate the igniter push button and depress it to begin the igniter sparking.



3. (a) Once the igniter is sparking, depress the gas valve knob to allow the flow of gas to begin. The flame should ignite within 2-15 seconds. If the flame ignites and remains present, skip ahead to step 4. If the flame does not ignite release the gas valve knob and igniter button and proceed to step 3(b).

(b) If you have depressed the igniter button and gas valve knob as above but the burner flame has not ignited after 15 seconds, immediately release the gas valve knob and igniter button and allow a sufficient

amount of time for the dissipation of gas from the area, as accumulated gas can be extremely dangerous and cause serious injury or even result in fatalities. It is recommended to allow 10-15 minutes of time to pass before attempting to light the appliance again. Longer periods may be required if the appliance is in an enclosed area blocking wind and air from circulating around it. It is recommended to use a fan in restricted areas to help clear the area of residual gas before attempting to relight the appliance. Natural gas is lighter than atmospheric air, and will tend to rise and collect in higher areas, while propane is heavier than atmospheric air, and will accumulate in lower areas.

(c) Once adequate time has passed and steps have been taken to dissipate any residual gas, inspect the igniter rod and thermocouple. Ensure that the media in the combustion area is not piled up and/or covering around the igniter and thermocouple locations. Both should be covered with a minimum of one layer of media, but still visible (see below).

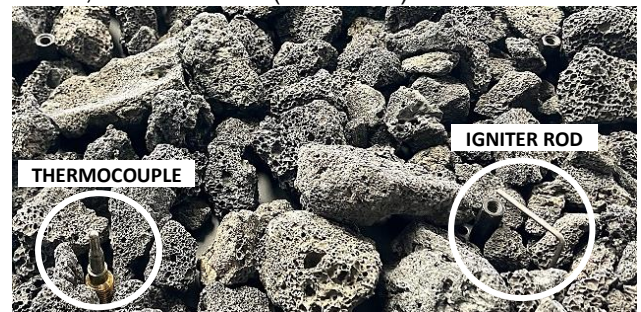

Also ensure that the igniter rod has not become bent and that it is not touching the brass stud below it. There should be an approximately 1/4" to 3/8" gap between the igniter rod and the brass stud. If no spark is present, check to ensure that wiring is properly connected to the igniter rod and there are no cracks or exposed bare wire. Also change the battery in the igniter if necessary.

(d) Repeat step 3(a). If flame fails to ignite, repeat steps 3(b), 3(c), and 3(d). However, it is recommended that you contact a qualified technician to properly and safely address the issue.

4. (a) Once you have visually confirmed that the flame is present in the combustion area, continue to keep the gas valve knob depressed and allow the flame to heat the thermocouple. After approximately 15-30 seconds, slowly release the gas valve knob. Once fully released the flame should continue to be present and continue to run. If the flame is present, continue to step 5. If the flame goes out, go to step 3(b) and follow the steps from there back to the present point in the process.

(CONTINUED ON OTHER SIDE)

(b) With the gas valve knob released and flame continuing to remain present in the combustion area, you can now select the flame height you would like for your enjoyment. If you turn the gas valve knob further counterclockwise until it stops, the appliance will be running at the maximum. Turning the valve control knob back (clockwise) until it reaches the Stop Point is the lowest setting. The flame can be modulated by setting the valve control knob anywhere between these two points. It may be necessary to select a higher setting due to windy conditions. This will be evident if the appliance flame is being blown sideways or if it is extinguished due to lack of flame contact with the thermocouple. Extremely windy conditions are not recommended for operation of the appliance, as flames are being blown out of the combustion area and can be very hazardous, causing personal or property damage. Also, if the flame is not allowed to burn properly in the designated combustion area, the thermocouple may not be properly or constantly heated and the appliance will continue to shut off repeatedly.



5. Once you are finished enjoying your appliance, turn the gas valve control knob clockwise until it stops (Stop Point / Lowest Flame Height). Once there, depress the gas valve control knob and continue to turn clockwise until it stops at the Start Point / Off Position and release. All flames should become extinguished. Finally, do not forget to turn off your gas supply for the appliance when you are not using it. This could be turning your propane tank off or locating your natural gas line shut-off and turning it to the closed position.

