



# ZCVRB47/60/72

DIRECT VENT LINEAR GAS FIREPLACE



THE ULTIMATE IN DESIGN, ENGINEERING & QUALITY

ZCVRB60NE Zero Clearance Direct Vent Fireplace (Natural Gas), RBCB1 Cannonballs.



Warm up your favourite room with the beauty of a Linear Fireplace.

## ZCVRB47/60/72

### STANDARD FEATURES

- Hi/Low Millivolt or IPI valve system will operate during power failures
- Decorative Bronze Glass
- Mobile Home, Bedroom and Bed Sitting Room approved
- Safety Screen Barrier

### OPTIONAL FEATURES

#### Surround

Stainless Steel or Black

#### Fan Kit

Heat activated with variable speed control

#### Universal Light Kit

Accent Lighting – Halogen Lamps

#### Wall Mount Thermostat

Standard On/Off or Programmable  
5 day (weekday) and 2 day (weekend)

#### Liner

Porcelain Reflective

#### Media Options

Multi-Colored Cannonballs

#### Remote Control

On/Off, Thermostat On/Off, Thermostat On/Off modulating,  
Thermostat On/Off modulating and fan control

#### \*Enclosure Grill Opening

Model	Front Width	Front Height	Side Width	Side Height
<b>ZCVRB47</b>	46 3/4"	2 5/8"	15 1/4"	6 5/8"
<b>ZCVRB60</b>	60 5/8"	3 5/8"	15 1/4"	6 5/8"
<b>ZCVRB72</b>	78 5/8"	3 5/8"	15 1/4"	9"

\*When appliance is installed using vented chase technology.



IPI OR MV



THE ULTIMATE IN DESIGN, ENGINEERING & QUALITY

**The ultimate in Zero Clearance Direct Vent Fireplaces  
for new home construction or renovation, and your best  
choice for installation anywhere throughout your home.**



ZCVRB72NE Zero Clearance Direct Vent Fireplace (Natural Gas), ZCVRB72PL Porcelain Reflective Liner.  
(Shown as a Vented Chase – VL72EGS Front Enclosure Grill)



# ZCVRB47

DIRECT VENT LINEAR GAS FIREPLACE



THE ULTIMATE IN DESIGN, ENGINEERING & QUALITY

**ZCVRB47**  
PRODUCT SPECS

**ADDITIONAL ZCVRB47**  
FIREPLACE STYLES

<b>Model</b>	ZCVRB47N ZCVRB47NE	ZCVRB47LP ZCVRB47LPE
<b>Fuel</b>	Natural	Propane
<b>Gas Control</b>	Millivolt / IPI	Millivolt / IPI
<b>Input Max.</b>	24,500 BTU	24,500 BTU
<b>Input Min.</b>	16,500 BTU	20,500 BTU
<b>FE (P.4.1-15)</b>	55.26% / 57.31%	55.01% / 57.10%
<b>Glass Size</b>	40 5/8" x 13 7/8"	40 5/8" x 13 7/8"
<b>Venting</b>	4"/7" Flex or 4" x 6 5/8" Hard Pipe	4"/7" Flex or 4" x 6 5/8" Hard Pipe

**FIREPLACE DIMENSIONS**

**ZCVRB47N**

Width	Height	Depth
46 5/8"	38 5/8"	17 3/4"

**FRAMING DIMENSIONS**

**ZCVRB47**

Width	Height	Depth
47"	38 3/4"	18 1/4"*

\*dependent of finishing material used.



ZCVRB47NE Zero Clearance Direct Vent Fireplace (Natural Gas), ZCVRB47PL Porcelain Liners.



ZCVRB47NE Zero Clearance Direct Vent Fireplace (Natural Gas), RBCB1 Cannonballs x14, ZCVRB47PL Porcelain Liners.



ZCVRB47NE Zero Clearance Direct Vent Fireplace (Natural Gas), ZCVRB47PL Porcelain Reflective Liner. (Shown as a Vented Chase – V46EG Front Enclosure Grill)



# ZCVRB60

DIRECT VENT LINEAR GAS FIREPLACE



THE ULTIMATE IN DESIGN, ENGINEERING & QUALITY

**ZCVRB60**  
PRODUCT SPECS

**ADDITIONAL ZCVRB60**  
FIREPLACE STYLES

<b>Model</b>	ZCVRB60N ZCVRB60NE	ZCVRB60LP ZCVRB60LPE
<b>Fuel</b>	Natural	Propane
<b>Gas Control</b>	Millivolt / IPI	Millivolt / IPI
<b>Input Max.</b>	35,000 BTU	35,000 BTU
<b>Input Min.</b>	23,000 BTU	28,000 BTU
<b>FE (P.4.1-15)</b>	55.27% / 56.66%	55.27% / 56.66%
<b>Glass Size</b>	60" x 17 7/8"	60" x 17 7/8"
<b>Venting</b>	5" / 8"	5" / 8"

**FIREPLACE DIMENSIONS**

**ZCVRB60N**

Width	Height	Depth
66 3/16"	39 9/16"	19 1/4"

**FRAMING DIMENSIONS**

**ZCVRB60**

Width	Height	Depth
67"	39 3/4"	19 1/4"*

\*dependent of finishing material used.

ZCVRB60N Zero Clearance Direct Vent Fireplace (Natural Gas), ZCVRB60S1BL Surround (Black), ZCVRB60PL Porcelain Liners.



ZCVRB60NE Zero Clearance Direct Vent Fireplace (Natural Gas), ZCVRB60S1SS Surround (Stainless Steel), RBCB1 Cannonballs x14, ZCVRB60PL Porcelain Liners. (Shown with V60EG Enclosure Grill Installation)





# ZCVRB72

DIRECT VENT LINEAR GAS FIREPLACE



ZCVRB72NE Zero Clearance Direct Vent Fireplace (Natural Gas),  
RBCB1 Cannonballs x14, ZCVRB72PL Porcelain Liners.



THE ULTIMATE IN DESIGN, ENGINEERING & QUALITY



**ZCVRB72**  
PRODUCT SPECS

**ADDITIONAL ZCVRB72**  
FIREPLACE STYLES

<b>Model</b>	ZCVRB72N ZCVRB72NE	ZCVRB72LP ZCVRB72LPE
<b>Fuel</b>	Natural	Propane
<b>Gas Control</b>	Millivolt / IPI	Millivolt / IPI
<b>Input Max.</b>	50,000 BTU	50,000 BTU
<b>Input Min.</b>	34,000 BTU	39,000 BTU
<b>FE (P.4.1-15)</b>	53.14% / 53.64%	53.14% / 53.64%
<b>Glass Size</b>	73 1/2"W x 17 7/8"H	73 1/2"W x 17 7/8"H
<b>Venting</b>	5" / 8"	5" / 8"

**FIREPLACE DIMENSIONS**

**ZCVRB72N**

Width	Height	Depth
78 3/4"	40 5/16"	19 3/8"

**FRAMING DIMENSIONS**

**ZCVRB72**

Width	Height	Depth
79 1/8"	42"	19"*

\*dependent of finishing material used.



ZCVRB72NE Zero Clearance Direct Vent Fireplace (Natural Gas), ZCVRB60S1B Surround (Black), ZCVRB72PL Porcelain Liners.



ZCVRB72NE Zero Clearance Direct Vent Fireplace (Natural Gas), ZCVRB72S1SS Surround (Stainless Steel), RCB1 Cannonballs x14, ZCVRB72PL Porcelain Liners.

## ACCESSORY OPTIONS

### MEDIA OPTIONS



Decorative Ember Glass – Bronze



Multi-Coloured Cannonballs

### LINERS



Porcelain Reflective Liner

### SURROUNDS

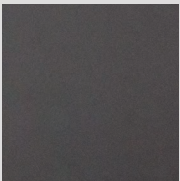

Black

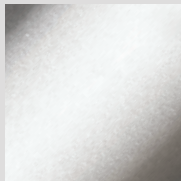

Stainless

## PRODUCT SPECIFICATIONS

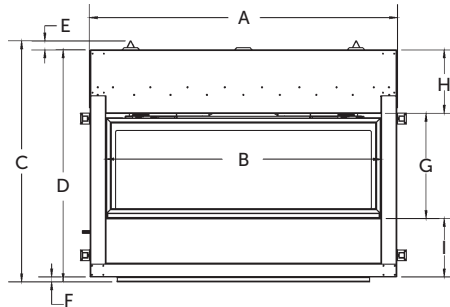

ZCVRB47	ZCVRB60	ZCVRB72
A 46 5/8"	A 66 3/16"	A 78 3/4"
B 41 5/8"	B 61 1/8"	B 73 7/8"
C 38 5/8"	C 39 9/16"	C 42"
D 35 11/16"	D 38 5/16"	D 40"
E 2 1/4"	E 1/2"	E 1 1/2"
F 3/4"	F 3/4"	F 3/4"
G 15 7/8"	G 19 15/16"	G 20"
H 11"	H 9 9/16"	H 11 15/16"
I 8 13/16"	I 8 13/16"	I 7 1/4"
J 34 5/8"	J 53 3/8"	J 71 3/4"
K 17 3/4"	K 19 3/8"	K 19 3/8"
L 11 1/16"	L 11 9/16"	L 12 1/4"
M 29 1/16"	M 33 1/16"	M 34 1/8"
N 31 11/16"	N 35 3/4"	N 40 5/16"
O 17 3/4"	O 18 3/4"	O 19 3/8"
P 2 11/16"	P 2 11/16"	P 4 3/4"
Q 3 3/16"	Q 3 3/16"	Q 3 3/16"

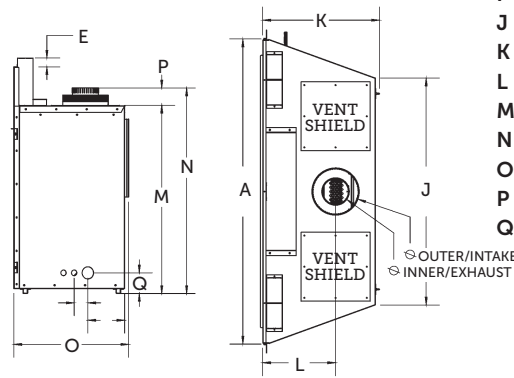

### OPTIONAL SURROUND

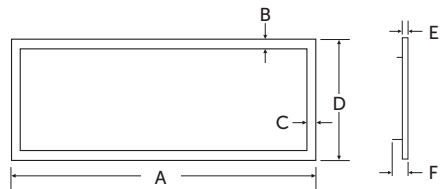

ZCVRB47	ZCVRB60	ZCVRB72
A 44 5/8"	A 64"	A 76 3/4"
B 1 1/5"	B 1 1/2"	B 1 1/2"
C 1 1/2"	C 1 1/2"	C 1 1/2"
D 17 3/4"	D 23"	D 23"
E 1"	E 3/4"	E 3/4"
F 1 3/4"	F 1 3/4"	F 1 3/4"

### OPTIONAL FRONT ENCLOSURE GRILL V46EG/VL60EG/VL72EG

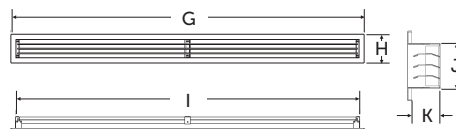

G 47 13/16"	G 61 3/4"	G 79 3/4"
H 3 13/16"	H 4 7/8"	H 4 7/8"
I 46 9/16"	I 60 1/2"	I 78 1/2"
J 2 1/2"	J 3 1/2"	J 3 1/2"
K 1 9/16"	K 1 9/16"	K 1 9/16"
L 16 3/16"	L 16 3/16"	L 16 3/16"
M 7 7/8"	M 7 7/8"	M 10 3/8"
N 6 7/16"	N 6 7/16"	N 8 15/16"
O 1/4"	O 1/4"	O 1/4"
P 15 7/16"	P 15 7/16"	P 15 7/16"
Q 2 9/16"	Q 2 9/16"	Q 2 9/16"

### OPTIONAL SIDE GRILL – VL60EGS/VL72EGS

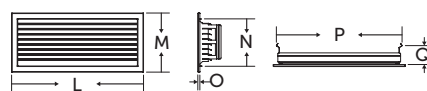

## VENTED CHASE OPTIONS

The chase of the appliance may be vented to achieve Cool Touch Walls or reduced Mantel Clearances. The following options are available to vent the chase:

- The top of the chase can be left open.
- A grill can be installed on the front of the chase.
- If the chase bumps out into the room, side grills can be installed on each side of the chase.

Minimum enclosure height for a vented chase is measured from bottom of fireplace, ventilation of minimum free air opening is required. Choose between our Enclosure Grills (Front or Sides) or Custom Grill (if custom grills are used the louvers cannot slope) or adequate ventilation opening as stated in the manual. Grill or opening must meet minimum (as specified in the installation manual) of chase top/ceiling.

Framing to ceiling with open front

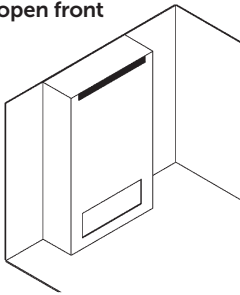

Open chase framing with enclosure min below ceiling

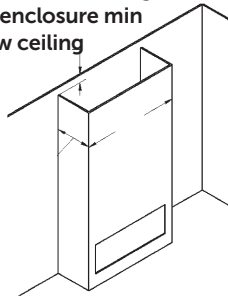

Framing to ceiling with vents at front and back

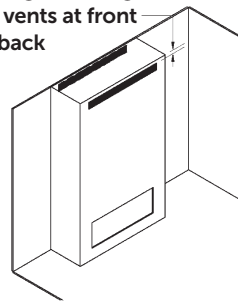

Minimum enclosure with front and back vents

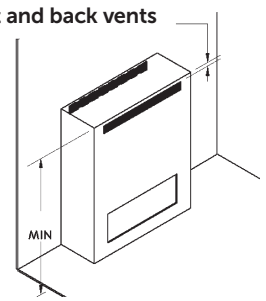

Framing to ceiling with front or side vents

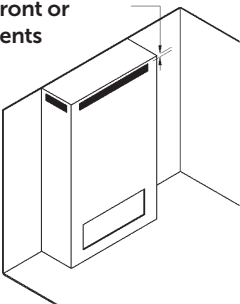

Framing to ceiling, minimum enclosure with front or side vents

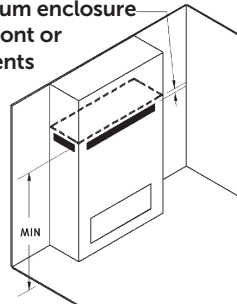

Minimum enclosure with front or side vents

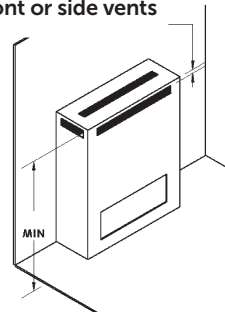

*NOTE: To vent the fireplace chase, removal of vent shields from the fireplace is required.*

### SPECIFICATIONS

#### WITH OPENINGS

##### (MIN. NO GRILLS)

Min. Enclosure Height	70"	76"	79"
Min. Opening Below Ceiling	1-1/4"	1-7/8"	2-3/8"

#### WITH GRILLS

##### (MIN. AIR FREE OPENINGS)

Min. Enclosure Height	70"	76"	79"
Grill Opening (Max. Distance from top of Ceiling)	2"	3/4"	3/4"

#### ZCVRB47

#### ZCVRB60

#### ZCVRB72

105 sq/in.

200 sq/in.

285 sq/in.

70"

76"

79"

1-1/4"

1-7/8"

2-3/8"

105 sq/in.

220 sq/in.

285 sq/in.

70"

76"

79"

2"

3/4"

3/4"



Find all detailed ZCVRB47/60/72 manuals.

2340 Logan Avenue  
Winnipeg, Manitoba, Canada R2R 2V3  
Phone: (204) 632-1962 Fax: (204) 632-1960  
[www.kingsmanfireplaces.com](http://www.kingsmanfireplaces.com)

ZCVRB47N Zero Clearance Direct Vent Gas Fireplace (Natural Gas), ZCVRB47S1SS Surround (Stainless Steel), ZCVRB47PL Porcelain Liners. (Shown with Vented Chase Installation – top of chase left open)



\*Components may have to be ordered separately to create a complete unit. Discuss with your local Kingsman dealer for clarification. Kingsman Fireplaces maintains a program of continuous testing, refinement and improvements of all its products. Some aspect of units shown here may be changed at any time without notice or obligation.



CRAFTED ENTIRELY IN CANADA, EACH KINGSMAN FIREPLACE IS BUILT TO THE HIGHEST STANDARDS AND MADE TO LAST.



**FOR CALIFORNIA RESIDENTS ONLY:**

**WARNING!** This product can expose you to chemicals including Carbon Monoxide, that is an externally vented by-product of fuel consumption, which is [are] known to the State of California to cause birth defects or other reproductive harm. For more information, visit [www.P65Warnings.ca.gov](http://www.P65Warnings.ca.gov).

Canada

**ENERGUIDE**

Look for the **EnerGuide** Gas Fireplace Energy Efficiency Rating in this brochure

Based on CSA P.4.1-15