



**delego**  
does it for you



# CONCEPT



## The etymology of the word **Delégo**

delegate v. tr. [from lat. delegare, comp. of de- and legare “to send with some task”,  
der. from lex legis “law”] (I delegate, you delegate, etc.).

1. To instruct someone to perform some act on one’s behalf.
2. Entrusting others with the exercise of one’s own functions or powers.

## All in one touch

With just a single gesture, the curtain opens on a world of solutions, experiences and scenarios. It is time to start new daily rituals.

**Wherever you are, whenever you want,  
Delégo does it for you.**



## High quality of living

At the heart of it all is the person, who can enjoy multiple functions in a total experiential immersion. Living without limits, allowing yourself the luxury of your time, managing and controlling all spaces with a simple tap, choosing sustainability.

## Experience

Experiencing your own space has never been so simple, immediate and engaging.

## Control

Complete management and control of all environments in which you live and work.

## Comfort

Because wherever you are, at all times, Delégo does it for you.

## Security

The core value of Delégo.



## Design, Technology and Made in Italy

A precise and conscious choice: Ekinex offers innovative and complete solutions for living spaces. And it is the meticulous attention to every detail that creates perfect objects, for their stylish balance and for what they are capable of doing. And 100% Made in Italy makes the difference.





## Family feeling

Products designed and created following a strictly harmonious stylistic line, focusing on the smallest details, to ensure that the interaction with the environment is beautiful, clean, essential.





## **Intuitive, Immediate, Simple. Beautiful**

The secret of Ekinex: thinking of useful (or rather very useful) solutions for the quality of living, choosing attractive designs, and enhancing them with materials and finishes that embellish and interact with the surroundings. Whatever their style is.



# THE SYSTEM

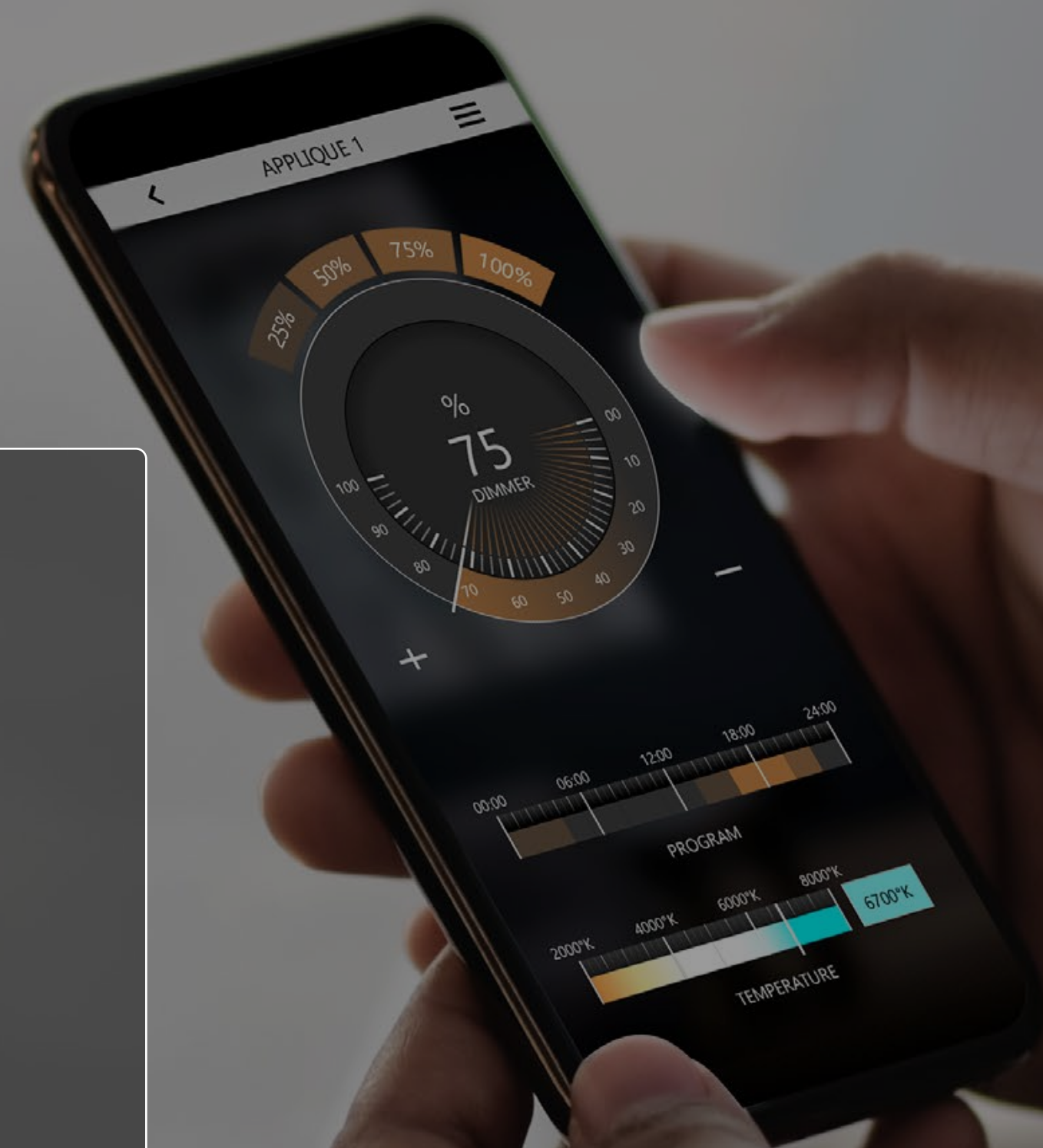

## Multisystem Multiuser

Several users (e.g. those belonging to the same household), having appropriate credentials, can interact with systems associated with different sites or with only some of them.

Each individual user can also be given the option of managing all or only some of the system's functions (functions accessible by entering additional credentials).

In the example shown, user 1(●) will be able to interact with the systems of all properties without any restrictions. User 3(●) will only be able to access systems 1(●) and 3(●) (the latter with additional restrictions).

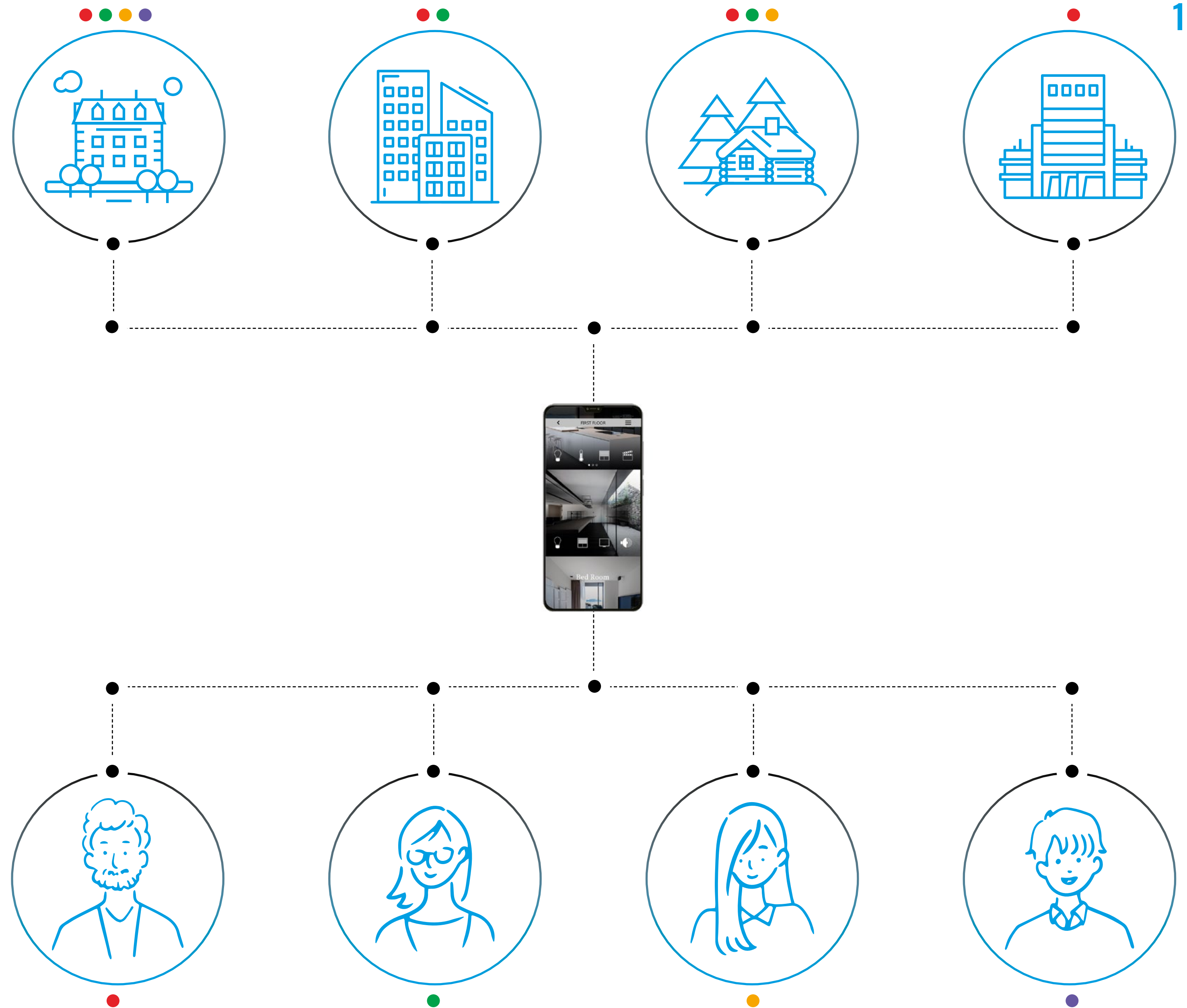

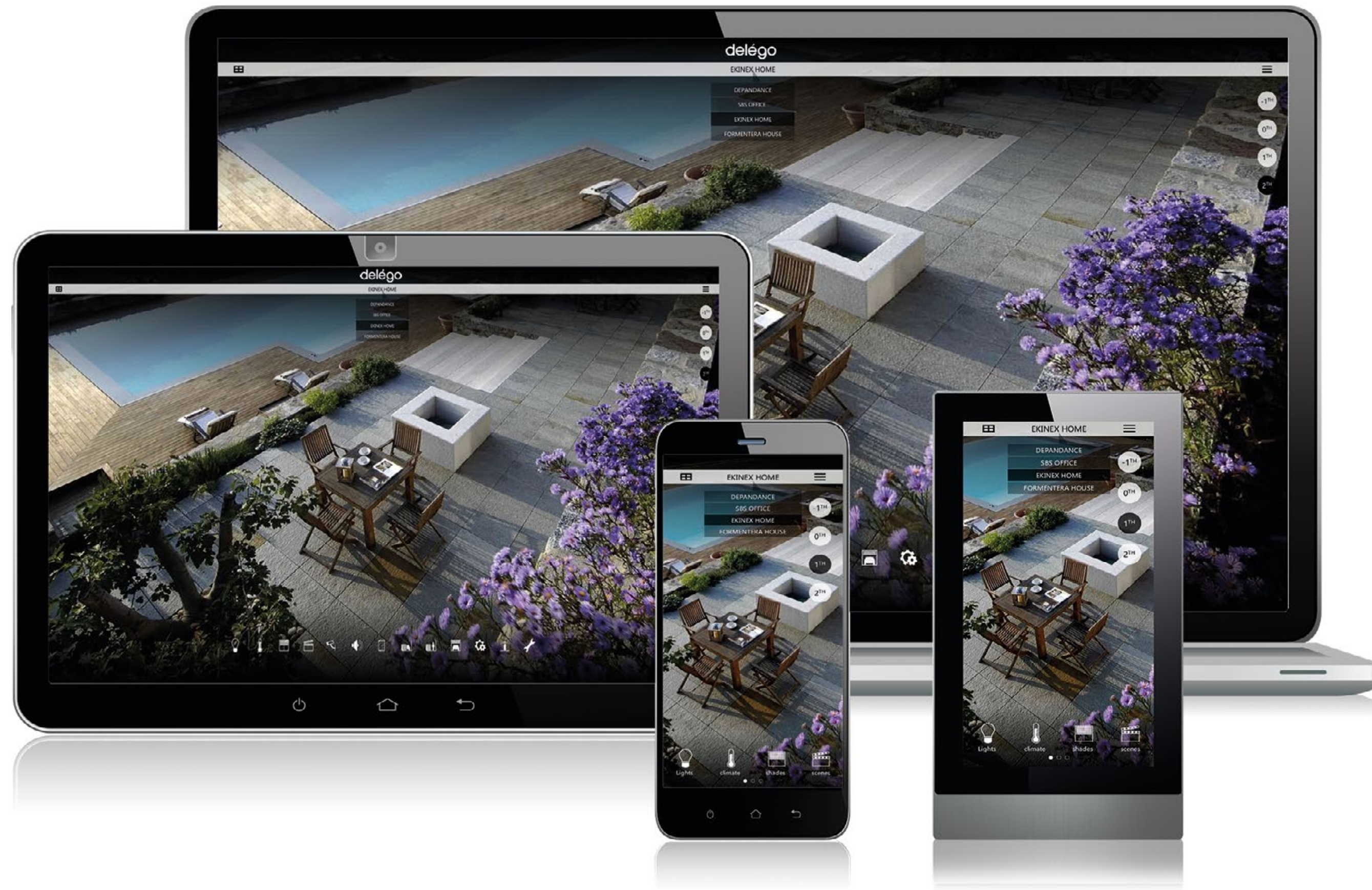

## Interaction through different devices

In an increasingly connected world with demanding lifestyles, what we ask of technology is to help us live well. The Delégo supervisor is designed to adapt to any style and needs and to offer the best user experience on any device: desktop PC, tablet or smartphone.



## Configuration and maintenance simplified

Thanks to the web interface, the system can be programmed online and offline (without a Delégo server connected), and thanks to the import tool for ETS project files, all group addresses used can be quickly integrated.

The system also supports incremental system upgrades via further imports. The graphics of the widgets are automatically adapted according to the KNX communication objects connected in the project.

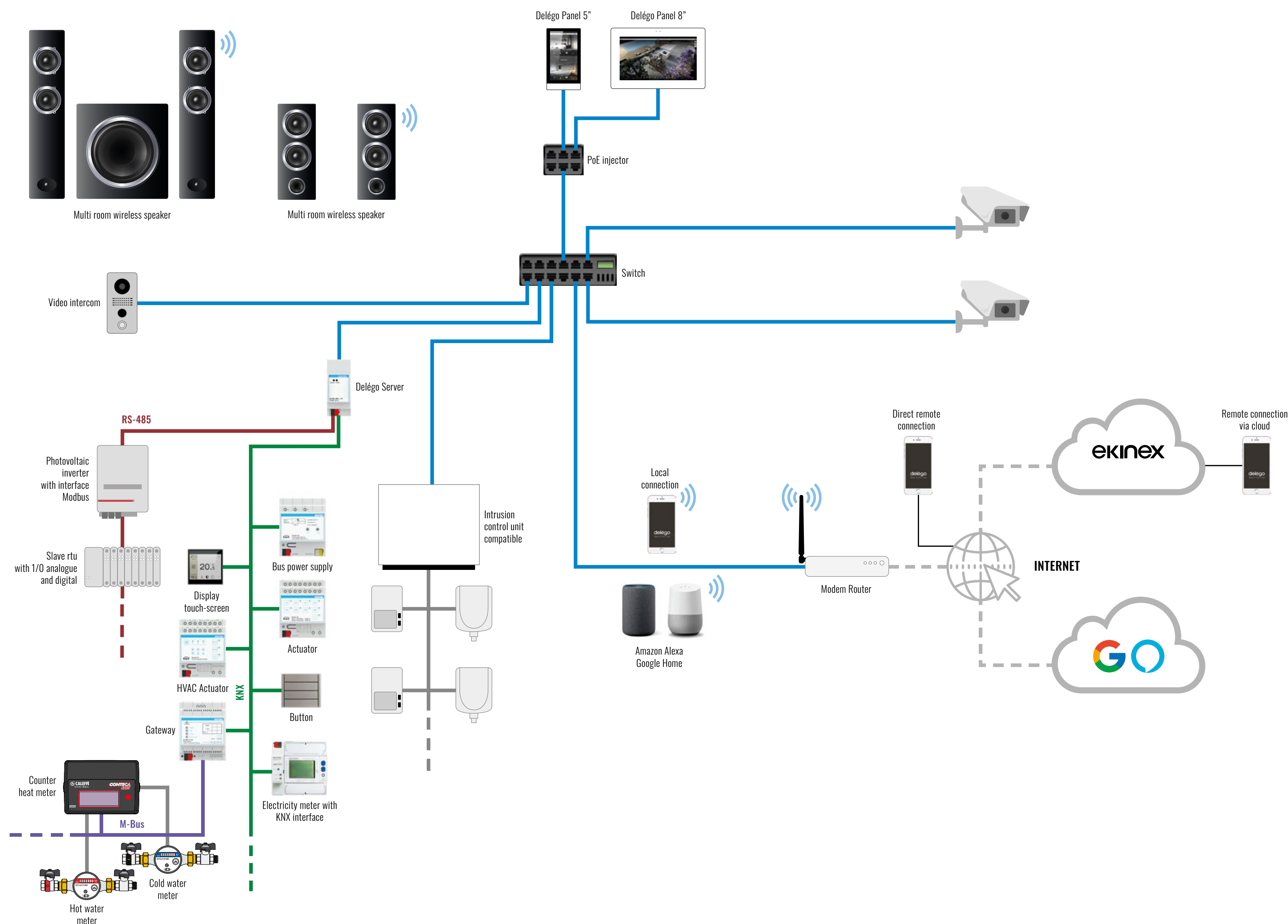

## System structure

The delégo server connects directly to the KNX system and the building's LAN network, through which it can be managed both locally and remotely, via a mobile app or web browser.

Through the LAN network it is possible to interact with devices that do not operate directly on KNX standards, as long as they are compatible with the communication protocols integrated in the server.

Third-party integrations include:

- Devices with Modbus protocol
- SONOS zone multimedia systems
- Video surveillance
- IP video door entry systems
- Burglar alarm

## Security, local and remote management

The Delégo app and the server installed in the building network, exchange information for monitoring and controlling the automation system via the public Internet.

Communication between clients accessing Delégo and the server takes place safely via an encrypted connection in accordance with the latest security standards.

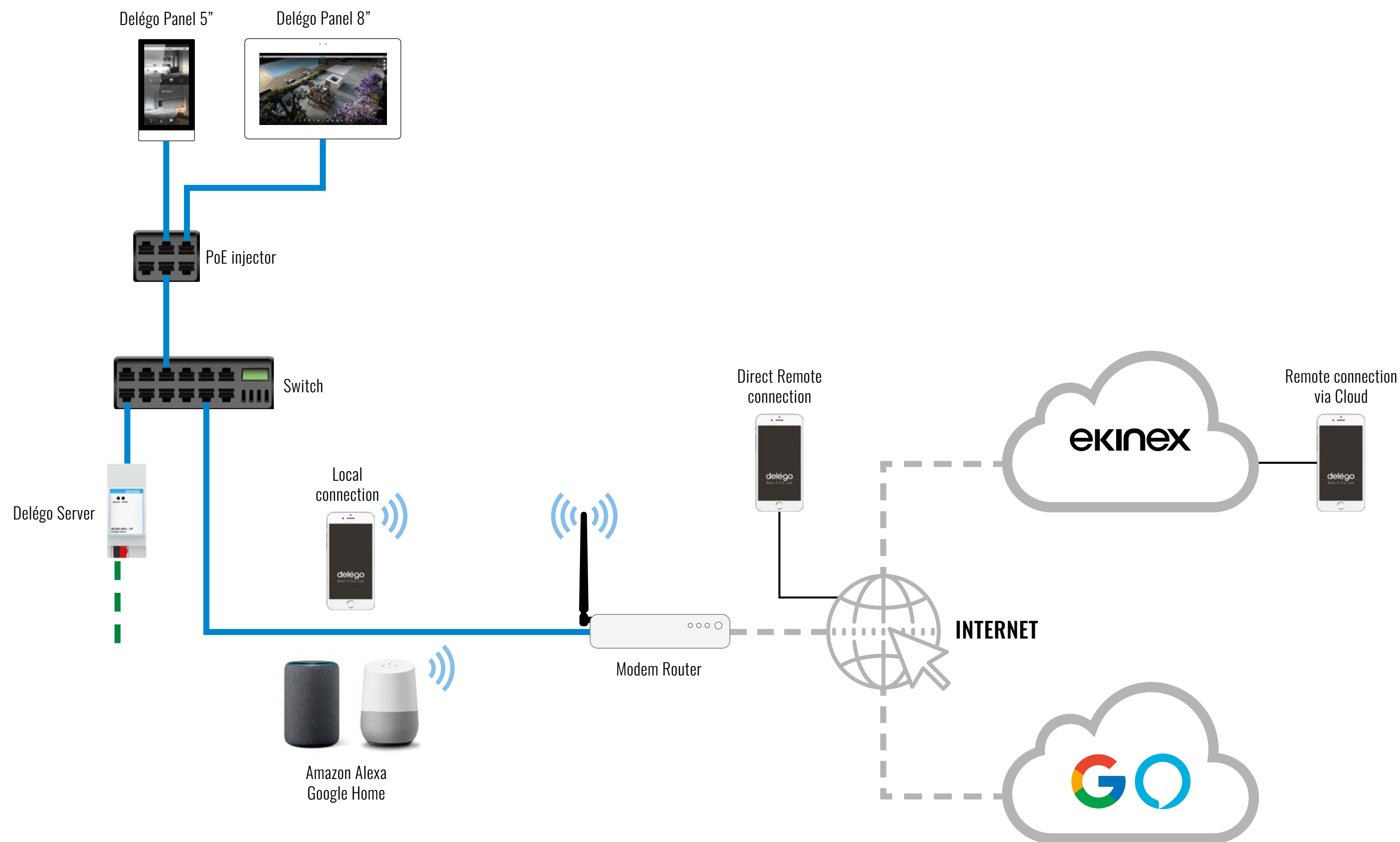





# FUNCTIONS

## Many functions, only one solution

Click on the functions to find out more

Managing lighting, controlling the climate, creating a scenario, monitoring security and consumption - these are just some of the functions managed by Delégo.



## Customise your experience with Delégo

Click on the widgets to find out more

Widgets to help you live your SmartHome, while leaving more time to yourselves.

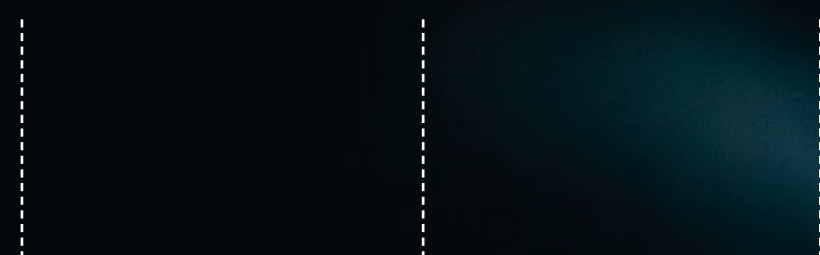

## Voice control with Alexa and Google Assistant

Delégo in combination with the Ekinex cloud service enables interaction with the home automation system through voice commands given to Amazon and Google smart speakers.

- Alexa, switch on the light in the kitchen
- Alexa, set the light in the living room to 70%
- Alexa, increase the light in the bedroom by 20%
- Ok Google, tell me the temperature in the living room
- Ok Google, set the temperature in the kitchen to 21 degrees
- Ok Google, execute turn everything off



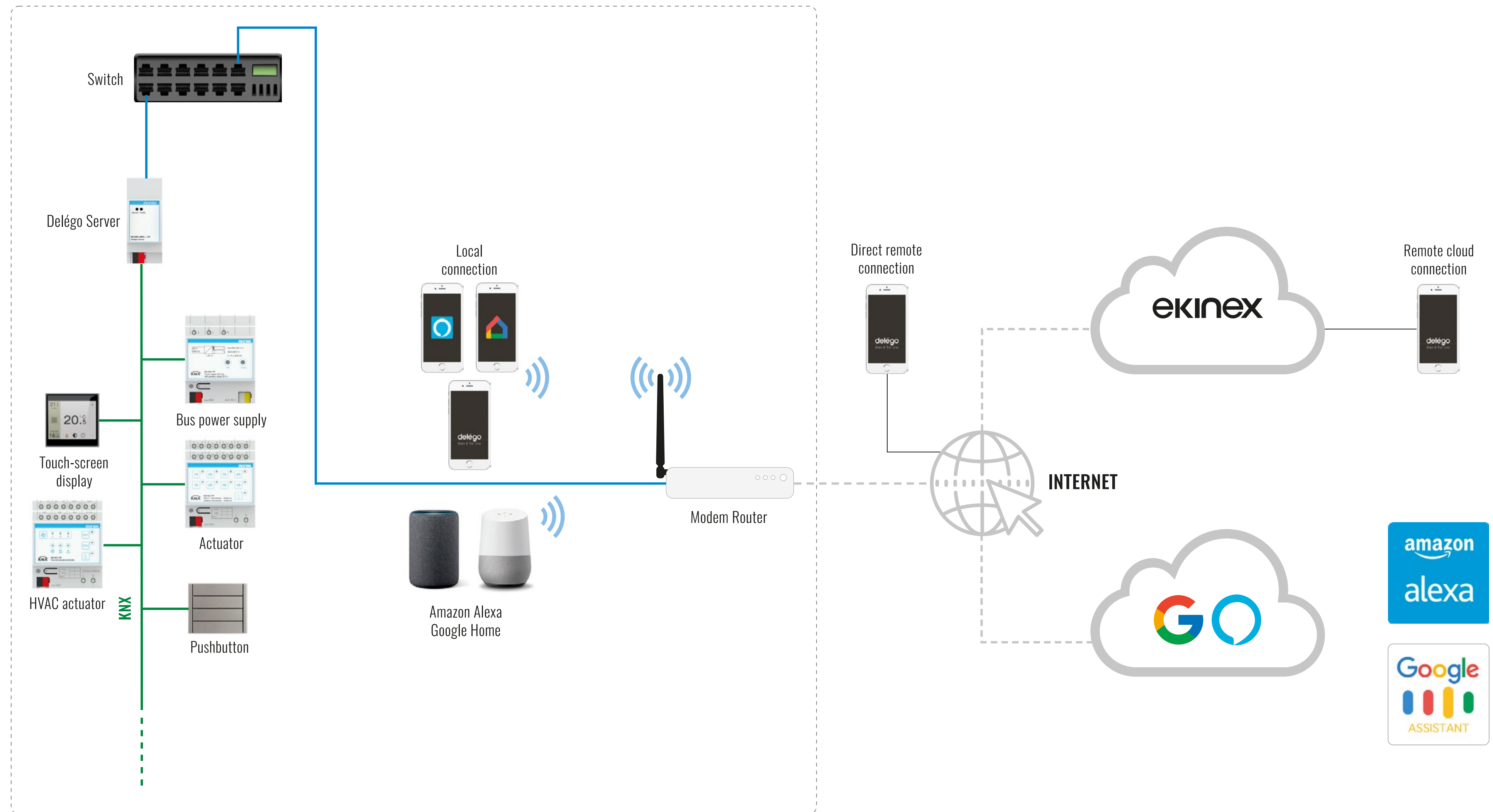



# OVERVIEW

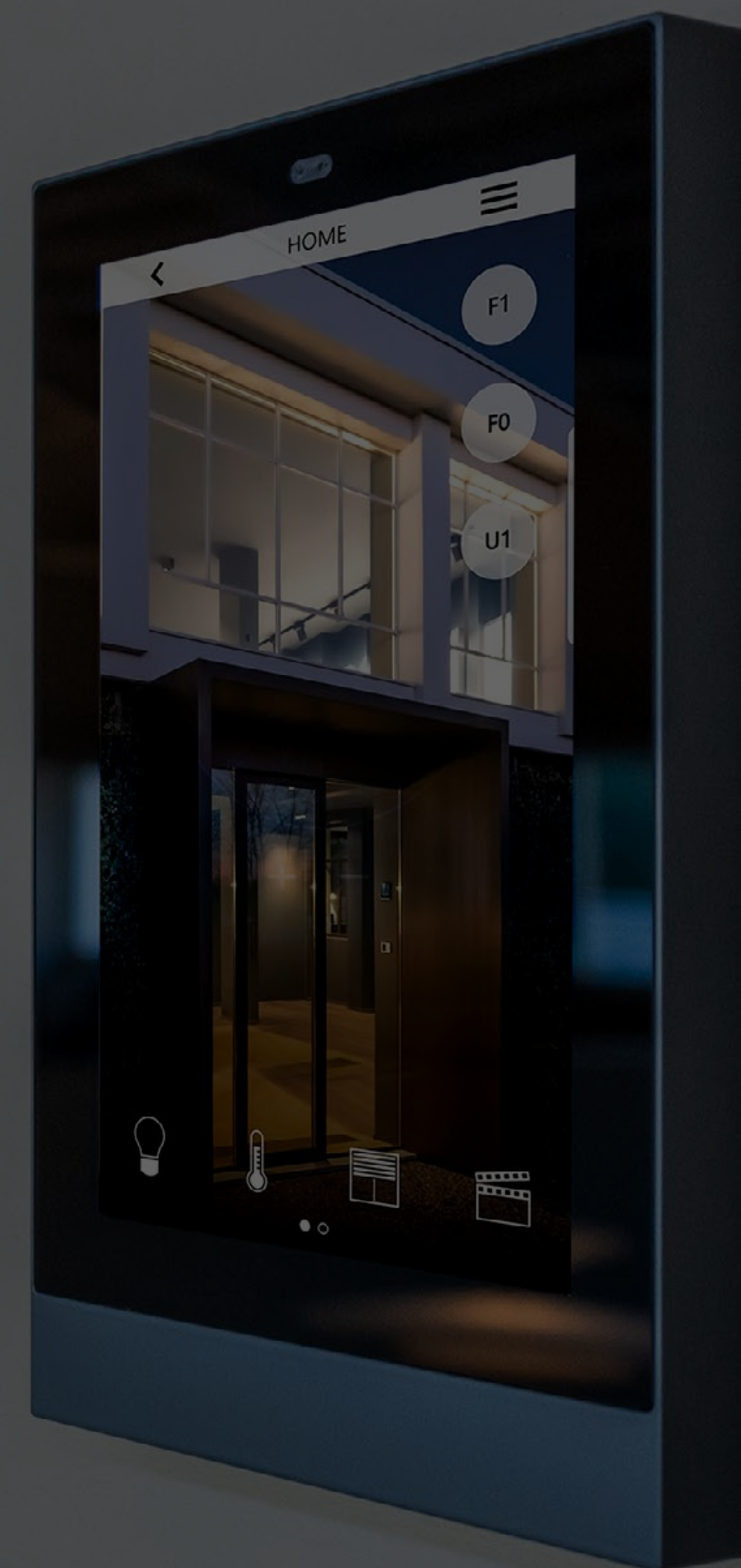



## Delégo panel

Range of full-colour touch-screen panels for on-wall recessed installation, with IP connection. Ideal for creating permanent supervision stations and for the integration of multimedia systems. The series includes panels with 5" and 8" capacitive displays with an internal frame in black and glossy white; aluminium frame available for the 5" version.

- **Delégo App:** Pre-installed
- **Intercom App for VoIP:** Pre-installed
- **Power:** Power Over Ethernet (PoE)
- **Connectivity:** LAN 100baseT
- **Type:** 5" HD IPS LCD, 8" HD IPS LCD
- **Colours:** 16.7 million colours (true colour)
- **Resolution:** 1280 x 720
- **Touch screen:** capacitive with multi-touch & gesture support
- **Speakers:** high definition audio with built-in amplifier, 2W
- **Microphone:** integrated high-resolution microphone with echo cancellation
- **Operating system:** Android
- **Certifications:** CE / FCC class B / FCC part 15 / RoHS / WEEE



## Delégo panel 5"

Code:

**EK-DEL-5PAN**

**EK-DEL-5PANWH**

### Main features

- External dimensions: 132 x 81 x 14 mm (W x H x D)
- Display size: 104 x 58 mm (W x H)
- Orientation: portrait
- Plastic internal frame: black or glossy white
- Aluminium frame: optional
- 5" model compatible back box:
  - 2M recessed box (e.g. bTicino mod. 502E);
  - 60 mm diameter round box (e.g. Gewiss mod. 24232);
  - 3M recessed box (e.g. bTicino mod. 503E)

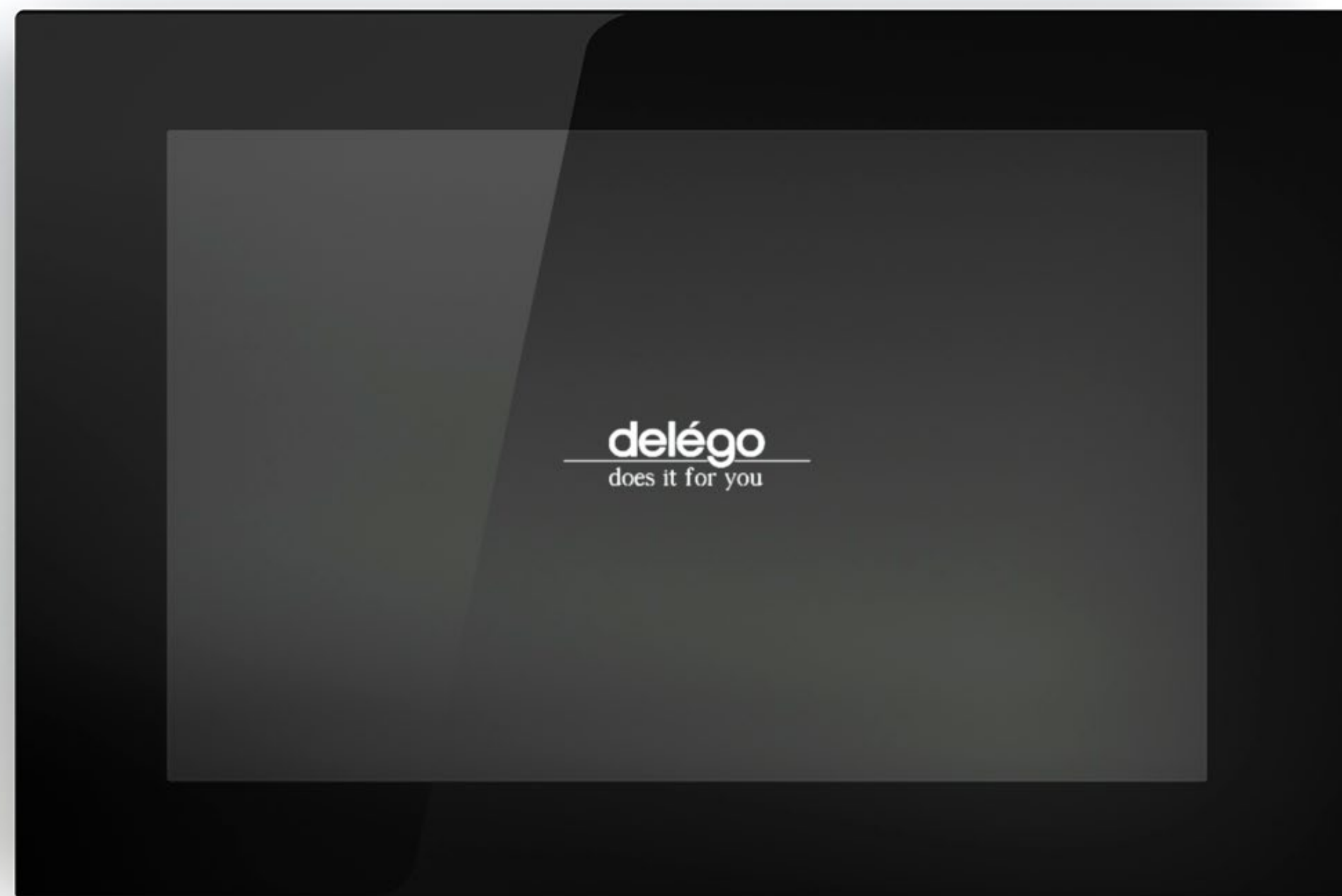

## Delégo panel 8"

Code:

**EK-DEL-8PAN**

**EK-DEL-8PANWH**

### Main features

- External dimensions: 224 x 149 x 16 mm (W x H x D)
- Display size: 183 x 103 mm (W x H)
- Orientation: landscape
- Plastic frame: black or glossy white
- Flush-mounted box compatible with 8" model: e.g. bTicino mod. 16204

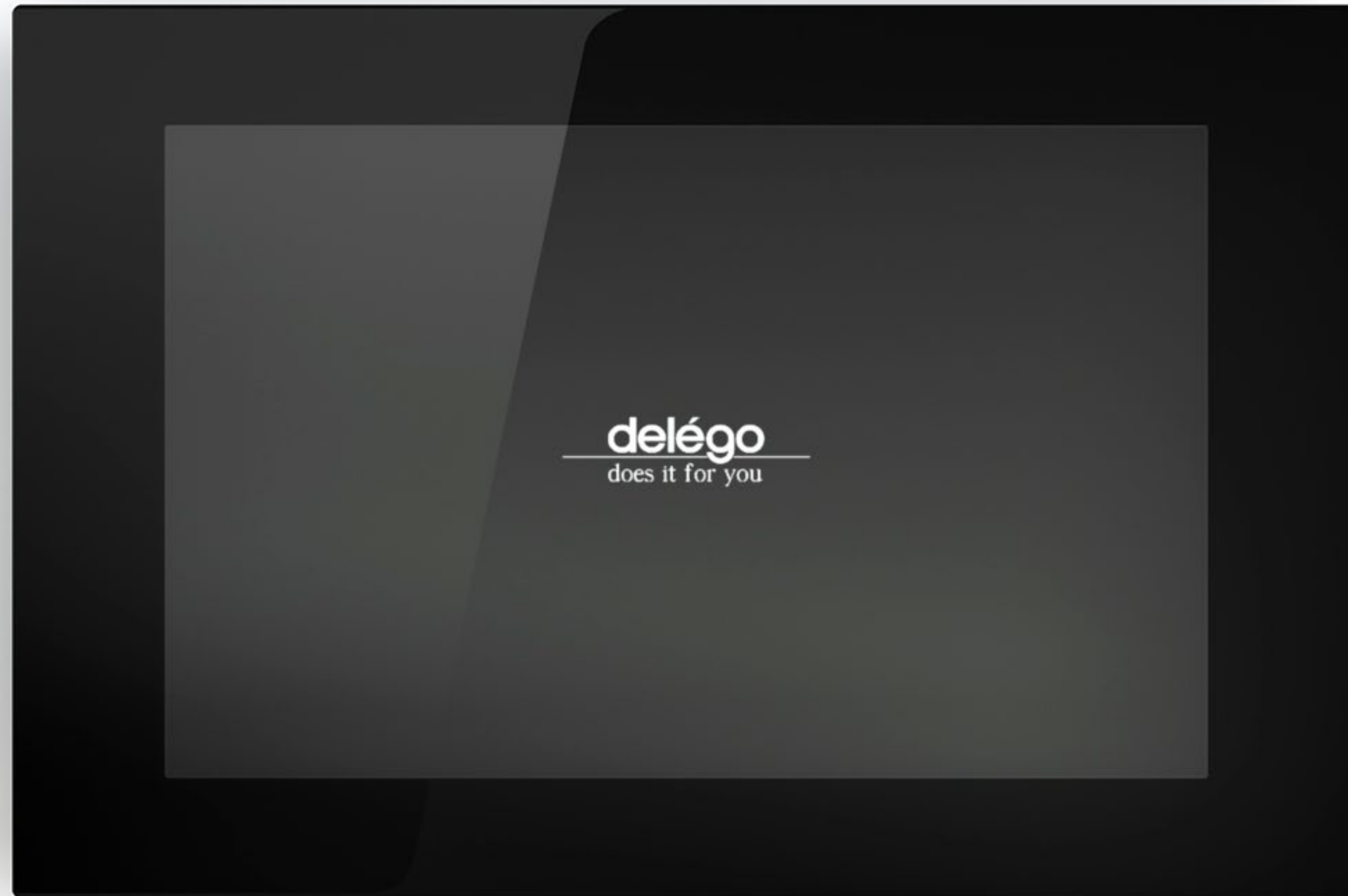

## Delégo panel 11"

Code:

**EK-DEL-11PAN**

**EK-DEL-11PANWH**

### Main features

- External dimensions: 224 x 149 x 16 mm (W x H x D)
- Display size: 183 x 103 mm (W x H)
- Orientation: landscape
- Plastic frame: black or glossy white
- Recessed box compatible with 11" model: e.g. bTicino mod. 16204



## Delégo server

Delégo server is the web supervision system for KNX-based installations. It allows you to manage all the functions in the property using any type of device (PC/MAC, touch-PC, smartphone, tablet), as long as it has a web browser, either locally or remotely via the Internet. The graphics are customisable, suitable for any context and application and ideal for viewing on different static and mobile platforms.

Code: **EK-DEL-SRV-...-TP**

- Local connection of mobile devices via WiFi network.
- Remote connection of mobile devices via direct connection of the terminal server to the internet (with port forwarding) or via connection to the Ekinex cloud. device's direct connection to the Internet (with port forwarding) or via connection to the Ekinex cloud.
- Secure connection via TLS/SSL encryption.
- Integration with Amazon's Alexa and Google Assistant voice assistants.
- Integrated web server for logical and graphical system visualisation.
- Integrated web server for system configuration: automatic ETS project import, room configuration ETS project, room configuration, logic processing functions combinatorial functions, timings, etc. (combinatorial functions, timings, mathematics, astronomical clock, etc.).



### Main features

- Dimensions 90.5 x 62 x 36 mm - 2 DIN modules
- Power supply 12 - 24 VDC
- Plug-in terminal supplied
- Power consumption 240 mA at 24V
- LAN connections (RJ45)
- KNX (red-black terminal) - RS485 (terminal supplied)
- USB - LED Power - Service / Reset
- Degree of protection IP 20 (according to EN 60529)
- Insulation class II (in accordance with EN 60335-1)
- Operating temperature +0°C ... +40°C
- Storage temperature -10°C ... +70°C

## Licenses and vouchers

The Delégo supervision system is available in 3 licence levels. Each licence level allows you to manage a different number of KNX group addresses, according to the summary table below.

LICENSE	CODE	KNX GROUP ADDRESSES	AREAS	SCENARIOS	SCHEDULES	LOGICS
BASIC	EK-DEL-SRV-BAS-TP	400 max	100	100	100	100
ADVANCED	EK-DEL-SRV-ADV-TP	1200 max	100	100	100	100
PREMIUM	EK-DEL-SRV-PRM-TP	2500 max	100	100	100	100

**Upgrade licences are available** to extend the number of KNX group addresses of the product (max. 2500 KNX group addresses).

CODE	TIPOLOGY	DESCRIPTION
EK-DEL-UPGR-BA	license	upgrade server Delégo basic-advanced
EK-DEL-UPGR-BP	license	upgrade server Delégo basic-premium
EK-DEL-UPGR-AP	license	upgrade server Delégo advanced-premium

**Additionally, a voucher code is available to extend the functionality of the system (COD. EK-DEL-V1).**

The upgrade codes and the voucher are activated in the configuration environment of the web server under Module and licence management.

ADVANCED FUNCTIONS		INCLUDED IN THE LICENSE	VOUCHER
Control via Amazon and Google voice assistants		X	
Weather service		X	
IFTTT		X	
Modbus	Read/write RS485 RTU and TCP/IP registers	up to 30 registers	more than 30 registers
Load control and energy monitoring		X	
<b>MULTIMEDIA INTEGRATION</b>			
Sonos	Modular WiFi-based multiroom system	X	
<b>MULTIMEDIA INTEGRATION</b>			
Mobotix			X
2N Telecommunications			X
DoorBird			X
CAME	Thangram series		X
Comelit			X
Dahua Technology			X

	ADVANCED FUNCTIONS	INCLUDED IN THE LICENCE	VOUCHER
<b>IP VIDEO DOOR SYSTEM INTEGRATION</b>			
Vimar	41007 series		X
VIDEX			X
InfinitePlay			X
<b>VIDEO SURVEILLANCE INTEGRATION</b>			
Axis		X	
Mobotix		X	
Elvox		X	
HikVision		X	
Dahua Technology		X	
jpg / mjpg / rtsp	Universal holder	X	
<b>ANTI-INTRUSION INTEGRATION</b>			
Tecnoalarm	Tecnoalarm burglar alarm control units compatible with TECNO-OUT protocol with USB and LAN communication		X
EL.MO	VILLEGGIO, ETR and TITANIA series burglar alarm control panels with LAN communication		X
IESS	GENIO series intrusion control panels with LAN communication		X
GEWISS	CHORUS GW10931 burglar alarm control unit with LAN communication		X
Bentel	ABSOLUTA Intrusion Control Panel with LAN communication		X
Paradox	PARADOX EVO range Intrusion Panels with RS232 communication		X

**The Delégo App for mobile devices is available for free**

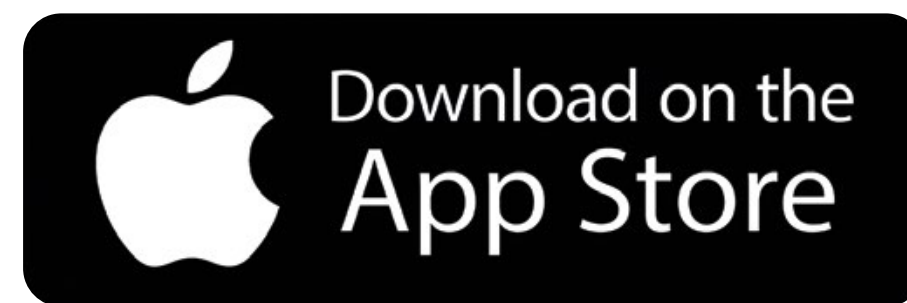



---

# MATERIALS AND FINISHES

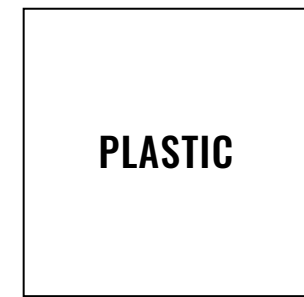

PLASTIC

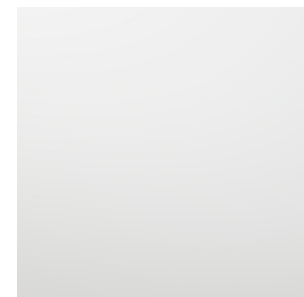

**White**  
GAA



**Intense Black**  
GAE

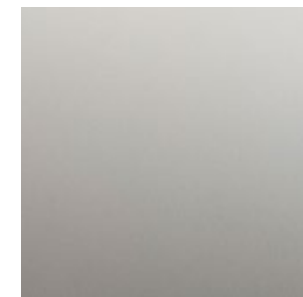

**Silver**  
GAG

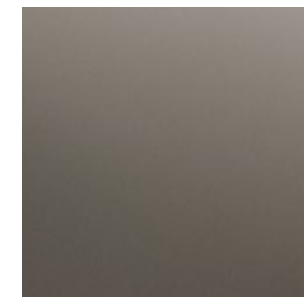

**Hematite**  
GAI

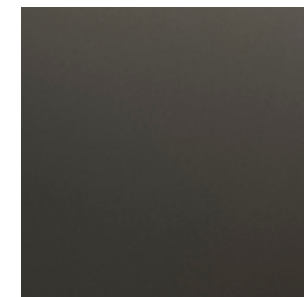

**Graphite**  
GAL

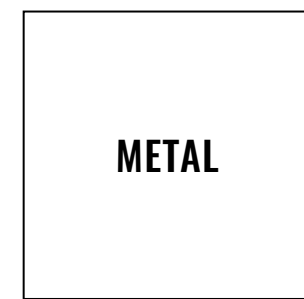

METAL

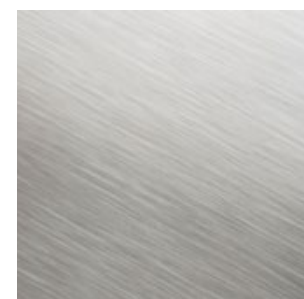

**Aluminum**  
GBQ

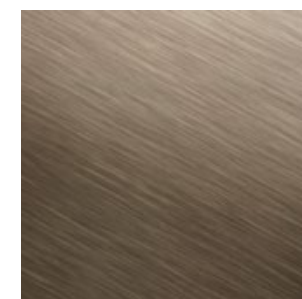

**Nickel**  
GBR

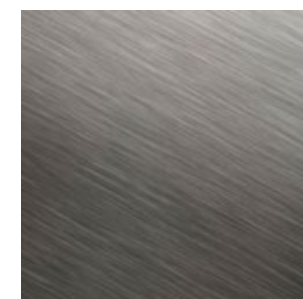

**Titanium**  
GBS



**Carbon**  
GBU

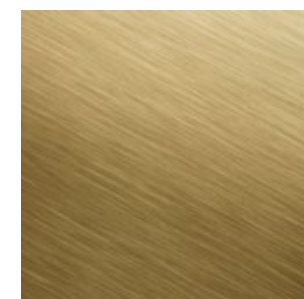

**Brass**  
GBB

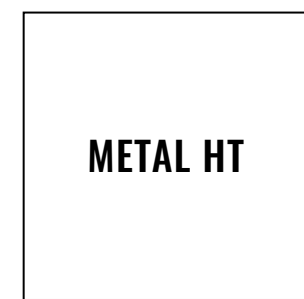

METAL HT

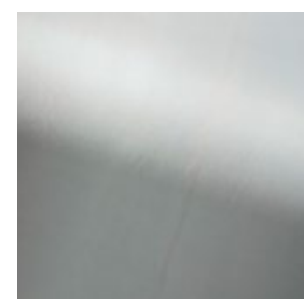

**Chrome**  
CRO

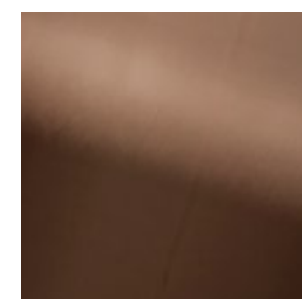

**Copper**  
COP



**Champagne**  
CHA

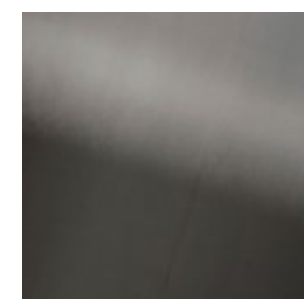

**Black Metal**  
CBM



FENIX <sup>NTM</sup>

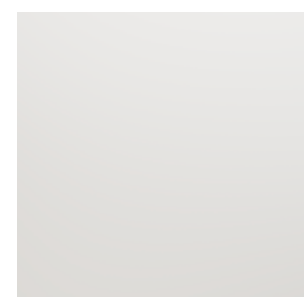

**Malé White**  
FBM



**Beige Luxor**  
FBL



**Beaver Ottawa**  
FCO



**Grey Ephesus**  
FGE



**Grey London**  
FGL



**Grey Bromine**  
FGB

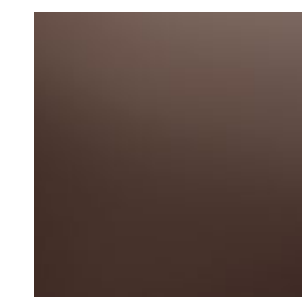

**Cocoa Orinoco**  
FCC



**Green Commodore**  
FVC



**Ingo Black**  
FNI

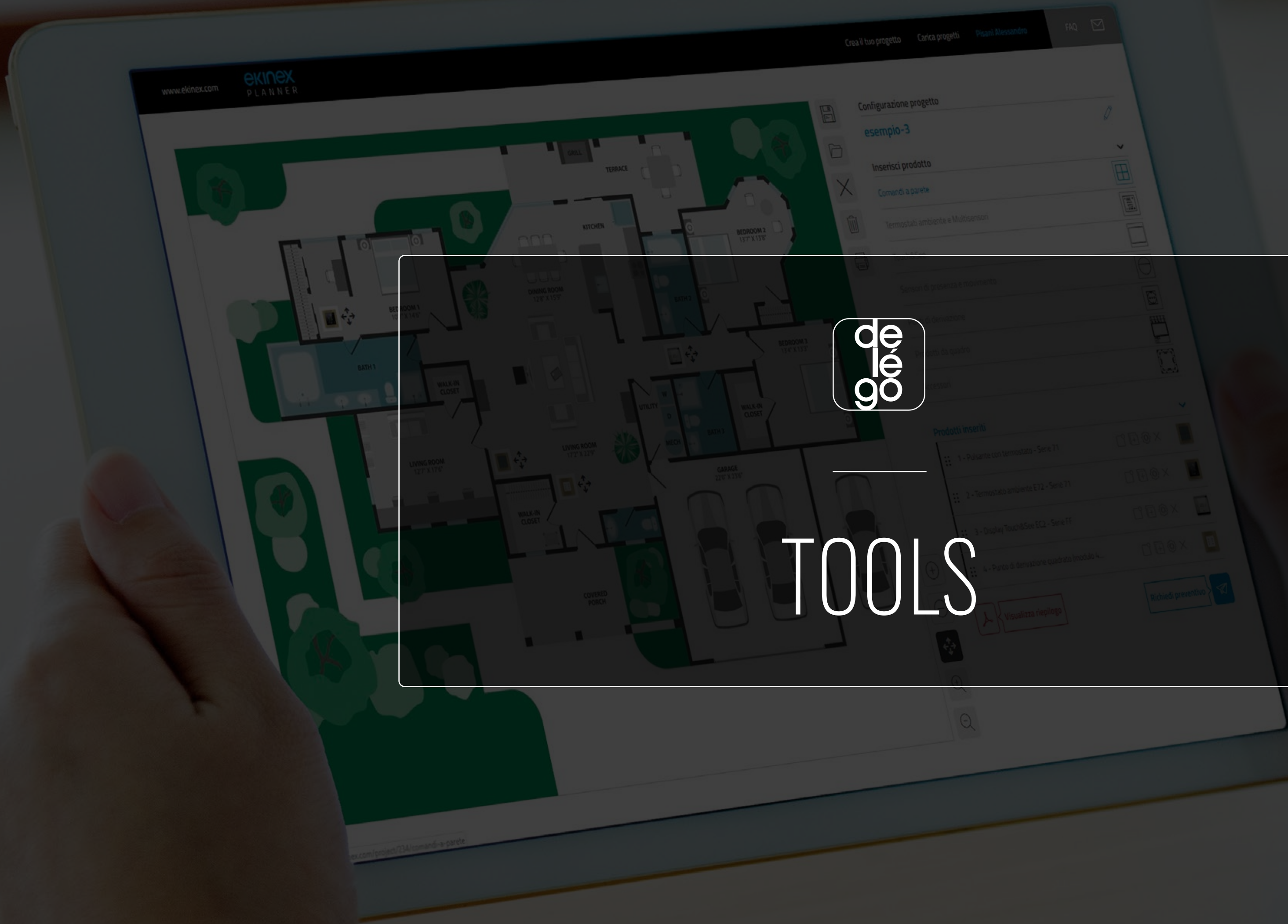

# TOOLS



## Ekinex Planner

Through the Ekinex configurator, each element can be customised and inserted into your project, up to and including the generation of a which is sent to the sales team together with details of the chosen products.

[planner.ekinex.com/en/](http://planner.ekinex.com/en/)

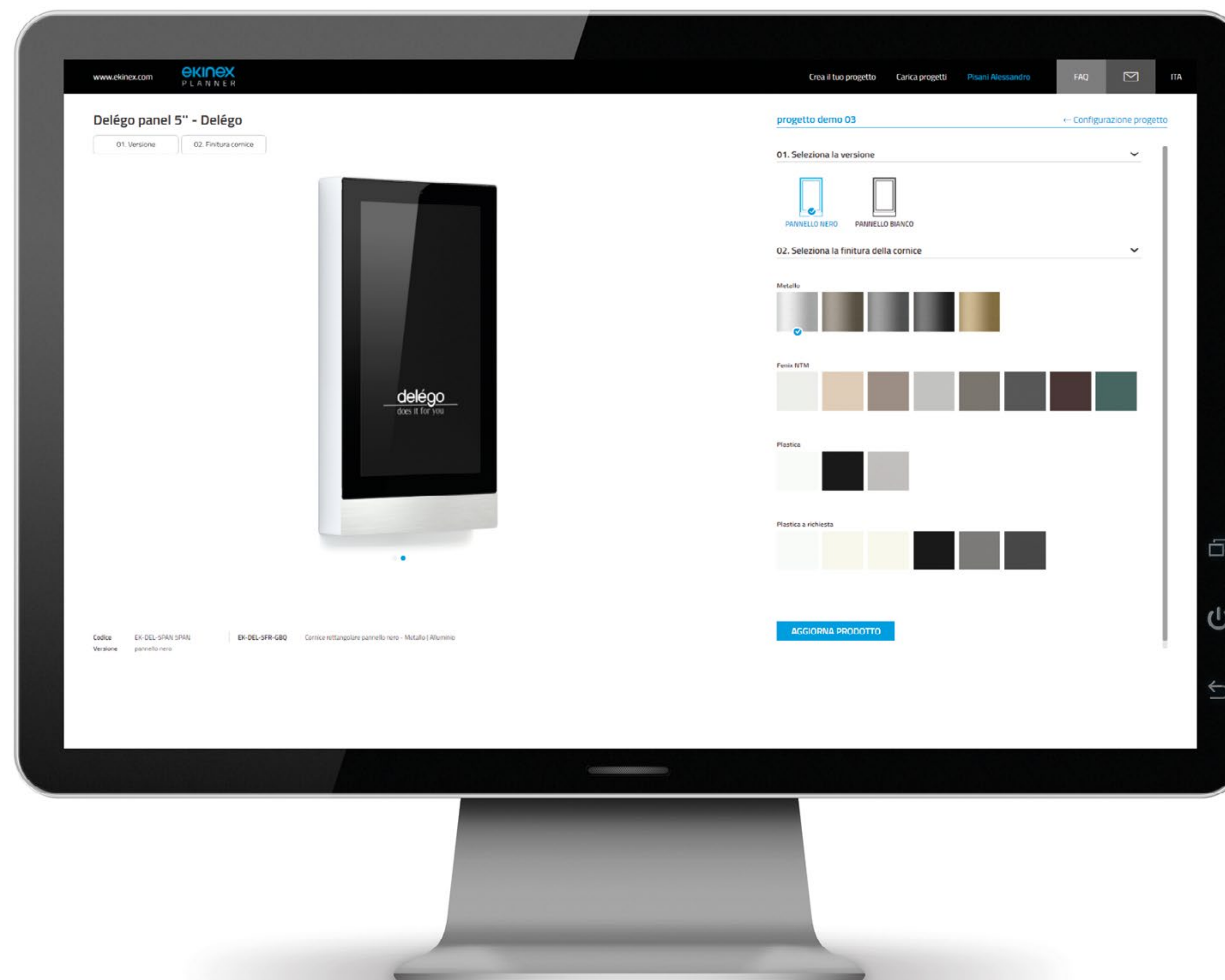



## Stylebox

Stylebox Delégo is a precious presentation box containing a 5" Delégo panel device with a working demo. It comes with a metal frame that can be customised according to the aesthetic finishes available.

Codice: **EK-SB4-5PAN**

**Ekinex S.p.A.**

Via Novara, 37

I-28010 Vaprio d'Agogna NO

T +39 0321 1828980

[info@ekinex.com](mailto:info@ekinex.com)

[www.ekinex.com](http://www.ekinex.com)