



Piano: in MDF, spessore mm 16, impiallacciato palissandro Santos* tinto Dark Brown, laccato poliestere opaco, con pannello distanziale in MDF nero, spessore mm 5.

Struttura: a ponte, portante, formata da uno scatolato di MDF e compensato, placcato con laminato verniciato color Golden Brown. All'interno rinforzo con tubolari di alluminio.

Cassettiera: in MDF, spessore mm 16, impiallacciato palissandro Santos* tinto Dark Brown, laccato poliestere opaco con maniglie in alluminio verniciato color Golden Brown.

La finitura interna dei cassetti è in tinta con la finitura esterna.

I cassetti (n. 2) scorrono su guide a estrazione totale con chiusura Blumotion. Il primo cassetto è dotato di serratura.

In corrispondenza del passacavi, sono fissati al sottopiano due supporti in metallo verniciato Golden Brown per raccogliere e indirizzare i cavi a destra o sinistra.

Versione con vassoio porta oggetti: sul piano è incassato un vassoio porta oggetti in metallo verniciato color Golden Brown con fondo rivestito in cuoio color Testa di Moro.

Pannello di cortesia: struttura in MDF e multistrato impiallacciato palissandro Santos* tinto Dark Brown laccato poliestere opaco dotato di passaggio interno per il cablaggio dei cavi. Piedini regolabili in metallo con scivolante protettivo in feltro nero.

* il palissandro Santos deriva da foreste correttamente gestite.

Top: in MDF, 16 mm thick, with palisander Santos* veneer, stained Dark Brown with polyester matt lacquer finish, with 5 mm thick black MDF spacer board.

Structure: self-supporting bridge structure made of boxed MDF and plywood, clad in laminate varnished Golden Brown colour. Internal reinforcement in tubular aluminium.

Drawers: in MDF, 16 mm thick, with palisander Santos* veneer, stained Dark Brown with polyester matt lacquer finish, aluminium handles varnished Golden Brown colour.

Interior finish of the drawers matches the exterior finish.

The drawers (n. 2) glide on full-extension runners with Blumotion closure.

The first drawer is equipped with a lock.

The top is equipped with a cable hole in MDF with lacquered Golden Brown finish.

Under the cable outlet there are two brackets made of Bolden Brown lacquered metal to collect the cables and route them to the left or right.

Version with valet tray: there is a valet tray made of Golden Brown lacquered metal embedded in the table top, the base is lined with Dark Brown saddle-hide.

Courtesy panel: MDF and plywood structure with palisander Santos* veneer, stained Dark Brown with polyester matt lacquer finish, with internal passage for the cables.

Adjustable metal feet with protective black felt slides.

* palisander Santos comes from properly managed forests.

Tischplatte: aus MDF, Stärke 16 mm, furniert mit Palisander Santos* Dark Brown gebeizt, mit matter Polyesterlackierung, mit schwarzer MDF-Distanzplatte, Stärke 5 mm.

Gestell: brückenförmig, tragend, bestehend aus innen hohlem MDF-Sperrholz, überzogen mit goldbraun lackiertem Laminat. Im Inneren verstärkt mit Aluminiumstangen.

Schubladenblock: aus MDF, Stärke 16 mm, furniert mit Palisander Santos* Dark Brown gebeizt, mit matter Polyesterlackierung, mit Griffen aus lackiertem Aluminium in der Farbe Goldbraun. Die innere Fläche der Schubladen ist farblich auf die Oberfläche der Außenseite abgestimmt.

Die Schubladen (2 Stk.) laufen auf Führungen mit Vollauszug und Blumotion-Verschluss. Die erste Schublade ist mit einem Schloss versehen. Die Platte hat eine Kabelführung aus goldbraun lackiertem MDF. Unter dem Kabeldurchlass befinden sich zwei Halterungen aus goldbraun lackiertem Metall, um die Kabel zu sammeln und nach links oder rechts zu leiten.

Version mit Schreibtisillenhalter: in die Tischplatte eingelassen befindet sich ein Schreibtisillenhalter aus goldbraun lackiertem Metall, der Grund ist mit Kernleder in der Farbe Dunkelbraun ausgekleidet.

Knieraumblende: Struktur aus MDF und Sperrholz furniert Palisander Santos* Dark Brown gebeizt, mit matter Polyesterlackierung, mit Innendurchgang für die Kabeldurchführung.

Verstellbare FüÙe aus Metall mit Schutzgleiter aus schwarzem Filz.

Plateau: en MDF, épaisseur 16 mm, plaqué palissandre de Santos* teinté Dark Brown, laqué polyester mat, avec entretoise en MDF noir, épaisseur 5 mm.

Structure: en forme de pont, porteuse, composée d'un caisson en MDF et contreplaqué, plaqué en laminé, laqué couleur Golden Brown. Intérieur renforcé d'aluminium tubulaire.

Caisson à tiroirs: en MDF, épaisseur 16 mm, plaqué palissandre de Santos* teinté Dark Brown, laqué polyester mat avec poignées en aluminium laqué couleur Golden Brown.

La finition interne des tiroirs est de la même couleur que la finition externe.

Les 2 tiroirs coulissent sur des glissières à extension complète avec fermeture Blumotion.

Le premier tiroir est équipé d'une serrure. Le plateau intègre un passe-câbles en MDF laqué couleur Golden Brown.

En correspondance du passe-câbles, deux supports en métal laqué Golden Brown sont fixés sous le plateau pour recueillir et canaliser les câbles à droite ou à gauche.

Version avec vide-poches: le plateau accueille un vide-poches, en métal laqué couleur Golden Brown avec fond revêtu en cuir-sellier couleur Marron Foncé.

Voile de fond: structure en MDF et multiplis plaqué palissandre de Santos* teinté Dark Brown, laqué polyester mat, équipé de passage interne pour le câblage des fils électriques.

Vérins réglables en métal et patins glisseurs en feutre noir.

* le palissandre de Santos provient de forêts bien gérées.

PIANO TOP

STRUTTURA E PASSACAVI STRUCTURE AND CABLE HOLE

PALISSANDRO SANTOS PALISANDER SANTOS

LEGGNO WOOD

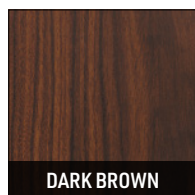

DARK BROWN

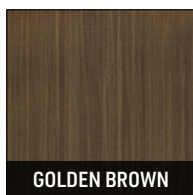

GOLDEN BROWN

CASSETTI | DRAWERS

VASSOIO PORTA OGGETTI | VALET TRAY

STRUTTURA INTERNA / ESTERNA INTERNAL / EXTERNAL STRUCTURE

MANIGLIE HANDLES

STRUTTURA STRUCTURE

FONDO BOTTOM

PANNELLO DI CORTESIA COURTESY PANEL

PALISSANDRO SANTOS PALISANDER SANTOS

ALLUMINIO ALUMINIUM

METALLO METAL

CUOIO SADDLE-HIDE

PALISSANDRO SANTOS PALISANDER SANTOS

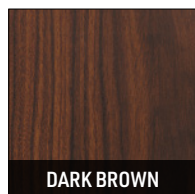

DARK BROWN

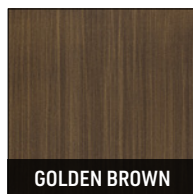

GOLDEN BROWN

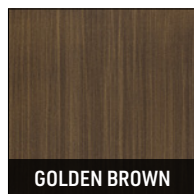

GOLDEN BROWN



TESTA DI MORO DARK BROWN

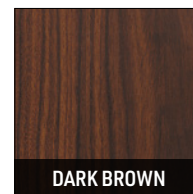

DARK BROWN

SCRITTOIO | WRITING DESK CM 180X65 H74

SCRITTOIO | WRITING DESK

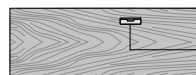
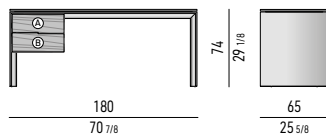

Foro passacavi | Cable hole
cm 20x6

CON VASSOIO PORTA OGGETTI | WITH VALET TRAY

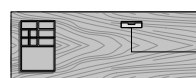
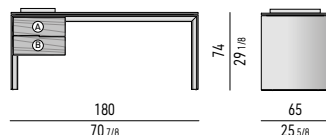

Foro passacavi | Cable hole
cm 20x6

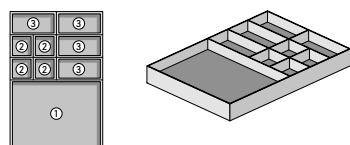

VASSOIO PORTA OGGETTI | VALET TRAY: CM 33X48 H3,8

Scomparto | section 1: cm 32x23,5 H3,3

Scomparto | section 2: cm 7,5x7,5 H3,3

Scomparto | section 3: cm 16x7,5 H3,3

CON PANNELLO DI CORTESIA | WITH MODESTY PANEL

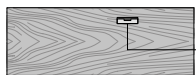
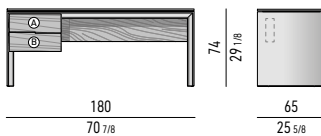

Foro passacavi | Cable hole
cm 20x6

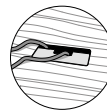

CON VASSOIO PORTA OGGETTI E PANNELLO DI CORTESIA | WITH VALET TRAY AND MODESTY PANEL

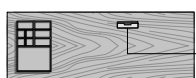
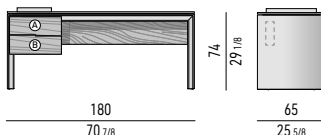

Foro passacavi | Cable hole
cm 20x6



Nr. 2 cassetti che scorrono su guide a estrazione totale con chiusura Blumotion.

Portata massima per cassetto Kg 30. Il cassetto (A) è dotato di serratura.

Spazio utile interno cassetti

(A): cm 37x51 H8

(B): cm 37x51 H11

Nr. 2 drawers that glide on fully extractable guides with Blumotion soft-close system.

Maximum load per drawer is 30 Kg. The drawer (A) is equipped with a lock.

Drawers internal dimension

(A): cm 37x51 H8

(B): cm 37x51 H11

SCRITTOIO | WRITING DESK CM 200X75 H74

SCRITTOIO | WRITING DESK

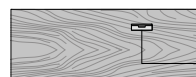
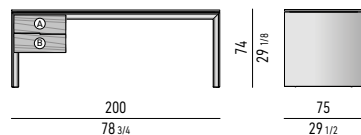

Foro passacavi | Cable hole
cm 20x6

CON VASSOIO PORTA OGGETTI | WITH VALET TRAY

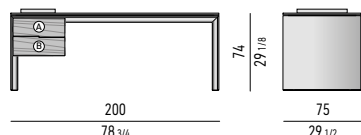

Foro passacavi | Cable hole
cm 20x6

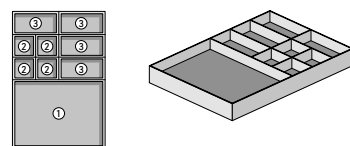

VASSOIO PORTA OGGETTI | VALET TRAY: CM 33X48 H3,8

Scomparto | section 1: cm 32x23,5 H3,3

Scomparto | section 2: cm 7,5x7,5 H3,3

Scomparto | section 3: cm 16x7,5 H3,3

CON PANNELLO DI CORTESIA | WITH MODESTY PANEL

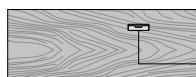
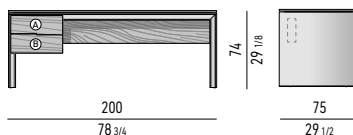

Foro passacavi | Cable hole
cm 20x6

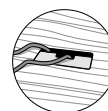

CON VASSOIO PORTA OGGETTI E PANNELLO DI CORTESIA | WITH VALET TRAY AND MODESTY PANEL

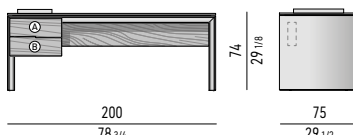

Foro passacavi | Cable hole
cm 20x6

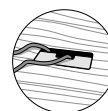

Nr. 2 cassetti che scorrono su guide a estrazione totale con chiusura Blumotion.

Portata massima per cassetto Kg 30. Il cassetto (A) è dotato di serratura.

Spazio utile interno cassetti

(A): cm 37x56 H8

(B): cm 37x56 H11

Nr. 2 drawers that glide on fully extractable guides with Blumotion soft-close system.

Maximum load per drawer is 30 Kg. The drawer (A) is equipped with a lock.

Drawers internal dimension

(A): cm 37x56 H8

(B): cm 37x56 H11

Minotti

SCRITTOIO | WRITING DESK CM 200X90 H74

SCRITTOIO | WRITING DESK

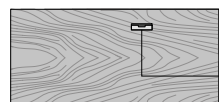
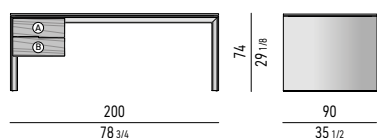

Foro passacavi | Cable hole
cm 20x6

CON VASSOIO PORTA OGGETTI | WITH VALET TRAY

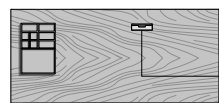
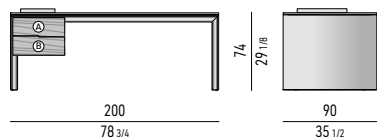

Foro passacavi | Cable hole
cm 20x6

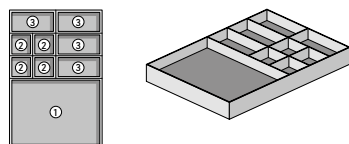

VASSOIO PORTA OGGETTI | VALET TRAY: CM 33X48 H3,8

Scomparto | section 1: cm 32x23,5 H3,3
Scomparto | section 2: cm 7,5x7,5 H3,3
Scomparto | section 3: cm 16x7,5 H3,3

CON PANNELLO DI CORTESIA | WITH MODESTY PANEL

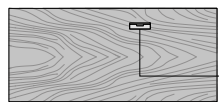
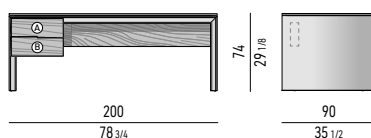

Foro passacavi | Cable hole
cm 20x6



CON VASSOIO PORTA OGGETTI E PANNELLO DI CORTESIA | WITH VALET TRAY AND MODESTY PANEL

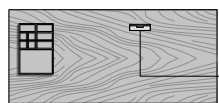
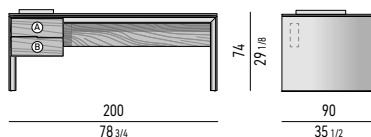

Foro passacavi | Cable hole
cm 20x6



Nr. 2 cassetti che scorrono su guide a estrazione totale con chiusura Blumotion. Portata massima per cassetto Kg 30. Il cassetto (A) è dotato di serratura.

Spazio utile interno cassetti

(A): cm 37x56 H8
(B): cm 37x56 H11

Nr. 2 drawers that glide on fully extractable guides with Blumotion soft-close system. Maximum load per drawer is 30 Kg. The drawer (A) is equipped with a lock.

Drawers internal dimension

(A): cm 37x56 H8
(B): cm 37x56 H11

SCRITTOIO | WRITING DESK CM 250X90 H74

SCRITTOIO | WRITING DESK

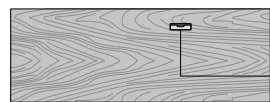
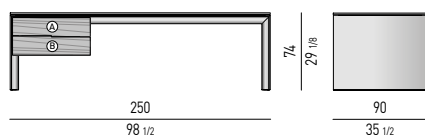

Foro passacavi | Cable hole
cm 20x6

CON VASSOIO PORTA OGGETTI | WITH VALET TRAY

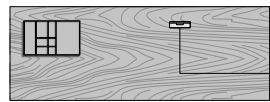
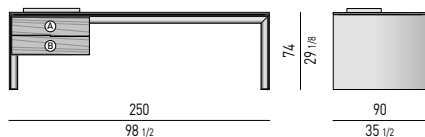

Foro passacavi | Cable hole
cm 20x6

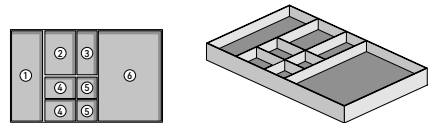

VASSOIO PORTA OGGETTI | VALET TRAY: CM 54X33 H3,8

Scomparto | section 1: cm 11x32 H3,3
Scomparto | section 2: cm 11x16 H3,3
Scomparto | section 3: cm 7x16 H3,3
Scomparto | section 4: cm 11x7,5 H3,3
Scomparto | section 5: cm 7x7,5 H3,3
Scomparto | section 6: cm 22,5x32 H3,3

CON PANNELLO DI CORTESIA | WITH MODESTY PANEL

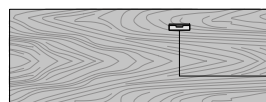
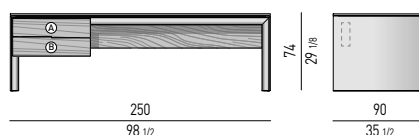

Foro passacavi | Cable hole
cm 20x6



CON VASSOIO PORTA OGGETTI E PANNELLO DI CORTESIA | WITH VALET TRAY AND MODESTY PANEL

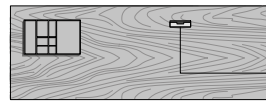
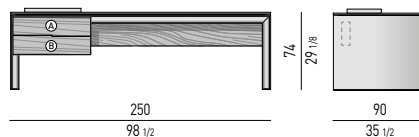

Foro passacavi | Cable hole
cm 20x6



Nr. 2 cassetti che scorrono su guide a estrazione totale con chiusura Blumotion. Portata massima per cassetto Kg 30. Il cassetto (A) è dotato di serratura.

Spazio utile interno cassetti

(A): cm 61x56 H8
(B): cm 61x56 H12

Nr. 2 drawers that glide on fully extractable guides with Blumotion soft-close system. Maximum load per drawer is 30 Kg.

The drawer (A) is equipped with a lock.

Drawers internal dimension

(A): cm 61x56 H8
(B): cm 61x56 H12

SCRITTOIO | WRITING DESK CM 250X110 H74

SCRITTOIO | WRITING DESK

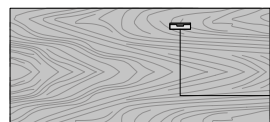
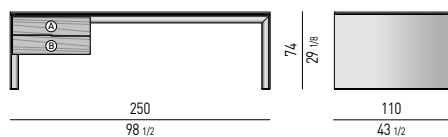

Foro passacavi | Cable hole
cm 20x6

CON PANNELLO DI CORTESIA | WITH MODESTY PANEL

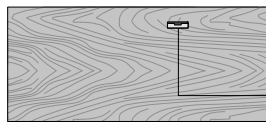
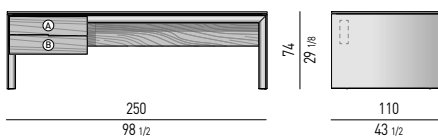

Foro passacavi | Cable hole
cm 20x6

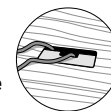

CON VASSOIO PORTA OGGETTI | WITH VALET TRAY

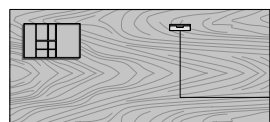
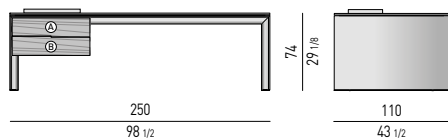

Foro passacavi | Cable hole
cm 20x6

CON VASSOIO PORTA OGGETTI E PANNELLO DI CORTESIA | WITH VALET TRAY AND MODESTY PANEL

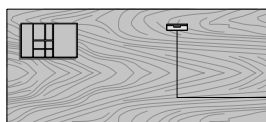
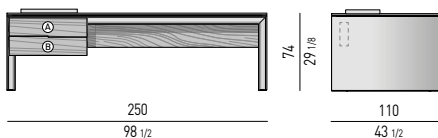

Foro passacavi | Cable hole
cm 20x6

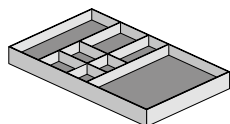
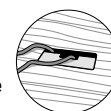

VASSOIO PORTA OGGETTI | VALET TRAY: CM 54X33 H3,8

- Scomparto | section 1: cm 11x32 H3,3
- Scomparto | section 2: cm 11x16 H3,3
- Scomparto | section 3: cm 7x16 H3,3
- Scomparto | section 4: cm 11x7,5 H3,3
- Scomparto | section 5: cm 7x7,5 H3,3
- Scomparto | section 6: cm 22,5x32 H3,3

Nr. 2 cassetti che scorrono su guide a estrazione totale con chiusura Blumotion.

Portata massima per cassetto Kg 30.

Il cassetto **(A)** è dotato di serratura.

Spazio utile interno cassetti

(A): cm 61x56 H8

(B): cm 61x56 H12

Nr. 2 drawers that glide on fully extractable guides with Blumotion soft-close system.

Maximum load per drawer is 30 Kg.

The drawer **(A)** is equipped with a lock.

Drawers internal dimension

(A): cm 61x56 H8

(B): cm 61x56 H12

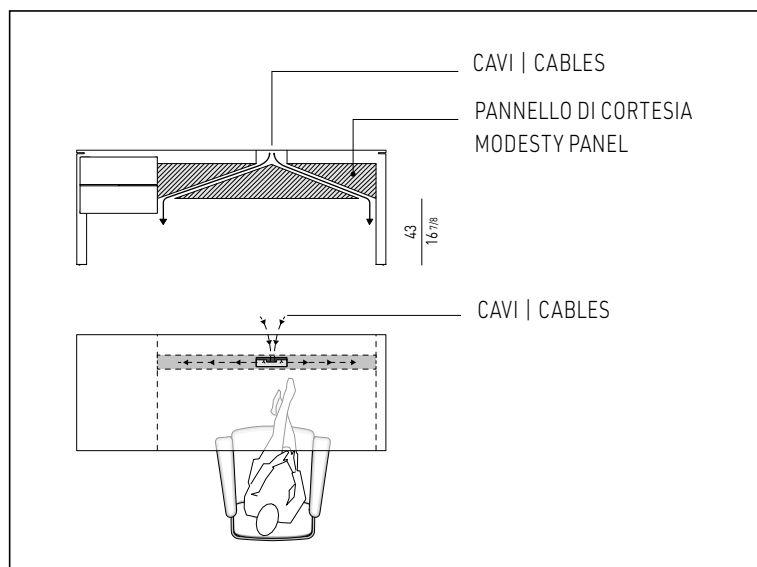

CAVI | CABLES

PANNELLO DI CORTESIA
MODESTY PANEL

CAVI | CABLES

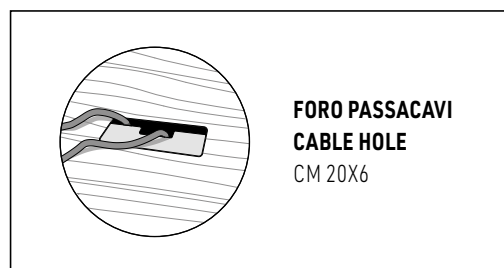

**FORO PASSACAVI
CABLE HOLE**
CM 20X6

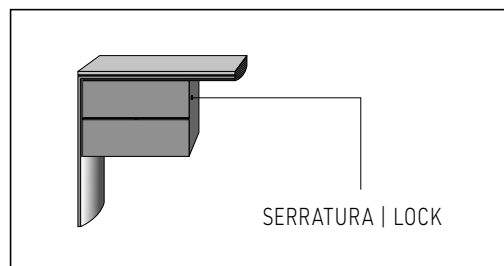

SERRATURA | LOCK