



LIDO CORD OUTDOOR

Struttura: in tubolare di acciaio inox AISI 316 verniciato color Bronzo con finitura lucida anti-touch. La struttura in acciaio è rivestita da un filato di polipropilene intrecciato Taslan (processo di testurizzazione a getto d'aria), Ø mm 8. Il filato è disponibile nei colori Sand, Testa di Moro, Petrolio, Blu e Cedro.

Cuscineria: cuscini sedile e schienale in poliuretano espanso ad alta resilienza e viscofibra idrorepellente eocompatibile. Al fine di migliorare la protezione delle imbottiture da acqua e umidità, tutti i cuscini sono rivestiti con una fodera in poliestere con trattamento idrorepellente. Tutti gli accessori utilizzati per la confezione - cerniere, filo - sono idrorepellenti e pertanto idonei all'utilizzo outdoor.

I cuscini sedile e schienale della poltrona cm 88x95 H82 sono reversibili.

Sfoderabilità: il rivestimento dei cuscini è completamente sfoderabile.

Base divano: in alluminio verniciato Bronzo con finitura lucida anti-touch. Scivolante protettivo in polietilene.

Gambe poltrona/poltroncine/

poggiapiedi: in massello di mogano Dark Brown o in massello di teak (Tectona Grandis - First European Quality), finitura naturale. Un inserto decorativo in acciaio verniciato Bronzo è presente nella parte superiore delle gambe.

Scivolante protettivo in polietilene.

LIDO OUTDOOR - TAVOLINI

Piano: in pietra Basaltina, spessore mm 20, spazzolata a grana fine, supportato da un foglio di alluminio, spessore mm 2. Il piano in pietra viene sottoposto ad un trattamento antimacchia, che tuttavia non ne garantisce la totale protezione.

Base: in alluminio, spessore mm 15, verniciato Bronzo con finitura lucida anti-touch.

Scivolante protettivo in polietilene.

LIDO CORD OUTDOOR

Structure: in AISI 316 tubular stainless steel varnished polished Bronze colour with anti-fingerprint finish. The steel structure is upholstered in woven Taslan (air-jet weaving and texturization process) 8 mm Ø polypropylene cord. The cord is available in Sand, Dark Brown, Petroleum, Blue and Citron colour.

Cushions: seat and backrest cushions in high-resilience polyurethane foam and water-repellent, eco-friendly viscose fibre. In order to better protect the padding from water and humidity, all the cushions are upholstered in water-repellent polyester fabric.

All the accessories used in production - zippers, thread - are water-repellent and therefore suitable for outdoor use. The seat and backrest cushions of the 88x95 H82 cm armchair are reversible.

Covers: cushion upholstery is completely removable.

Sofa base: in varnished polished Bronze colour aluminium with anti-fingerprint finish. Protective polyethylene glides.

Legs - armchair/little armchairs/ footstool: in solid mahogany Dark Brown or in solid natural teak (Tectona Grandis - First European Quality). The upper part of the legs is embellished with a decorative steel insert with varnished Bronze colour finish. Protective polyethylene glides.

LIDO OUTDOOR - COFFEE TABLES

Top: in fine grain brushed Basaltina stone, 20 mm thick, supported by aluminium sheet, 2 mm thick.

The top is then given a stain-resistant treatment which does not, however, guarantee total stain protection.

Base: in aluminium, 15 mm thick, varnished Bronze colour with polished anti-fingerprint finish. Protective polyethylene glides.

LIDO CORD OUTDOOR

Gestell: aus Edelstahlrohr AISI 316 mit Lackierung in der Farbe Bronze mit glänzender Anti Touch Oberfläche. Das Stahlgestell ist mit einem gewebten Taslan-Polypropylengarn (Luftstrahl-Texturierverfahren), Ø 8 mm, ummantelt. Das Garn ist in den Farben Sand, Dunkelbraun, Petrol, Blau und Zedernholz erhältlich.

Kissen: Sitzkissen und Rückenissen aus hochwiderstandsfähigem PU-Schaum und umweltfreundlicher, wasserabweisender Viskose-Faser. Zum Schutz der Polsterung vor Wasser und Feuchtigkeit verfügen alle Kissen über einen Polyesterbezug mit wasserabweisender Behandlung. Alle für die Konfektionierung verwendeten Accessoires (Reißverschlüsse, Garn) sind wasserabweisend und daher für den Outdoor-Bereich geeignet. Die Sitz- und Rückenissen des Sessels 88x95xh82 cm sind wendbar.

Abziehbarkeit: Der Bezug der Kissen ist komplett abziehbar.

Sofa-Basis: aus Aluminium mit glänzender Anti Touch-Lackierung in der Farbe Bronze. Schutzgleiter aus Polyethylen.

Beine Sessel/Armsessel/Hocker: in massivem dunkelbraunem Mahagoni oder in massivem Teakholz (Tectona Grandis - First European Quality), naturbelassen. An der Oberseite der Beine befindet sich ein dekorativer Einsatz aus bronzefarben lackiertem Stahl. Schutzgleiter aus Polyethylen.

LIDO OUTDOOR - BEISTELLTISCHE

Oberfläche: aus Basaltstein, Stärke 20 mm, gebürstet mit feiner Körnung, getragen von einem Aluminiumblech, Stärke 2 mm. Der Stein wird mit einem Fleckenschutz imprägniert, der aber keine volle Versiegelung garantiert.

Basis: aus Aluminium, 15 mm, mit glänzender Anti Touch-Lackierung in der Farbe Bronze. Schutzgleiter aus Polyethylen.

LIDO CORD OUTDOOR

Structure : en tube d'acier inox AISI 316, peint de couleur Bronze finition brillante anti-traces de doigt.

La structure en acier est recouverte d'un fil de polypropylène tressé Taslan (procédé de texturation par jet d'air), Ø 8 mm. Le fil est disponible dans les couleurs suivantes : Sand, Marron Foncé, Pétrole, Bleu et Cèdre.

Coussins : coussins d'assise et de dossier en mousse de polyuréthane haute résilience et viscofibre déperlante éocompatible. Afin d'améliorer la protection des rembourrages contre l'eau et l'humidité, tous les coussins sont recouverts d'une housse en polyester traité déperlant.

Tous les accessoires utilisés pour la confection - fermetures à glissière, fil - sont déperlants et donc adaptés à une utilisation en extérieur. Les coussins d'assise et de dossier du fauteuil 88x95 H82 cm sont réversibles.

Déhoussage : le revêtement des coussins est entièrement déhoussable.

Piètements canapé : en aluminium peint couleur Bronze finition brillante anti-traces de doigt.

Patins glisseurs en polyéthylène.

Pieds fauteuil / petit fauteuils / repose-pied : en acajou massif Dark Brown ou en teck massif (Tectona Grandis - First European Quality), finition naturelle. La partie supérieure des pieds arbore un insert décoratif en acier peint couleur Bronze. Patins glisseurs en polyéthylène.

LIDO OUTDOOR - PETITES TABLES

Plateau : en pierre de Basalte, épaisseur 20 mm, brossée grain fin, soutenue par une feuille d'aluminium, épaisseur 2 mm. Le plateau en pierre est sujet au traitement anti-tache, qui toutefois ne garantit pas une protection totale.

Piètements : en aluminium, épaisseur 15 mm, peint couleur Bronze finition brillante anti-traces de doigt. Patins glisseurs en polyéthylène.



INFORMAZIONI TECNICHE SULLA PIETRA BASALTINA

DATA LA POROSITÀ DI QUESTA PIETRA NATURALE DI ORIGINE LAVICA, POSSONO ESSERE PRESENTI SULLA SUPERFICIE PICCOLI FORI E APERTURE. TALI DIFFORMITÀ NON DEVONO ESSERE CONSIDERATE DIFETTI MA CARATTERISTICHE INTRINSECHE DEL MATERIALE STESSO.

TECHNICAL INFORMATION ABOUT BASALTINA STONE

GIVEN THE POROSITY OF THIS NATURAL LAVA STONE, TINY HOLES AND OPENINGS MAY APPEAR ON THE SURFACE. THESE DISPARITIES SHOULD NOT BE CONSIDERED FLAWS BUT RATHER FEATURES INHERENT TO THE MATERIAL ITSELF.

RIVESTIMENTO STRUTTURA STRUCTURE COVER

FILATO IN POLIPROPILENE POLYPROPYLENE FIBER

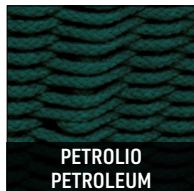
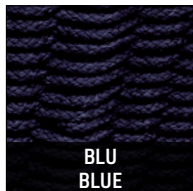

BASE DIVANO SOFA BASE

ALLUMINIO LUCIDO POLISHED ALUMINIUM

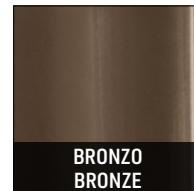

Minotti

LIDO CORD OUTDOOR

DIVANO LOUNGE SEMICURVO | SEMI-ROUND LOUNGE SOFA

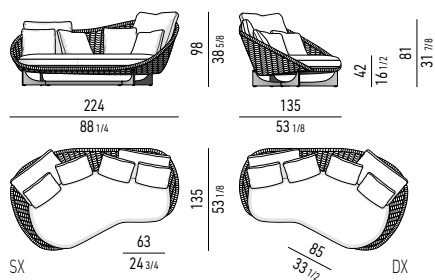

POLTRONA | ARMCHAIR

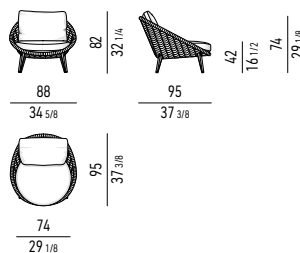

POGGIAPIEDI | FOOTSTOOL

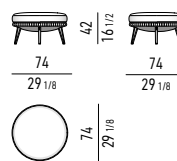

POLTRONCINA LOUNGE | LOUNGE LITTLE ARMCHAIR

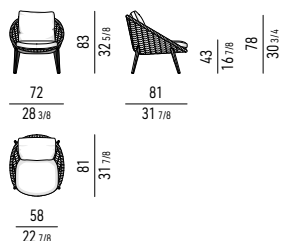

POLTRONCINA DINING | DINING LITTLE ARMCHAIR

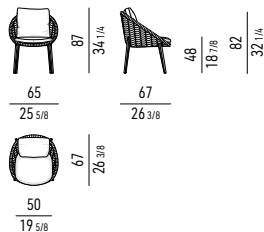

LIDO OUTDOOR

TAVOLINI | COFFEE TABLES

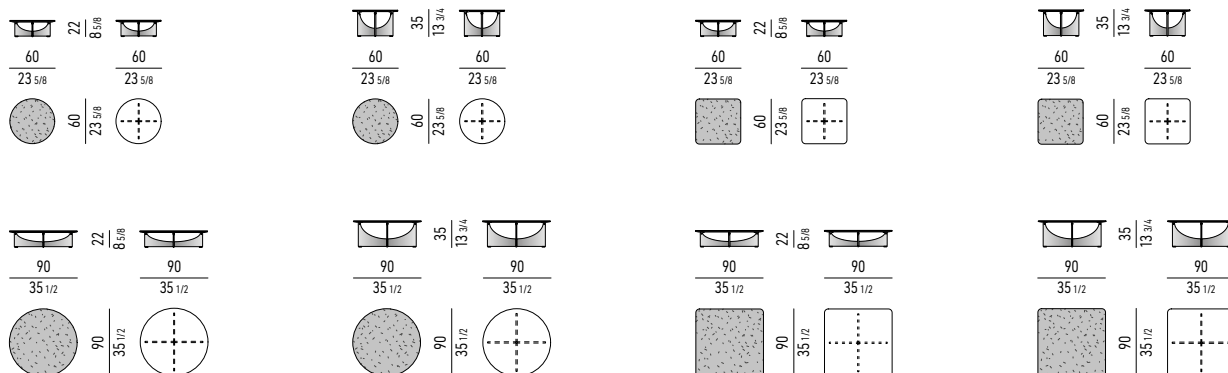

OPTIONAL RAIN COVER



Disponibile per ogni elemento
Available for each element

GAMBE SEDUTE SEATS LEGS

MOGANO
MAHOGANY

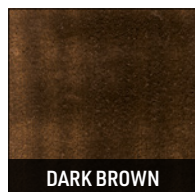

TEAK

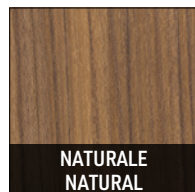

INSERTO DECORATIVO GAMBE LEGS DECORATIVE INSERT

ACCIAIO
STEEL

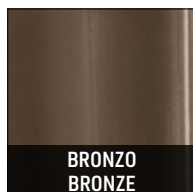

TAVOLINI | COFFEE TABLES

PIANO
TOP

PIETRA
STONE



BASE
BASE

ALLUMINIO LUCIDO
POLISHED ALUMINIUM

