

Hedge Trimmer Safety Manual

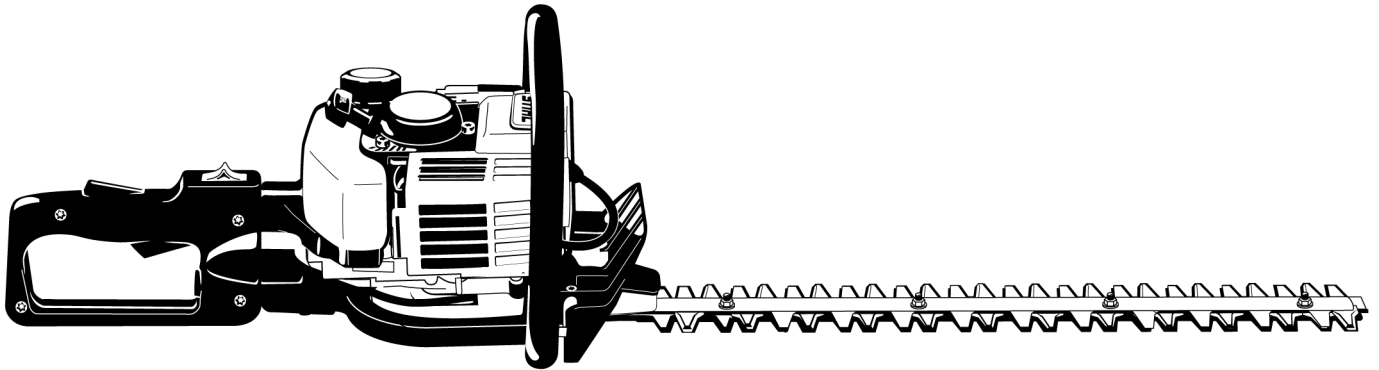

Contents

Safety Precautions and Working Techniques	2
Using the Unit	10
Maintenance and Care	12
Main Parts	14

This manual contains the safety precautions and recommended cutting techniques outlined in STIHL instruction manuals for gasoline-powered hedge trimmers. Even if you are an experienced hedge trimmer user, it is in your own interest to familiarize yourself with the latest instructions and safety precautions regarding your hedge trimmer.

Please note that the illustrations in the chapters "Using the Unit" and "Main Parts and Controls" in this manual show the hedge trimmer STIHL HS 81.

Other hedge trimmer models may have different parts and controls. You should therefore always refer to the instruction manual of your particular hedge trimmer model.

Contact your STIHL dealer or the STIHL distributor for your area if you do not understand any of the instructions in this manual.



Safety Precautions and Working Techniques



Because a hedge trimmer is a high-speed, fast-cutting power tool with sharp cutting blades, special safety precautions must be observed to reduce the risk of personal injury.



It is important that you read, fully understand and observe the following safety precautions and warnings. Read the instruction manual and the safety precautions periodically. Careless or improper use may cause serious or fatal injury.

Have your STIHL dealer show you how to operate your power tool. Observe all applicable local safety regulations, standards and ordinances.



Warning!

Do not lend or rent your power tool without the instruction manual. Be sure that anyone using it understands the information contained in this manual.



Warning!

The use of this machine may be hazardous. If the cutting tool comes in contact with your body, it will cut you.

Use your hedge trimmer only for cutting hedges, shrubs, scrub, bushes and similar material.



Warning!

Do not use it for other purposes, since misuse may result in personal injury or property damage, including damage to the machine.



Warning!

Minors should never be allowed to use this power tool. Bystanders, especially children, and animals should not be allowed in the area where it is in use.



Warning!

To reduce the risk of injury to bystanders and damage to property, never let your power tool run unattended. When it is not in use (e.g. during a work break), shut it off and make sure that unauthorized persons do not use it.

Most of these safety precautions and warnings apply to the use of all STIHL hedge trimmers. Different models may have different parts and controls. See the appropriate section of your instruction manual for a description of the controls and the function of the parts of your model.

Do not clean your machine with a pressure washer. The solid jet of water may damage parts of the machine.

Safe use of a hedge trimmer involves

1. the operator
2. the power tool
3. the use of the power tool.

THE OPERATOR

Physical Condition

You must be in good physical condition and mental health and not under the influence of any substance (drugs, alcohol, etc.) which might impair vision, dexterity or judgment. Do not operate this machine when you are fatigued.



Warning!

Be alert – if you get tired, take a break. Tiredness may result in loss of control. Working with any power tool can be strenuous. If you have any condition that might be aggravated by strenuous work, check with your doctor before operating this machine.



Warning!

Prolonged use of a power tool (or other machines) exposing the operator to vibrations may produce whitefinger disease (Raynaud's phenomenon) or carpal tunnel syndrome.

These conditions reduce the hand's ability to feel and regulate temperature, produce numbness and burning sensations and may cause nerve and circulation damage and tissue necrosis.

All factors which contribute to whitefinger disease are not known, but cold weather, smoking and diseases or physical conditions that affect blood vessels and blood transport, as well as high vibration levels and long periods of exposure to vibration are mentioned as factors in the development of whitefinger

disease. In order to reduce the risk of whitefinger disease and carpal tunnel syndrome, please note the following:

- Most STIHL power tools are available with an anti-vibration ("AV") system designed to reduce the transmission of vibrations created by the machine to the operator's hands. An AV system is recommended for those persons using power tools on a regular or sustained basis.
- Wear gloves and keep your hands warm.
- Keep the AV system well maintained. A power tool with loose components or with damaged or worn AV elements will tend to have higher vibration levels.
- Maintain a firm grip at all times, but do not squeeze the handles with constant, excessive pressure. Take frequent breaks.

All the above-mentioned precautions do not guarantee that you will not sustain whitefinger disease or carpal tunnel syndrome. Therefore, continual and regular users should closely monitor the condition of their hands and fingers. If any of the above symptoms appear, seek medical advice immediately.

 **Warning!**

The ignition system of the STIHL unit produces an electromagnetic field of a very low intensity. This field may interfere with some pacemakers. To reduce the risk of serious or fatal injury, persons with a pacemaker should consult their physician and the pacemaker manufacturer before operating this tool.

Proper Clothing

 **Warning!**

To reduce the risk of injury, the operator should wear proper protective apparel.

 **Warning!**



To reduce the risk of injury to your eyes never operate your power tool unless wearing goggles or properly fitted protective glasses with

adequate top and side protection complying with ANSI Z 87.1 (or your applicable national standard.) To reduce the risk of injury to your face STIHL recommends that you also wear a face shield or face screen over your goggles or protective glasses.

 **Warning!**



Power tool noise may damage your hearing. Wear sound barriers (earplugs or ear muffers) to protect your hearing. Continual and regular users should have their hearing checked regularly.

Be particularly alert and cautious when wearing hearing protection because your ability to hear warnings (shouts, alarms, etc.) is restricted.



Always wear gloves when handling the machine and the cutting tool. Heavy-duty, nonslip gloves improve your grip and help to protect your hands.

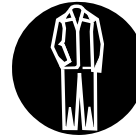

Clothing must be sturdy and snug-fitting, but allow complete freedom of movement. Wear long pants made of heavy material to help protect your legs. Do not wear shorts, sandals or go barefoot.



Avoid loose-fitting jackets, scarfs, neckties, jewelry, flared or cuffed pants, unconfined long hair or anything that could become caught on branches, brush or the moving parts of the unit. Secure hair so it is above shoulder level.



Good footing is very important. Wear sturdy boots with nonslip soles. Steel-toed safety boots are recommended.

THE POWER TOOL

For illustrations and definitions of the power tool parts see the chapter on "Main Parts".



Warning!

Never modify this power tool in any way. Only attachments supplied by STIHL or expressly approved by STIHL for use with the specific STIHL model are authorized. Although certain unauthorized attachments are useable with STIHL power tools, their use may, in fact, be extremely dangerous.

If this tool is subjected to unusually high loads for which it was not designed (e.g. heavy impact or a fall), always check that it is in good condition before continuing work. Check in particular that the fuel system is tight (no leaks) and that the controls and safety devices are working properly. Do not continue operating this machine if it is damaged. In case of doubt, have it checked by your STIHL servicing dealer.

THE USE OF THE POWER TOOL

Transporting the Power Tool



Warning!

To reduce the risk of injury from blade contact, never carry or transport your power tool with the cutter blades moving.

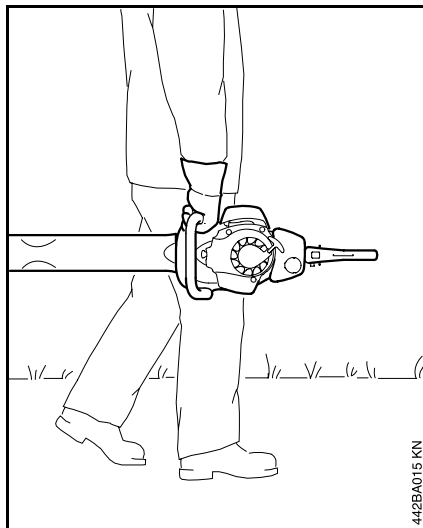

It may be carried only in the horizontal position. Grip the front handle and keep the hot muffler away from your body and the cutter blades behind you.



Warning!

Always switch off the engine and fit the scabbard over the cutter blades before transporting the power tool over long distances. When transporting it in a vehicle, properly secure it to prevent turnover, fuel spillage and damage to the unit.

Fuel

Your STIHL power tool uses an oil-gasoline mixture for fuel (see the chapter on "Fuel" of your instruction manual.)



Warning!



Gasoline is an extremely flammable fuel. If spilled and ignited by a spark or other ignition source, it can cause fire and serious burn injury or

property damage. Use extreme caution when handling gasoline or fuel mix. Do not smoke or bring any fire or flame near the fuel or the power tool. Note that combustible fuel vapor may escape from the fuel system.

Fueling Instructions



Warning!

Fuel your power tool in well-ventilated areas, outdoors. Always shut off the engine and allow it to cool before refueling. Gasoline vapor pressure may build up inside the fuel tank depending on the fuel used, the weather conditions and the tank venting system.

In order to reduce the risk of burns and other personal injury from escaping gas vapor and fumes, remove the fuel filler cap on your power tool carefully so as to allow any pressure build-up in the tank to release slowly. Never remove the fuel filler cap while the engine is running.

Select bare ground for fueling and move at least 10 feet (3 m) from the fueling spot before starting the engine. Wipe off any spilled fuel before starting your machine.

Warning!

Check for fuel leakage while refueling and during operation. If fuel leakage is found, do not start or run the engine until the leak is fixed and any spilled fuel has been wiped away. Take care not to get fuel on your clothing. If this happens, change your clothing immediately.

Different models may be equipped with different fuel caps.

Cap with Grip

Warning!

In order to reduce the risk of fuel spillage and fire from an improperly tightened fuel cap, correctly position and tighten the fuel cap in the fuel tank opening.



To do this with this STIHL cap, raise the grip on the top of the cap until it is upright at a 90° angle. Insert the cap in the fuel tank opening with the triangular marks on the grip of the cap and on the fuel tank opening lining up. Using the grip, turn the cap firmly clockwise as far as it will go (approx. a quarter turn.)



Fold the grip flush with the top of the cap. If the grip does not lie completely flush with the cap and the detent on the grip does not fit in the corresponding recess in the filler opening, the cap is not properly seated and tightened and you must repeat the above steps.

Screw Cap

Warning!



Unit vibrations can cause an improperly tightened fuel filler cap to loosen or come off and spill quantities of fuel. In order to reduce the risk of fuel spillage and fire, tighten the fuel filler cap by hand as securely as possible.

Before Starting

Warning!

Always check your power tool for proper condition and operation before starting, particularly the throttle trigger, throttle trigger lockout, stop switch and cutting tool. The throttle trigger (if applicable) must move freely and always spring back to the idle position. Never attempt to modify the controls or safety devices.

Warning!

Never use a power tool that is damaged or not properly maintained.

Warning!

Check that the spark plug boot is securely mounted on the spark plug – a loose boot may cause arcing that could ignite combustible fumes and cause a fire.

Keep the handles clean and dry at all times; it is particularly important to keep them free of moisture, pitch, oil, fuel mix, grease or resin in order for you to maintain a firm grip and properly control your power tool.

Warning!

The cutting tool must be properly tightened and in safe operating condition. Inspect for loose parts (nuts, screws, etc.) and for cracked, bent, warped or damaged blades. Regularly check the condition and tightness of the cutter blades – with the engine stopped! Replace damaged cutter blades before using the power tool. Always keep blades sharp.

STIHL recommends that you always spray the cutter blades with STIHL resin solvent before starting work – with the engine stopped! You can obtain this protective spray from your dealer. Apply generously.

Starting

Start the engine at least 10 feet (3 m) from the fueling spot, outdoors only.

For specific starting instructions, see the appropriate section of your manual. Place the power tool on firm ground or other solid surface in an open area. Maintain good balance and secure footing.

Warning!

To reduce the risk of injury from blade contact, be absolutely sure that the cutting tool is clear of you and all other obstructions and objects, including the ground, because when the engine starts at starting-throttle, engine speed will be fast enough for the clutch to engage and move the blades on the cutting tool.

Once the engine has started, immediately blip the throttle trigger, which should release the starting throttle and allow the engine to slow down to idle.

Warning!

Your power tool is a one-person machine. Do not allow other persons in the general work area, even when starting.

Warning!

To reduce the risk of injury from loss of control, do not attempt to "drop start" your power tool.

Warning!

When you pull the starter grip, do not wrap the starter rope around your hand. Do not let the grip snap back, but guide the starter rope to rewind it properly. Failure to follow this procedure may result in injury to your hand or fingers and may damage the starter mechanism.

Important Adjustments

Warning!

To reduce the risk of personal injury from loss of control or contact with the running cutting tool, do not use your unit with incorrect idle adjustment. At correct idle speed, the cutting tool should not move. For directions on how to adjust idle speed, see the appropriate section of your instruction manual.

If you cannot set the correct idle speed, have your STIHL dealer check your power tool and make proper adjustments and repairs.

During Operation

Holding and Controlling the Power Tool

Always hold the unit firmly with both hands on the handles while you are working. Wrap your fingers and thumbs around the handles.

Right-hand Use

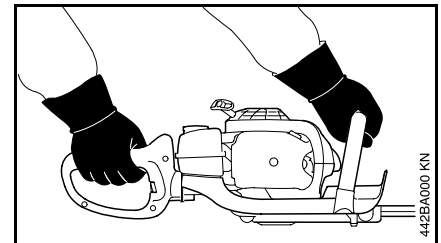

Put your right hand on the rear handle, left hand on the front handle.

Operate the machine so that the cutting blades are always away from your body.

Left-hand Use

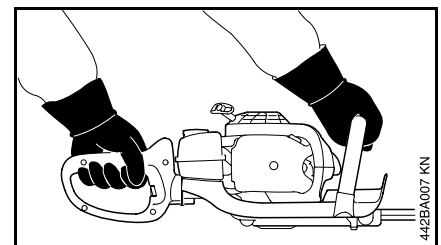

Put your left hand on the rear handle, right hand on the front handle.

 **Warning!**

Never attempt to operate your power tool with one hand. Loss of control of the power tool resulting in serious or fatal injury may result. To reduce the risk of cut injuries, keep hands and feet away from the cutting tool. Never touch a moving cutting tool with your hand or any other part of your body.

 **Warning!**

Do not overreach. Keep proper footing and balance at all times. Special care must be taken in slippery conditions (wet ground, snow) and in difficult, overgrown terrain. Watch for hidden obstacles such as tree stumps, roots and ditches to avoid stumbling. For better footing, clear away fallen branches, scrub and cuttings. Be extremely cautious when working on slopes or uneven ground.

 **Warning!**

To reduce the risk of injury from loss of control, never work on a ladder, in a tree or any other insecure support. Never hold the machine above shoulder height.

Working Conditions

Operate and start your power tool only outdoors in a well ventilated area. Operate it under good visibility and daylight conditions only. Work carefully.

 **Warning!**

As soon as the engine is running, this product generates toxic exhaust fumes containing chemicals, such as unburned hydrocarbons (including benzene) and carbon monoxide, that are known to cause respiratory problems, cancer, birth defects, or other reproductive harm.. Some of the gases (e.g. carbon monoxide) may be colorless and odorless. To reduce the risk of serious or fatal injury / illness from inhaling toxic fumes, never run the machine indoors or in poorly ventilated locations.

 **Warning!**

If the vegetation being cut or the surrounding ground is coated with a chemical substance (such as an active pesticide or herbicide), read and follow the instructions and warnings that accompanied the substance at issue.

 **Warning!**

Inhalation of certain dusts, especially organic dusts such as mold or pollen, can cause susceptible persons to have an allergic or asthmatic reaction. Substantial or repeated inhalation of dust and other airborne contaminants, in particular those with a smaller particle size, may cause respiratory or other illnesses. Control dust at the source where possible. Use good work practices, such as operating the unit so that the wind or operating process directs any dust raised by the power tool away from the operator. Follow the recommendations of EPA / OSHA / NIOSH and occupational and trade associations with respect to dust ("particulate matter".) When the inhalation of dust cannot be substantially controlled, i.e., kept at or near the ambient (background) level, the operator and any bystanders should wear a respirator approved by NIOSH / MSHA for the type of dust encountered.

Operating Instructions

 **Warning!**

Do not operate your power tool using the starting throttle lock, as you do not have control of the engine speed.

In the event of an emergency, switch off the engine immediately – move the slide control / stop switch to **0** or **STOP**.

 **Warning!**

The cutter blades continue to move for a short period after the throttle trigger is released (flywheel effect.)

Accelerating the engine while the blades are blocked increases the load and will cause the clutch to slip continuously. This may result in overheating and damage to important components (e.g. clutch, polymer housing components) – which can then increase the risk of injury from the blades moving while the engine is idling.

 **Warning!**

Before you start work, examine the hedge area for stones, fence wire, metal or other solid objects which could damage the cutter blades.

Take particular care when cutting hedges next to or against wire fences. Do not touch the wire with the cutting blades. When working close to the ground, make sure that no sand, grit or stones get between the cutter blades.

Striking solid foreign objects such as stones, fence wire or metal could damage the cutting attachment and may cause blades to crack, chip or break. STIHL does not recommend the use of your power tool when cutting in areas where the blades could contact such objects.

 **Warning!**

Observe the cutting blades at all times – do not cut any areas of the hedge that you cannot see. When cutting the top of a taller hedge, check the other side of the hedge frequently for bystanders, animals and obstructions.

 **Danger!**



Your power tool is not insulated against electric shock. To reduce the risk of electrocution, never operate this power tool in the vicinity of any wires or cables (power, etc.) which may be carrying electric current.

 **Warning!**

If the cutting tool becomes clogged or stuck, always turn off the engine and make sure the cutting tool has stopped before cleaning. Grass, weeds, etc. should be cleaned off the cutting tool at regular intervals.

Check the cutting blades at regular short intervals during operation, or immediately if there is a noticeable change in cutting behavior:

- Shut off the engine.
- Wait until the cutting blades have come to a complete standstill.
- Check condition and tightness, look for cracks.
- Check sharpness.
- Replace damaged or dull cutting tools immediately, even if they have only superficial cracks.

 **Warning!**

The gearbox becomes hot during operation. To reduce the risk of burn injury, do not touch the gear housing when it is hot.

 **Warning!**

The muffler and other parts of the engine (e.g. fins of the cylinder, spark plug) become hot during operation and remain hot for a while after stopping the engine. To reduce risk of burns do not touch the muffler and other parts while they are hot.

 **Warning!**

To reduce the risk of fire and burn injury, keep the area around the muffler clean. Remove excess lubricant and all debris such as pine needles, branches or leaves. Let the engine cool down sitting on concrete, metal, bare ground or solid wood (e.g. the trunk of a felled tree) away from any combustible substances.

 **Warning!**

Never modify your muffler. The muffler could be damaged and cause an increase in heat radiation or sparks, thereby increasing the risk of fire and burn injury. You may also permanently damage the engine. Have your muffler serviced and repaired by your STIHL servicing dealer only.

After Finishing Work

Always clean dust and dirt off the machine – do not use any grease solvents for this purpose.

Spray the blades with STIHL resin solvent. Start and run the engine briefly so that the solvent is evenly distributed.

MAINTENANCE, REPAIR AND STORING

Maintenance, replacement, or repair of the emission control devices and systems may be performed by any nonroad engine repair establishment or individual. However, if you make a warranty claim for a component which has not been serviced or maintained properly or if nonapproved replacement parts were used, STIHL may deny coverage.

Warning!

Use only identical STIHL replacement parts for maintenance and repair. Use of non-STIHL parts may cause serious or fatal injury.

Strictly follow the maintenance and repair instructions in the appropriate section of your instruction manual. Please refer to the maintenance chart in this manual.

Warning!

Always stop the engine and make sure that the cutting tool is stopped before doing any maintenance or repair work or cleaning the power tool. Do not attempt any maintenance or repair work not described in your instruction manual. Have such work performed by your STIHL servicing dealer only.

Wear gloves when handling or performing maintenance on blades.

Warning!

Use the specified spark plug and make sure it and the ignition lead are always clean and in good condition. Always press spark plug boot snugly onto spark plug terminal of the proper size. (Note: If terminal has detachable SAE adapter nut, it must be securely attached.) A loose connection between spark plug terminal and the ignition wire connector in the boot may create arcing that could ignite combustible fumes and cause a fire.

Warning!

Never test the ignition system with the ignition wire boot removed from the spark plug or with a removed spark plug, since uncontained sparking may cause a fire.

Warning!

Do not operate your power tool if the muffler is damaged, missing or modified. An improperly maintained muffler will increase the risk of fire and hearing loss. If your muffler was equipped with a spark-arresting screen to reduce the risk of fire, never operate your power tool if the screen is missing or damaged. Remember that the risk of forest fires is greater in hot or dry weather.

Warning!

Never repair damaged cutting attachments by welding, straightening or modifying the shape. This may cause parts of the cutting tool to come off and result in serious or fatal injuries.

Keep the cutting tool sharp. Tighten all nuts, bolts and screws, except the carburetor adjustment screws, after each use.

Store the power tool in a dry and high or locked location out of reach of children.

Before storing for longer than a few days, always empty the fuel tank. See chapter "Storing the machine" in this manual.

Using the Unit

HS 81 R

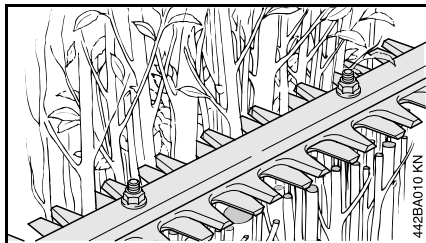

The HS 81 R is designed for cutting hedges and shrubs with thicker stems and branches.

HS 81 T

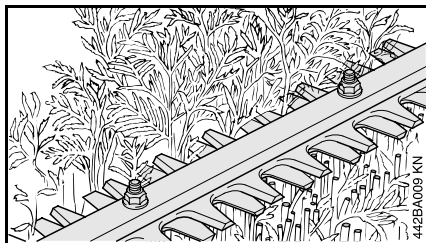

The HS 81 T is designed for shaping and trimming hedges and shrubs with thinner branches.

Use the HS 81 R hedge trimmer for cutting hedges with thicker branches.

Cutting Season

Observe country-specific or municipal rules and regulations for cutting hedges.

Do not use your power tool during other people's rest periods.

Cutting Sequence

Use lopping shears or a chain saw to cut out thick branches first.

Cut both sides of the hedge first, then the top.

Disposal

Do not throw cuttings into the garbage can – they can be composted!

Cutting Techniques

Vertical cut

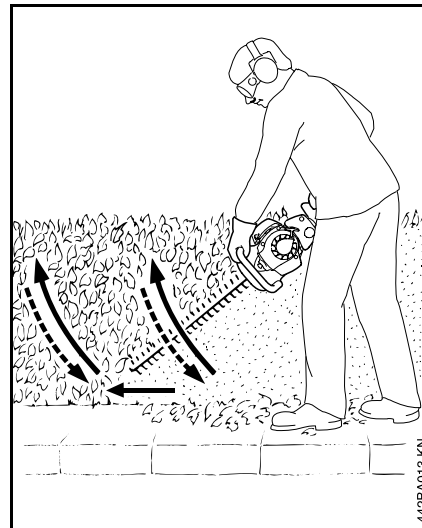

Swing the cutting blade from the bottom upwards in an arc – lower the nose of the blade, move along the hedge and then swing the blade up again in an arc.

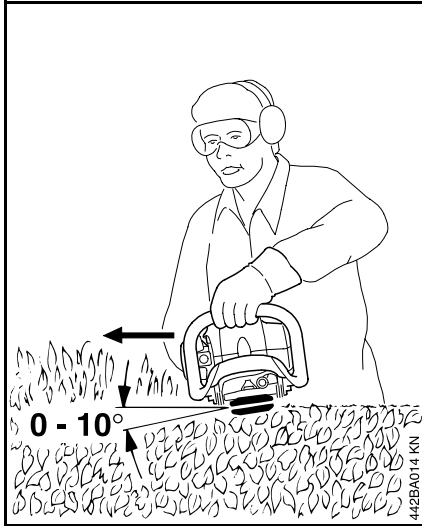
Horizontal cut

Hold the cutter bar at an angle of 0° to 10° as you swing the hedge trimmer horizontally.

Swing the cutting blade in an arc towards the outside of the hedge so that the cuttings are swept to the ground.

Maintenance and Care

The following intervals apply to normal operating conditions only. If your daily working time is longer or operating conditions are difficult (very dusty work area, etc.), shorten the specified intervals accordingly.		before starting work	after finishing work or daily	after each refueling stop	weekly	monthly	every 12 months	if problem	if damaged	if required
Complete machine	Visual inspection (condition, leaks)	X		X						
	Clean		X							
Control handle	Check operation	X		X						
Air filter (felt)	Clean							X		X
	Replace								X	
Air filter (paper)	Clean							X		X
	Replace						X		X	
Pickup body in fuel tank	Have checked by dealer ¹⁾							X		
	Have replaced by dealer ¹⁾						X		X	X
Fuel tank	Clean							X		X
Carburetor	Check idle adjustment	X		X						
	Readjust idle									X
Spark plug	Readjust electrode gap							X		
	Replace after every 100 operating hours									
Cooling inlets	Visual Inspection		X							
	Clean									X
Spark arresting screen ²⁾ in muffler	Check after every 20 hours of operation									
	Have checked by dealer ¹⁾								X	
	Have cleaned or replaced by servicing dealer ¹⁾									X
All accessible screws and nuts (not adjusting screws)	Retighten									X
Antivibration elements	Visual Inspection	X								
	Have replaced by dealer ¹⁾							X	X	

The following intervals apply to normal operating conditions only. If your daily working time is longer or operating conditions are difficult (very dusty work area, etc.), shorten the specified intervals accordingly.		before starting work	after finishing work or daily	after each refueling stop	weekly	monthly	every 12 months	if problem	if damaged	if required
Cutting blades	Clean		X							
	Sharpen									X
	Adjust blade clearance ³⁾									X
Gearbox lubrication	Check and replenish after every 25 hours of operation									
Safety labels	Replace								X	

¹⁾ STIHL recommends a STIHL servicing dealer.

²⁾ not in all versions, market-specific

³⁾ not in all versions, market-specific or available as special accessory

Main Parts

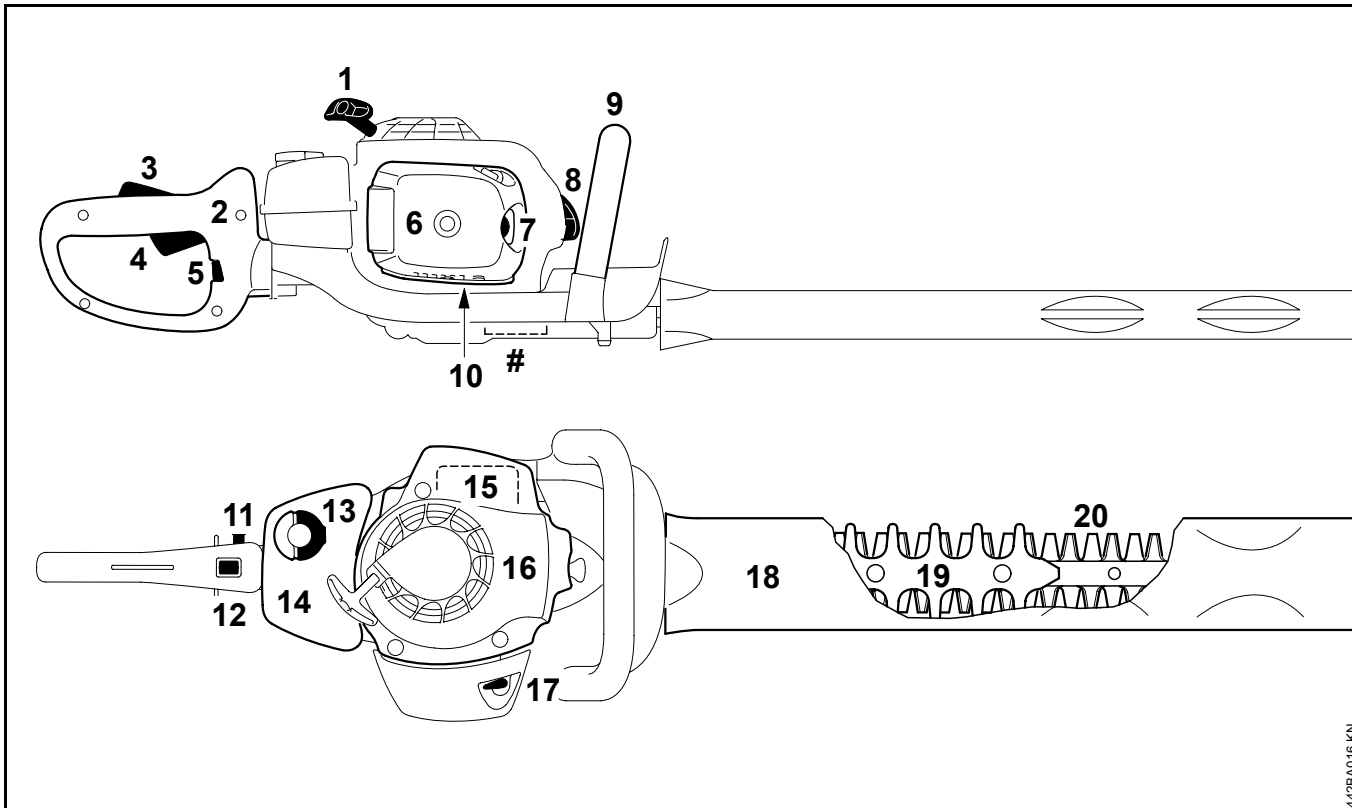

- 1 Starter Grip
- 2 Rear Handle
- 3 Throttle Trigger Lockout
- 4 Throttle Trigger
- 5 Blocking Lever
- 6 Filter Box Cover
- 7 Fuel Pump
- 8 Spark Plug Boot
- 9 Front Handle
- 10 Carburetor Adjusting Screws
- 11 Starting Throttle Lock
- 12 Stop Switch
- 13 Fuel Filler Cap
- 14 Fuel Tank
- 15 Muffler
- 16 Fan Housing
- 17 Choke Lever
- 18 Blade Scabbard
- 19 Cutting Blade Guard
- 20 Cutting Blades
- # Serial Number

Definitions

- 1. Starter Grip**
The grip of the pull starter, for starting the engine.
- 2. Rear Handle**
The support handle for the hand, located at or toward the rear of the hedge trimmer.
- 3. Throttle Trigger Lockout**
Must be depressed before the throttle trigger can be activated.
- 4. Throttle Trigger**
Controls the speed of the engine.
- 5. Blocking Lever**
Lever for rotating the rear handle.
- 6. Filter Box Cover**
Covers the air filter.
- 7. Fuel Pump**
Provides additional fuel feed for a cold start.
- 8. Spark Plug Boot**
Connects the spark plug with the ignition lead.
- 9. Front Handle**
Handle bar for the hand at front of hedge trimmer.
- 10. Carburetor Adjusting Screws**
For tuning the carburetor.
- 11. Starting Throttle Lock**
Keeps the throttle partially open during starting.
- 12. Stop Switch**
Switches the engine's ignition off and stops the engine.
- 13. Fuel Filler Cap**
For closing the fuel tank.
- 14. Fuel Tank**
For fuel and oil mixture.
- 15. Muffler**
Reduces engine exhaust noises and diverts exhaust gases away from operator.
- 16. Fan Housing**
Polymer housing which encloses the power unit.
- 17. Choke Lever**
Eases engine starting by enriching mixture.
- 18. Blade Scabbard**
Covers cutter blades when hedge trimmer is not in use.
- 19. Cutting Blade Guard**
Helps to reduce the risk of operator contact by the cutter blade.
- 20. Cutting Blades**
Steel blades for cutting hedges and shrubs.

 **WARNING!**

The engine exhaust from this product contains chemicals known to the State of California to cause cancer, birth defects or other reproductive harm.

0457-189-3021

englisch USA



www.stihl.com



0457-189-3021