



Trencher
Dingo[®] Attachment
Model No. 22447—200000001 & Up

Operator's Manual



Contents

	Page
Introduction	2
Safety	2
Safety Decals	3
Specifications	4
Stability Ratings	4
Installation	5
Loose Parts	5
Assembling the Trencher	5
Operation	6
Digging with the Trencher	6
Tips for Trenching	7
Maintenance	7
Service Interval Chart	7
Greasing and Lubrication	8
Adjusting Digging Chain Tension	8
Replacing the Digging Teeth	9
Storage	9
Reconfiguring the Digging Chain	9
List of Chain Configuration Tables	11
Troubleshooting	28

Introduction

We want you to be completely satisfied with your new product, so feel free to contact your Authorized Service Dealer for help with service, genuine replacement parts, or other information you may require.

Whenever you contact your Authorized Service Dealer or the factory, always know the model and serial numbers of your product. These numbers will help the Service Dealer or Service Representative provide exact information about your specific product. You will find the model and serial number on a plate located on the trencher safety bar. For your convenience, write the product model and serial numbers in the space below.

Model No.: _____ Serial No.: _____

The warning system in this manual identifies potential hazards and has special safety messages that help you and others avoid personal injury, even death. DANGER, WARNING and CAUTION are signal words used to identify the level of hazard. However, regardless of the hazard, be extremely careful.

DANGER signals an extreme hazard that will cause serious injury or death if the recommended precautions are not followed.

©The Toro Company—2000

8111 Lyndale Ave. South
 Bloomington, MN 55420-1196

WARNING signals a hazard that may cause serious injury or death if the recommended precautions are not followed.



CAUTION signals a hazard that may cause minor or moderate injury if the recommended precautions are not followed.



Two other words are also used to highlight information. “Important” calls attention to special mechanical information and “Note” emphasizes general information worthy of special attention.

The left and right side of the machine is determined by standing in the normal operator’s position.

Safety

Improper use or maintenance by the operator or owner can result in injury. To reduce the potential for injury, comply with these safety instructions and always pay attention to the safety alert symbol, which means CAUTION, WARNING, or DANGER—“personal safety instruction.” Failure to comply with the instruction may result in personal injury or death.

	DANGER	
<p>POTENTIAL HAZARD</p> <ul style="list-style-type: none"> There may be buried power, gas, and/or telephone lines in the work area. <p>WHAT CAN HAPPEN</p> <ul style="list-style-type: none"> Shock or explosion may occur. <p>HOW TO AVOID THE HAZARD</p> <ul style="list-style-type: none"> Have the property or work area marked for buried lines and do not dig in marked areas. 		

	DANGER	
<p>POTENTIAL HAZARD</p> <ul style="list-style-type: none"> Contact with moving teeth and auger may cause injury. <p>WHAT CAN HAPPEN</p> <ul style="list-style-type: none"> Moving teeth and auger can cut hands, feet or other body parts. <p>HOW TO AVOID THE HAZARD</p> <ul style="list-style-type: none"> Keep away from the moving teeth and auger while operating the trencher. Keep your hands, feet, and any other part of your body or clothing away from moving parts. Before adjusting, cleaning, repairing and inspecting the trencher, shut off the engine and wait for all moving parts to stop. Lower the trencher and loader arms to the ground and stop the engine. Remove the key. 		

WARNING

POTENTIAL HAZARD

- When the engine is off, attachments in the raised position can gradually lower.

WHAT CAN HAPPEN

- Someone nearby may be pinned or injured by the attachment as it lowers.

HOW TO AVOID THE HAZARD

- Always lower the attachment lift each time you shut off the traction unit.

CAUTION

POTENTIAL HAZARD

- Hydraulic couplers, hydraulic lines/valves, and hydraulic fluid may be hot.

WHAT CAN HAPPEN

- Contact with hot hydraulic components or fluid may cause burns.

HOW TO AVOID THE HAZARD

- Wear gloves when operating the hydraulic couplers.
- Allow the traction unit to cool before touching hydraulic components.
- Do not touch hydraulic fluid spills.

WARNING

POTENTIAL HAZARD

- If you do not fully seat the attachment locking pins in the attachment mount plate holes, the attachment could fall off of the traction unit.

WHAT CAN HAPPEN

- The attachment could fall rearward onto the operator, severely injuring him or her.
- Bystanders may be severely injured by the attachment as it falls.

HOW TO AVOID THE HAZARD

- Ensure that you fully seat the attachment locking pins through the holes in the attachment mount plate before lifting the attachment.
- Ensure that the attachment mount plate is free of any dirt or debris that may hinder the connection of the traction unit to the attachment.
- Refer to your traction unit *Operator's Manual* for detailed information on safely connecting an attachment to your traction unit.

Safety Decals

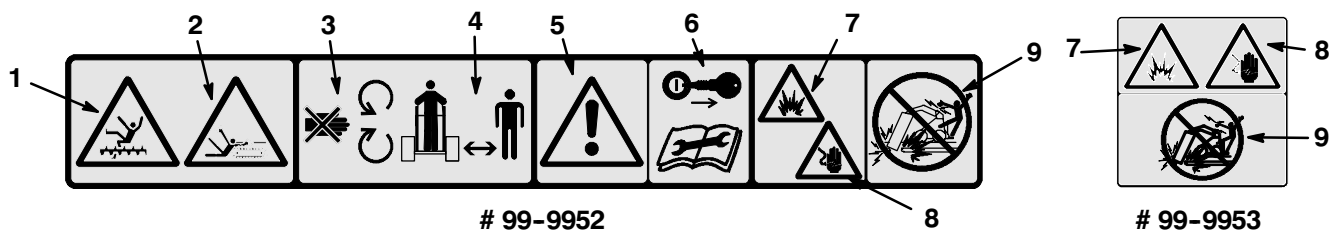

Figure 1



- | | | | |
|--------------------------------|--|---|---|
| 1. Cutting auger, keep clear | 4. Keep bystanders away from the work area | 6. Shut of engine and remove key before performing maintenance or repair work | 8. Electric shock hazard |
| 2. Cutting chain, keep clear | 5. Safety alert symbol | 7. Explosion hazard | 9. Do not dig in areas with buried gas or power lines |
| 3. Stay away from moving parts | | | |

Specifications

Width	39 inches (100 cm)
Length	65 inches (165 cm)
Height	24 inches (60 cm)
Weight (without chain)	375 lbs (170 Kg)
Drive type	Planetary gearbox
Motor displacement	5.9 in ³ /rev (102 cm ³ /rev)
Drive ratio	3.44:1
Chain speed (3600 engine rpm)	116 rpm at 11 gpm (42 Kpm)

Stability Ratings

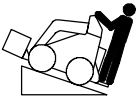
To determine the degree of slope you can traverse with the trencher installed on a traction unit, find the stability rating for the hill position you want to travel in the table below, then find the degree of slope for the same rating and hill position in the Stability Data section of the traction unit operator's manual.

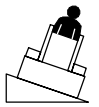
Orientation	Stability Rating
Front Uphill 	B
Rear Uphill 	C
Side Uphill 	B

⚠
WARNING
⚠

POTENTIAL HAZARD

- Exceeding the maximum slope can cause the traction unit to tip.

WHAT CAN HAPPEN

- If the traction unit tips, you or bystanders could be crushed.

HOW TO AVOID THE HAZARD

- Do not drive the traction unit on a slope steeper than the maximum slope.

IMPORTANT: If your traction unit has a rear operator's platform, the trencher is rated for use with the counterweight. Do not use it without the counterweight or the traction unit will become unstable.

Installation

Refer to your traction unit *Operator's Manual* for complete instructions on installing attachments onto the traction unit and connecting hydraulic hoses.

Loose Parts

Note: A digging chain must be purchased separately and is required for this trencher.

DESCRIPTION	QTY.	USE
Trencher boom	1	Assemble onto the trencher
Digging chain (purchased separately)	1	
Safety bar assembly	1	
Hose guide bar	1	
Bolt	4	
Washer	4	

Assembling the Trencher

Installing the Trencher Boom and Digging Chain

1. Raise the trencher about 6 inches off of the ground.
2. Stop the engine and remove the key.
3. Remove the bolt securing the spoils auger and remove the auger (Fig. 2). Save the bolt for future use.
4. Remove the wrench from the the side of the adjusting chamber (Fig. 2).

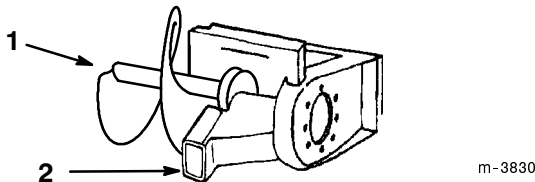
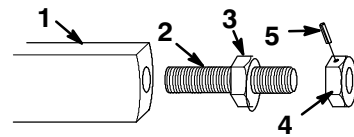

Figure 2

1. Spoils auger
2. Adjusting chamber

5. On the end of the adjuster with the flush adjustment nut (Fig. 3), make a mark across the face of the nut and adjuster. This will enable you to determine the exact position the nut should be in when you install it later.
6. Remove the roll pin from the adjustment nut, and remove the nut from the threaded adjuster (Fig. 3).
7. Thread the long end of the adjuster into the opening in the end of the trencher boom until the welded nut on the adjuster contacts the end of the boom (Fig. 3).



m-3831

Figure 3

1. Trencher boom
2. Adjuster
3. Welded nut
4. Adjustment nut
5. Roll pin

8. Insert the end of the boom into the adjusting chamber so that the adjuster slides through the small hole in the back of the adjusting chamber (Fig. 4).
9. From the back side of the adjusting chamber, thread the adjustment nut onto the adjuster until it is flush with the end of the adjuster and the mark you made across the two parts in step 5 lines up (Fig. 4).
10. Install the roll pin into the adjustment nut (Fig. 4).

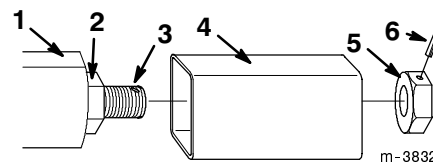

m-3832

Figure 4

1. Trencher boom
2. Welded nut
3. Adjuster
4. Adjusting chamber
5. Adjustment nut
6. Roll pin

11. If the chain is not connected, connect the links by pressing or hammering the clevis pin supplied with the chain through the links.
12. Secure the clevis pin with the cotter pin supplied with the chain.

13. Loop the digging chain over the auger drive shaft and onto the chain drive sprocket, ensuring that the digging teeth will point forward on the upper span.
14. Set the upper span of the chain into place on the trencher boom, then wrap the chain around the roller at the end of the boom.
15. Using the wrench removed in step 4, rotate the adjustment nut counter-clockwise to extend the trencher boom, tightening the chain. There should be 1 to 1-1/2 inches of slack in the chain on the top span.
16. Replace the wrench in the storage position to lock the adjustment nut in place.

Installing the Safety Bar and Hose Guide Bar

Secure the safety bar and hose guide bar to the trencher frame, using the 4 bolts and 4 washers (Fig. 5).

IMPORTANT: While installing the hose guide, route the hydraulic hoses between it and the safety bar.

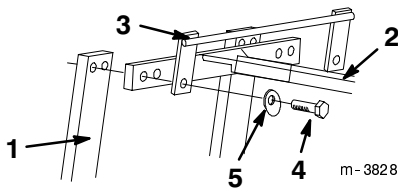

Figure 5

- | | |
|-------------------|-----------|
| 1. Trencher frame | 4. Bolt |
| 2. Safety bar | 5. Washer |
| 3. Hose guide bar | |

Installing the Spoils Auger

Before operating the trencher, install and position the spoils auger to work correctly with the digging chain configuration you are using. Failure to position the spoils auger correctly may damage the trencher.

To install and position the auger, use the bolt removed from the auger previously, to secure the auger in the correct holes, as described in the following list:

Note: Refer to Figure 6 when performing this procedure.

Note: To change the width of cut, refer to Reconfiguring the Digging Chain, page 9.

- 4" chain configuration

Using the hole closest to the auger blade in the end of the auger with two holes, connect the auger to the inner hole on the shaft.

- 6" chain configuration

Using the hole farthest from the auger blade in the end of the auger with two holes, connect the auger to the inner hole on the shaft.

- 8" chain configuration

Using the end of the auger with one hole, connect the auger to the inner hole on the shaft.

- 10 or 12" chain configuration

Using the end of the auger with one hole, connect the auger to the outer hole on the shaft.

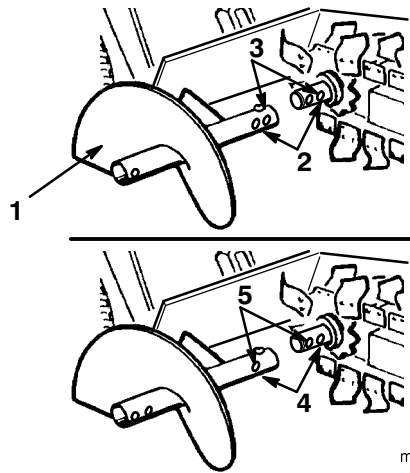

Figure 6

- | | |
|-------------------------------|---------------------------------------|
| 1. Auger | 4. Connect these holes for 8" |
| 2. Connect these holes for 4" | 5. Connect these holes for 10" or 12" |
| 3. Connect these holes for 6" | |

Operation

IMPORTANT: Always use the traction unit to lift and move the attachment.

Digging with the Trencher

1. If your traction unit has a speed selector, set it to the slow (turtle position), then start the engine.
2. Pull the auxiliary hydraulics lever to the operator grip to engage the trencher.
3. Slowly lower the trencher to the ground so that the boom and chain are parallel to the ground.

4. Begin inserting the nose of the boom and chain into the ground by slowly raising the trencher a few inches off the ground while tilting the nose down into the ground gradually.
5. Once the trencher boom is in the ground at a 45 to 60 degree angle, slowly lower the trencher until the spoils auger is just above the ground.
6. Ensure that all parts of the trencher are functioning correctly.
7. Slowly move the traction unit rearward to extend the trench.

Note: If you move too fast, the trencher will stall. If it stalls, raise it slightly, slowly drive forward, or reverse the chain direction momentarily.

8. When finished, raise the trencher and boom out of the trench by tilting the attachment rearward, then stop the trencher by moving the auxiliary hydraulics lever into neutral.

Tips for Trenching

- Clean the area of trash, branches and rocks before trenching to prevent equipment damage.
- Always begin trenching with the slowest ground speed possible. Increase speed if conditions permit.

- Always use full throttle (maximum engine speed) when trenching.
- Always trench backwards (i.e., in reverse).
- Never transport the trencher with the loader arms raised. Keep the arms lowered and the trencher tilted up.
- When trenching, the spoils auger should just clear the original ground surface to obtain maximum soil removal.
- Trench at a 45 to 60 degree angle for best results.
- You will be able to dig a trench faster by controlling the depth with periodic adjustments of the loader arms.
- If your traction unit has a speed selector, set it to the slow (turtle position).
- If your traction unit has a flow divider, adjust it to approximately the 10 o'clock position.
- If the trencher binds in the soil, push the auxiliary hydraulics lever fully forward to reverse the chain direction. Once the chain is loose, pull the lever rearward again and continue trenching.
- If you need the finished trench to be cleaner than what is possible with the trencher, you can purchase a crumber from your dealer. The crumber mounts onto the trencher and scrapes the trench clean as you run the trencher.

Maintenance

Service Interval Chart

Service Operation	Each Use	5 Hours	25 Hours	200 Hours	Storage Service	Notes
Trencher teeth—check & replace	X					as required
Spoils auger—tighten	X					as required
Planetary gear case oil—check level	Initial		X			
Digging chain—lubricate			X		X	
Digging chain tension—adjust			X		X	more often under extreme conditions (i.e., rocky, clay soil, etc. . .)
Chipped surfaces—paint					X	



CAUTION



POTENTIAL HAZARD

- If you leave the key in the ignition switch, someone could start the engine.

WHAT CAN HAPPEN

- Accidental starting of the engine could seriously injure you or other bystanders.

HOW TO AVOID THE HAZARD

- Remove the key from the ignition switch before you do any maintenance.

Greasing and Lubrication

Service Interval/Specification

Check the gear lubrication oil level in the planetary gear case before the first use, and then every 25 operating hours. Check the level sooner if you notice leaking or dampness around the gear case.

Grease lube type: SAE 90-140 API service GL-4 or GL-5

Refill capacity: 1 pint.

Checking Gear Lube

1. Position the traction unit and trencher on a level surface and lower the trencher so that the trencher is on the ground.
2. Stop the engine and remove the key.
3. Clean the area around the motor mounting flange.
4. Remove the hydraulic motor from the gear case.
Gear lube should run out.
5. Fill the gear case with enough gear lube to allow it to run out when the motor is removed, then replace the motor.

Lubricating the Digging Chain

Lubricate the digging chain after every 25 operating hours.

Lubricant Type: Commercial chain lube.

1. Lower the trencher, stop the engine, and remove the key.

2. Apply a commercial chain lube onto the upper and lower chain spans.
3. Start the engine, raise the trencher slightly off the ground using the loader arms, and slowly run the chain forward to expose the un-lubed upper and lower chain spans.
4. Lower the trencher, stop the engine, and remove the key.
5. Apply lube to the newly exposed, un-lubed chain spans.
6. Start the engine and slowly run the chain forward to work the lubrication into the chain.
7. Stop the engine and remove the key.

Adjusting Digging Chain Tension

Adjust the digging chain every 25 operating hours. With the trencher parallel to the ground, ensure that there are 3 inches between the bottom of the boom and the top of the bottom chain span. If there is more than 3 inches, adjust the chain using the following procedure:

IMPORTANT: Do not over tighten the chain. Excess chain tension may damage drive components.

1. Lower the trencher, stop the engine, and remove the key.
2. Remove the wrench from the the side of the trencher.

Note: The butt of the wrench locks the adjustment nut.

3. Using the wrench, rotate the adjustment nut counter-clockwise to extend the trencher boom to tighten the chain.

4. Replace the wrench in the storage position to lock the adjustment nut in place.

Replacing the Digging Teeth

Due to the high amount of wear placed on the digging teeth, you will need to replace them periodically.

To replace a single tooth, remove the bolts securing the tooth to remove it, then install a new tooth in the same position. Torque the bolts securing the teeth to 27–33 ft. lbs. (37–45 Nm).

Storage

1. Before long term storage, brush the dirt from the attachment. Do not wash it, because washing will cause rust.
2. Check the condition of the digging chain. Adjust and lubricate the chain. Replace any worn or damaged teeth.
3. Check gear case lubrication.
4. Check and tighten all bolts, nuts, and screws. Repair or replace any part that is damaged or worn.
5. Ensure that all hydraulic couplers are connected together to prevent contamination of the hydraulic system.
6. Paint all scratched or bare metal surfaces. Paint is available from your Authorized Service Dealer.
7. Store the trencher in a clean, dry garage or storage area. Cover the trencher to protect it and keep it clean.

Reconfiguring the Digging Chain

The chain can be set up in different configurations, depending on the width of the trench desired and the soil conditions at the work site. Each chain has 32 links; however, depending on the type of chain you purchased, either all 32 or 16 of these links can have teeth fastened to them. In this section, a link that can have teeth fastened to it is referred to as a tooth position. At each tooth position, the teeth are fastened in various configurations with spacers and tubes to vary the width of cut. The tooth configurations are placed along the chain in an order that maximizes digging efficiency.

There are two types of teeth, cupped and triangular rock teeth. Cupped teeth are designed to cut through and remove soil. Triangular rock teeth cut rock and other hard ground. The teeth are cupped or angled differently depending on which side of the chain they are intended to be fastened (i.e., either left or right).

The teeth are fastened to the chain links using bolts, nuts, tubes, and spacers of varying sizes. Figure 7 illustrates the various components of several tooth configurations. The tables on the pages following Figure 7 illustrate the possible chain configurations, detailing which tooth configuration should be installed at each tooth position around the chain for each chain configuration.

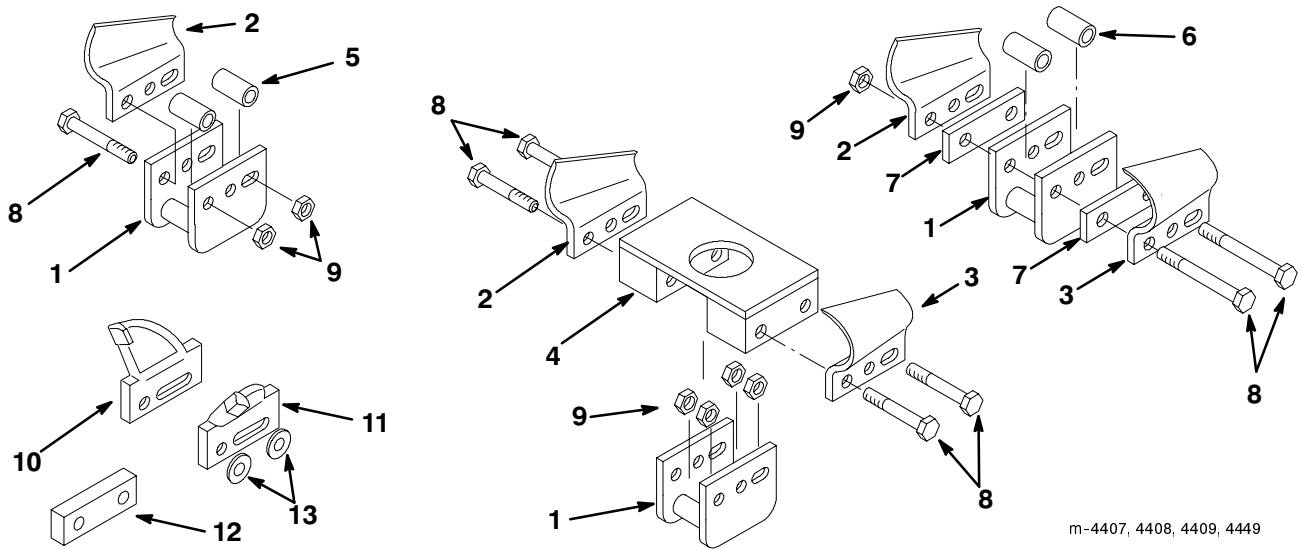

m-4407, 4408, 4409, 4449

Figure 7

- | | | | |
|---|--|---------------------------------|--|
| 1. Chain link | 5. Short tube | 8. Bolt | 12. Spacer for 6", triangular rock tooth configuration |
| 2. Left, cupped tooth | 6. Long tube | 9. Nut | 13. Washer (for use with triangular rock teeth only) |
| 3. Right, cupped tooth | 7. Spacer for 6", double cupped configuration. | 10. Left triangular rock tooth | |
| 4. Large spacer (comes in 3 sizes for 8", 10", and 12" cutting width) | | 11. Right triangular rock tooth | |

To reconfigure the chain, complete the following procedure:

1. Select the chain configuration you want to install from the chain configuration tables contained on the following pages and obtain all necessary parts.
2. Lower the loader arms, stop the engine, and remove the key.
3. Remove the unneeded teeth and other hardware from the links on the top span of the chain.

Note: When removing teeth, keep the components of each tooth set together so you can assemble them later.

4. Install each tooth set across the top span from front to back, in the order listed in the appropriate chain configuration table.

Note: Install the tooth configuration illustrated for tooth position 1 first, followed by the configuration for tooth position 2, and so on.

5. Torque the bolts to 27–33 ft. lbs. (37–45 Nm).
6. When all positions are installed on the top span, start the engine, raise the trencher slightly off the ground using the loader arms, and slowly run the chain forward to expose a new section of chain.
7. Stop the engine and remove the key.
8. Repeat steps 3 through 7 until all chain positions have been changed.

List of Chain Configuration Tables

Chain Type	Soil Type	Trench Width	Page
16 position	Typical	4"	11
		6"	12
		8"	12
		10"	13
		12"	13
32 position	Typical	4"	14
		6"	15
		8"	16
		10"	17
		12"	18

Chain Type	Soil Type	Trench Width	Page
32 position	Sand or Loose	4"	19
		6"	20
		8"	21
		10"	22
		12"	23
	Hard or Rocky	4"	24
		6"	25
	Rock	4"	26
		6"	27

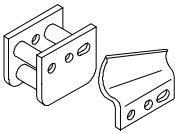
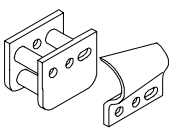
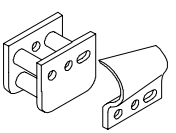
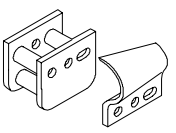
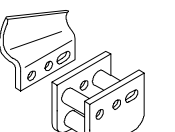
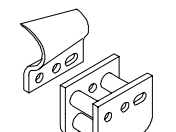
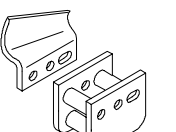
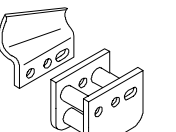
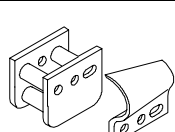
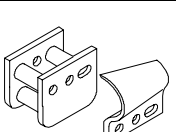
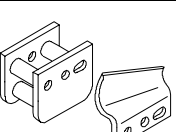
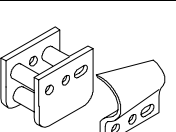
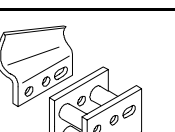
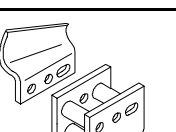
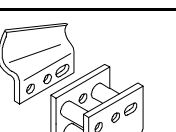
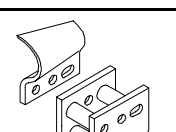
Typical Soil 4" Trench, 16 Position Chain			
Tooth Position and Configuration	Tooth Position and Configuration	Tooth Position and Configuration	Tooth Position and Configuration
1 	5 	9 	13 
2 	6 	10 	14 
3 	7 	11 	15 
4 	8 	12 	16 

**Typical Soil
6" Trench, 16 Position Chain**

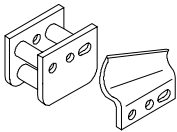
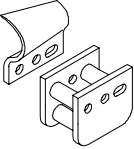
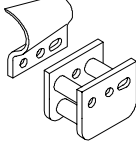
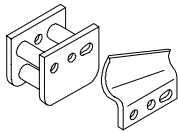
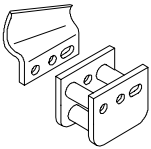
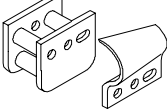
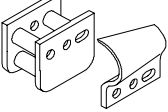
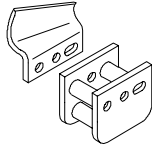
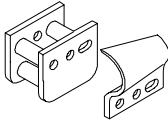
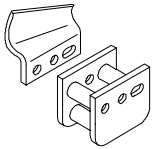
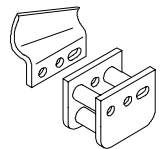
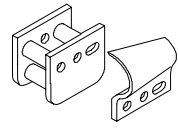
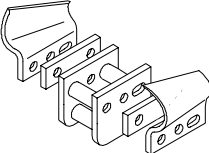
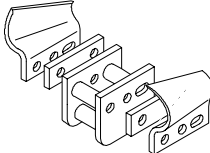
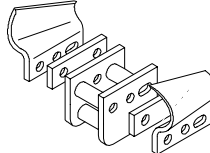
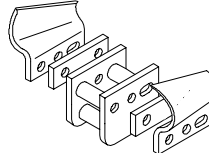
Tooth Position and Configuration	Tooth Position and Configuration	Tooth Position and Configuration	Tooth Position and Configuration
1 	5 	9 	13 
2 	6 	10 	14 
3 	7 	11 	15 
4  6" double cupped	8  6" double cupped	12  6" double cupped	16  6" double cupped

**Typical Soil
8" Trench, 16 Position Chain**

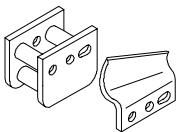
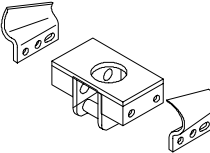
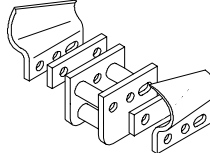
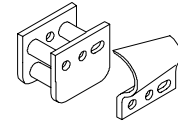
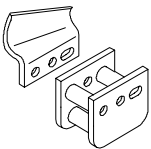
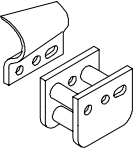
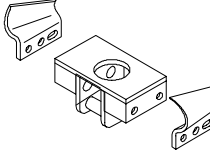
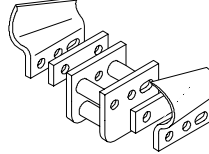
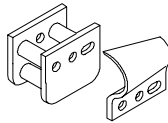
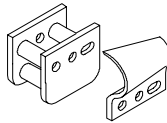
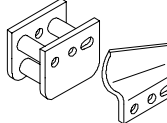
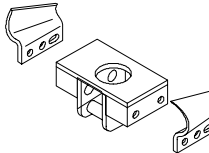
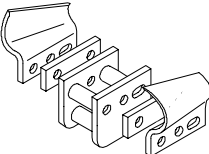
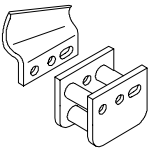
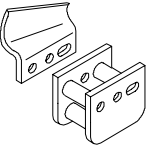
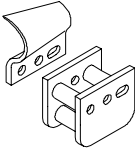
Tooth Position and Configuration	Tooth Position and Configuration	Tooth Position and Configuration	Tooth Position and Configuration
1 	5  8" double cupped	9  6" double cupped	13 
2 	6 	10  8" double cupped	14  6" double cupped
3 	7 	11 	15  8" double cupped
4  6" double cupped	8 	12 	16 

**Typical Soil
10" Trench, 16 Position Chain**

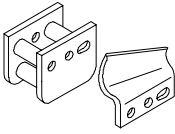
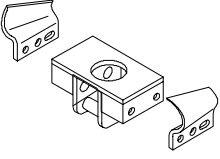
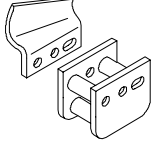
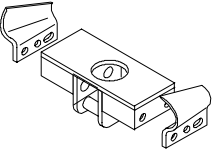
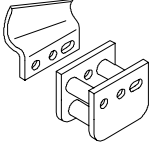
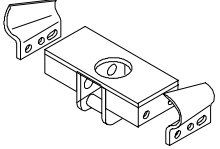
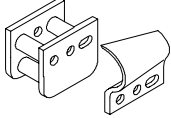
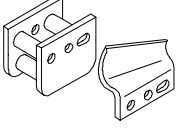
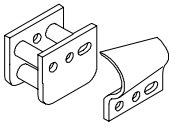
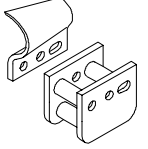
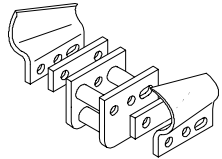
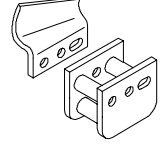
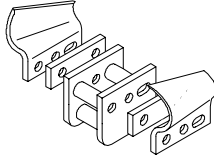
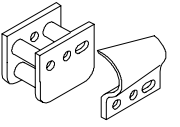
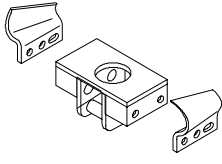
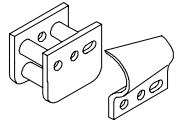
Tooth Position and Configuration	Tooth Position and Configuration	Tooth Position and Configuration	Tooth Position and Configuration
1 	5  8" double cupped	9 	13  10" double cupped
2 	6  10" double cupped	10 	14 
3 	7 	11  6" double cupped	15 
4  6" double cupped	8 	12  8" double cupped	16 

**Typical Soil
12" Trench, 16 Position Chain**

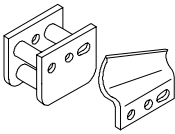
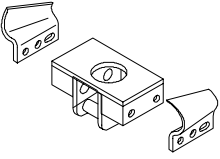
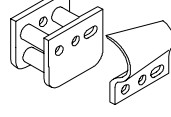
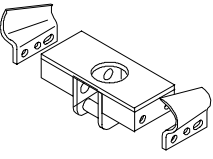
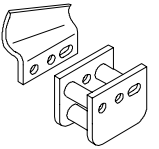
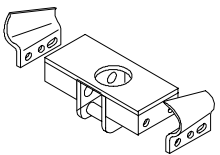
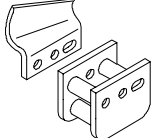
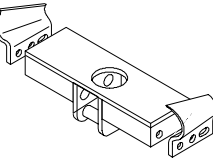
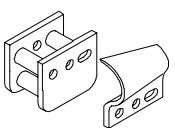
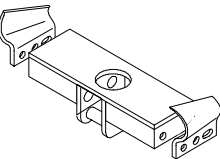
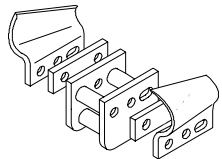
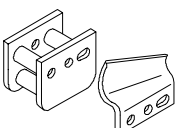
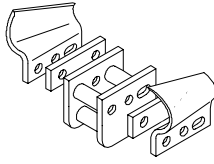
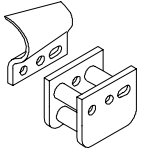
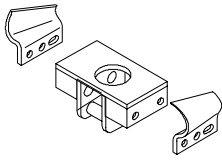
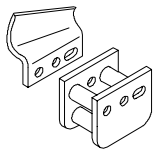
Tooth Position and Configuration	Tooth Position and Configuration	Tooth Position and Configuration	Tooth Position and Configuration
1 	5  8" double cupped	9 	13  10" double cupped
2 	6  10" double cupped	10 	14  12" double cupped
3 	7  12" double cupped	11  6" double cupped	15 
4  6" double cupped	8 	12  8" double cupped	16 

**Typical Soil
4" Trench, 32 Position Chain**

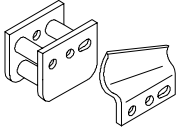
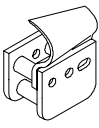
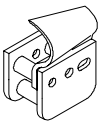
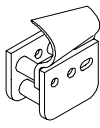
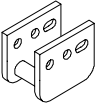
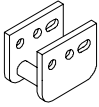
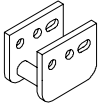
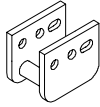
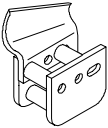
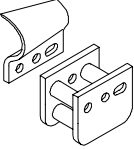
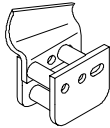
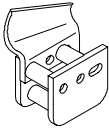
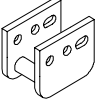
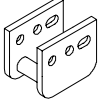
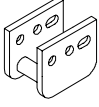
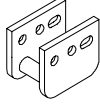
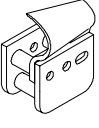
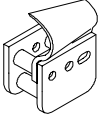
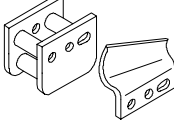
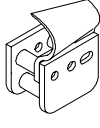
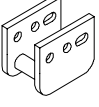
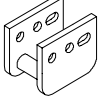
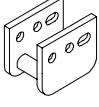
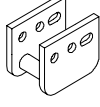
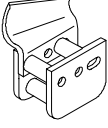
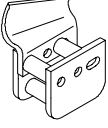
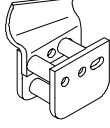
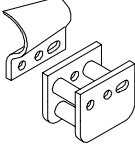
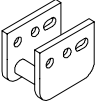
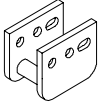
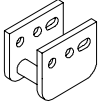
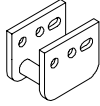
Tooth Position and Configuration	Tooth Position and Configuration	Tooth Position and Configuration	Tooth Position and Configuration
1 	9 	17 	25 
2 	10 	18 	26 
3 	11 	19 	27 
4 	12 	20 	28 
5 	13 	21 	29 
6 	14 	22 	30 
7 	15 	23 	31 
8 	16 	24 	32 

**Typical Soil
6" Trench, 32 Position Chain**

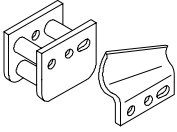
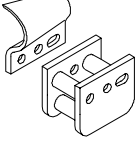
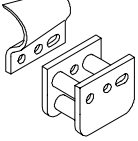
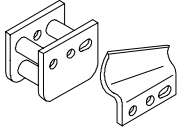
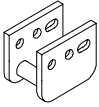
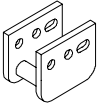
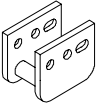
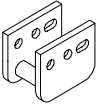
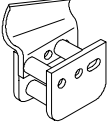
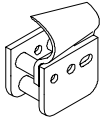
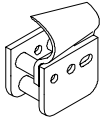
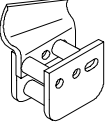
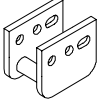
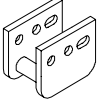
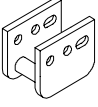
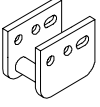
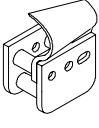
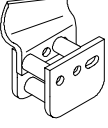
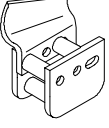
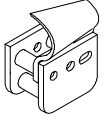
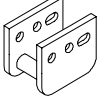
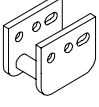
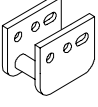
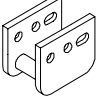
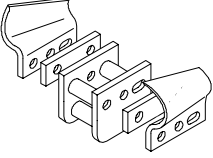
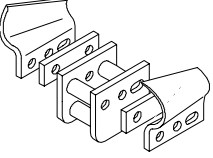
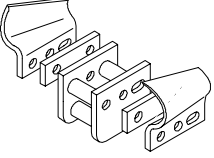
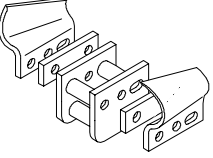
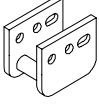
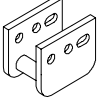
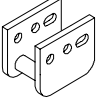
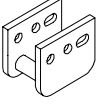
Tooth Position and Configuration	Tooth Position and Configuration	Tooth Position and Configuration	Tooth Position and Configuration
1 	9 	17 	25 
2 	10 	18 	26 
3 	11 	19 	27 
4 	12 	20 	28 
5 	13 	21 	29 
6 	14 	22 	30 
7  6" double cupped	15  6" double cupped	23  6" double cupped	31  6" double cupped
8 	16 	24 	32 

**Typical Soil
8" Trench, 32 Position Chain**

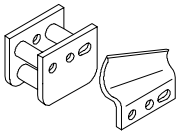
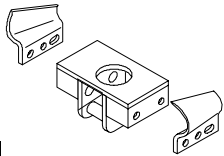
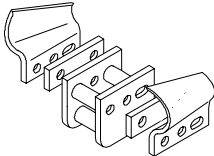
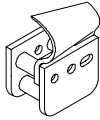
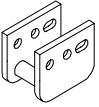
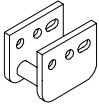
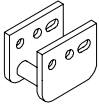
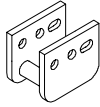
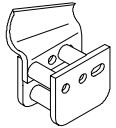
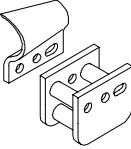
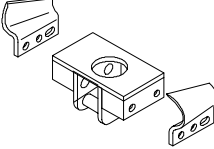
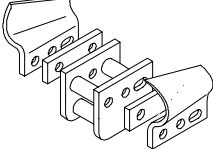
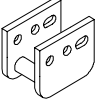
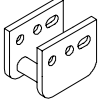
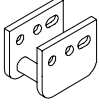
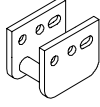
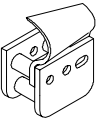
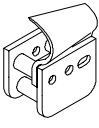
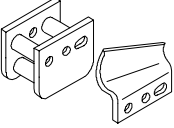
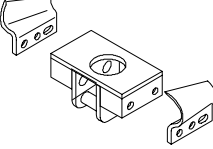
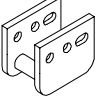
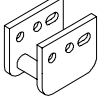
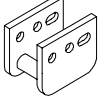
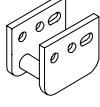
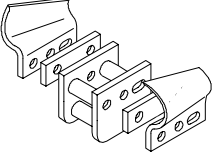
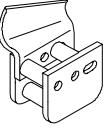
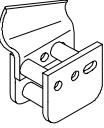
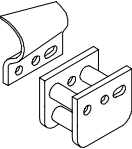
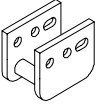
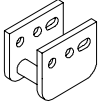
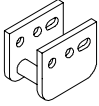
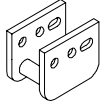
Tooth Position and Configuration	Tooth Position and Configuration	Tooth Position and Configuration	Tooth Position and Configuration
1 	9  8" double cupped	17  6" double cupped	25 
2 	10 	18 	26 
3 	11 	19  8" double cupped	27  6" double cupped
4 	12 	20 	28 
5 	13 	21 	29  8" double cupped
6 	14 	22 	30 
7  6" double cupped	15 	23 	31 
8 	16 	24 	32 

**Typical Soil
10" Trench, 32 Position Chain**

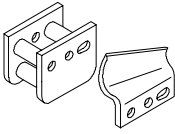
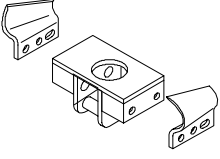
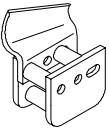
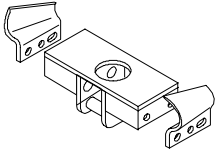
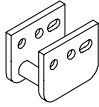
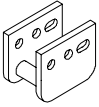
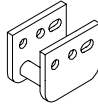
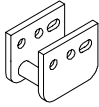
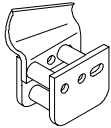
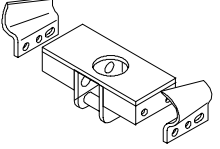
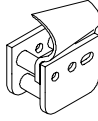
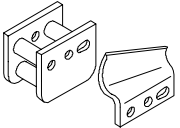
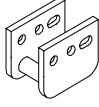
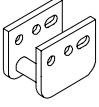
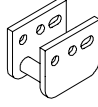
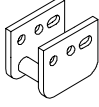
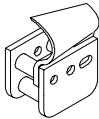
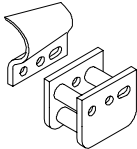
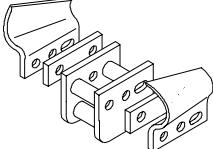
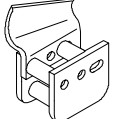
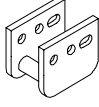
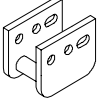
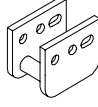
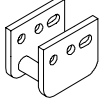
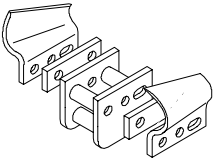
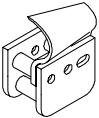
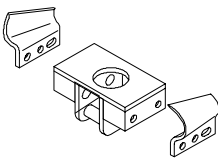
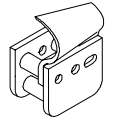
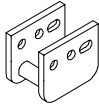
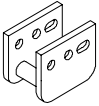
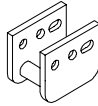
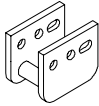
Tooth Position and Configuration	Tooth Position and Configuration	Tooth Position and Configuration	Tooth Position and Configuration
<p>1</p> 	<p>9</p> <p>8" double cupped</p> 	<p>17</p> 	<p>25</p> <p>10" double cupped</p> 
<p>2</p> 	<p>10</p> 	<p>18</p> 	<p>26</p> 
<p>3</p> 	<p>11</p> <p>10" double cupped</p> 	<p>19</p> 	<p>27</p> 
<p>4</p> 	<p>12</p> 	<p>20</p> 	<p>28</p> 
<p>5</p> 	<p>13</p> 	<p>21</p> <p>6" double cupped</p> 	<p>29</p> 
<p>6</p> 	<p>14</p> 	<p>22</p> 	<p>30</p> 
<p>7</p> <p>6" double cupped</p> 	<p>15</p> 	<p>23</p> <p>8" double cupped</p> 	<p>31</p> 
<p>8</p> 	<p>16</p> 	<p>24</p> 	<p>32</p> 

**Typical Soil
12" Trench, 32 Position Chain**

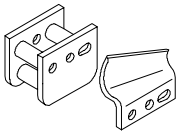
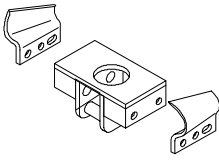
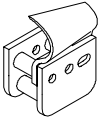
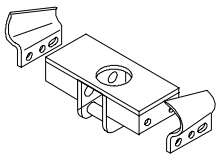
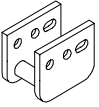
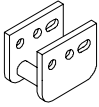
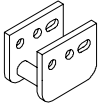
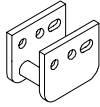
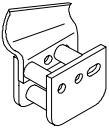
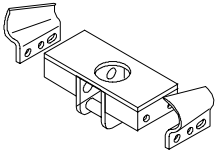
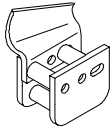
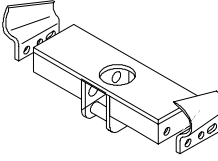
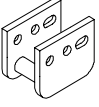
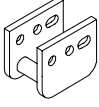
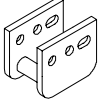
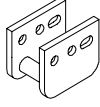
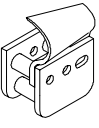
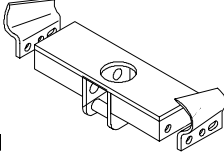
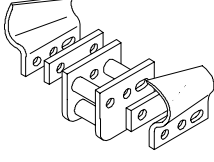
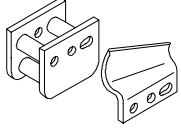
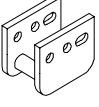
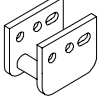
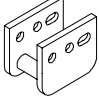
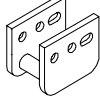
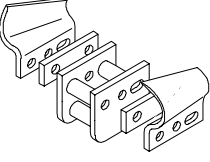
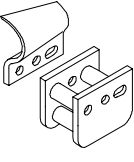
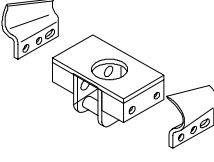
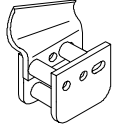
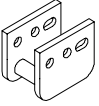
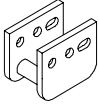
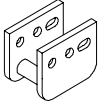
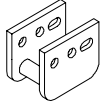
Tooth Position and Configuration	Tooth Position and Configuration	Tooth Position and Configuration	Tooth Position and Configuration
<p>1</p> 	<p>9</p> <p>8" double cupped</p> 	<p>17</p> 	<p>25</p> <p>10" double cupped</p> 
<p>2</p> 	<p>10</p> 	<p>18</p> 	<p>26</p> 
<p>3</p> 	<p>11</p> <p>10" double cupped</p> 	<p>19</p> 	<p>27</p> <p>12" double cupped</p> 
<p>4</p> 	<p>12</p> 	<p>20</p> 	<p>28</p> 
<p>5</p> 	<p>13</p> <p>12" double cupped</p> 	<p>21</p> <p>6" double cupped</p> 	<p>29</p> 
<p>6</p> 	<p>14</p> 	<p>22</p> 	<p>30</p> 
<p>7</p> <p>6" double cupped</p> 	<p>15</p> 	<p>23</p> <p>8" double cupped</p> 	<p>31</p> 
<p>8</p> 	<p>16</p> 	<p>24</p> 	<p>32</p> 

**Sand and Loose Soil
4" Trench, 32 Position Chain**

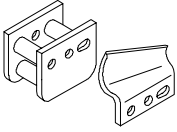
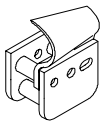
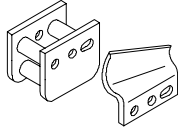
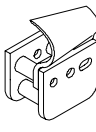
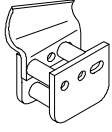
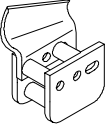
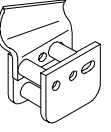
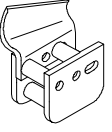
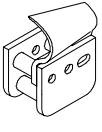
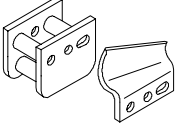
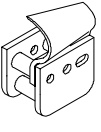
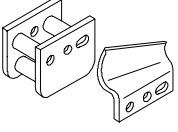
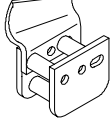
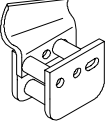
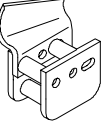
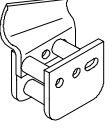
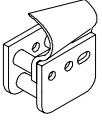
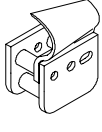
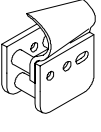
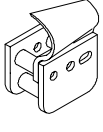
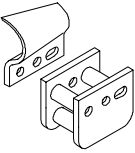
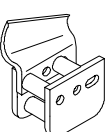
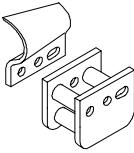
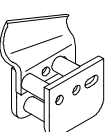
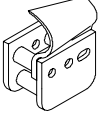
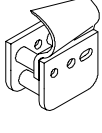
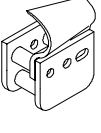
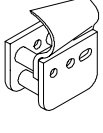
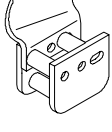
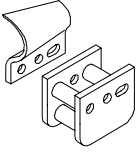
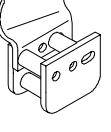
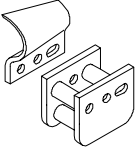
Tooth Position and Configuration	Tooth Position and Configuration	Tooth Position and Configuration	Tooth Position and Configuration
1 	9 	17 	25 
2 	10 	18 	26 
3 	11 	19 	27 
4 	12 	20 	28 
5 	13 	21 	29 
6 	14 	22 	30 
7 	15 	23 	31 
8 	16 	24 	32 

**Sand and Loose Soil
6" Trench, 32 Position Chain**

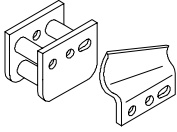
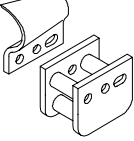
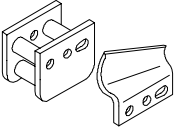
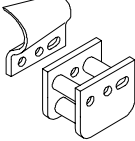
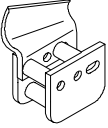
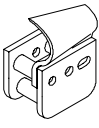
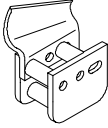
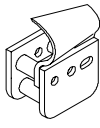
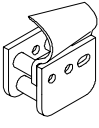
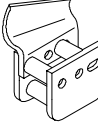
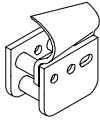
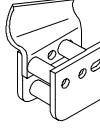
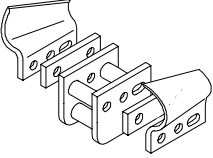
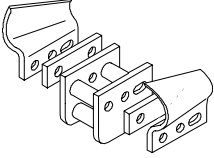
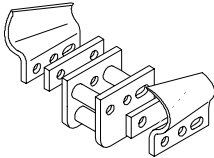
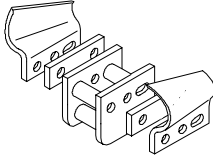
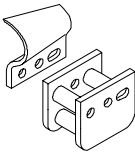
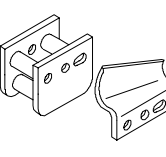
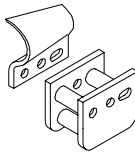
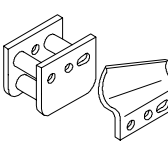
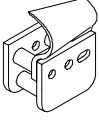
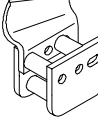
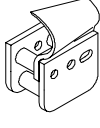
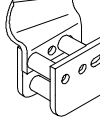
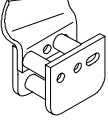
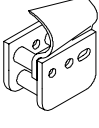
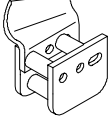
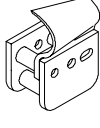
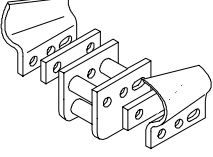
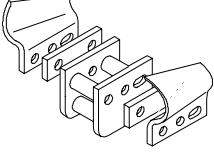
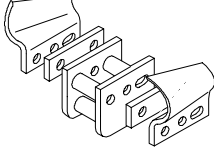
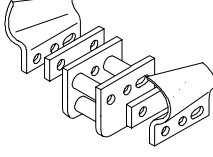
Tooth Position and Configuration	Tooth Position and Configuration	Tooth Position and Configuration	Tooth Position and Configuration
1 	9 	17 	25 
2 	10 	18 	26 
3 	11 	19 	27 
4  6" double cupped	12  6" double cupped	20  6" double cupped	28  6" double cupped
5 	13 	21 	29 
6 	14 	22 	30 
7 	15 	23 	31 
8  6" double cupped	16  6" double cupped	24  6" double cupped	32  6" double cupped

**Sand and Loose Soil
8" Trench, 32 Position Chain**

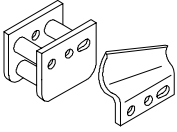
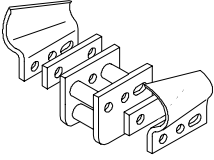
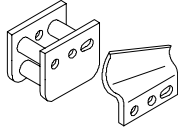
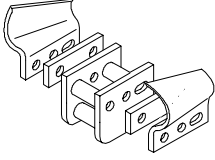
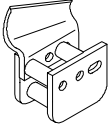
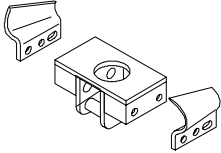
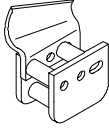
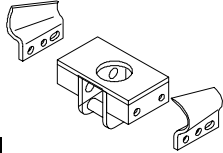
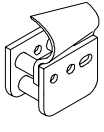
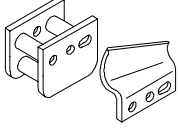
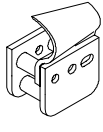
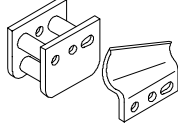
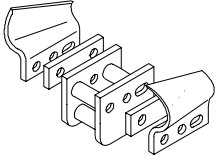
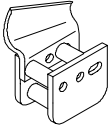
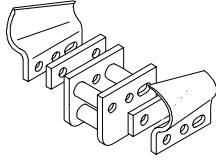
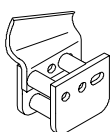
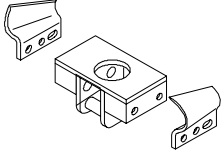
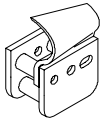
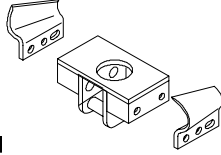
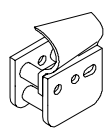
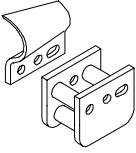
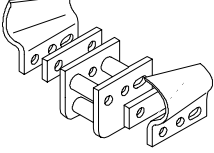
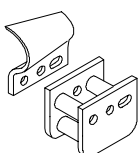
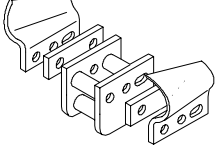
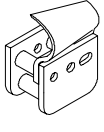
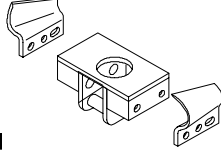
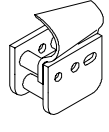
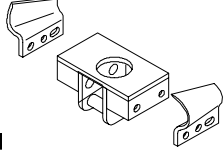
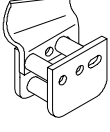
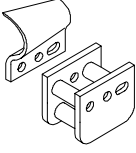
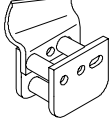
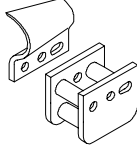
Tooth Position and Configuration	Tooth Position and Configuration	Tooth Position and Configuration	Tooth Position and Configuration
1 	9  6" double cupped	17 	25  6" double cupped
2 	10  8" double cupped	18 	26  8" double cupped
3 	11 	19 	27 
4  6" double cupped	12 	20  6" double cupped	28 
5  8" double cupped	13 	21  8" double cupped	29 
6 	14  6" double cupped	22 	30  6" double cupped
7 	15  8" double cupped	23 	31  8" double cupped
8 	16 	24 	32 

**Sand and Loose Soil
10" Trench, 32 Position Chain**

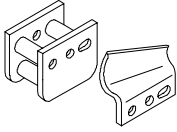
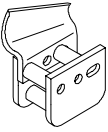
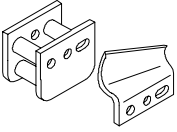
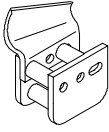
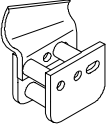
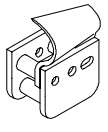
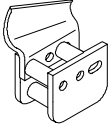
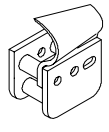
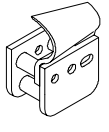
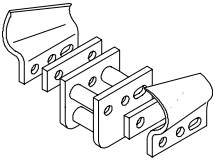
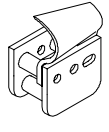
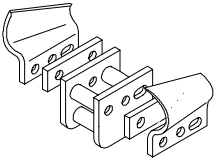
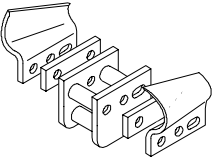
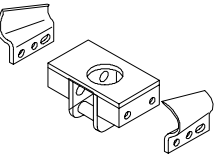
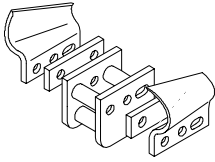
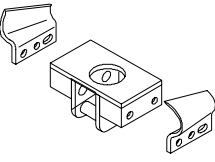
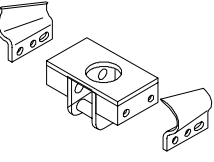
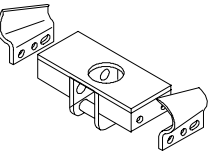
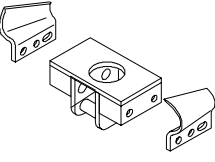
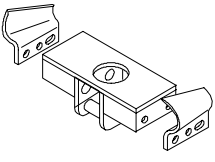
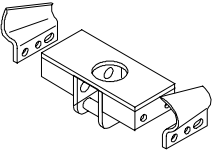
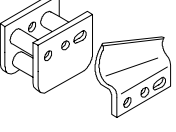
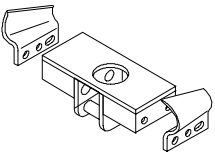
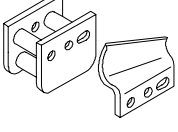
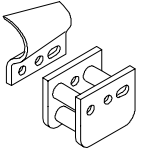
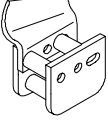
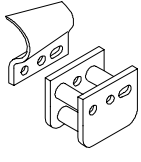
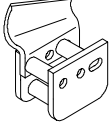
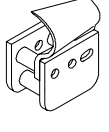
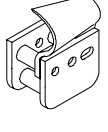
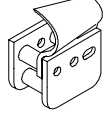
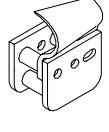
Tooth Position and Configuration	Tooth Position and Configuration	Tooth Position and Configuration	Tooth Position and Configuration
1 	9 	17 	25 
2 	10 	18 	26 
3 	11 6" double cupped 	19 	27 6" double cupped 
4 6" double cupped 	12 8" double cupped 	20 6" double cupped 	28 8" double cupped 
5 8" double cupped 	13 10" double cupped 	21 8" double cupped 	29 10" double cupped 
6 10" double cupped 	14 	22 10" double cupped 	30 
7 	15 	23 	31 
8 	16 	24 	32 

**Sand and Loose Soil
12" Trench, 32 Position Chain**

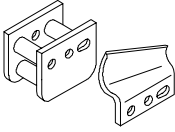
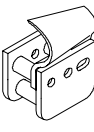
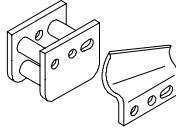
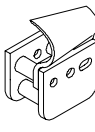
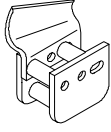
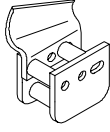
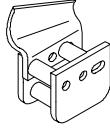
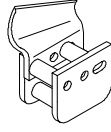
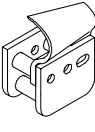
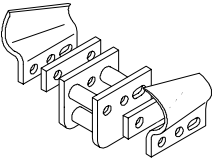
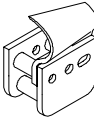
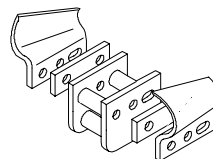
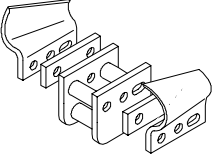
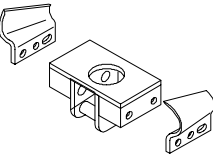
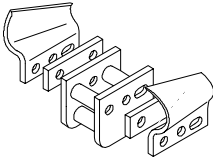
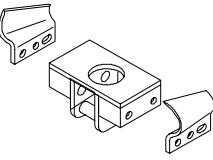
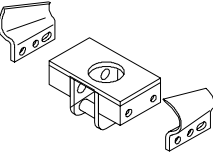
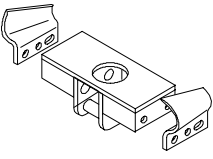
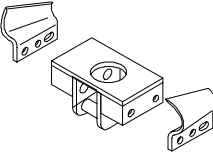
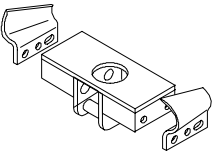
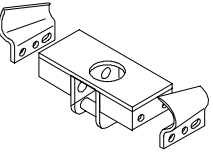
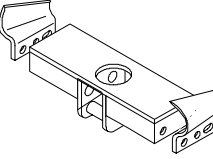
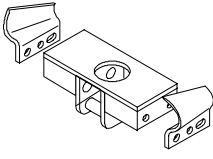
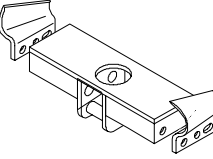
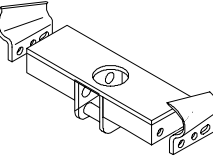
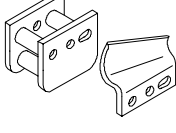
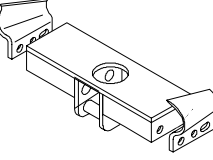
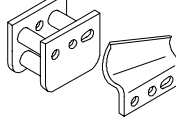
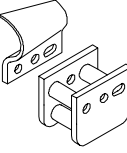
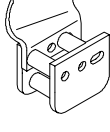
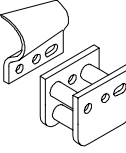
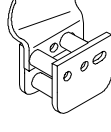
Tooth Position and Configuration	Tooth Position and Configuration	Tooth Position and Configuration	Tooth Position and Configuration
1 	9 	17 	25 
2 	10 	18 	26 
3 	11 6" double cupped 	19 	27 6" double cupped 
4 6" double cupped 	12 8" double cupped 	20 6" double cupped 	28 8" double cupped 
5 8" double cupped 	13 10" double cupped 	21 8" double cupped 	29 10" double cupped 
6 10" double cupped 	14 12" double cupped 	22 10" double cupped 	30 12" double cupped 
7 12" double cupped 	15 	23 12" double cupped 	31 
8 	16 	24 	32 

**Hard or Rocky Ground
4" Trench, 32 Position Chain**

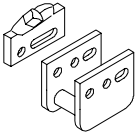
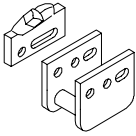
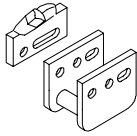
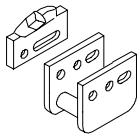
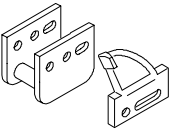
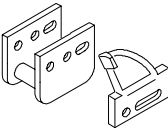
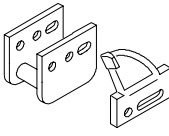
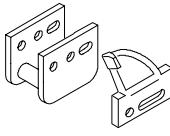
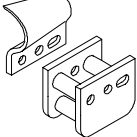
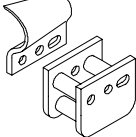
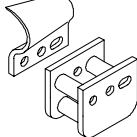
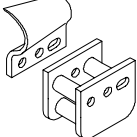
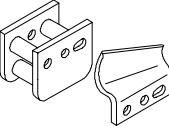
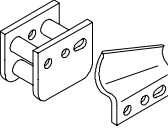
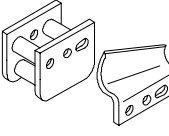
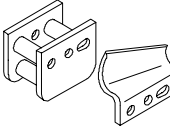
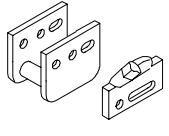
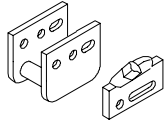
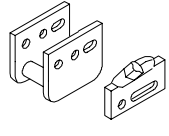
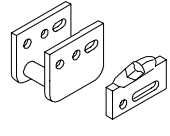
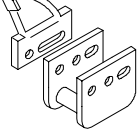
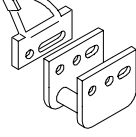
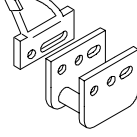
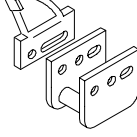
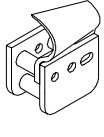
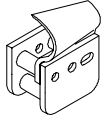
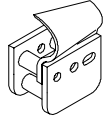
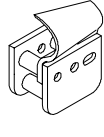
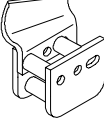
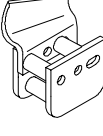
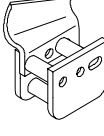
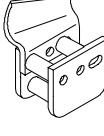
Tooth Position and Configuration	Tooth Position and Configuration	Tooth Position and Configuration	Tooth Position and Configuration
1 	9 	17 	25 
2 	10 	18 	26 
3 	11 	19 	27 
4 	12 	20 	28 
5 	13 	21 	29 
6 	14 	22 	30 
7 	15 	23 	31 
8 	16 	24 	32 

**Hard or Rocky Ground
6" Trench, 32 Position Chain**

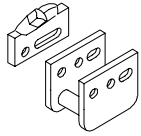
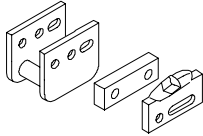
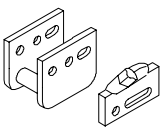
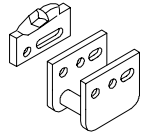
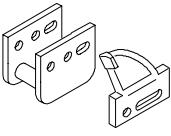
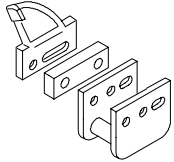
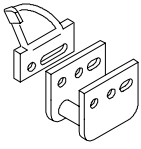
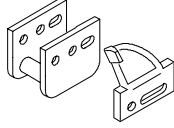
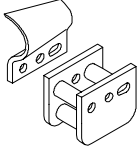
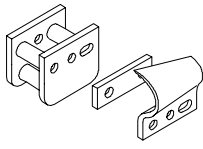
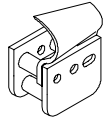
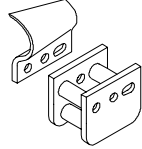
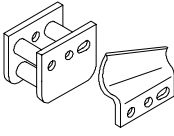
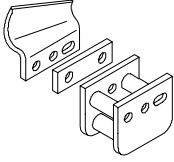
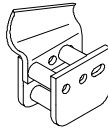
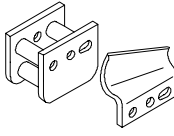
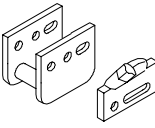
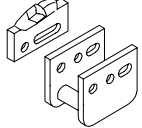
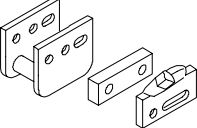
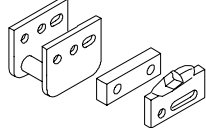
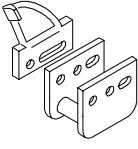
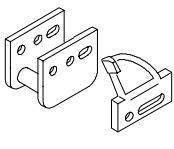
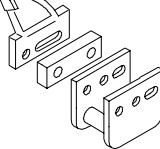
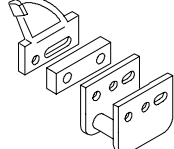
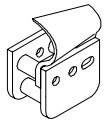
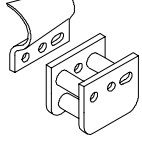
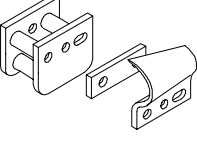
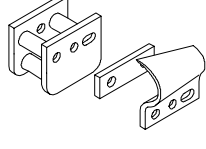
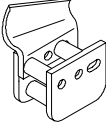
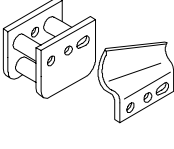
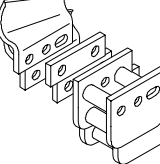
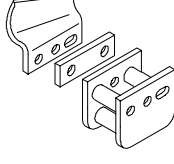
Tooth Position and Configuration	Tooth Position and Configuration	Tooth Position and Configuration	Tooth Position and Configuration
1 	9 	17 	25 
2 	10 	18 	26 
3 	11 	19 	27 
4 	12 	20 	28 
5 	13 	21 	29 
6 	14 	22 	30 
7 	15 	23 	31 
8 	16 	24 	32 

**Rock
4" Trench, 32 Position Chain**

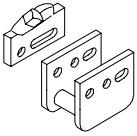
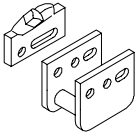
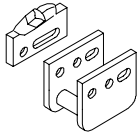
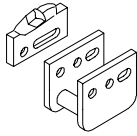
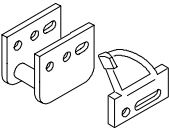
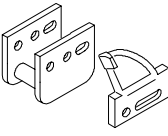
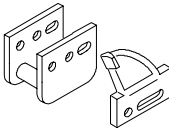
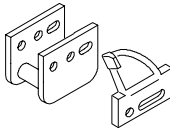
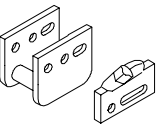
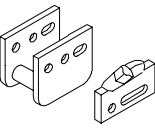
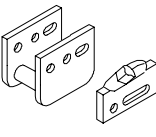
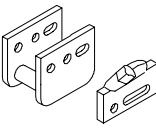
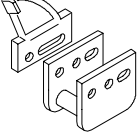
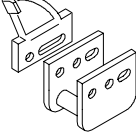
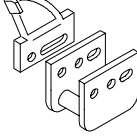
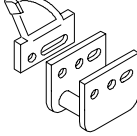
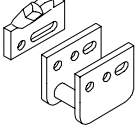
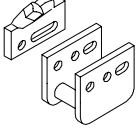
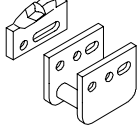
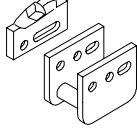
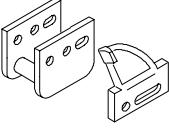
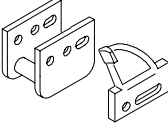
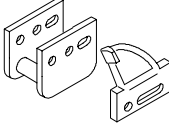
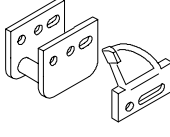
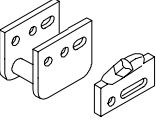
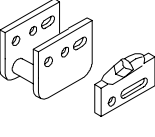
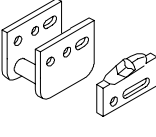
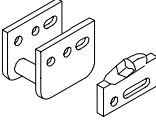
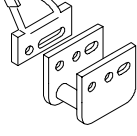
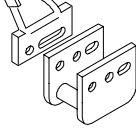
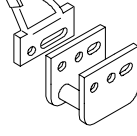
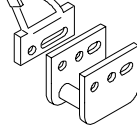

Tooth Position and Configuration	Tooth Position and Configuration	Tooth Position and Configuration	Tooth Position and Configuration
1 	9 	17 	25 
2 	10 	18 	26 
3 	11 	19 	27 
4 	12 	20 	28 
5 	13 	21 	29 
6 	14 	22 	30 
7 	15 	23 	31 
8 	16 	24 	32 

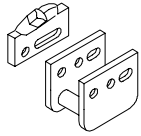
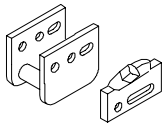
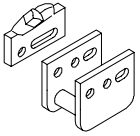
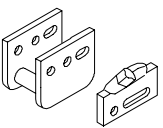
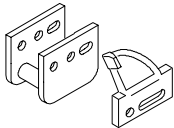
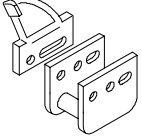
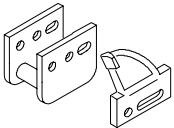
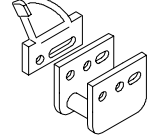
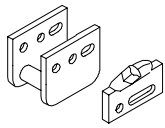
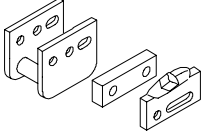
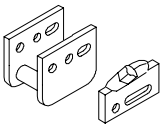
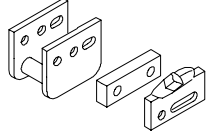
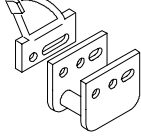
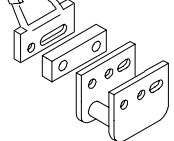
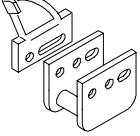
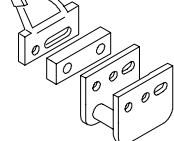
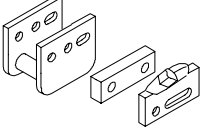
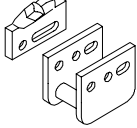
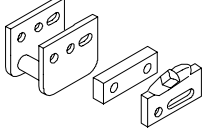
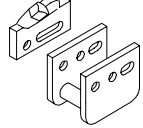
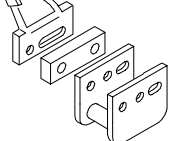
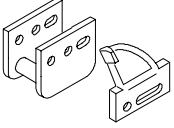
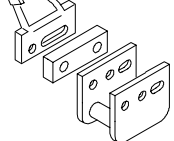
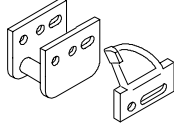
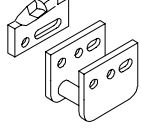
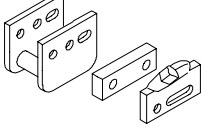
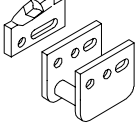
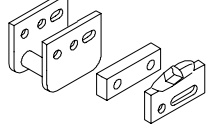
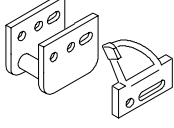
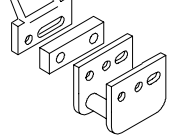
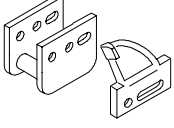
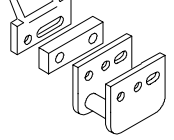
**Rock
6" Trench, 32 Position Chain**

Tooth Position and Configuration	Tooth Position and Configuration	Tooth Position and Configuration	Tooth Position and Configuration
1 	9 	17 	25 
2 	10 	18 	26 
3 	11 	19 	27 
4 	12 	20 	28 
5 	13 	21 	29 
6 	14 	22 	30 
7 	15 	23 	31 
8 	16 	24 	32 

Troubleshooting

PROBLEM	POSSIBLE CAUSES	CORRECTIVE ACTION
Chain does not turn.	<ol style="list-style-type: none"> 1. Hydraulic coupler not completely connected 2. Damaged hydraulic coupler 3. An obstruction in a hydraulic hose 4. Auxiliary valve on the traction unit is not opening. 5. Trencher boom end bearing failed 6. Digging chain too tight 7. Sand buildup in tooth root of sprocket 8. Hydraulic motor failure 9. Chain drive failure 	<ol style="list-style-type: none"> 1. Check and tighten all couplers. 2. Check/replace couplers 3. Find and remove the obstruction. 4. Repair the valve. 5. Replace the bearing. 6. Adjust the digging chain. 7. Raise trencher and run the chain backwards, then reduce the chain tension. 8. Contact Authorized Service Dealer. 9. Contact Authorized Service Dealer.
Does not dig fast enough.	<ol style="list-style-type: none"> 1. Worn teeth 2. Wrong setting on flow divider and speed lever 3. Quick coupler or hose restriction 4. Hydraulic system too hot 5. Relief valve set below specifications 	<ol style="list-style-type: none"> 1. Replace any worn teeth. 2. Set the flow divider to the 10:00 position and the speed lever to the "turtle" position. 3. Check hoses and couplers and repair any problems found. 4. Shutdown and allow the system to cool. 5. Contact Authorized Service Dealer.
Chain turns in the wrong direction	<ol style="list-style-type: none"> 1. Auxiliary valve lever in wrong position 2. Hydraulic hoses reversed 	<ol style="list-style-type: none"> 1. Move auxiliary valve lever to the rearward position. 2. Disconnect hoses and switch positions.

 WARNING 
<p>POTENTIAL HAZARD</p> <ul style="list-style-type: none"> • Hydraulic fluid escaping under pressure can penetrate skin and cause injury. <p>WHAT CAN HAPPEN</p> <ul style="list-style-type: none"> • Fluid accidentally injected into the skin must be surgically removed within a few hours by a doctor familiar with this form of injury or gangrene may result. <p>HOW TO AVOID THE HAZARD</p> <ul style="list-style-type: none"> • Keep body and hands away from pin hole leaks or nozzles that eject high pressure hydraulic fluid. • Use cardboard or paper to find hydraulic leaks, never use your hands.