

Installation Guide

PERLATO

Perlato Slat Wall Mount Vanities

IMPORTANT

Before beginning installation, make sure that the vanity is the correct model and size and conduct a thorough inspection.

1. Measure width of vanity from inner left side to inner right side. Determine height by measuring distance from metal hooks to vanity base and adding desired distance from vanity base to floor. Mark wall appropriately.

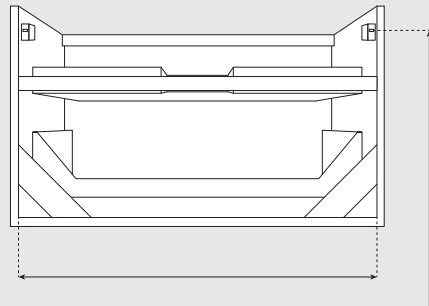

2. Separate the two hanging brackets by bending and cracking apart the included hardware. Drill mounting holes in wall and fasten wall brackets with screws.

Ensure brackets will be anchored to wall studs or reinforce wall for support.

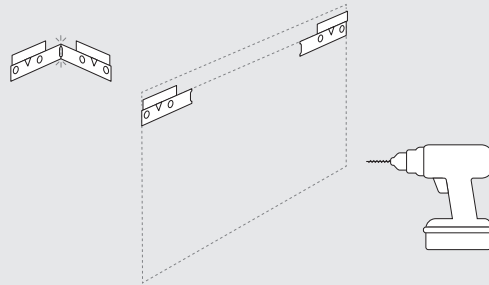

3. Remove drawers to facilitate installation process. Slide drawer forward, then gently tilt upwards and pull out completely.

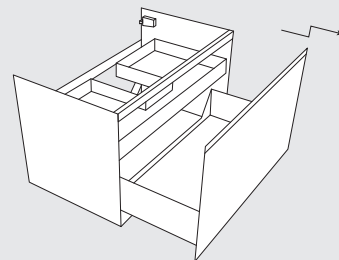

4. Hook vanity onto wall brackets. Mount support bracket onto wall directly under vanity base.

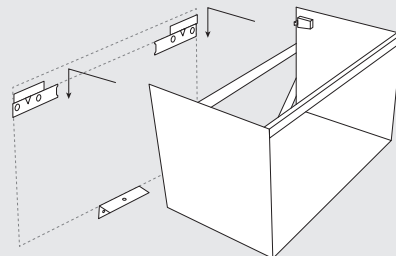

5. Adjust metal hooks if necessary to properly level vanity and secure it to wall.

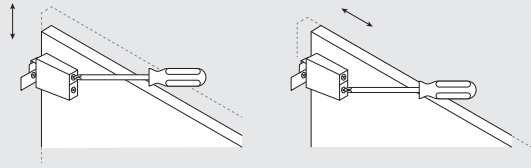

6. Attach faucet and drain to sink.

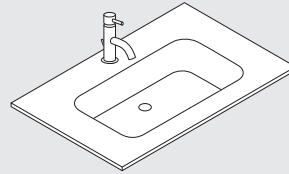

7. Spread non-acetic silicone sparingly along top rim of vanity. Position sink in place and use a cloth to wipe excess silicone.

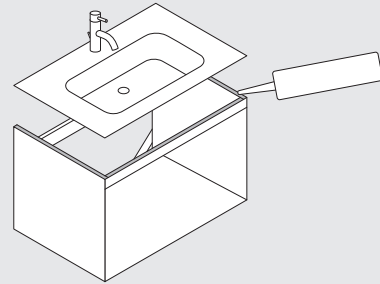

8. Connect water supply and drain lines. Run faucet and check for leaks.

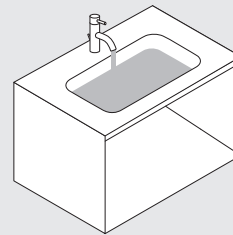

9. Slide drawers back onto tracks. Refer to instructions on next page if drawer front position needs adjustment.

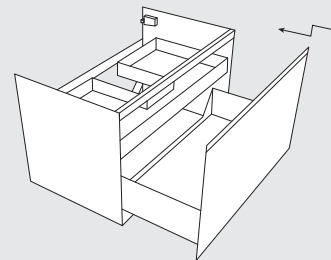

Drawer Adjustments *optional*

HORIZONTAL OR VERTICAL ADJUSTMENT

Slide back the covers on drawer sides to access hidden alignment mechanisms.

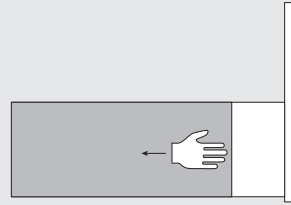

Rotate setting to align drawer front horizontally.

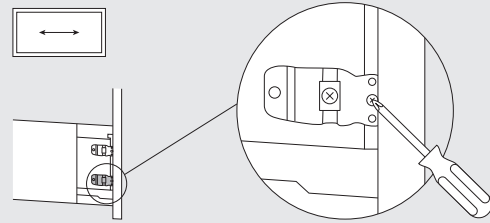

Rotate setting to align drawer front vertically.

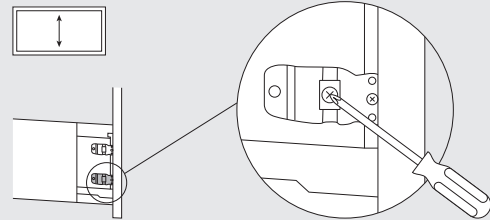

ANGLE ADJUSTMENT

Lift strip covering drawer sides to expose more adjustment settings.

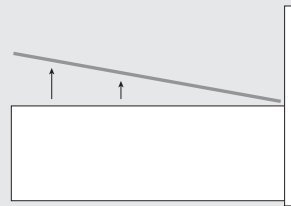

Rotate setting to make tilt angle adjustments.

