

INSTRUCTION MANUAL FOR DL-3702

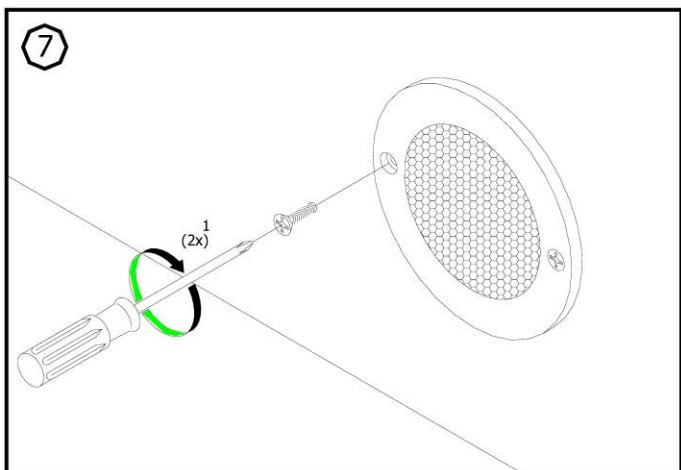
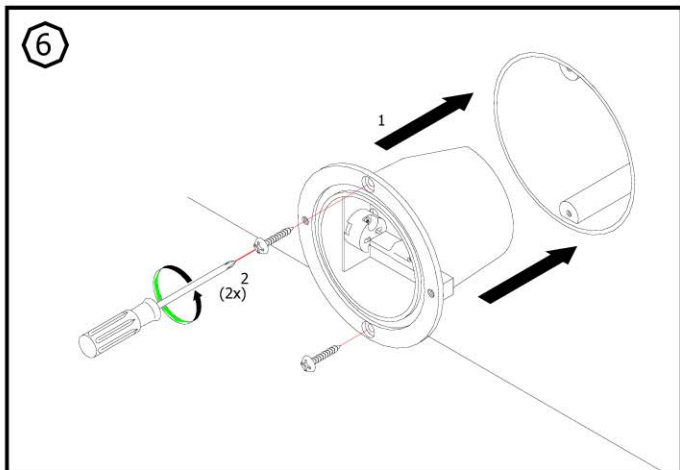
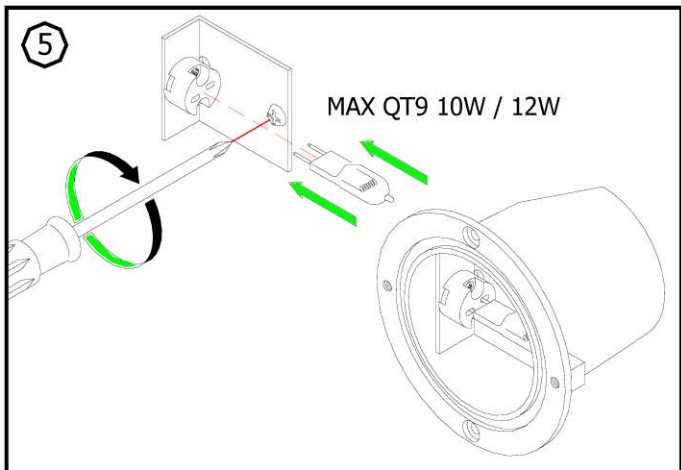
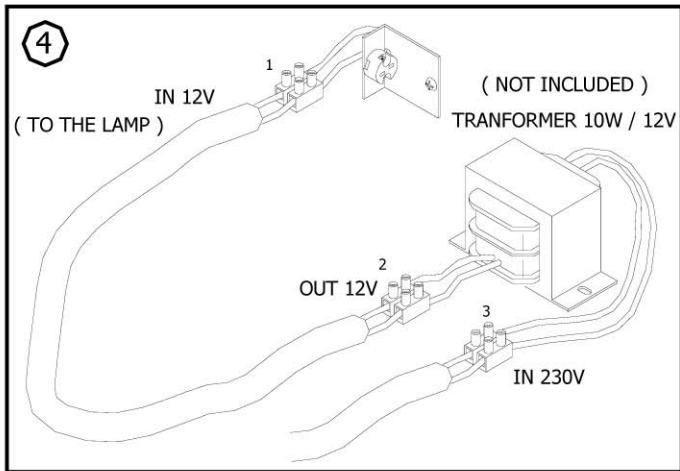
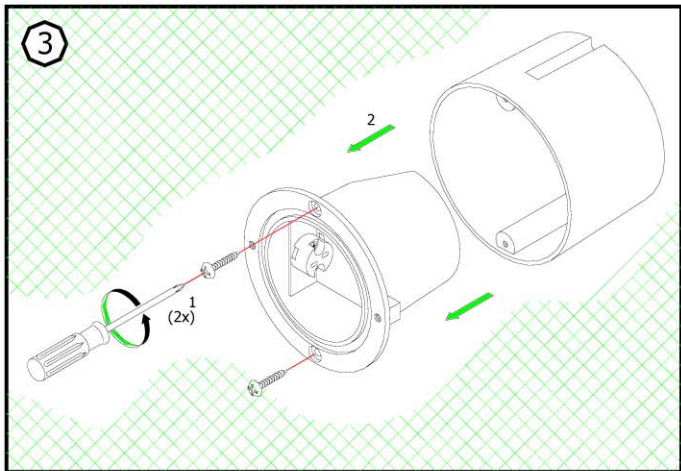
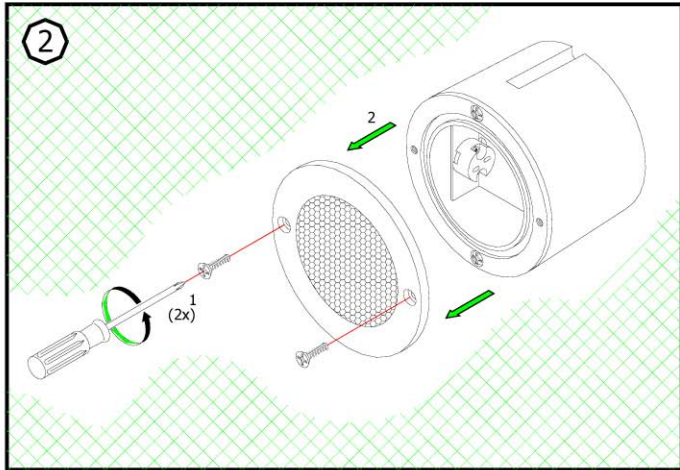
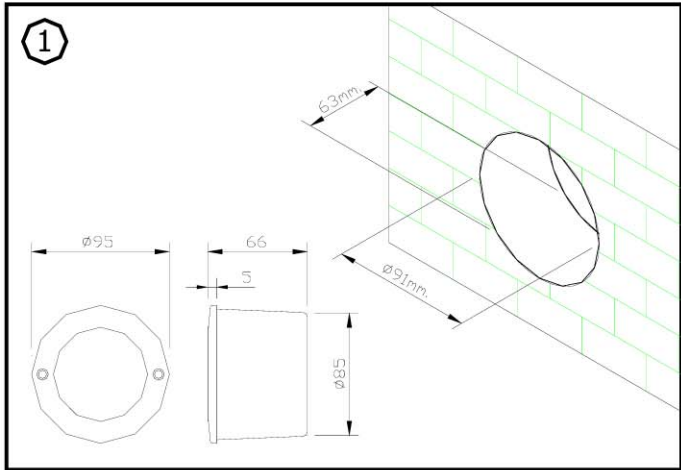

Applicable lamp :

1	12V 50Hz MAX QT9 10W

REMARK :

- 1 INSTALLATION SHOULD BE CARRIED OUT BY A QUALIFIED ELECTRICIAN IN ACCORDANCE WITH APPROPRIATE NATIONAL WIRING REGULATION.
- 2 DISCONNECT THE POWER BEFORE CHANGING THE LAMP.
- 3 THIS IS CLASS 3 LIGHTING FIXTURE (SAFETY EXTRA - LOW VOLTAGE)
- 4 DO NOT EXCEED THE MAXIMUM WATTAGE.

