

INSTRUCTION MANUAL FOR DL-3912

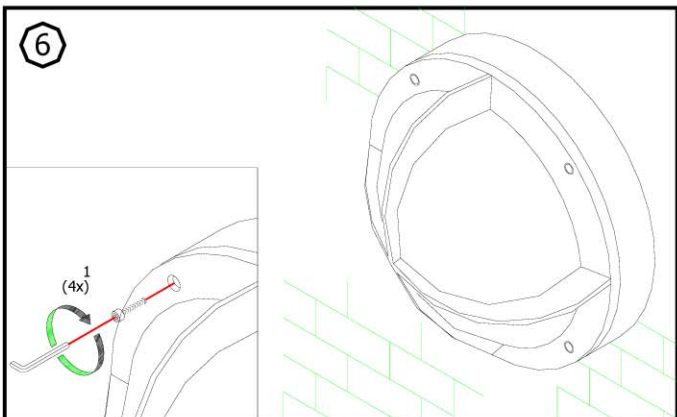
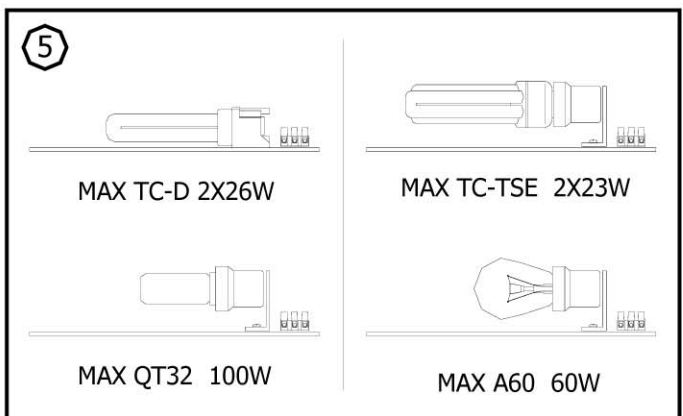
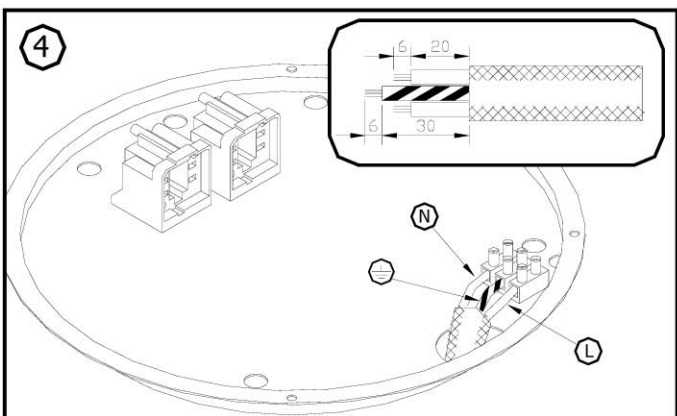
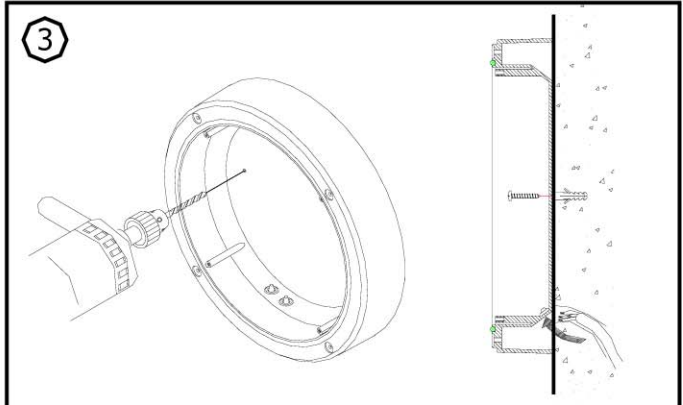
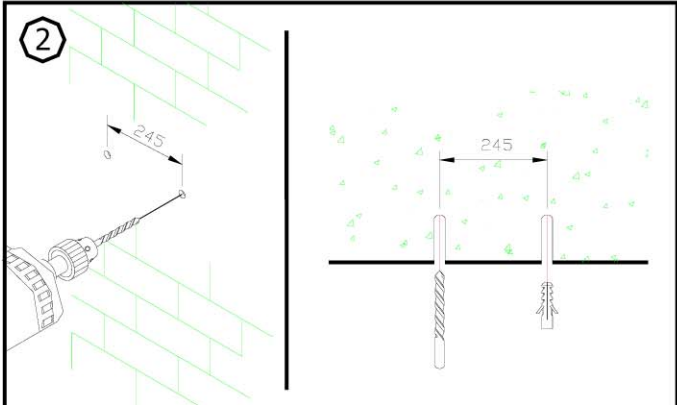
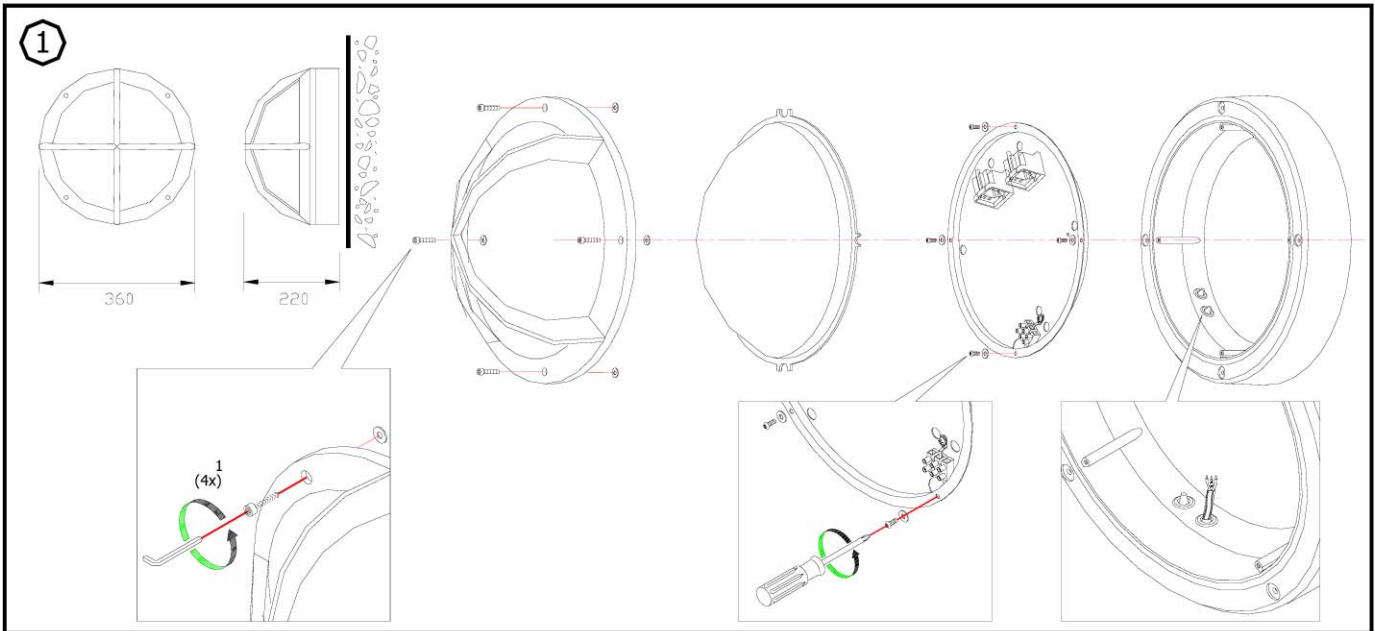

Applicable lamp :

230V 50Hz MAX TC-D 2X26W	230V 50Hz MAX A60 100W
230V 50Hz MAX TC-TSE 2X23W	
230V 50Hz MAX QT32 100W	

REMARK :

- 1 INSTALLATION SHOULD BE CARRIED OUT BY A QUALIFIED ELECTRICIAN IN ACCORDANCE WITH APPROPRIATE NATIONAL WIRING REGULATION.
- 2 DISCONNECT THE POWER BEFORE CHANGING THE LAMP.
- 3 THIS IS CLASS 1 LIGHTING FIXTURE AND MUST BE EARTHED.
- 4 DO NOT EXCEED THE MAXIMUM WATTAGE.

