

## Contact Details

Before using the product, please check the guide pages at the front of this catalog.

Internet

<http://www.daikinpmc.com/en/>

For latest information, PDF catalogs and operation manuals

# 02 Series Stacking Type Pilot Operated Check Valves

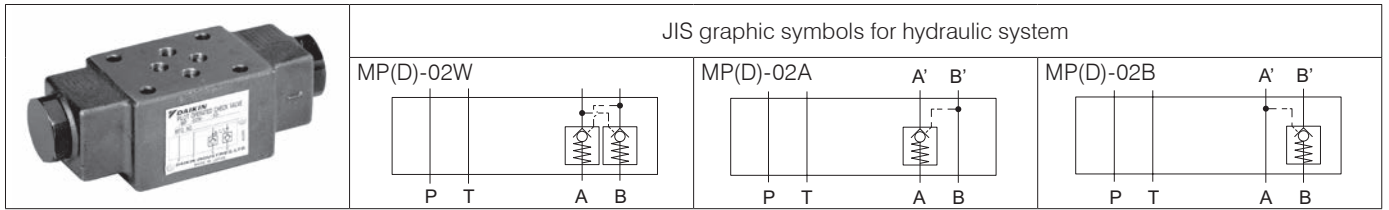

## Nomenclature

- 1 **Applicable fluid code**  
 No designation: Petroleum-based hydraulic fluid, water-glycol hydraulic fluid  
 F: Phosphate ester hydraulic fluid
- 2 **Model No.**  
 MP: Modular stacking type pilot operated check valve
- 3 **Decompression code**  
 No designation: Direct operated type  
 D: Decompression type (applicable only to design No. 55)
- 4 **Nominal diameter**  
 02: ¼
- 5 **Control port**  
 W: Port A/B  
 A: Port A  
 B: Port B
- 6 **Cracking pressure code**  
 20: 0.2 MPa {2 kgf/cm<sup>2</sup>}  
 50: 0.5 MPa {5 kgf/cm<sup>2</sup>}
- 7 **Design No.**  
**(The design No. is subject to change)**  
 55: 25 MPa {250 kgf/cm<sup>2</sup>}  
 60: 35 MPa {350 kgf/cm<sup>2</sup>}

## Specifications

Model code	Maximum operating pressure MPa {kgf/cm <sup>2</sup> }	Maximum flow rate L/min	Cracking pressure MPa {kgf/cm <sup>2</sup> }	Area ratio *1	Mass kg
MP×-02×-20-55	25 {250}	40	0.2 {2}	(1) 2.7 :1	1.1
MP×-02×-50-55			0.5 {5}		
MP-02×-20-60	35 {350}		0.2 {2}	(2) 1.96:1	1.2
MP-02×-50-60			0.5 {5}		

Note: \*1 Area ratio (1) <MP> Pilot piston: Check valve (2) <MPD> Pilot piston: Large check valve (3) <MPD> Pilot piston: Small check valve

## Handling

- The internal drain type is adopted.

## Performance curves (viscosity: 32 mm<sup>2</sup>/s {cSt})

### Pressure drop characteristics

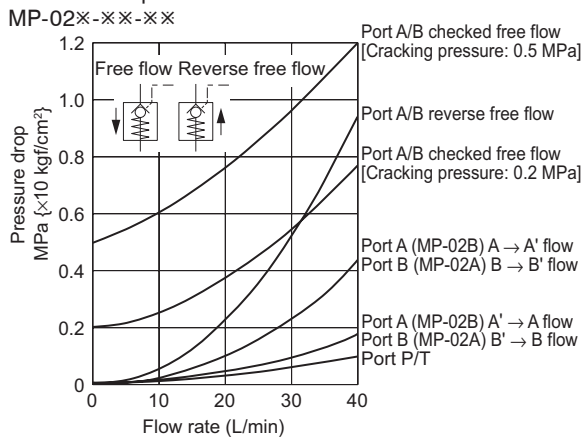

### Pilot pressure characteristics

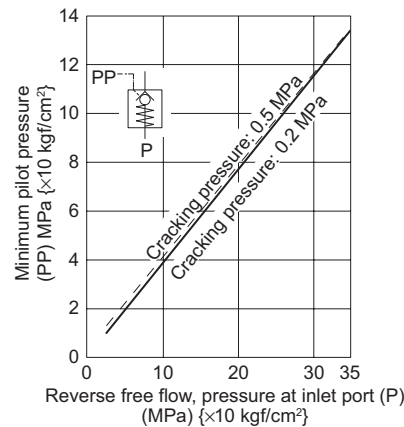

### Pressure drop characteristics

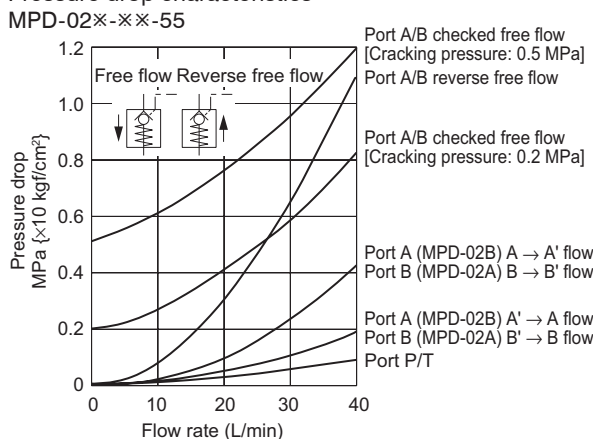

### Pilot pressure characteristics

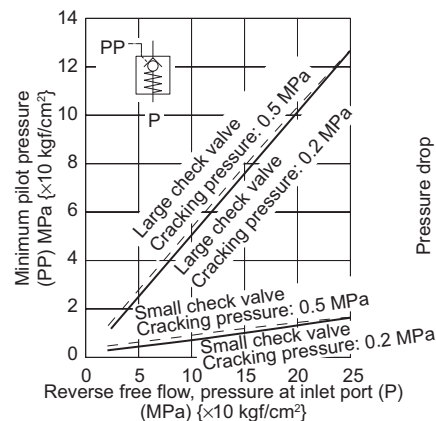

### Pressure drop characteristics with the small valve fully open

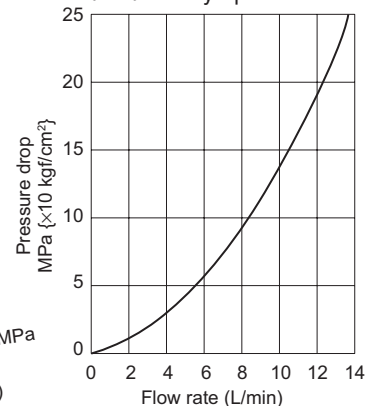

## Contact Details

Before using the product, please check the guide pages at the front of this catalog.

Internet

<http://www.daikinpmc.com/en/>

For latest information, PDF catalogs and operation manuals

## External dimension diagram

MP(D)-02W-55

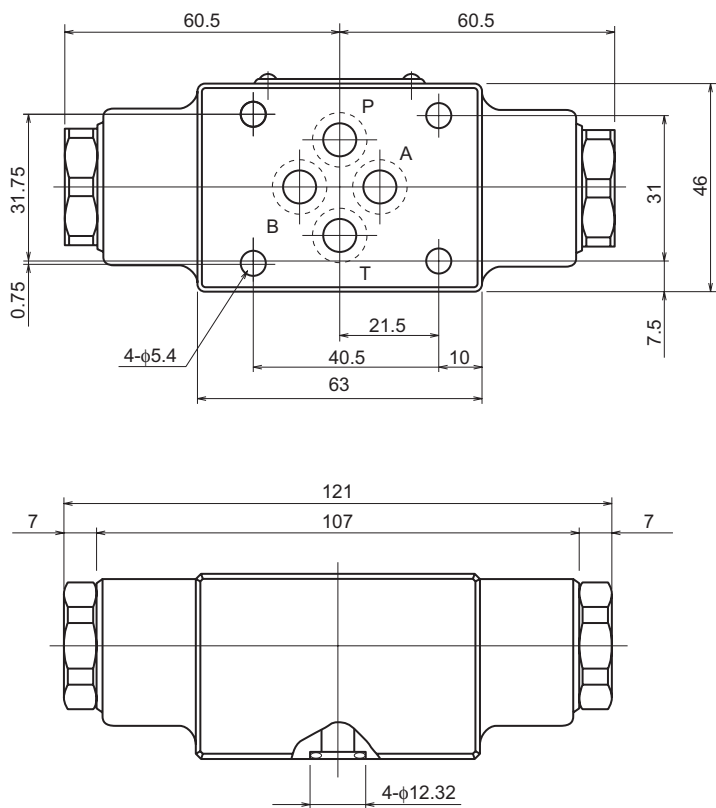

MP(D)-02A-55

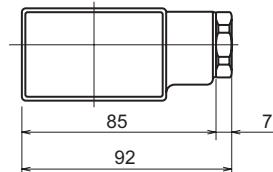

MP(D)-02B-55

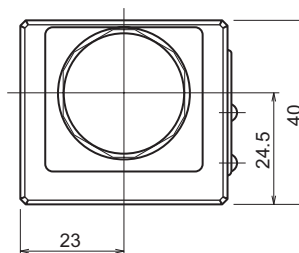
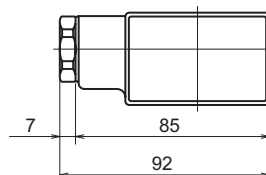

## Sectional structural diagram

MP-02※-55

MPD-02※-55

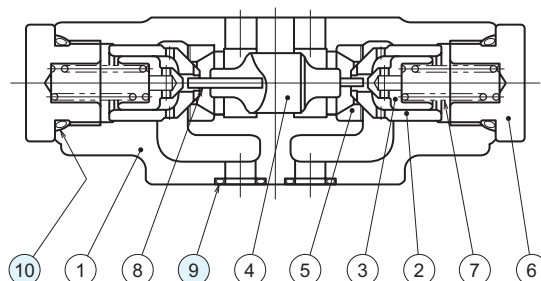
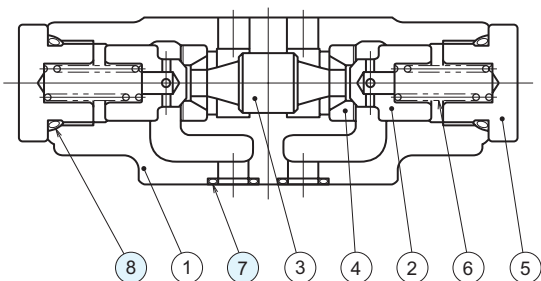

### Sealing part table

Part No.	Name	Quantity		Part specifications
		MP-02W	MP-02A, B	
7	O-ring	4	4	AS568-012 (NBR, Hs90)
8	O-ring	2	1	JIS B 2401 1B P18

### Sealing part table

Part No.	Name	Quantity		Part specifications
		MPD-02W	MPD-02A, B	
9	O-ring	4	4	AS568-012 (NBR, Hs90)
10	O-ring	2	1	JIS B 2401 1B P18

