



SS1080HF

SAFARI V-SPEC SNORKEL
JEEP JL WRANGLER 2018 All Models
Suits: All Engine Variants



24/06/2019

Parts List

ITEM	PART NO.	DESCRIPTION	QTY
1	957-133-000	BODY - SNORKEL (SS1080HF)	1
2	000-135-960	4" AIR RAM ASSEMBLY	1
3	957-032-000	BRACKET - UPPER MOUNTING (Windshield Frame)	1
4	957-032-200	BRACKET - SNORKEL BODY MOUNTING (Fender - Main)	1
5	957-032-300	BRACKET - SNORKEL BODY MOUNTING (Fender - Front)	1
6	000-041-400	BOLT - TORX - 8mm x 1.25mm x 12mm - S/S	6
7	000-038-400	BOLT - TORX - 6mm x 1.0mm x 12mm - S/S	2
8	000-1023-400	BOLT - TORX - 5mm x 0.8mm x 20mm - S/S	3
9	000-320-300	WASHER - FLAT - 5.0mm x 10mm - S/S	3
10	000-221-300	NUT - NYLOC - 5mm x 0.8mm - S/S	3
11	957-435-000	GASKET - UPPER MOUNTING BRACKET (Rubber)	1
12	957-719-000	BEZEL - HOOD SUPPORT	1
13	000-958-625	POP RIVET - 4.8mm x 10mm (Black Anodised)	9
14	000-320-350	WASHER - BODY - 5.0mm x 15mm - S/S	3

15	957-024-000	HOSE - AIR ENTRY (Flanged)	1
16	957-025-000	PLATE - HOSE SUPPORT - (Upper)	1
17	957-025-025	PLATE - HOSE SUPPORT - (Lower)	1
18	957-025-050	PLATE - HOSE SUPPORT - (Side Lower)	2
19	957-025-075	PLATE - HOSE SUPPORT - (Side Upper)	2
20	000-958-175	POP RIVET - 4.0mm x 17mm	13
21	000-094-300	BOLT - B/H - 4.0mm x 0.7mm x 20mm - S/S	2
22	000-300-350	WASHER - BODY - 4.0mm x 12mm - S/S	7
23	000-223-300	NUT - NYLOC - 4mm x 0.7mm - S/S	2
24	957-016-000	HOOD - INFILL (Front)	1
25	957-016-100	HOOD - INFILL (Rear)	1
26	957-332-000	CLIP - ANTENNA MOUNTING	1
27	000-958-160	POP RIVET - 4.0mm x 13mm (Black Anodised)	2
28	000-1912	CLAMP - HOSE - 110/130mm - S/S	1
29	000-1931/B	HOSE - CLAMP - SIZE 64 (Black)	1
30	957-217-000	TEMPLATE - AIR CLEANER HOUSING (Upper)	1
31	957-217-050	TEMPLATE - AIR CLEANER HOUSING (Lower)	1
32	957-217-100	TEMPLATE - AIR CLEANER HOUSING (Front Upper)	1
33	957-217-150	TEMPLATE - AIR CLEANER HOUSING (Front Lower)	1
34	957-217-200	TEMPLATE - AIR CLEANER HOUSING (Rear Upper)	1
35	957-217-250	TEMPLATE - AIR CLEANER HOUSING (Rear Lower)	1
36	957-017-000	TEMPLATE – HOOD CUT	1

Installation Guide

Fitment to:

- Right Hand Side

Fitting Time:

- 240min

Special Tools:

- Body Saw (Reciprocating)
- 24 or 32 TPI Hacksaw Blade
- 4.5, 5.0 & 5.5mm Drill Bits
- Files
- Torx & Allen Key Set
- Clip Removal Tool
- Vernier Calipers
- Pop Rivet Gun
- Masking Tape
- Primer and Touch-up paint
- Sikaflex 227 Adhesive Sealant
- Plastic Drop Sheet

Prior to commencing the installation, it is the installer's responsibility to verify that all components and particularly the template (Item 36) are correct.

1

Remove the following in accordance with the factory service manual:

- Air Cleaner Assembly
- Hood Liner

Note: Completely cover the air intake duct with a plastic bag or workshop rags to ensure no debris enters the air intake whilst installing the snorkel.

2

Remove and retain the three fender bolts shown.

Apply masking tape to the fender to prevent any scratches to paint whilst fitting the snorkel body (item 1) to the vehicle.

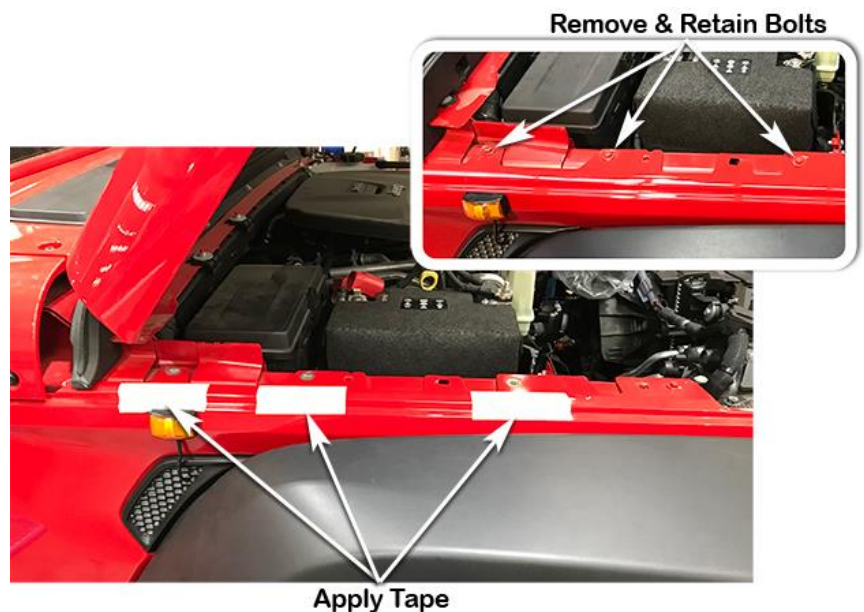

3

Prop the hood up slightly onto a cardboard packaging box.
Apply masking tape along the RHS of the hood, 300mm long lengths of tape from behind the hood catch and 200mm high as shown.

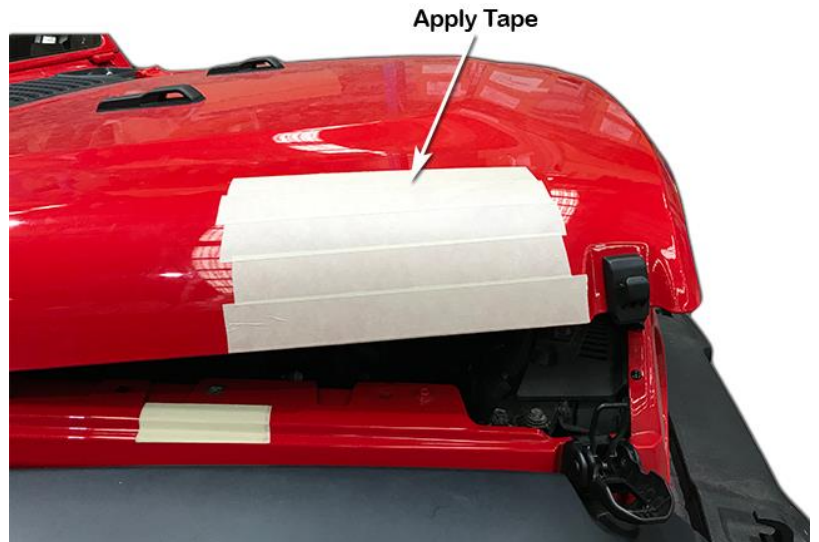

4

Align the hood cut template (Item 36) with the rear and lower edges of the hood as shown.

Tape the template to the hood with masking tape.

Using a ball point pen, mark the 3 hole positions and the hood cut-out.

Remove the template.

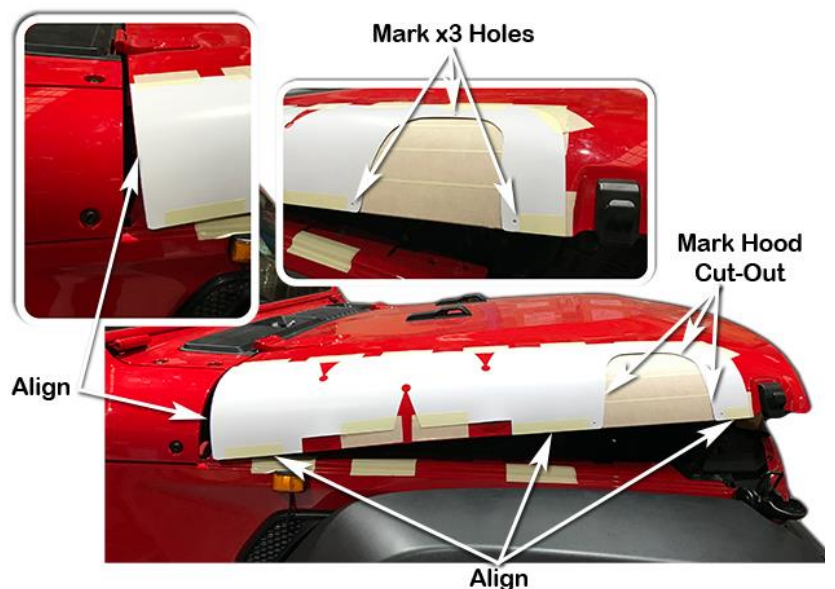

5

Using a plastic drop sheet, cover the entire engine bay, fender flares, bumper and scuttle panel.

Tape the plastic drop sheet to vehicle in several positions.

Note: Rubicon models, apply masking tape over both hood vents to prevent aluminum swarf from being trapped between the vent and hood.



6

With the hood propped up slightly on the cardboard packaging box.

Drill a pilot hole at the three marked hole positions.

Using a 5.0mm drill bit, enlarge the three pilot holes to 5.0mm diameter.

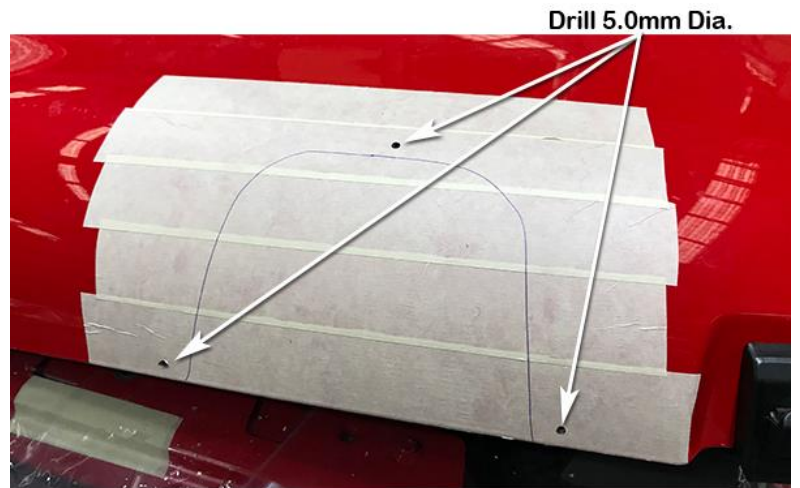

7

With the hood still propped up, install the hood support bezel (item 12) to the hood, loosely install three pop rivets (item 13) as shown, with the hood support bezel correctly aligned on the hood, using a ball point pen, mark the remaining six mounting hole positions.

Remove the three pop rivets and hood bezel.

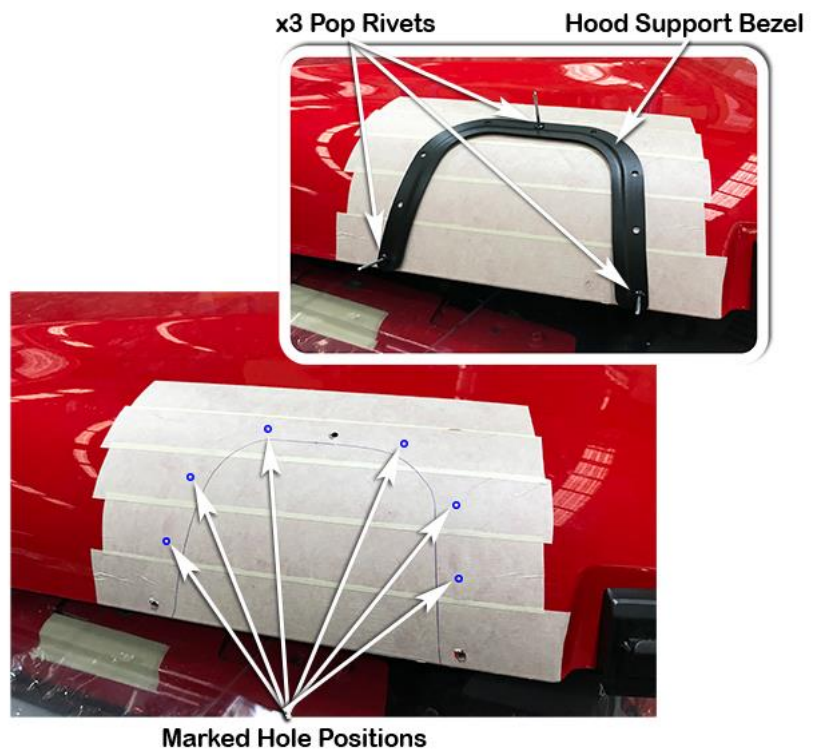

8

Drill a pilot hole at the six marked hole positions.

Using a 5.0mm drill bit, enlarge the six pilot holes to 5.0mm diameter.

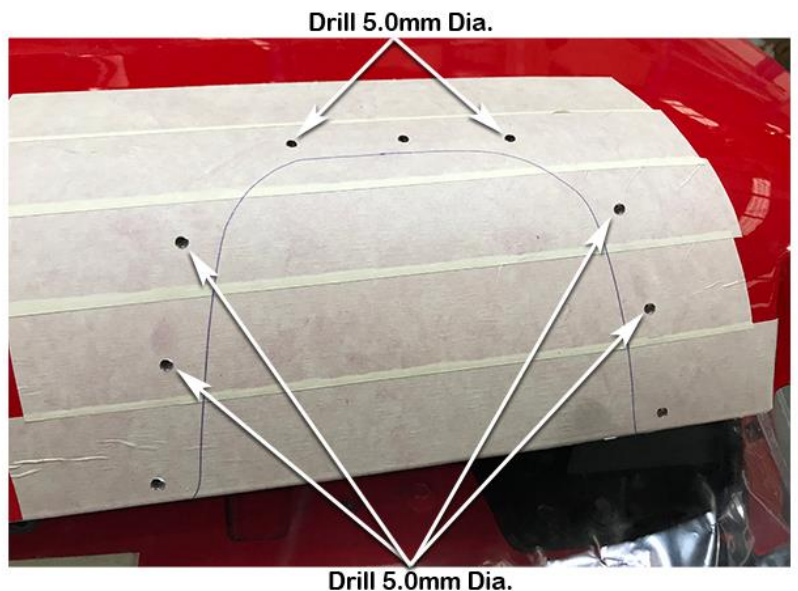

A custom body saw blade is required for cutting the hood.

Using a 24 or 32 TPI hacksaw blade make the custom body saw blade as per the body saw blade template attached to the instructions.

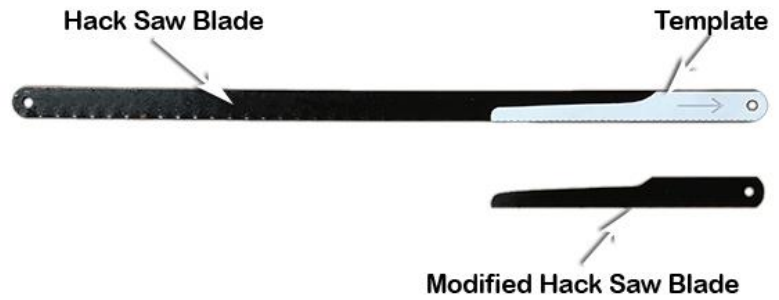

Using the body saw with the custom body saw blade installed, cut-out the section of the hood as marked in step 4, cutting on the outside of the marked cutting line and through both the outer and inner hood panels.

Remove the masking tape, deburr the cut edges of the hood and the nine mounting holes.

Using compressed air thoroughly clean the hood of all aluminum swarf / filings.

Clean and prepare the nine holes and the hood cut-out for painting, paint the nine holes and the hood cut-out with a primer and then touch-up paint.

Remove and discard the plastic drop sheet.

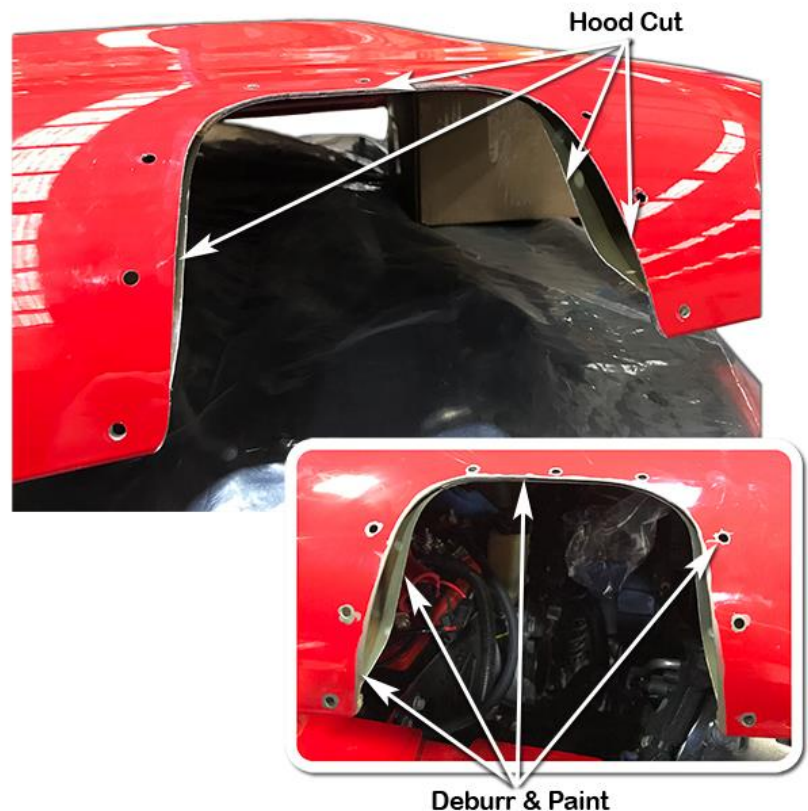

With variations in the assembly of the hood from the factory, it may be necessary to install spacer washers between the outer and inner panels of the hood (*refer to photo*), the three M5 body washers (item 14) supplied in the kit are only to be installed if there is no seam sealer between the hood sheet metal at any of the three upper hood support bezel holes.



Install M5 Body Washer(s) - (if no seam sealer)

Apply a smear of adhesive sealant to the hood support bezel (item 12), install the hood support bezel into position and install all nine pop rivets (item 13).

With all nine pop rivets installed secure the hood support bezel to the hood using a pop rivet gun.

Clean-up any excess sealant to ensure a neat finish.

Install Pop Rivets



Installed Hood Bezel

Apply a bead of adhesive sealant along the inside edge of the hood and hood support bezel to seal, apply adhesive sealant to the front and rear hood cavities and the front and rear hood infills (item's 24 & 25).

Install the front and rear hood infills flush with the cut edges of the hood.

Clean-up any excess sealant to ensure a neat finish.



Install Front Hood Infill

Install Rear Hood Infill

Apply Sealant



Apply Sealant

Remove and discard the air inlet duct from the air cleaner base.



Remove & Discard

Using a sharp knife, cut the tabs retaining the six individual air cleaner templates from the template sheet.

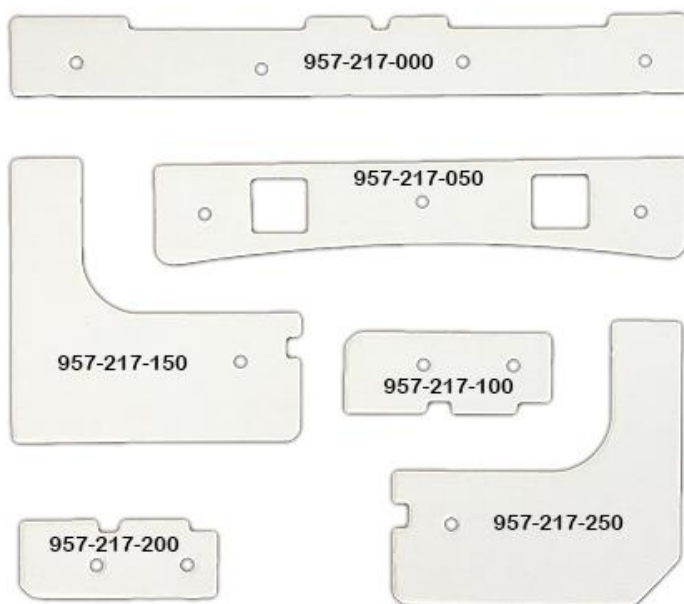

Using a body saw, grinder, sharp knife or cutters, neatly remove the marked ribs shown from the front, rear and entry of the air cleaner base as shown.



Neatly apply masking tape to the lower flange of the air cleaner base inlet, align the lower template (item 31) to the two square holes and the front edge of the flange as shown.

Using a ball point pen mark the 3 hole positions.

Remove the template.



Neatly apply masking tape to the lower front surface of the air cleaner base, align the front lower template (item 33) to the air cleaner base as shown.

Using a ball point pen mark the one hole position and the cutting line.

Remove the template.

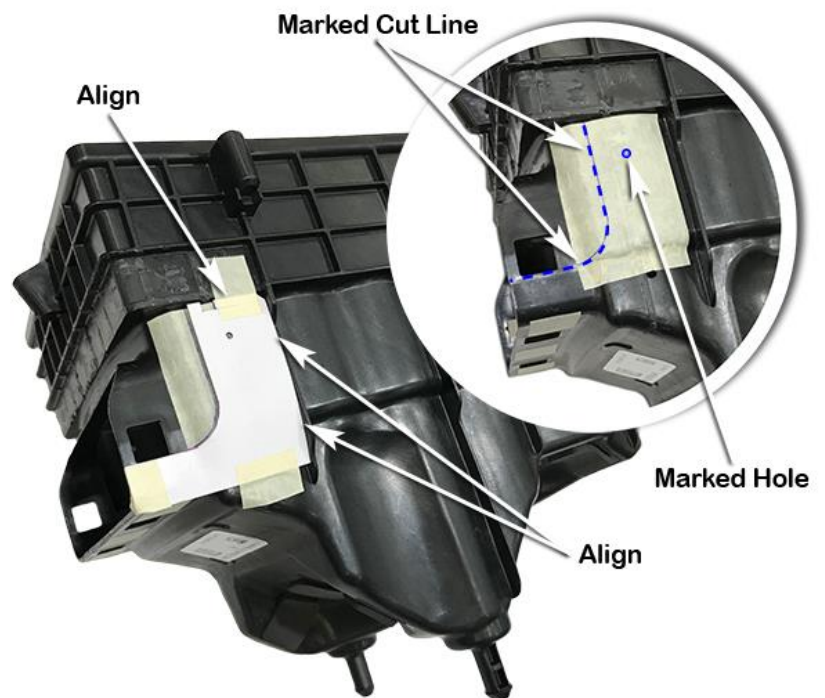

Neatly apply masking tape to the lower rear surface of the air cleaner base, align the rear lower template (item 35) to the air cleaner base as shown.

Using a ball point pen mark the one hole position and the cutting line.

Remove the template.

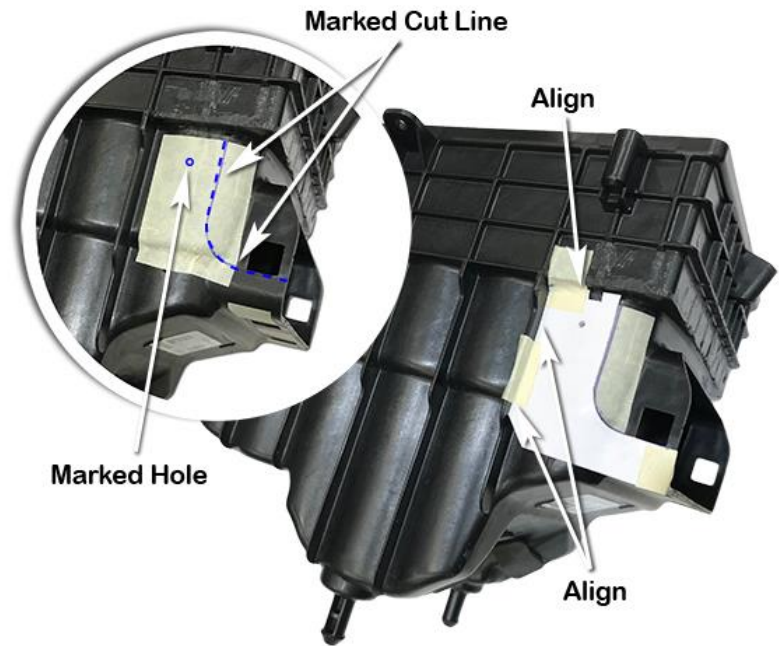

Neatly apply a thin strip of masking tape to the upper front, upper rear and upper entry surfaces of the air cleaner base, align the front upper template (item 32) to the air cleaner base as shown.

Using a ball point pen mark the two hole positions.

Remove the template.

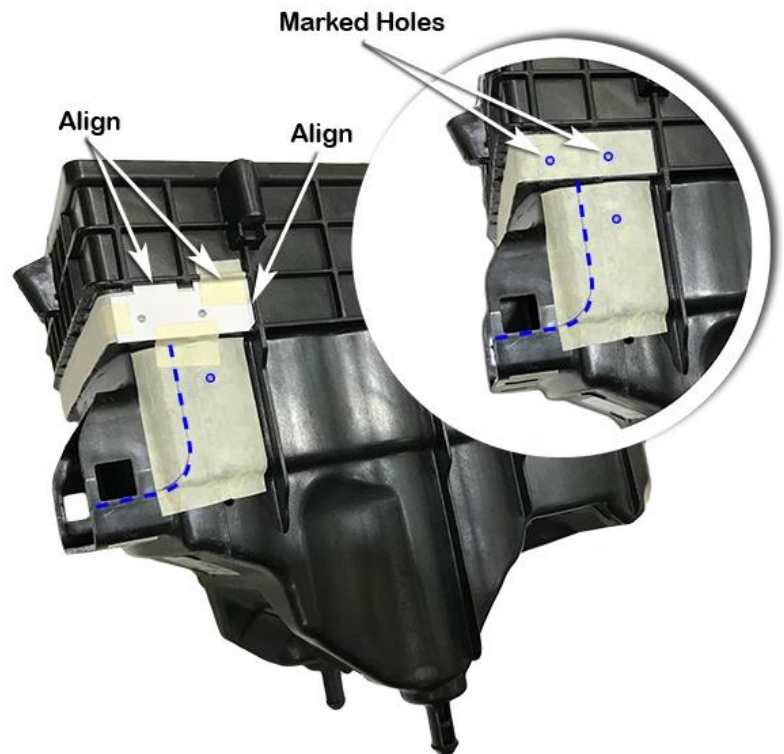

Align the rear upper template (item 34) to the air cleaner base as shown.

Using a ball point pen mark the two hole positions.

Remove the template.

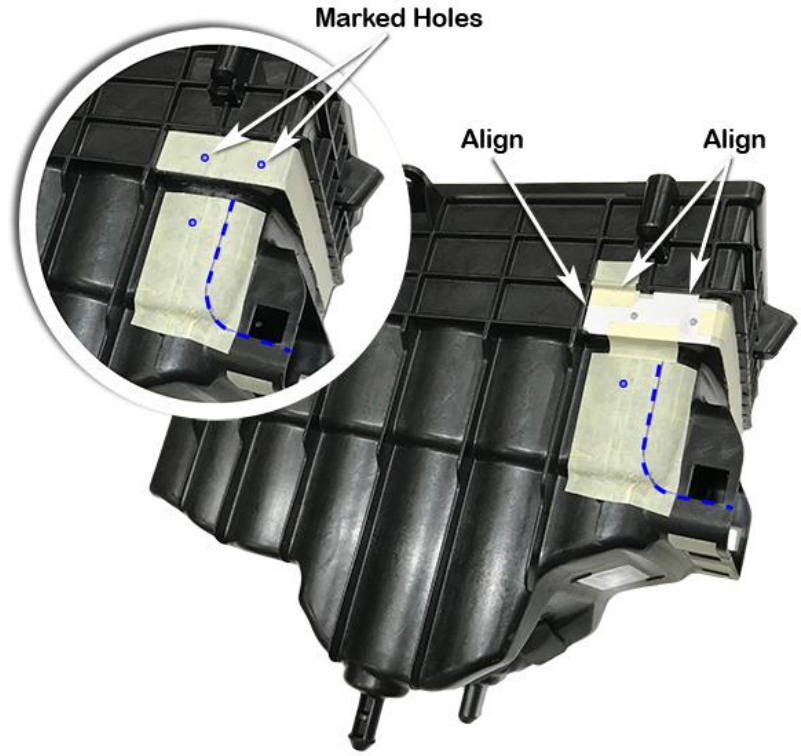

Align the upper template (item 30) to the air cleaner base as shown.

Using a ball point pen mark the four hole positions.

Remove the template.

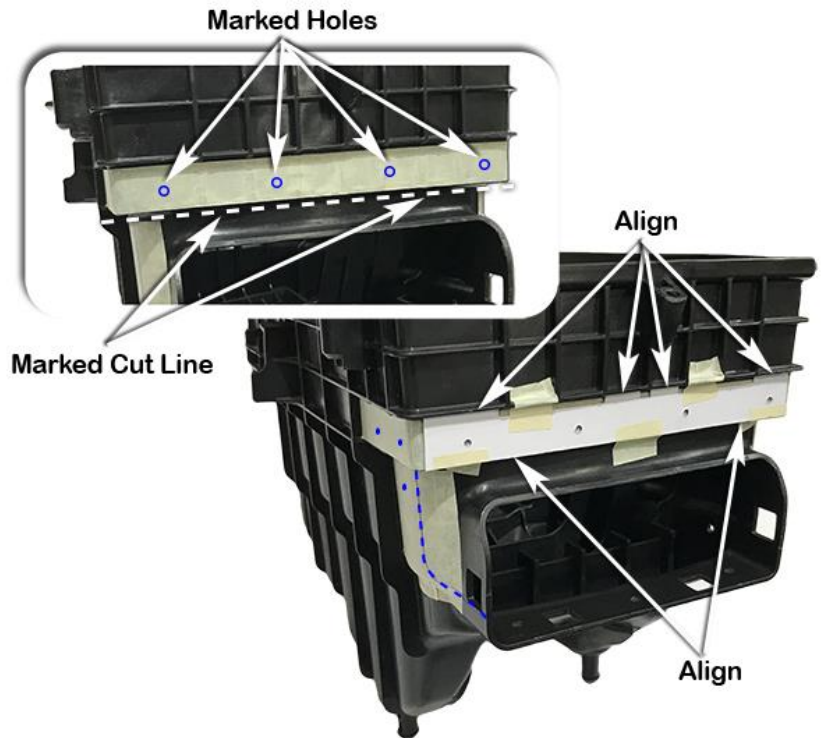

Drill a pilot hole at each of the thirteen marked hole positions.

Using a 4.5mm drill bit, drill the pilot holes to 4.5mm diameter as shown.

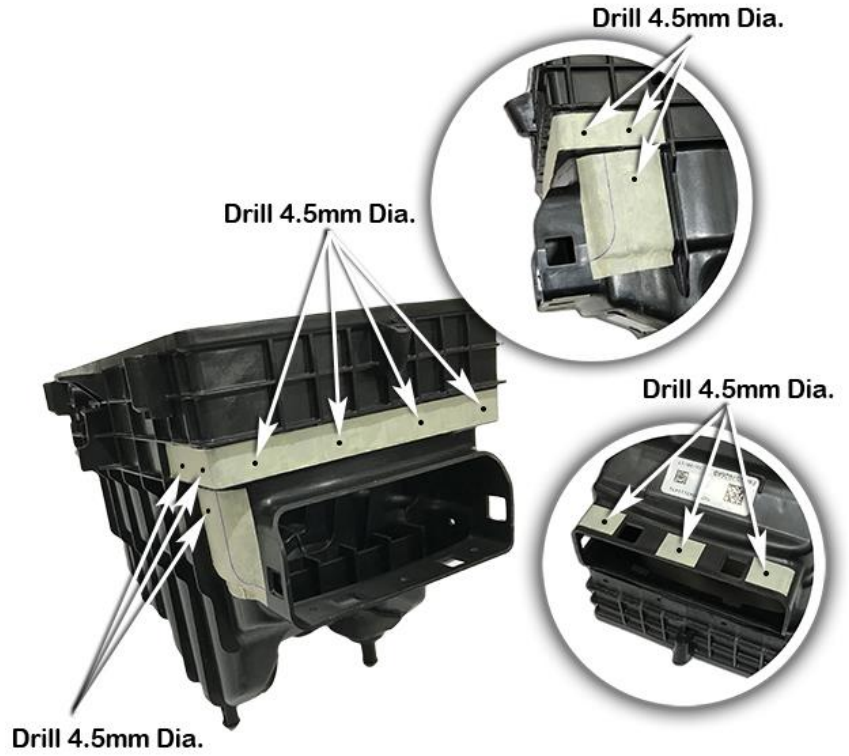

Using the body saw cut the new air inlet hole as marked from the templates in steps 18 & 19 and cutting under the shoulder of the air cleaner base front to rear as shown.

Use a file or die grinder to clean-up the cut sections.

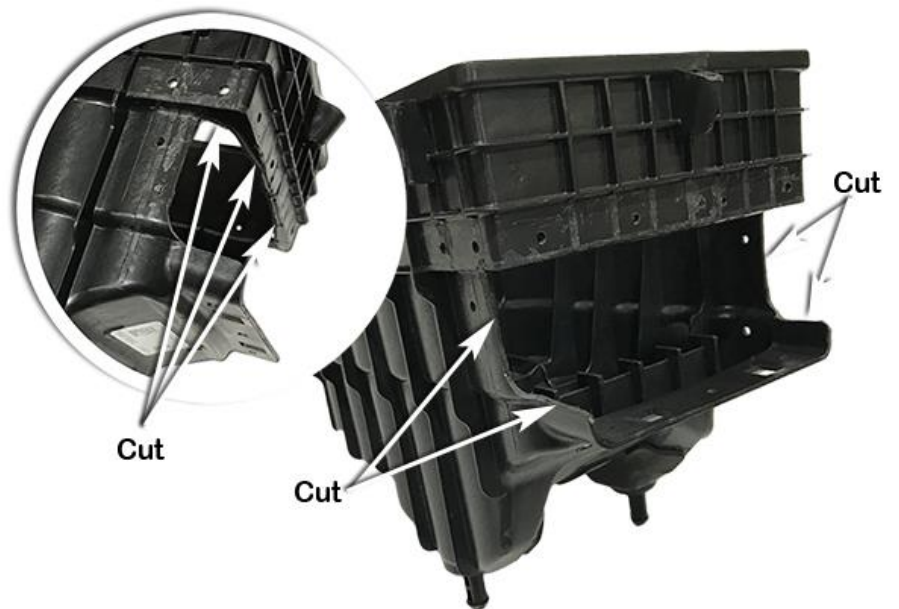

Place a strip of masking tape on the front and rear lower sections of the air cleaner base.

Install the air entry hose (item 15) onto the air cleaner base, loosely install several pop rivets (item 20) to hold the hose in place while you mark the two lower hole positions as shown.

Remove the pop rivets and hose.



Drill a pilot hole at the two marked hole positions.

Using a 4.5mm drill bit, drill the two pilot holes to 4.5mm diameter as shown.



Using a body saw / die grinder, neatly remove the 1st set of internal ribs from the air cleaner base.

Ensure the ribs are neatly removed and are cut-off flush with the air cleaner base as shown.

Using compressed air, thoroughly clean out the inside of the air box from any plastic debris.



Apply a liberal amount of adhesive sealant to the air cleaner base flange and air entry hose flange and install the air entry hose onto the air cleaner base.

Install the upper hose support plate (item 16) and pop rivets (item 20), install the lower support plate (item 17), pop rivets (item 20) and M4 body washers (item 22) onto the three lower pop rivets as shown.

Install the side lower hose support plates (item 18) to the front and rear, install a pop rivet (item 20) through the top holes, install a M4 x 20mm button head bolt (item 21) through the lower holes, install a M4 body washer (item 22) and M4 nyloc nut (item 23) as shown.

Note: The orientation of all pop rivets, hose support plates, washers, bolts and nuts.



With the hose support plates, pop rivets and fasteners installed.

Using a pop rivet gun, secure all the pop rivets, tighten the two M4 nyloc nuts, securing the air entry hose to the air cleaner base.

Install the side upper hose support plates (item 18) and pop rivets (item 20) to the front and rear of the air cleaner base as shown.

Using a pop rivet gun secure the four pop rivets.

Clean-up any excess sealant to ensure a neat finish.



INSTALLER OPTION :

The air cleaner base contains four drain holes as shown. The drain holes can permit water to enter the air intake.

Safari advises that the drain holes should be sealed to ensure a watertight installation.

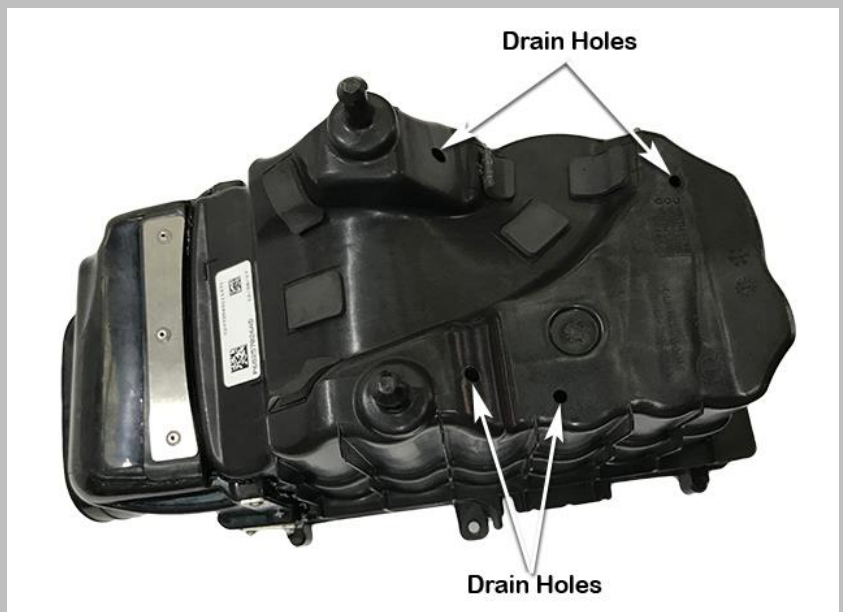

Apply lubricant to the two air cleaner base mounting pins and install the air cleaner base into position.

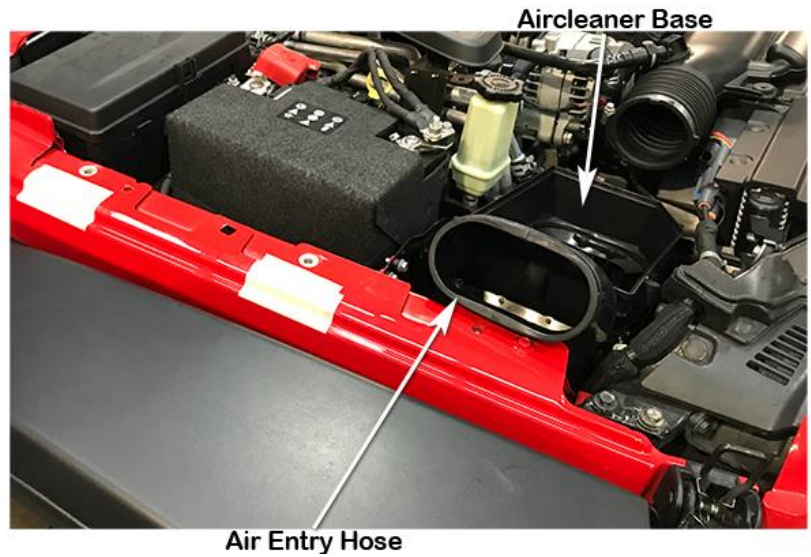

Install the snorkel body mounting brackets (item's 4 & 5) to snorkel body with M8 x 12mm Torx bolts (item 6), centralise the slots in the brackets to the 8mm brass mounting inserts.

Tighten the bolts, to retain the brackets in the correct position.

Install the upper mounting bracket (item 3) to the 6mm brass mounting inserts with M6 x 12mm Torx bolts (item 7).

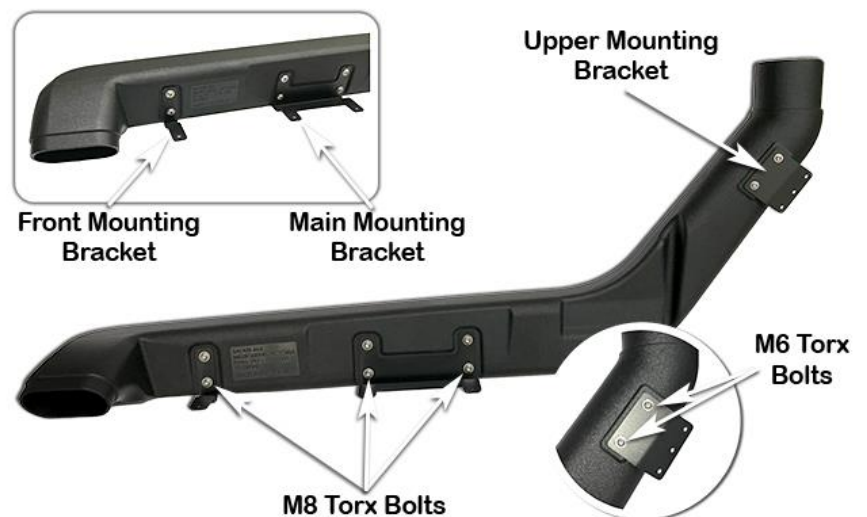

Apply a strip of masking tape along the windshield frame, using the Vernier calipers measure and mark a couple of lines 8mm in from the rear edge of the windshield frame, using a steel ruler extend the marked lines approximately 150mm long as shown.

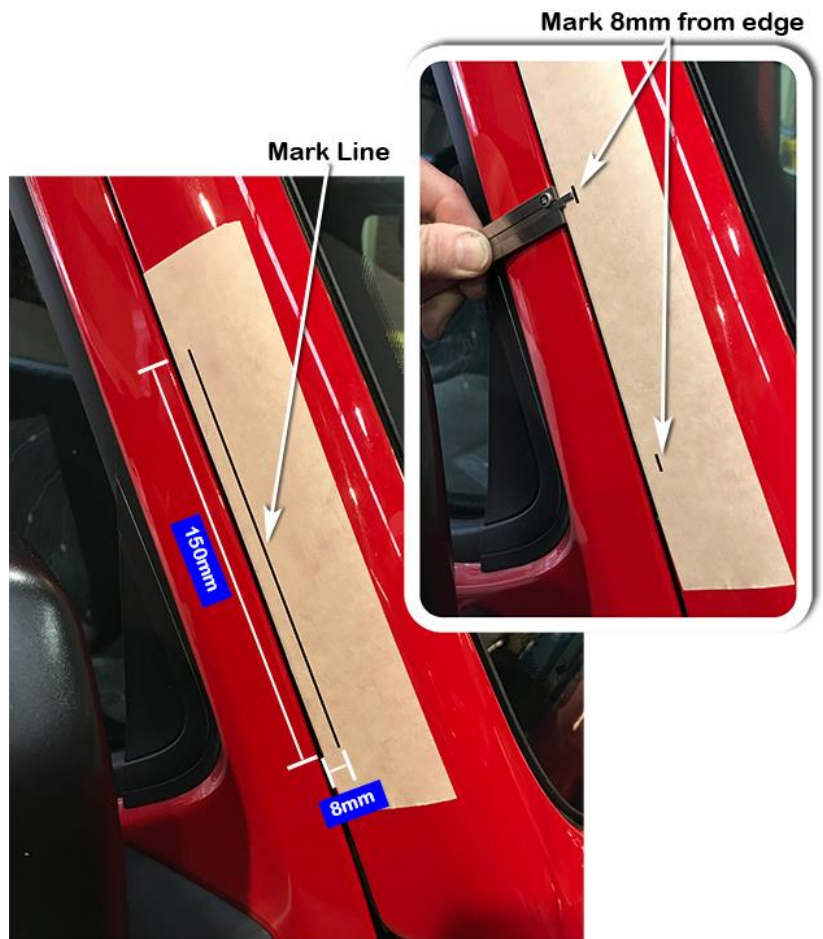

Carefully install the snorkel body (Item 1) to the fender, guiding the snorkel body outlet into the air entry hose (item 15), centralise the slots in the mounting brackets to the fender mounting holes and install the standard fender bolts.

Carefully lower the hood checking the clearance between the hood bezel and the snorkel body outlet, if required loosen the fender bolts or snorkel body mounting bolts and adjust the snorkel to gain an even gap front to rear between the hood bezel and snorkel body outlet.

When correctly aligned, fasten the fender bolts or snorkel body mounting bracket bolts.

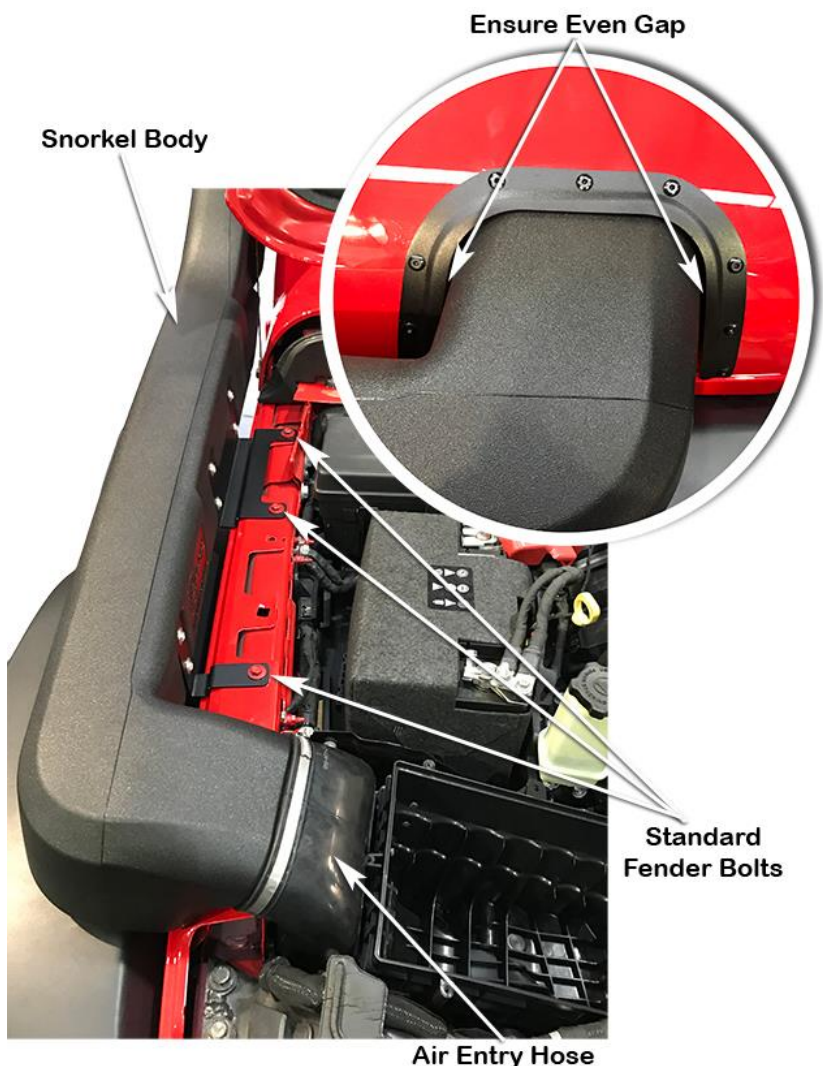

Align the centre of the three upper mounting bracket (item 3) mounting holes to the 8mm marked line on the windshield frame (marked in step 33), if required, loosen the mounting bracket bolts and adjust the bracket to align the mounting holes with the 8mm marked line.

With the bracket correctly aligned, mark the bracket position onto the masking tape.

Remove the snorkel body from the fender.

Remove the upper mounting bracket from the snorkel body.

Remove the masking tape from the fender.

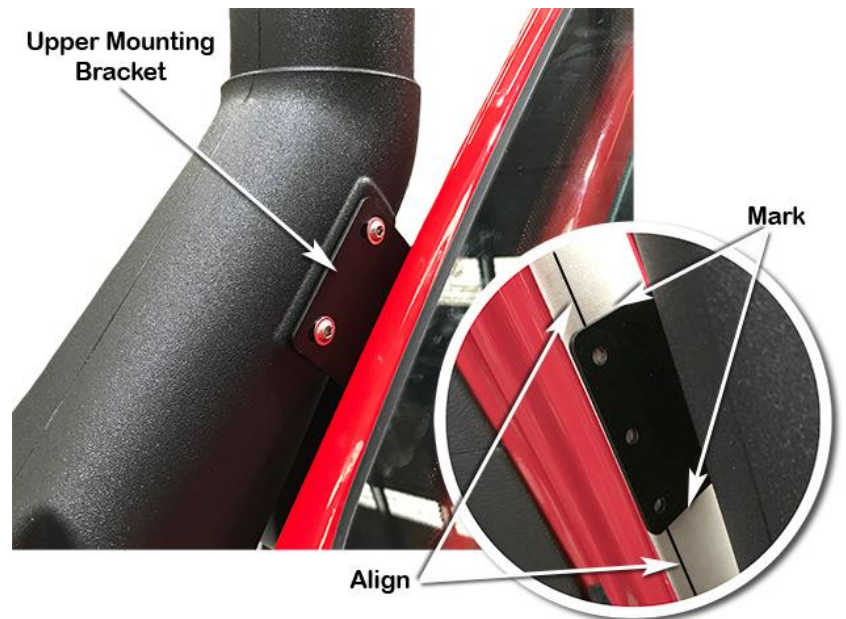

Position the upper mounting bracket onto the windshield frame and align the bracket with the marked bracket outline.

Mark the three mounting hole positions with a ball point pen.

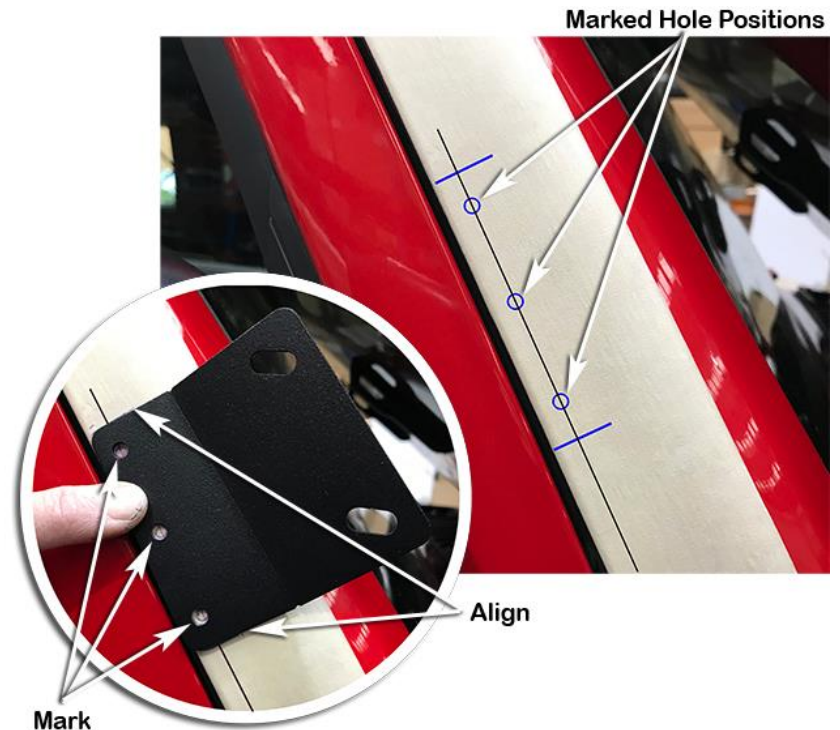

Using the Jeep tool kit, fold the windshield down as per the Jeep instruction booklet.

38

Apply masking tape to the entire perimeter of the windshield glass and windshield frame to prevent swarf from being trapped between the windshield glass and windshield frame. Cover the dashboard to prevent swarf from entering the vents and dashboard.

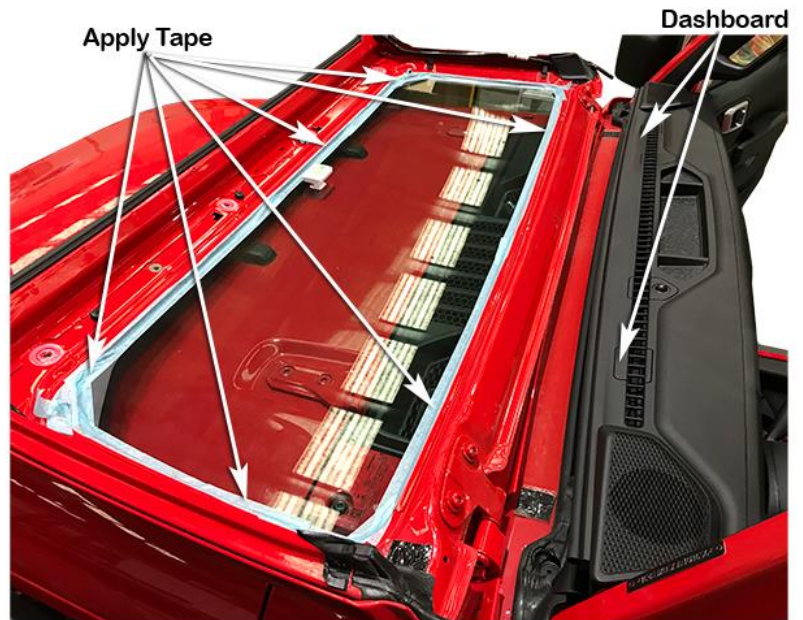

39

Lift up and tape the drain tube located in the windshield frame.

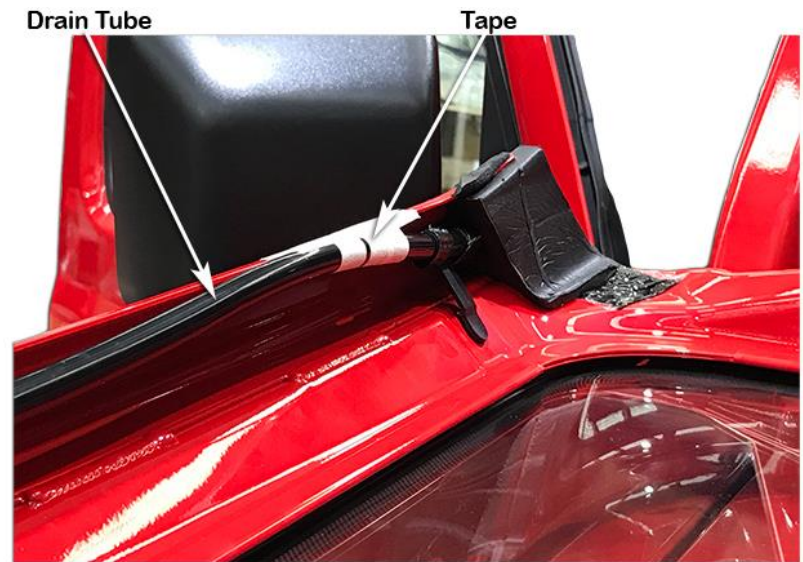

40

Drill a pilot hole for each of the three marked hole positions. Drill each pilot hole to 5.5mm diameter with a 5.5mm drill bit.

Deburr and clean the three holes for painting, paint the three holes with a primer and then touch-up paint.

Using compressed air or a vacuum cleaner thoroughly clean-up all aluminium swarf / filings from the windshield.

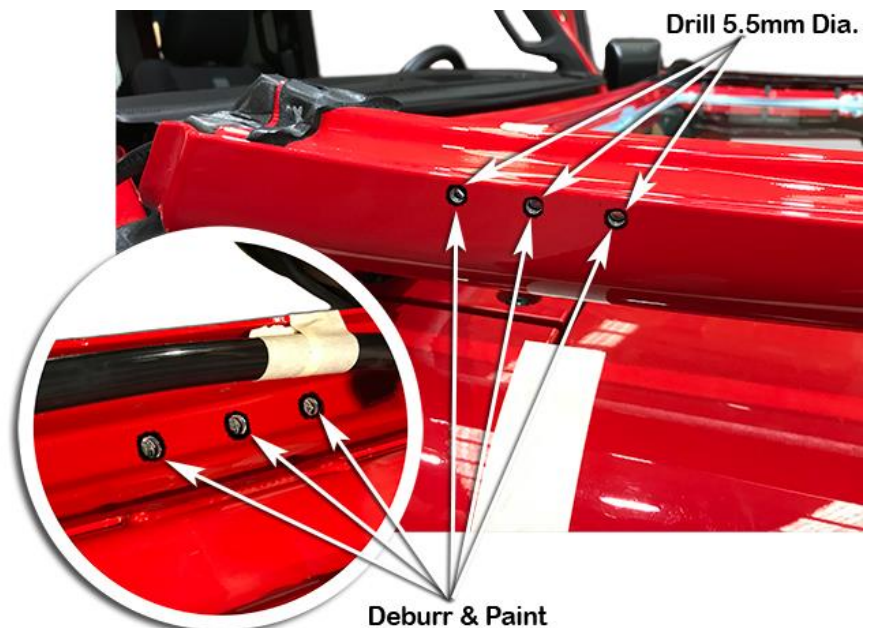

Install the three M5 x 20mm Torx bolts (item 8) through the upper mounting bracket (item 3), install the bracket gasket (item 11) to the bracket and install the bracket to the windshield frame.

Secure the bracket to the windshield frame with M5 flat washers (item 9) and M5 nyloc nuts (item 10).

Remove the masking tape from the windshield and un-tape the drain tube.



Re-install the windshield back into position and secure as per the Jeep instruction booklet.

Shape the 110/130mm hose clamp (item 28) to the oval shape of the air entry hose.

Loosely install the clamp onto the air entry hose (item 15).

Note: The orientation of the hose clamp on the air entry hose.



Carefully reinstall the snorkel body (Item 1) to the fender, guiding the snorkel body outlet into the air entry hose (item 15), align the mounting brackets to the fender mounting holes and install the standard fender bolts.

Carefully lower the hood checking the clearance between the hood bezel and the snorkel body outlet, if required loosen the fender bolts or snorkel body mounting bolts and adjust the snorkel to gain an even gap front to rear between the hood bezel and snorkel body outlet.

When correctly aligned, fasten the fender bolts or snorkel body mounting bracket bolts.

Secure the snorkel body to the upper mounting bracket (item 3) with M6 x 12mm Torx bolts (item 7).

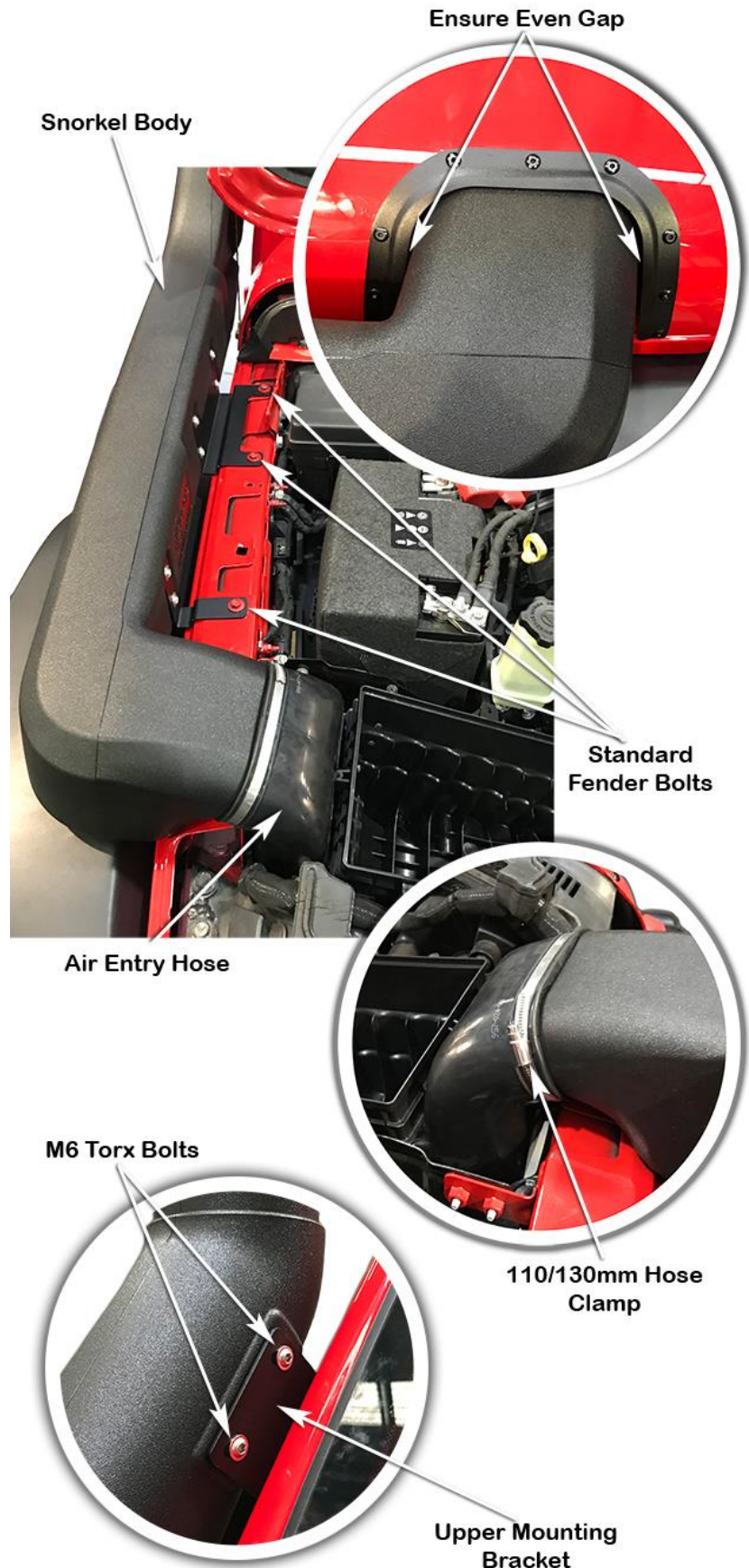

Apply masking tape to the top left hand front corner of the air ram assembly (item 2).

Measure and mark a line 38mm in from the centre border and back 13mm and 32mm from the front border of the air ram assembly as shown.

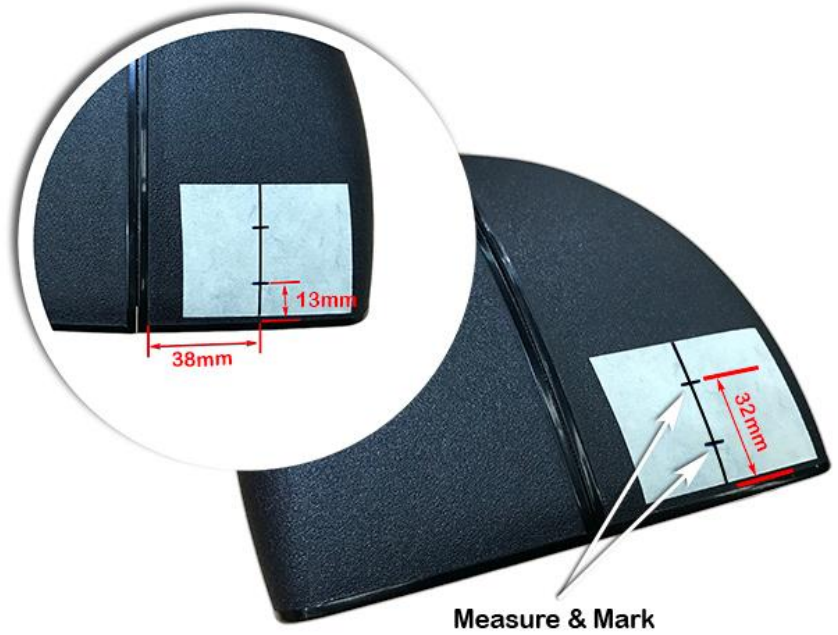

Using a 4.5mm drill bit, drill the two marked hole positions to 4.5mm diameter.

Deburr holes.



Align the antenna mounting clip (item 26) to the two 4.5mm holes drilled in the top of the air ram assembly, install two 4mm x 13mm black pop rivets (item 27), install a M4 body washer (item 22) to each of the pop rivets as shown.

Using a pop rivet gun secure the antenna mounting clip to the air ram assembly.



Loosely install the black hose clamp (Item 29) over the base of the air ram assembly (Item 2).

Install the air ram assembly onto the snorkel body, firstly clipping the thinner top part of the antenna into the antenna mounting clip and then lowering the air ram assembly down and onto the snorkel body inlet.

Align the air ram assembly and tighten the black hose clamp (Item 29).



Install the Air Cleaner Element, Air Cleaner Lid, Hood Liner and any other items that may have been removed during the snorkel installation process.

N.B: It is the installer's responsibility to ensure that all connections are watertight.



DO NOT SCALE

SCALE	SHEET	SIZE
1:1	1 of 1	A4

SAFARI
4X4 ENGINEERING
73 MERRINDALE DVE
CROYDON, VIC 3136
AUSTRALIA
PH: +61 3 9761 7244
FAX: +61 3 97617665

DESCRIPTION:-
**Template
Hacksaw Blade Modification
JL Wrangler**