



# SS1065HF

Jeep JK Wrangler (Right Hand Drive)  
2.8L CRD 4cyl Diesel



## Parts List

ITEM	PART NO.	DESCRIPTION	QTY
1	956-133-000	BODY - SNORKEL (SS1065HF)	1
2	000-135-800	3 1/2" AIR RAM ASSEMBLY	1
3	956-032-000	BRACKET - UPPER MOUNTING	1
4	000-002-100	BOLT - HEX - 6mm x 1.0 x 14mm (SEMS)	3
5	956-992-000	SPACER - PLASTIC 8.7mmID x 18mmOD x 4.5mm	2
6	000-958	POP RIVET - 4 x 12mm	4
7	000-110	STUD - S/S - 8mm x 1.25 x 25mm	3
8	000-377	WASHER - RUBBER - 8.5mm x 42mm	3
9	000-349-300	WASHER - BODY - 8mm x 40mm S/S	3
10	000-205-300	NUT - NYLOC - 8mm x 1.25mm S/S	3
11	956-024-000	HOSE - AIR ENTRY	1
12	000-909	CLAMP - HOSE - 80/100mm	2
13	956-123-000	DUCT - AIR ENTRY (SS1065HF)	1
14	000-226	CLIP - SPIRE - 4.8 x 2.5/3.7mm	3
15	000-268	NUT - TUBE - INNER GUARD	1
16	956-435-000	RUBBER PAD - 25mm x 40mm x 4.5mm (Self Adhesive)	1
17	000-951-550	SCREW - S/T - 4.8mm x 16mm (BLACK)	3
18	000-987-178	TIE STRAP - PLASTIC 4.5mm x 178mm	1
19	000-914/B	CLAMP - HOSE - No. 56 (BLACK)	1
20	956-016-000	GASKET - FOAM BODY (Self Adhesive)	1
21	956-017-000	TEMPLATE - OUTER GUARD	1
22	956-017-200	TEMPLATE - INNER GUARD	1
23	000-441-200	SLEEVE - AIR RAM	1



# SS1065HF

Jeep JK Wrangler (Right Hand Drive)  
2.8L CRD 4cyl Diesel

## Installation Guide

### Fitment to:

- Right Hand Side

### Fitting Time:

- 180min

### Special Tools:

- Body Saw (Reciprocating)
- Sikaflex 227 (adhesive sealant)
- Loctite 243 (thread lock)
- Clip Removing Tool
- 12/18" Adjustable Wrench
- Sharp Knife
- Touch-up paint
- Prep-wash
- Step Drill
- T40 Torx Bit
- Pop Rivet Gun

**Prior to commencing the installation, it is the installer's responsibility to verify that all components and particularly the template (Item's 21 & 22) are correct.**

1

Jack the vehicle up and remove the right hand front wheel.

2

Remove the RHS inner guard liner. (The 3 rear plastic pop rivets must be removed as shown).



Remove Plastic Pop Rivets

3

Remove the following in accordance with the factory service manual:

- Radio antenna
- Air cleaner assembly

4

Remove and discard the:

- Air intake from the air cleaner housing
- "Sport" sticker from the RHS guard. (Use prep wash to remove any sticky residue from the sticker).

Remove And Discard



5

Tape the outer guard template (item 21) to the rear and upper edges of the right hand guard. Using a felt tip pen, mark the 3 hole positions and the required guard panel and flare cut out area. Remove the template.



6

Position the inner guard template (item 22) over the 2 flare clips. Using a felt tip pen, mark the required guard panel area which needs to be removed.

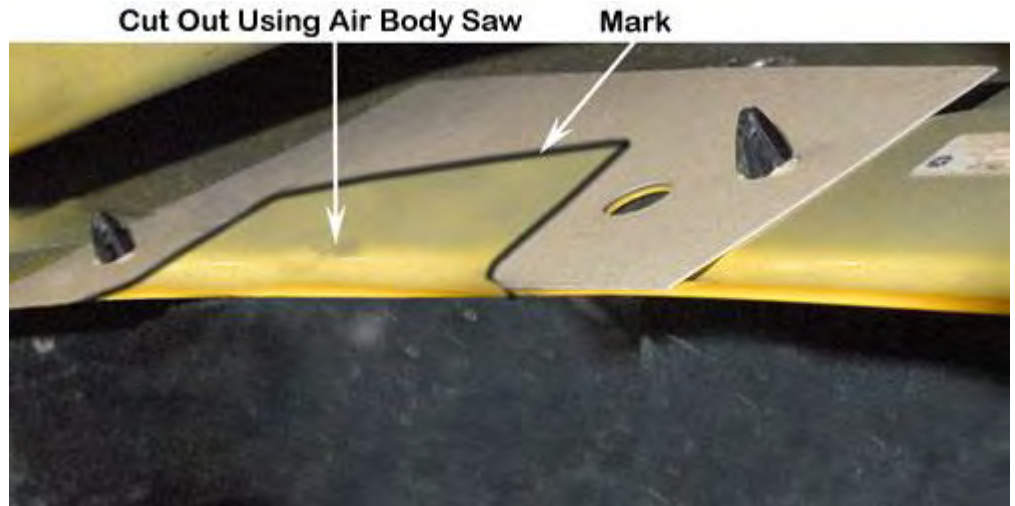

7

Using the body saw, remove the marked area of the inner guard panel, outer guard panel and flare. Drill a pilot hole for the 3 marked mounting hole positions. Using the step drill, drill the 3 mounting hole positions to 16mm. De burr and paint all the exposed metal surfaces to prevent rust.



8

Using a 12" or 18" adjustable wrench or specialized panel beating equipment, bend the lower "A" Pillar reinforcement panel inwards (Be sure to bend the panel far enough inwards). This process is critical to ensure that adequate clearance is achieved for the fitment of the air entry hose (Item 11). Prepare the surface and paint to prevent the panel from rusting.



9

**Prior to installing the snorkel body to the guard panel:** Check for clearance between the guard panel and main structure where the main section of guard panel is spot welded to the upper panel as shown.

The joined section of guard panel **must** have 1.0mm+ minimum clearance to the main structure, if there is less than 1.0mm or no clearance between the guard panel and main structure, adjustments to achieve the required clearance is necessary.



10

**The following steps need to be followed to achieve the required clearance:**

Remove the windscreen support bracket and gently pull the top of the guard panel outwards at the joined section until 1.0mm+ clearance is achieved.

Remove the backing paper from the double sided tape on the rubber pad (item 16) and install the rubber pad between the lip of the guard panel and main structure as shown.

*Hint: Loosening the rear guard mounting bolt will allow easier installation of the rubber pad.*

Re-install the windscreen support bracket and re-check the clearance between the guard panel and main structure, it may be necessary to make more adjustment to achieve the required clearance of 1.0mm+.

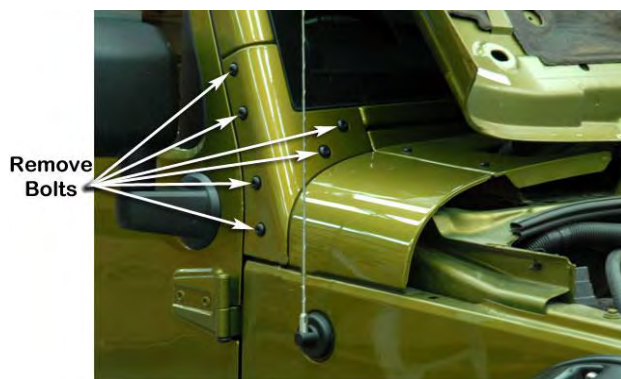

11

Remove the two standard bolts from the 'A' Pillar and install the two plastic spacers (Item 5) into the two 'A' Pillar bolt reliefs.

Apply Loctite 243 to the two standard 'A' Pillar bolts and install the upper mounting bracket (Item 3) to the 'A' Pillar.

Fasten the bolts in accordance with the factory service manual.

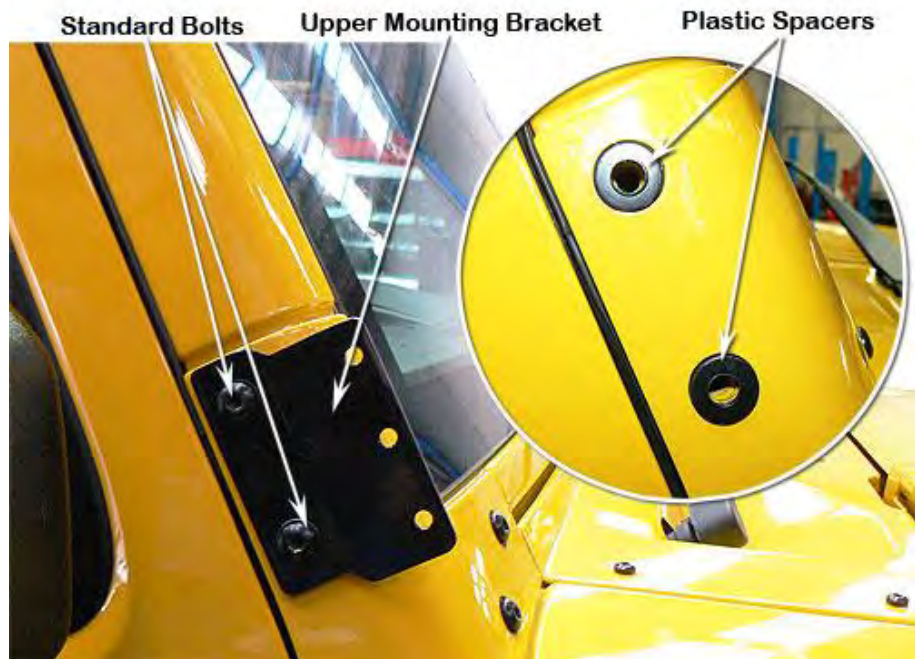

12

Apply Loctite 243 to each of the stainless steel mounting studs (Item 7) and install the studs finger tight into the snorkel body (Item 1) mounting inserts.

Remove the adhesive backing paper from the foam body gasket (Item 20). Carefully align the foam body gasket to the back of the snorkel body (Item 1), When correctly positioned, apply firm pressure all over the foam body gasket to adhere the foam body gasket to the snorkel body.

Mark and cut a neat drain slot in the foam body gasket (item 20) with a sharp knife, to allow water to drain from the aerial relief.

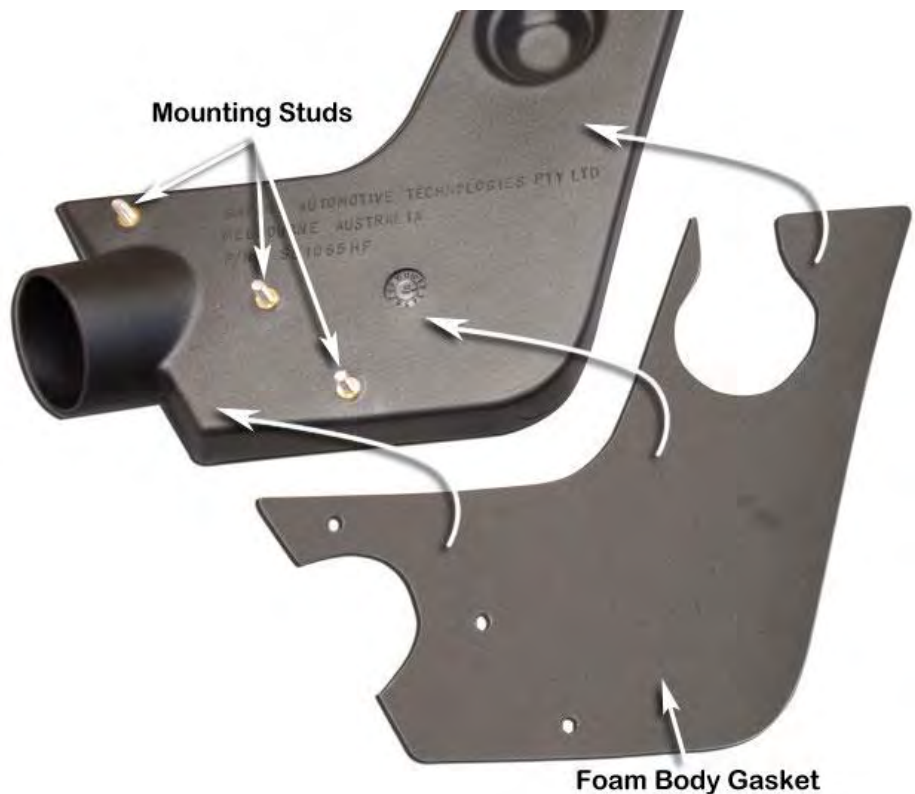

13

Measure 65mm down from the top of the snorkel body and mark the circumference.

Slide the air ram sleeve (Item 23) over the top of the snorkel body (Item 1) and align the bottom of the sleeve with the 65mm mark. Lift the edges of the sleeve (Item 23) and apply several small dabs of Loctite 406 Instant Adhesive or similar to secure the sleeve in position.



14

Install the snorkel body onto the guard panel.

Align the snorkel body to the upper mounting bracket and guard panel. When correctly aligned, check for clearance around each of the 8mm mounting studs and the snorkel body brass inserts, the mounting studs and brass inserts **must** have clearance to the 16mm diameter holes in the guard panel, if necessary remove the snorkel body and enlarge each of the holes to ensure the mounting studs and brass inserts have adequate clearance to the guard panel.

15

With the required clearance around each of the mounting studs and brass inserts fasten the snorkel body to the guard panel with rubber washer (item 8), body washers (Item 9) and nyloc nuts (Item 10).

Fasten the snorkel body to the upper mounting bracket with hex bolts (Item 4).



16

Unclip the wiring harness from its mounting position. Mark down 80mm from the top of the air cleaner housing mounting bracket as shown. Using the body saw cut away the required section of the air cleaner housing mounting bracket. Use a file to smooth off any sections of the plastic bracket which require deburring. Touch up any areas of paint which may have been damaged or scratched during the bracket cutting process.

Re-clip the wiring harness back into its original position.

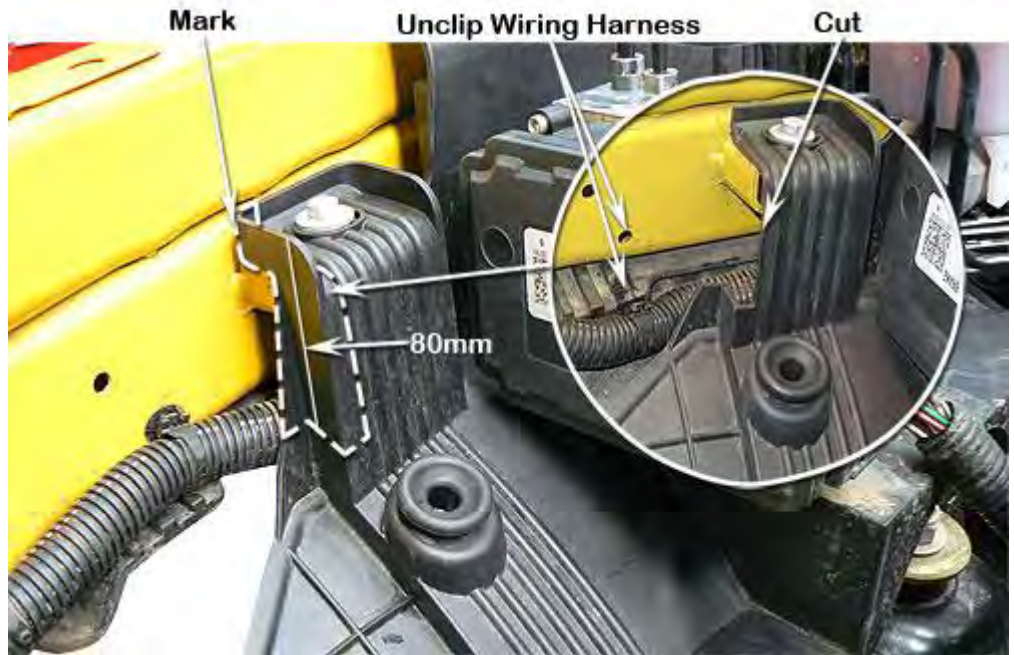

17

Using a sharp knife, trim the 2 air cleaner housing outer ribs back to a length of approximately 10mm. Completely remove the 3 inner ribs (as shown), measure down 18mm and across 11mm from the centre rib position, drill a 4.2mm diameter hole at the required position.

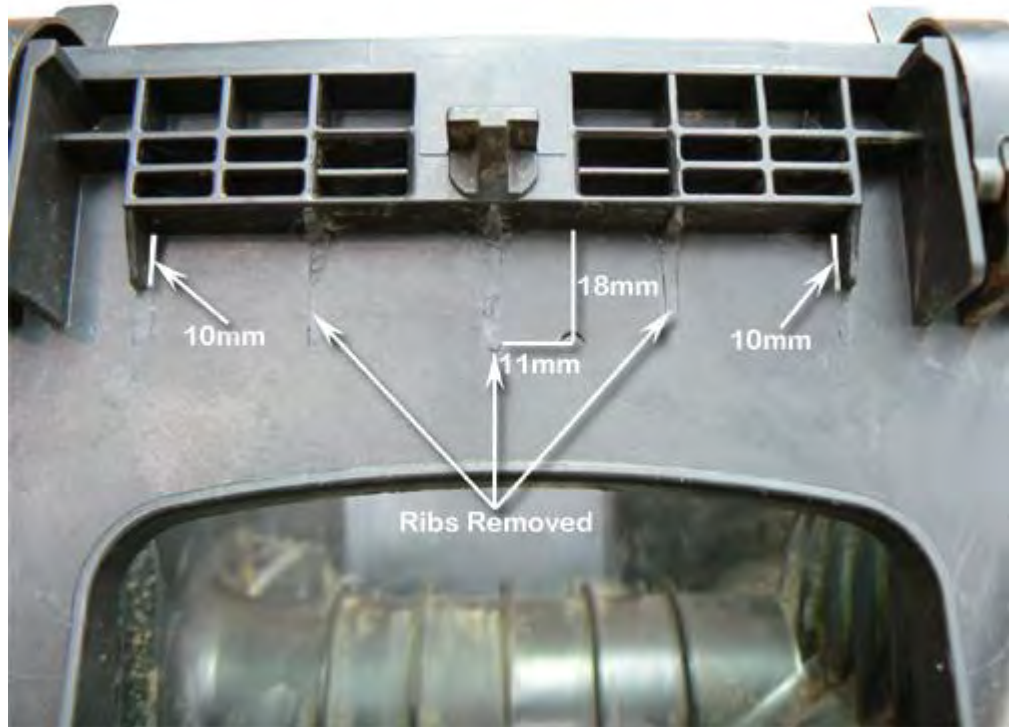



18

Position the air entry duct (Item 13) onto the air cleaner housing. Mark the 3 required hole positions through the air entry duct onto the air cleaner housing. Mark through the drilled hole in the air cleaner housing onto the air entry duct. Remove the air entry duct and drill the marked hole position to 4.2mm diameter. Drill the 3 marked hole positions on the air cleaner housing to 4.2mm diameter.

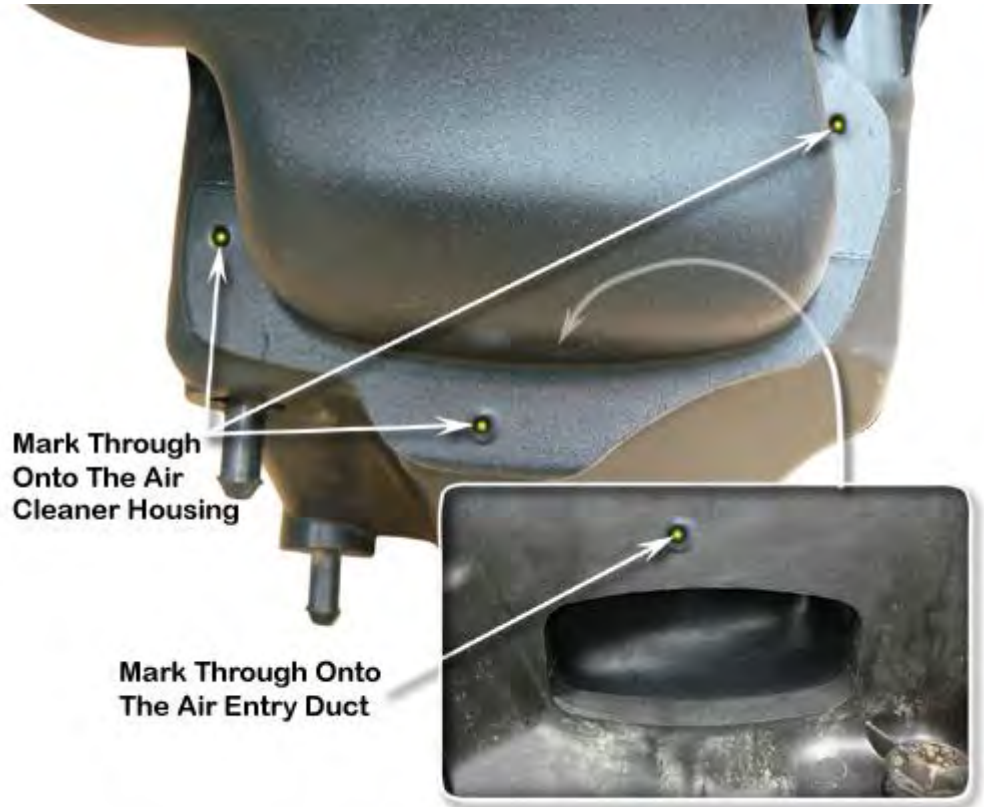

19

Apply a generous amount of sikaflex sealant to the air entry duct (Item 13) flange and around the outside surface of the air cleaner housing inlet snout. Position the air entry duct onto the air cleaner housing and secure using 4mm x 12mm pop rivets (Item 6). Clean up any excessive sikaflex sealant to ensure a neat job.



20

Using sikaflex sealant, totally seal off the 3 air cleaner housing mounting pin positions (as shown). Other possible areas for water to enter the engine air intake are through the drain holes in the air cleaner housing.

It is up to the installer to determine whether the drains should be totally sealed off to prevent water from entering the air intake when the vehicle is immersed to that depth.



21

Install the air entry hose (Item 11) into position, loosely install a 80/100mm hose clamp (item 12) at either end of the air entry hose, position the air entry hose onto the snorkel body outlet snout.

22

Reinstall the modified air cleaner base/air entry duct assembly into position, ensure the air cleaner base pins locate correctly into the rubber mounting bushes.

23

With the air cleaner base assembly correctly reinstall. Install the air entry hose (Item 11) onto the air entry duct (Item 13). Orientate the hose to achieve the best alignment at either end, tighten the 80/100mm hose clamps (item 12) at both ends of the air entry hose. Check that the air entry hose has clearance to the brake lines and steering column, if required make adjustments to the hose fitment to achieve required clearance.



24

The air entry duct (item 13) **must** have adequate clearance to following:

- Air Cleaner Mounting Bracket
- Brake Lines
- Body Work

25

Reinstall the air filter element, air cleaner housing top and connect both sensor plugs.

26

Install 3 spire clips (Item 14) to the 3 rear inner guard liner holes.

Reinstall the inner guard liner, secure with standard clips, 3 self tapping screws (Item 17) and tube nut (item 15).

Mark and drill a 4.5mm hole into the shocker tower and with a small file, elongate the hole for the plastic tie strap.

Deburr and paint the hole to prevent rust.

Mark and drill a 4.5mm hole through the inner guard liner as shown.

Install the plastic tie strap (Item 18) through the 4.5mm holes.

Refit the right front wheel, radio antenna and any other components that may have been removed during the installation process.

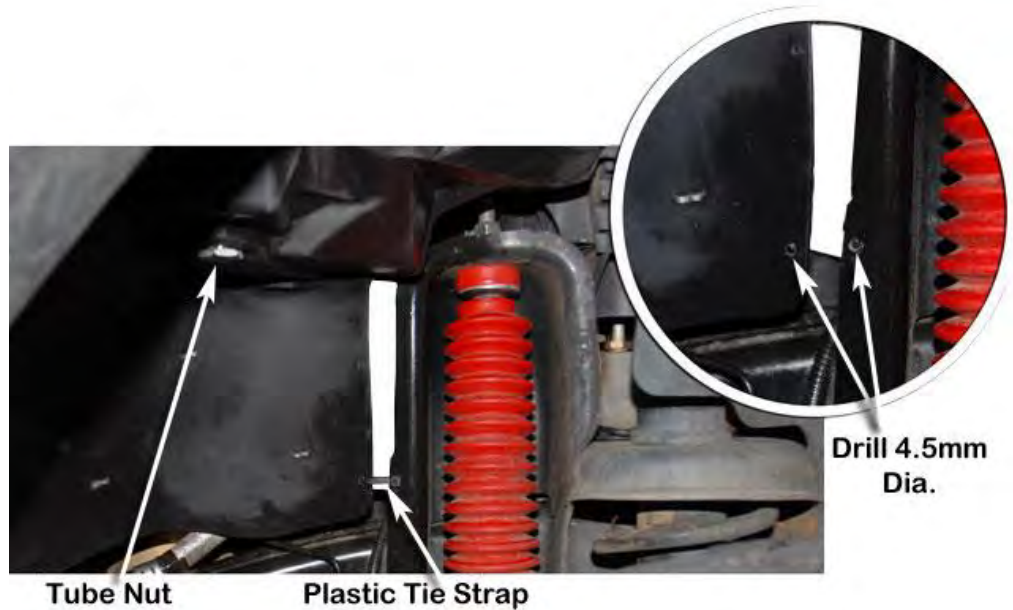

27

Loosely install the black hose clamp (Item 19) to the base of the air ram assembly (Item 2). Install the air ram assembly onto the snorkel body. Align the air ram assembly and tighten the black hose clamp (Item 19).



28

**N.B: It is the installer's responsibility to ensure that all connections are watertight.**