



SS1060HF

Jeep JK Wrangler
3.8 Litre-V6 Petrol Engine
Right Hand Drive Vehicle Fitment Only



20/05/2008

ITEM	DESCRIPTION	QTY	PART NO
1	BODY - SNORKEL (SS1065HF)	1	956-133-000
2	3 1/2" AIR RAM ASSEMBLY	1	000-135-650
3	BRACKET - UPPER MOUNTING	1	956-032-000
4	BOLT - HEX - 6mm x 1.0 x 14mm (SEMS)	3	000-002-100
5	SPACER - PLASTIC 8.7mmID x 18mm x 4.5mm	2	956-992-000
6	POP RIVET - 4 x 12mm	4	000-958
7	STUD - S/S - 8mm x 1.25 x 25mm	3	000-110
8	WASHER - BODY - 8mm x 30mm	3	000-311
9	NUT - NYLOC - 8mm x 1.25mm	3	000-205
10	HOSE - AIR ENTRY	1	956-024-000
11	CLAMP - HOSE - 80/100mm	2	000-909
12	DUCT - AIR ENTRY (SS1065HF)	1	956-123-000
13	CLIP - SPIRE - 4.8 x 2.5/3.7mm	3	000-226
14	SCREW - S/T - 4.8mm x 16mm (BLACK)	3	000-951-550
15	BRACKET - PURGE VALVE RELOCATION	1	956-089-000
16	BOLT - HEX - 6mm x 20mm (SEMS)	1	000-003-100
17	HOSE - 5/16" ID x 200mm	1	000-1863-020
18	HOSE - 3/8" ID x 280mm	1	000-1864-028
19	CLAMP - NO. 14	1	000-911-014
20	CLAMP - NO. 17	1	000-911-017
21	TIE STRAP - NYLON - 4.8mm x 178mm	1	000-987-178
22	CLAMP - HOSE - No. 56 (BLACK)	1	000-914/B
23	TEMPLATE - OUTER GUARD	1	956-017-000
24	TEMPLATE - INNER GUARD	1	956-017-200

Manufactured by Safari Automotive Technologies Pty Ltd

73 Merrindale Drive, South Croydon Victoria 3136 Australia Tel: +61 3 9761 7244 Fax: +61 3 9761 7665

www.safarisnorkel.com

ABN 88 071 262 756



SS1060HF

Jeep JK Wrangler
3.8 Litre-V6 Petrol Engine
Right Hand Drive Vehicle Fitment Only

Installation Guide

1

Fitment to:

- Right Hand Side

Fitting Time:

- 180 min

Special Tools:

- Air Body Saw
- Step Drill
- T40 Torx Bit
- Pop-Rivet Gun
- Touch-up Paint
- Sikaflex 227 (adhesive sealant)
- Loctite (thread lock)
- Clip Removing Tool
- 12/18" Adjustable Wrench
- Prep Wash
- Sharp Knife

Prior to commencing the installation, it is the installer's responsibility to verify that all components and particularly the templates (Item 23 & 24) are correct.

2 Jack the vehicle up and remove the right hand front wheel.

3

Remove the RHS inner guard liner. (The 3 rear plastic pop rivets must be removed as shown).



Remove Plastic Pop Rivets

4 Remove the following in accordance with the factory service manual:

- Radio antenna
- Air cleaner assembly
- A-Pillar bolts x 2

5

Disconnect the wiring plug, the two plastic hose connectors and remove the purge valve for relocation as shown.

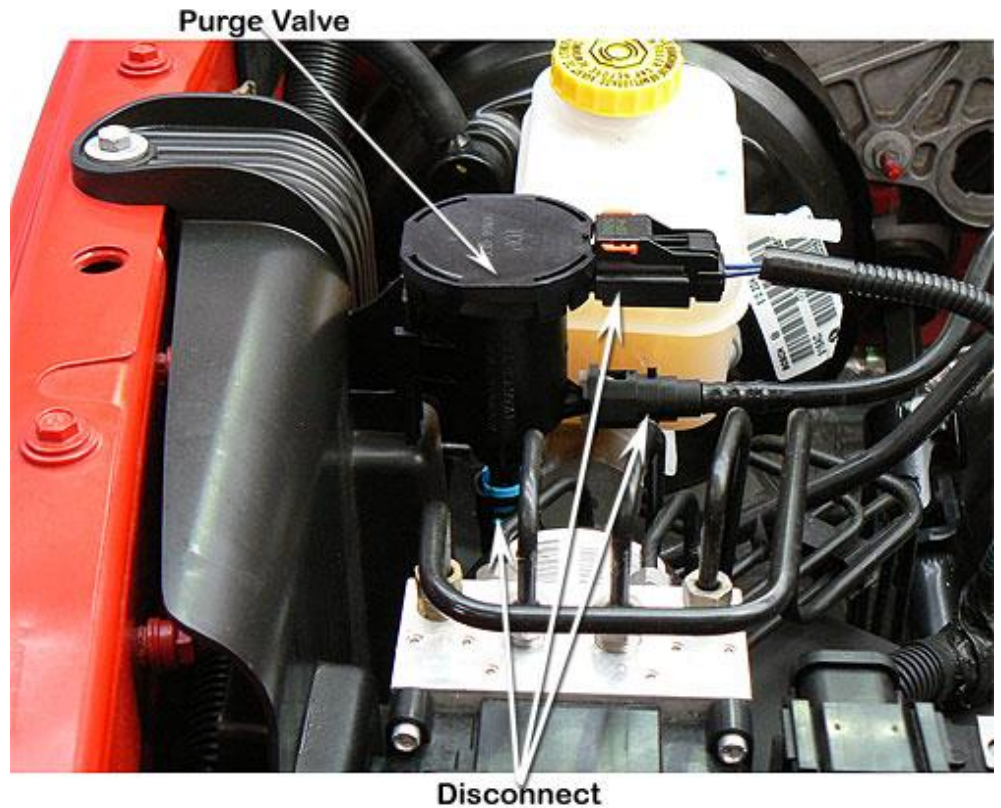

6

Remove and discard the:

- Air intake from the air cleaner housing
- "Sport" sticker from the RHS guard. (Use prep wash to remove any sticky residue from the sticker).

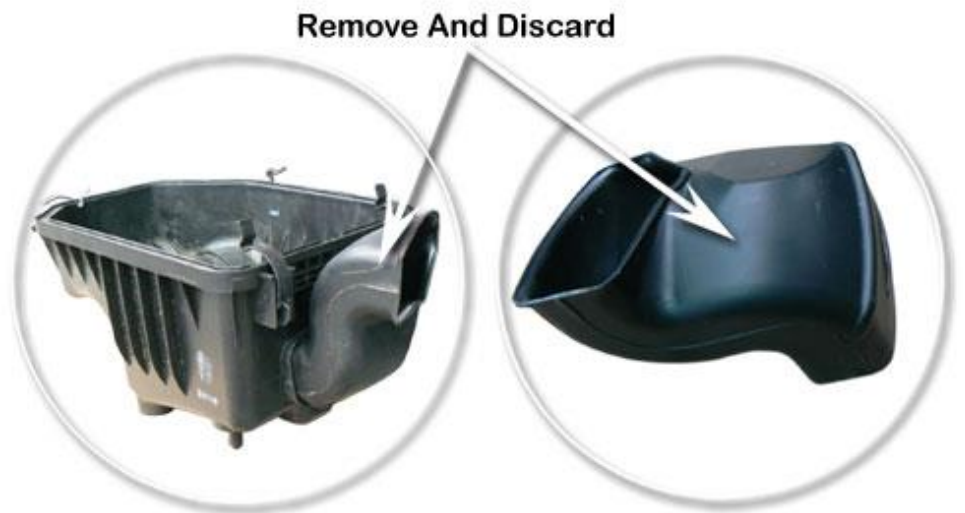

7

Tape the outer guard template (Item 23) to the rear and upper edges of the right hand guard. Using a felt tip pen, mark the 3 hole positions and the required guard panel and flare cut out area. Remove the template.

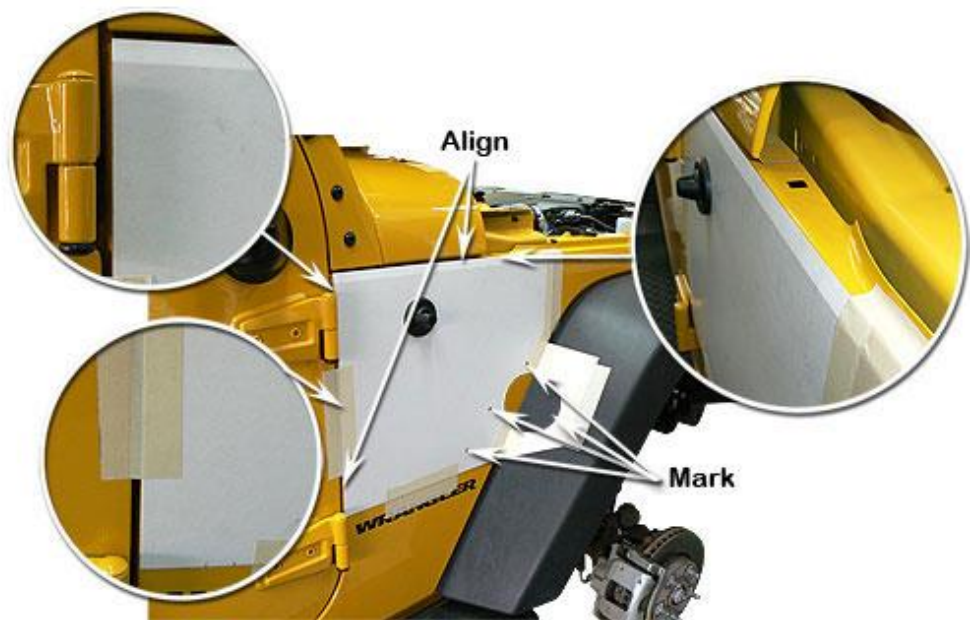

8

Position the inner guard template (Item 24) over the 2 flare clips. Using a felt tip pen, mark the required guard panel area which needs to be removed.

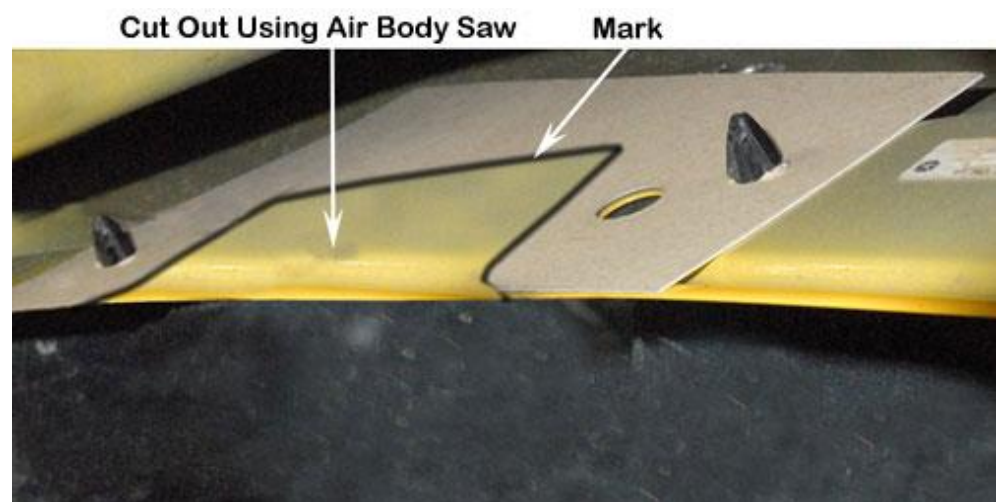

9

Using the air body saw, remove the marked area of the inner guard panel, outer guard panel and flare. Drill a pilot hole for the 3 marked mounting hole positions. Using the step drill, drill the 3 mounting hole positions to 16mm. De burr and paint all the exposed metal surfaces to prevent rust.



10 Using a 12" or 18" adjustable wrench or specialized panel beating equipment, bend the lower "A" Pillar reinforcement panel inwards (Be sure to bend the panel far enough inwards). This process is critical to ensure that adequate clearance is achieved for the fitment of the air entry hose (Item 10). Prepare the surface and paint to prevent the panel from rusting.

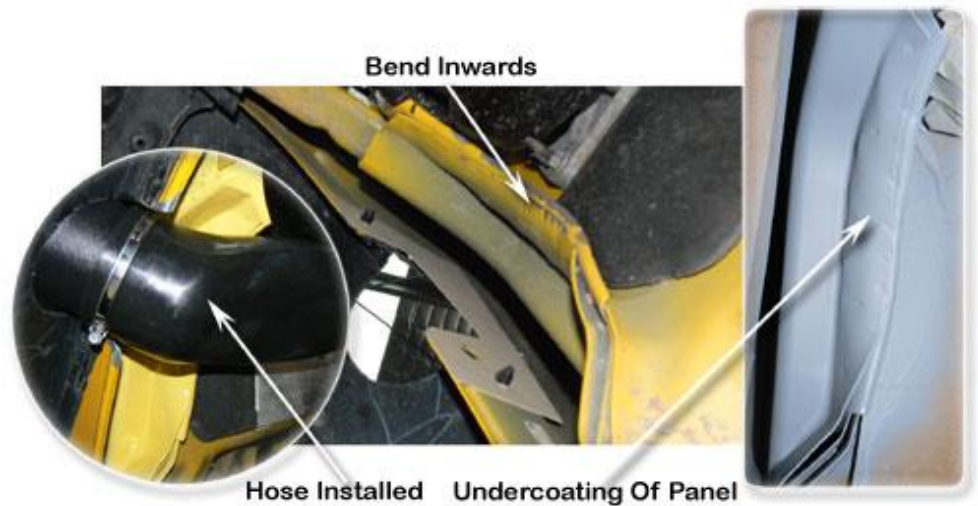

11 Unclip the wiring harness from its mounting position. Mark down 80mm from the top of the air cleaner housing mounting bracket as shown. Using the air body saw cut away the required section of the air cleaner housing mounting bracket. Use a file to smooth off any sections of the plastic bracket which require deburring. Touch up any areas of paint which may have been damaged or scratched during the bracket cutting process. Re-clip the wiring harness back into its original position.

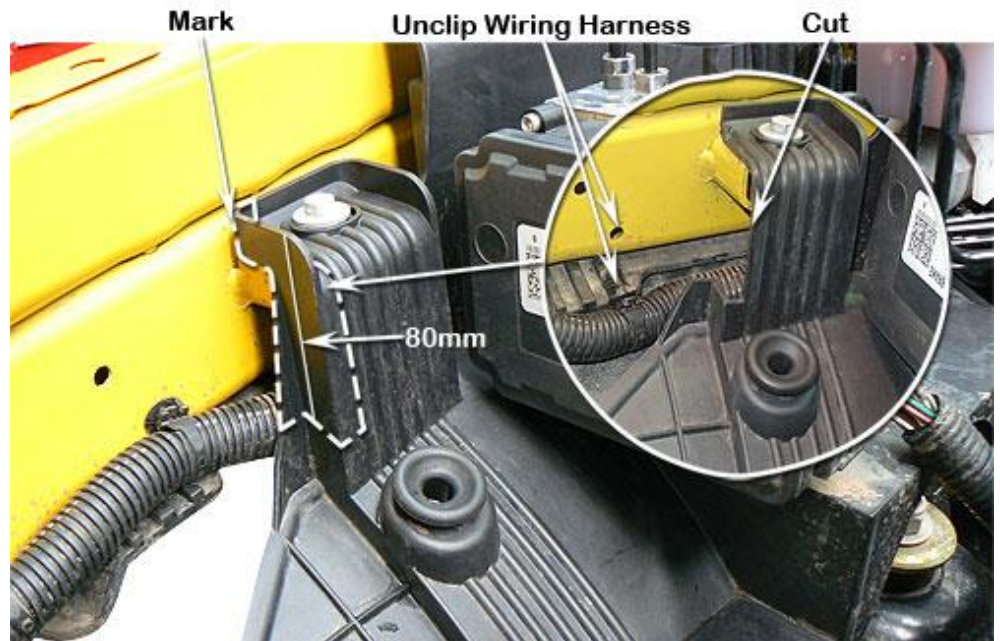

12

Using a sharp knife, trim the 2 air cleaner housing outer ribs back to a length of approximately 10mm. Completely remove the 3 inner ribs (as shown), measure down. 18mm and across 11mm from the centre rib position, drill a 4.2mm diameter hole at the required position.

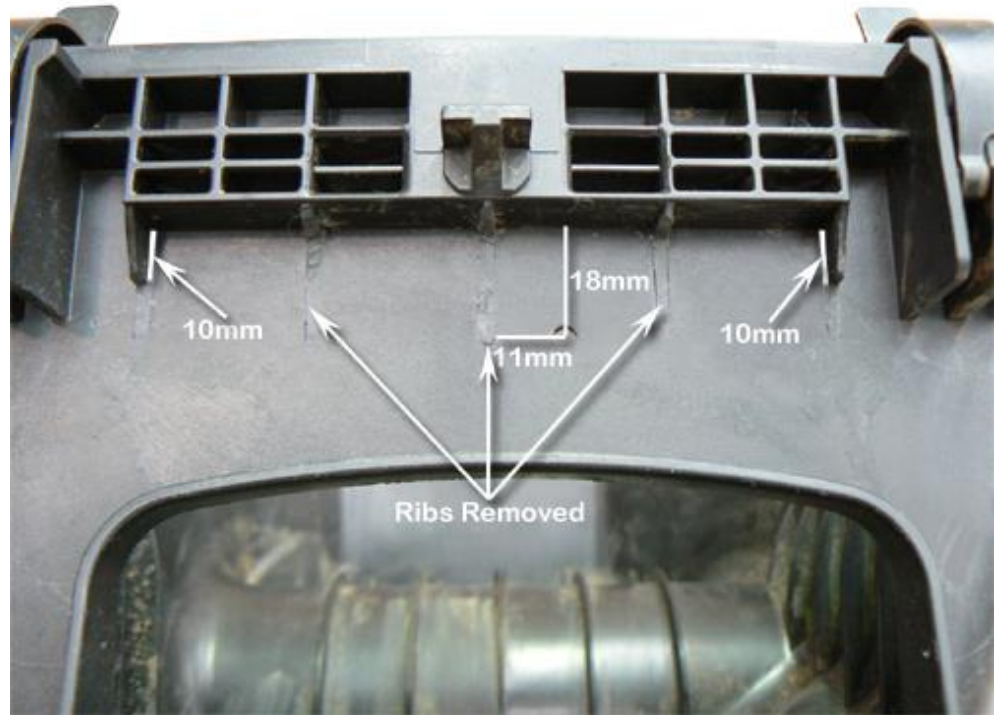

13

Position the air entry duct (Item 12) onto the air cleaner housing. Mark the 3 required hole positions through the air entry duct onto the air cleaner housing. Mark through the drilled hole in the air cleaner housing onto the air entry duct. Remove the air entry duct and drill the marked hole position to 4.2mm diameter, drill the 3 marked hole positions on the air cleaner housing to 4.2mm diameter.

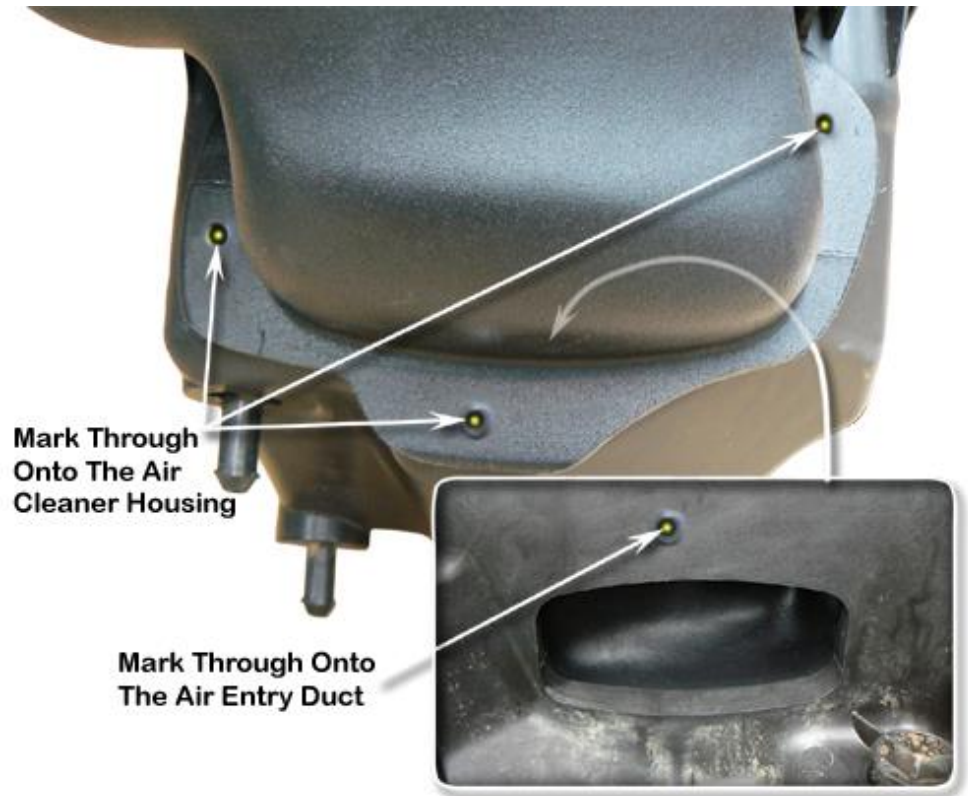

Apply a generous amount of sikaflex sealant to the air entry duct (Item 12) flange and around the outside surface of the air cleaner housing inlet snout. Position the air entry duct onto the air cleaner housing and secure using 4mm x 12mm pop rivets (Item 6). Clean up any excessive sikaflex sealant to ensure a neat job.

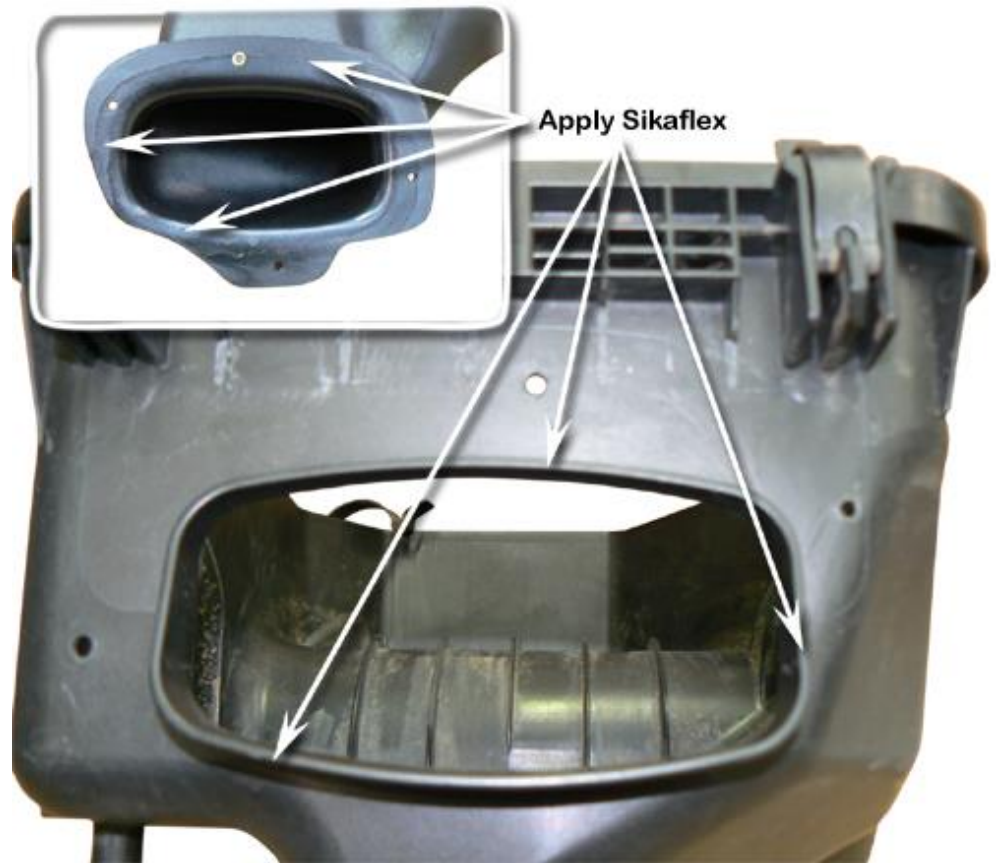

Using sikaflex sealant, totally seal off the 3 air cleaner housing mounting pin positions (as shown). Other possible areas for water to enter the engine air intake is through the drain hole in the air cleaner housing.

It is up to the installer to determine whether the drain should be totally sealed off to prevent water from entering the air intake when the vehicle is immersed to that depth.

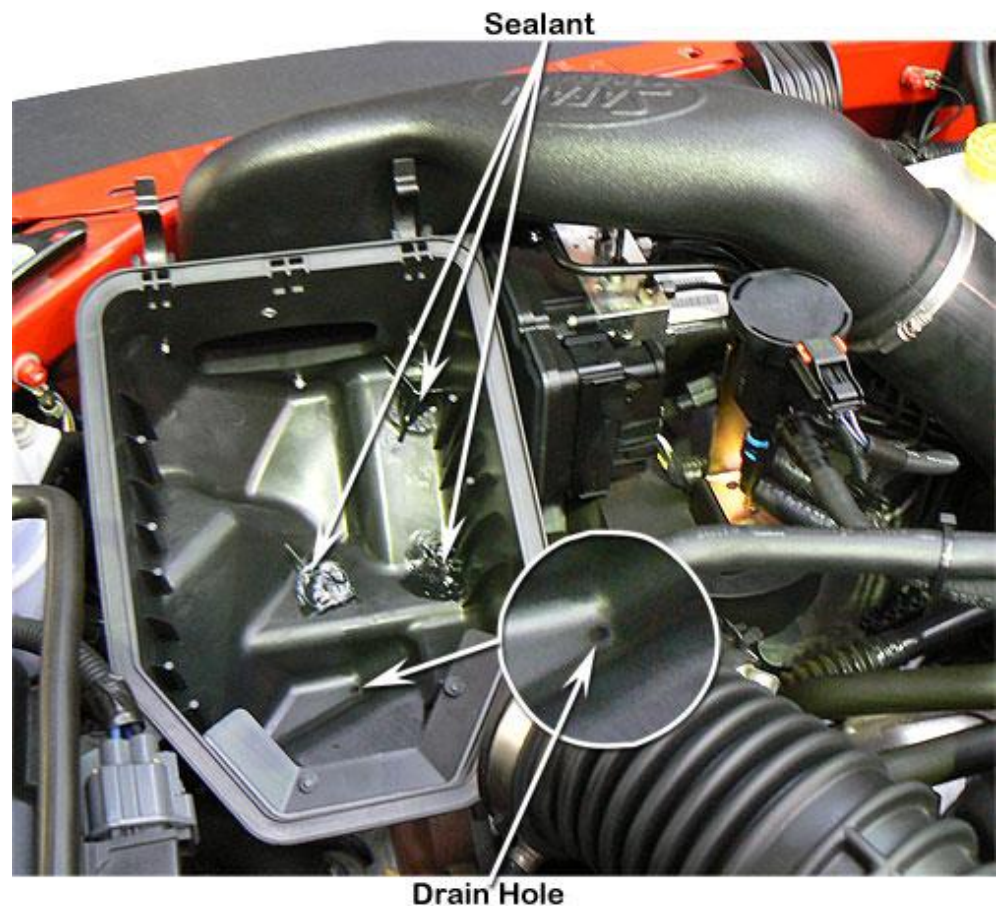

16

Install the two plastic spacers (Item 5) into the two 'A' Pillar bolt reliefs, apply loctite to the two standard 'A' Pillar bolts and install the upper mounting bracket (Item 3) onto the 'A' Pillar, fasten bolts to the required torque setting.

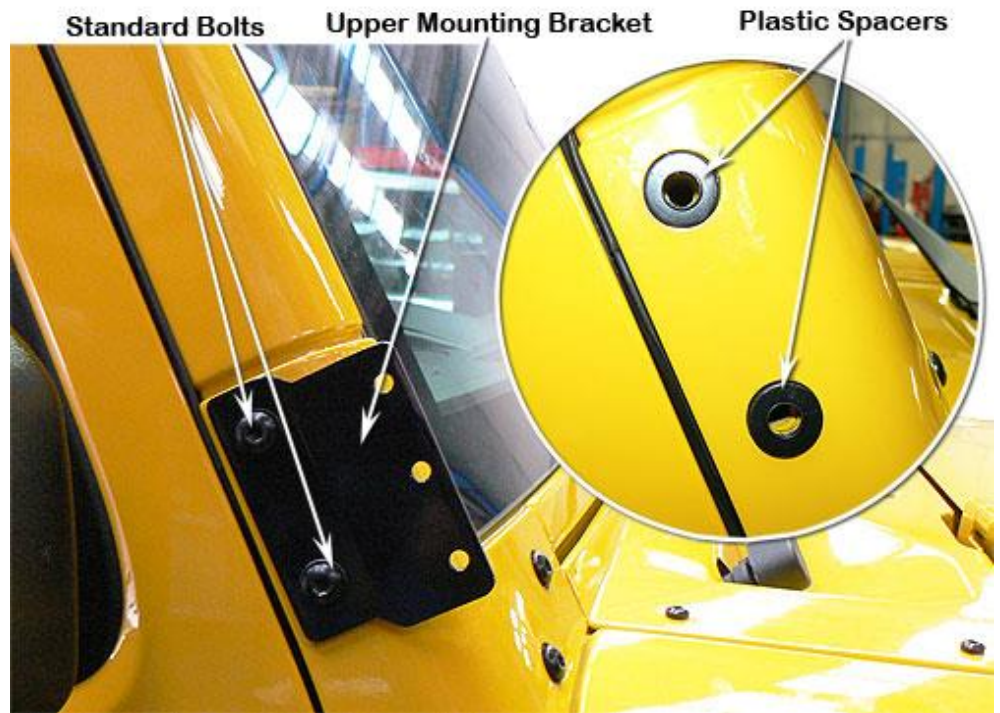

17

Install the snorkel body onto the guard. Align the snorkel body to the upper mounting bracket and guard panel. When correctly aligned, fasten the snorkel body to the guard panel with body washers (Item 8) and nyloc nut (Item 9). Fasten the snorkel body to the upper mounting bracket with hex bolts (Item 4).



18 Install the air entry hose (Item 10) into position, loosely install a 80/100mm hose clamp at either end of the air entry hose, position the air entry hose onto the snorkel body outlet snout.

19 Reinstall the modified air cleaner base/air entry duct assembly into position, ensure the air cleaner base pins locate correctly into the rubber mounting bushes.

20 With the air cleaner base assembly correctly reinstall. Install the air entry hose (Item 10) onto the air entry duct (Item 12). Orientate the hose to achieve the best alignment at either end, tighten the 80/100mm hose clamps at both ends of the air entry hose. Check that the air entry hose has adequate clearance to the steering column, if required make adjustments to the hose fitment to achieve required clearance.

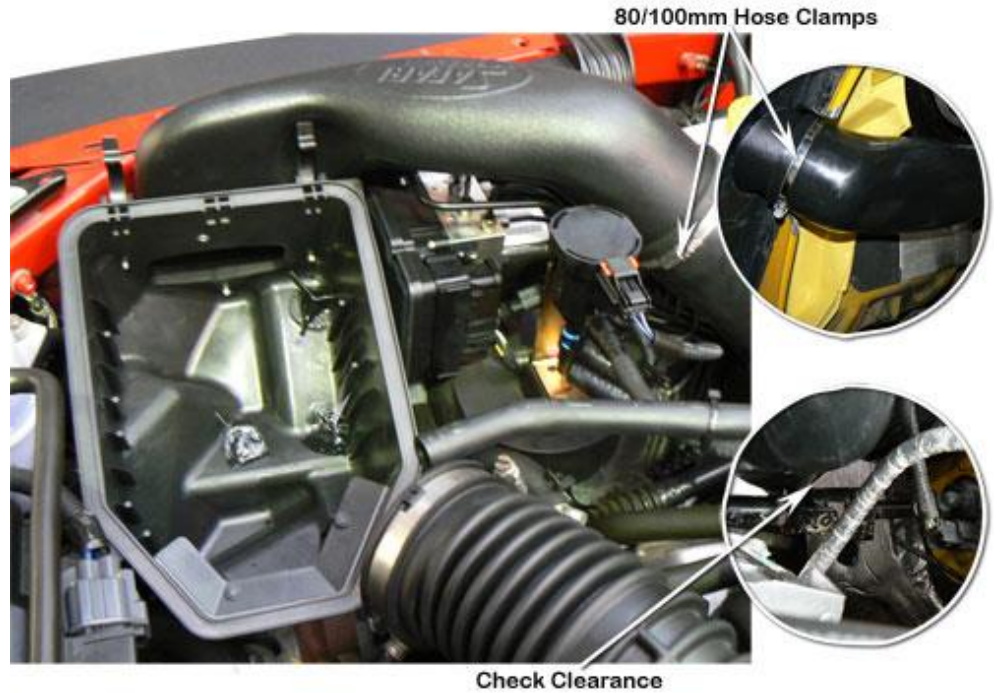

21 Using a sharp knife, cut the plastic pipe off the two plastic connectors. Install the 5/16" ID hose (Item 17) to the straight plastic connector barb; install the 3/8" ID hose (Item 18) to the 90 deg plastic connector barb. Install the purge valve relocation bracket (Item 15), fasten the bracket into position with 6mm x 20mm hex bolt (Item 16). Install the two plastic connectors to the purge valve. Reinstall the purge valve assembly as shown.

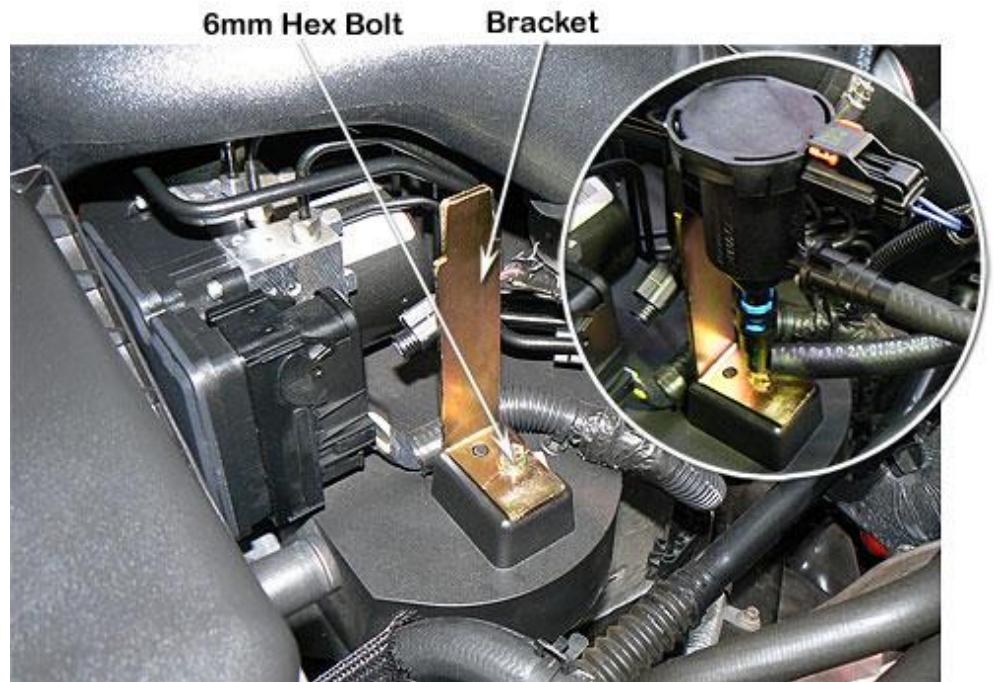

22 Position the relevant hose beside the plastic pipe and cut the pipe to length as shown, allowing the plastic pipes to be installed 30mm into the rubber hoses. Install the No: 14 clamp (Item 19) onto the 5/16" ID hose (Item 17), install the No: 17 clamp (Item 20) onto the 3/8" ID hose (Item 18). Install the relevant hoses onto the cut plastic pipes and secure with clamps.

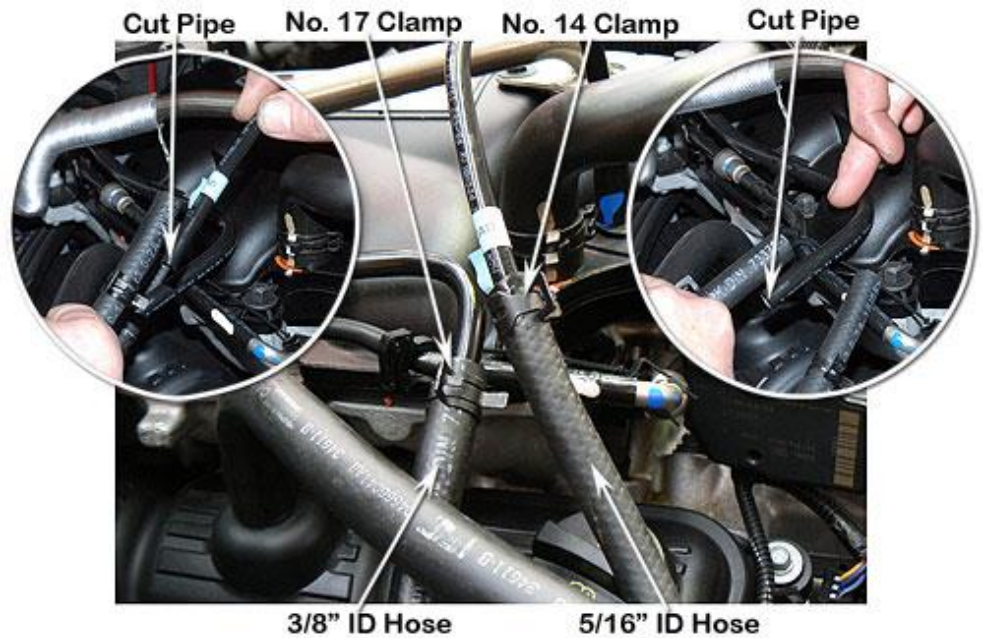

23 Reinstall the air filter element, air cleaner housing top.

24

Install 3 spire clips (Item 13) to the 3 rear inner guard liner holes.

Reinstall the inner guard liner, secure the 3 rear hole positions using self tapping screws (Item 14). Refit the right front wheel, radio antenna and any other components that may have been removed during the installation process.



Loosely install the black hose clamp (Item 22) to the base of the air ram assembly (Item 2). Install the air ram assembly onto the snorkel body. Align the air ram assembly and tighten the black hose clamp (Item 22).



Note: It is the installer's responsibility to ensure that all connections are watertight.

For an on-line colour copy of these instructions, please see:
www.safarisnorkel.com/guides/JEEP/ss1060hf/ss1060hf_guide.htm

Manufactured by Safari Automotive Technologies Pty Ltd

73 Merrindale Drive, South Croydon Victoria 3136 Australia Tel: +61 3 9761 7244 Fax: +61 3 9761 7665

www.safarisnorkel.com

ABN 88 071 262 756