

# LDV G10



TOWBAR INFORMATION

Vehicle: **LDV G10**  
 Towbar no: **T4P658**  
 Lug no: **L4120**  
 Max weight: **1500Kg**  
 Max ball load: **150Kg**

FOR TRAILER TOWING ONLY

Recommended wiring harness part number:

**Warning:**

This product is for towing purposes only and must only be loaded as shown in your vehicle Owners Manual.

This towbar is NOT to be drilled, cut, welded or modified in any way.

Check behind chassis rail and body panels before drilling to ensure no hazards are present

**General:**

Before fitting this towbar read fitting instructions and check installation hardware is correct.

Check that the towbar is suitable for the vehicle and be wary of any changes to the vehicle design that may conflict with the fitting of this towbar.

After drilling, blow any filings clear, remove any swarf and treat exposed metal with a rust inhibitor.

If this vehicle requires a bumper cut out, please check to make sure that you measure twice and check twice before cutting any panels as some bumper profiles can change.

If you are not sure then please ask your towbar supplier



## PROCESS FLOW

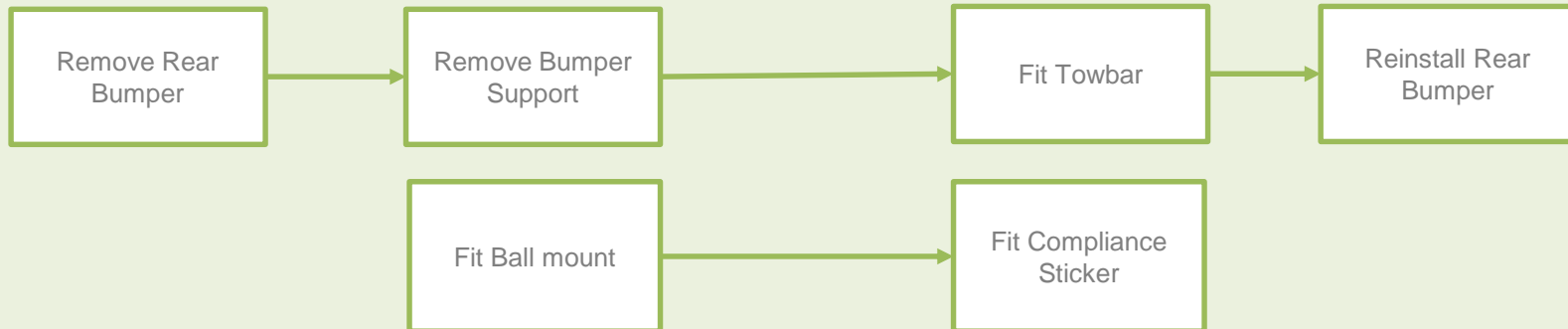

## TORQUE TABLE

METRIC GRADE 8.8	UNC GRADE 8



For safety reasons all fasteners should be tightened using a torque wrench - we recommend an adjustable torque wrench to reach the required bolt torque settings above.

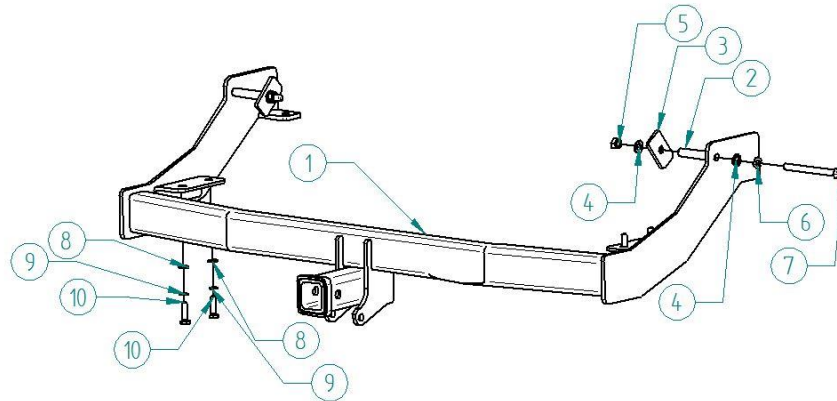

## EXPLODED DRAWING



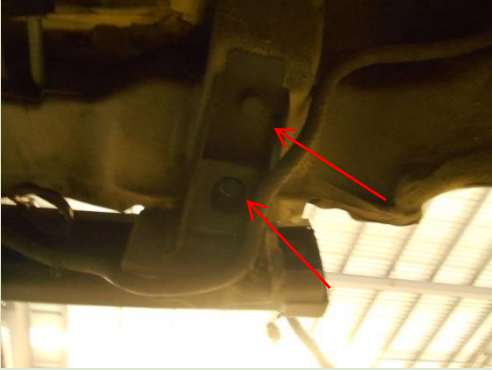

## HARDWARE KIT

NUM	ITEM	QTY
1	Towbar	1
2	Crush Tube	2
3	6mm Plate	2
4	M12 Washer	4
5	M12 Nut	2
6	M12 Shakeproof Washer	2
7	M12x130 Bolt	2
8	M10 Washer	4
9	M10 Shakeproof Washer	4
10	M10x35 Bolt	4

Step	What Important Step	Illustrations / Photo's	How / Why Explanations / Reasoning	Tools & Fasteners	
1	Remove Bumper		<p>a) Remove the two screws (one each side)</p>		
2	Remove Bumper		<p>a) Remove the three screws marked in the photo and the two screws behind the rear wheel arch.  b) Unclip all the plugs for the rear parking sensors if necessary.  c) Unclip the bumper from the sides first then pull towards the rear of the vehicle.</p>		

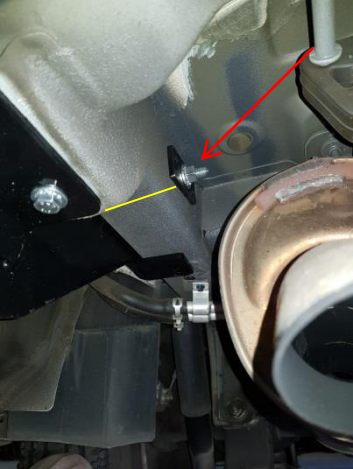
Step	What Important Step	Illustrations / Photo's	How / Why Explanations / Reasoning	Tools & Fasteners	
3	Remove Bumper Support		<ul style="list-style-type: none"> <li>a) Remove the 4 bolts both sides of the bumper support located under the car.</li> <li>b) Unclip all the pugs and remove from the bumper support and store safely.</li> <li>c) Discard bumper support as the Towbar will be mounted in this position</li> </ul>		
4	Fit Towbar		<ul style="list-style-type: none"> <li>a) Place Towbar into position and insert the four M10 Bolts into the captive nuts where the Bumper Support once was.</li> </ul>		

Step	What Important Step	Illustrations / Photo's	How / Why Explanations / Reasoning	Tools & Fasteners	
5	Fit Towbar		<ul style="list-style-type: none"> <li>a) Insert the M12 fasteners into position remembering to place the crush tube through the chassis (Yellow Line) and the 6mm Plate on the opposite side to the end plate (pictured).</li> <li>b) Tighten all Bolts.</li> </ul>		
6	Reinstall Bumper		<ul style="list-style-type: none"> <li>a) You will need to cut off the middle bumper bracket tab pictured before fitting towbar.</li> <li>b) Replace all wiring and zip tie it all to the towbar.</li> <li>c) Repeat steps on removing the rear bumper to reinstall.</li> </ul>		

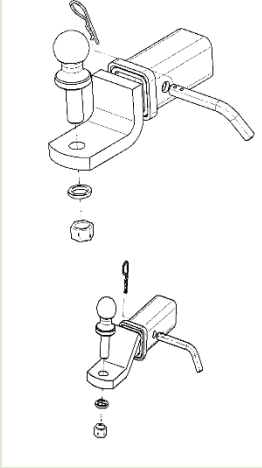
Step	What Important Step	Illustrations / Photo's	How / Why Explanations / Reasoning	Tools & Fasteners	
7	FIT BALL MOUNT		<p>a) You will receive one of these 2 hitches in the kit.</p>		

Step	What Important Step	Illustrations / Photo's	How / Why Explanations / Reasoning	Tools and Fasteners
8	FIT COMPLIANCE STICKER		<p>a) ATTACH TO B PILLAR</p> <p>b) This sticker must be attached at the time of fitting otherwise warranty could be affected</p>	

## TAG TOWBAR WARRANTY STATEMENT

MIKANO Industries, the manufacturer of TAG branded products, warrants your TAG Towbar for its full product life under the following conditions:

- You can show proof of purchase.
- The towbar has been correctly installed by a suitably qualified installer.
- The towbar has not been modified or abused in any way and has only been used for the purpose intended.
- The towbar was not fitted second hand to your vehicle.

The extent of this warranty includes materials and workmanship used in the manufacture of the towbar and is to the equivalent value of current, full replacement cost.

Nothing stated or implied in this warranty limits in any way, the statutory rights that you may have.

To make a claim visit the original installer in the first instance or, if you are unable to or are not satisfied with their help, then contact us direct by phone on 1800 272

or by fax at (07) 3808 1479