

Wiringkit



- D Einbauanleitung
- GB Installation instructions
- F Consignes de montage
- NL Montagehandleiding
- DK Montagevejledning
- N Monteringsinstruksjon
- S Installationsanvisning
- FIN Asennusohje
- I Istruzioni per il montaggio
- E Instrucciones de montaje
- P Instruções de montagem
- GR Οδηγίες εγκατάστασης
- CZ Návod k montáži
- SLO Navodilo za vgradnjo
- SK Montážny návod
- PL Instrukcja montażu
- TR Montaj talimatı
- H Beépítési útmutató
- HR Upute o ugradnji
- BUL инструкции за монтаж
- RO Instrucțiuni de montaj
- RU Инструкция по монтажу и установке
- LT Montavimo informacija
- LV Iemontēšanas pamacība
- EST Paigaldusjuhend

738397 19160508

PEUGEOT

- **308** Hatch 3 & 5 Door 11/08 → 08/13
- **308** SW 11/08 → 04/14

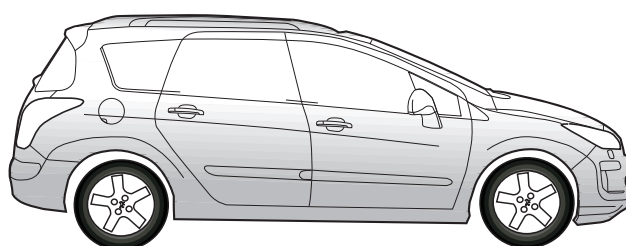
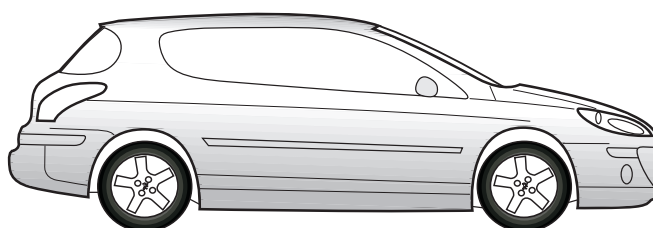

BRiNK®

Your perfect fit
brink.eu

IMPORTANT!



Installation of the towing electrics kit must be undertaken by a specialist workshop or an appropriately qualified person. Before starting work, you must read the installation instructions through completely. After installing the towing electrics kit, the installation instructions should be kept with the vehicle service documentation.

All claims under the guarantee will lapse in case of improper use or modification of the towing electrics kit or any of its component parts. When driving without a trailer or load carrier, any adapter installed must be removed from the electrical socket. We reserve the right to alter the design, content or colour. We accept no liability for any errors in these instructions. All details and illustrations are non-binding.







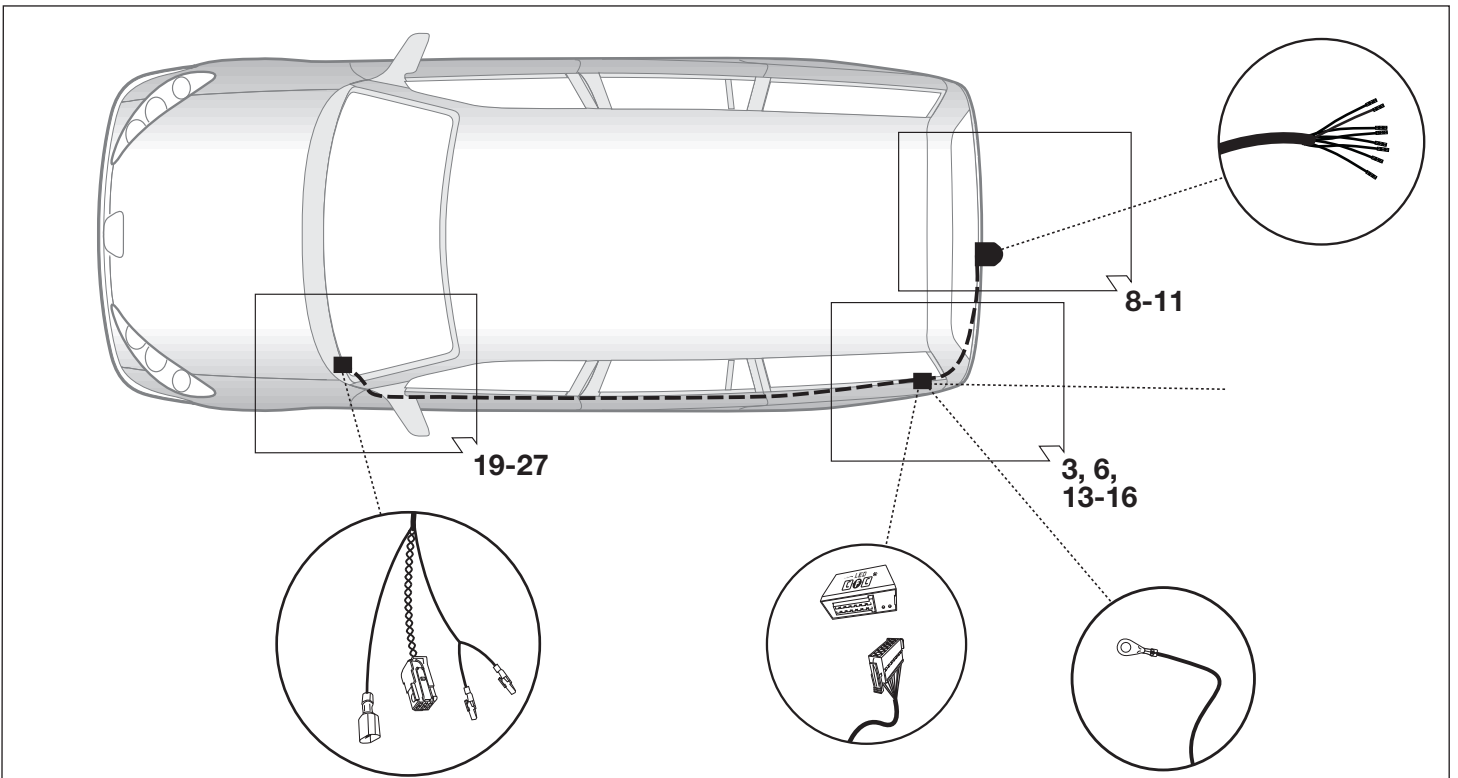
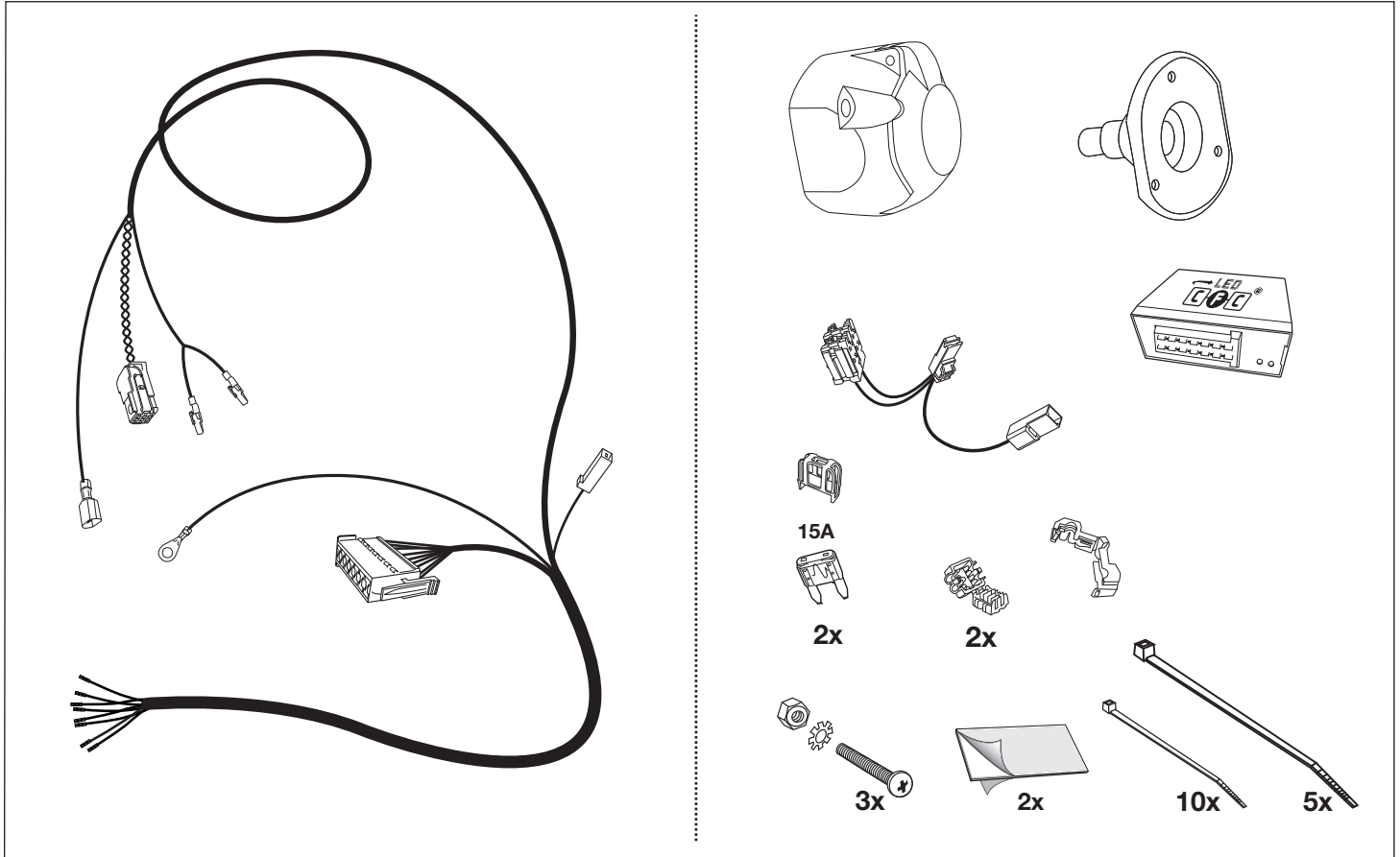













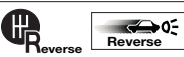





In case of missing a rear fog lamp on the trailer, it should be retrofitted.

We accept no responsibility and give no guarantee for technical and electrical modifications made after the initial operation of the towing electrics kit by the vehicle manufacturer and which may lead, for example to malfunction of the trailer socket or its peripheries.

The trailer module is not diagnostics-capable. If the manufacturer's diagnostics processes or software-supported test mechanisms generate error reports directly or indirectly linked with trailer operation, the trailer module must be disconnected from the leads to the trailer socket and a new diagnostic process initiated.



SYMBOL EXPLANATION

	left (58-L) respectively right (58-R) tail light		cigarette lighter / accessory socket
	stop light (54) / high mounted, third stop light (54)		loudspeaker / buzzer
	turn signal indicator left		Park Distance Control
	turn signal indicator right		switch / source of function
	rear fog light(s)		Connect together
	reversing light(s)		Disconnect
	Permanent power supply / 13pin socket, chamber 9		Look at / See further information
	charging wire for trailer battery / 13pin socket, chamber 10		Look carefully at selected area
	trailer / trailer recognition		Present / Occupied / OK
B+/30	Permanent current power supply		Not present / Not occupied / Not OK
	Ground or Earth (31)		left
	ground connection battery terminal lug		right
	positive connection battery terminal lug		acoustic indication
	fuse / fuse capacity 20 Ampère		attention / important advice

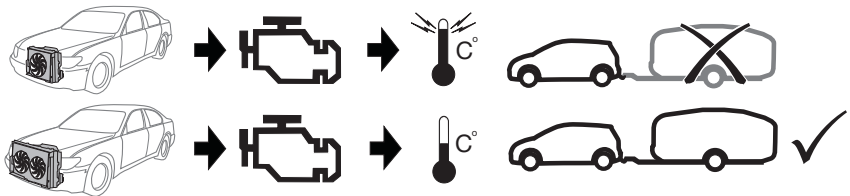

ATTENTION!

The vehicle's cooling capacity may have to be increased when retrofitting a trailer coupling!
You must observe the manufacturer's instructions!!

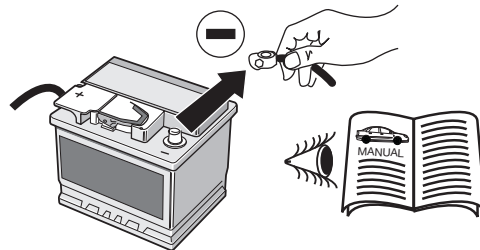

ATTENTION!

In order to avoid mal-functions and damage to the vehicle's electrical system the earth terminal **must be disconnected** from the vehicle's battery **before starting work!**

Both the trailer module and the vehicle's control unit for the electrical system can be damaged during work on the data bus connections if the battery is not disconnected!

Please pay attention to the manufacturer's instructions when disconnecting and reconnecting the vehicle's battery!

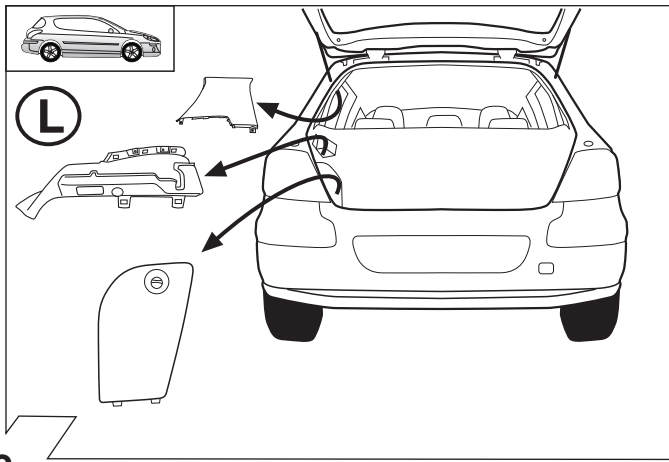

2

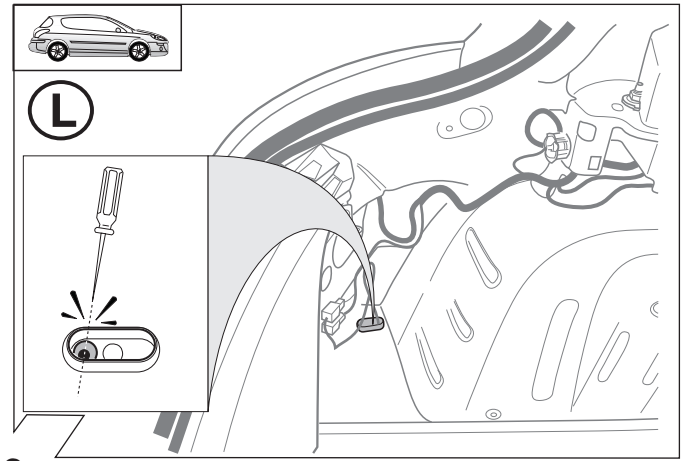

3

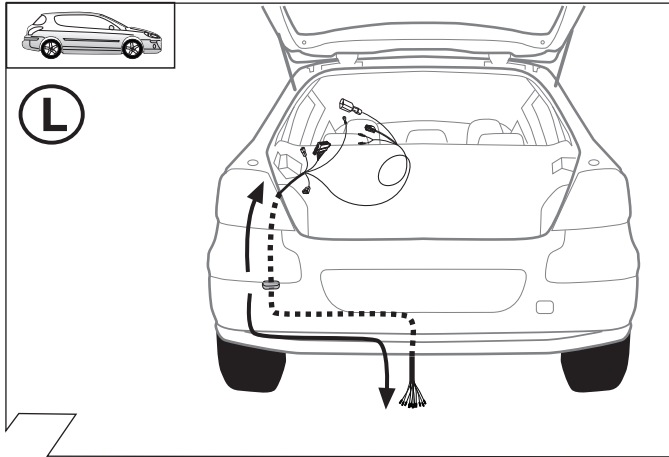

4

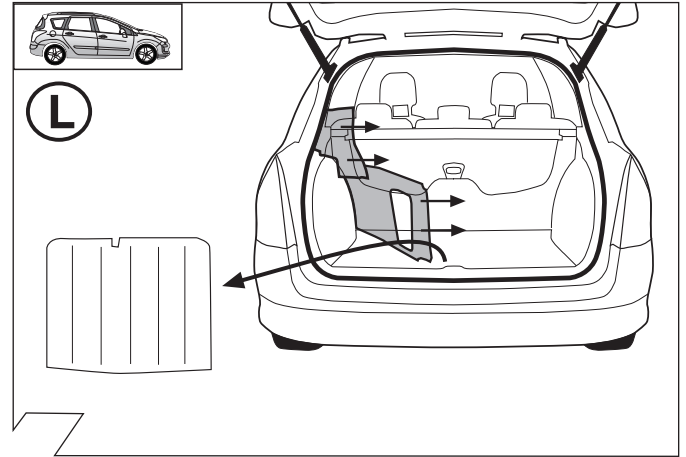

5

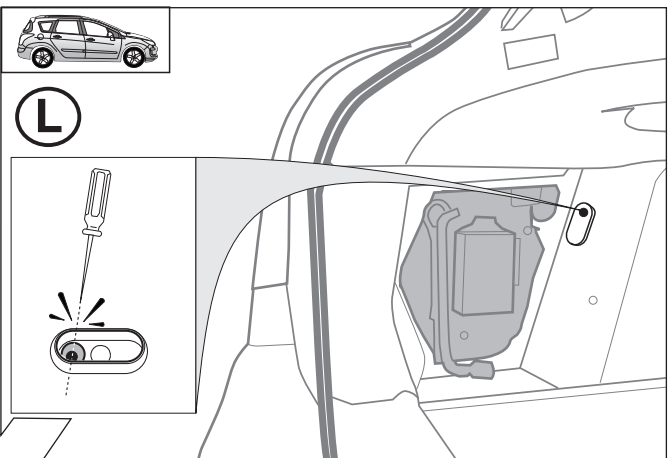

6

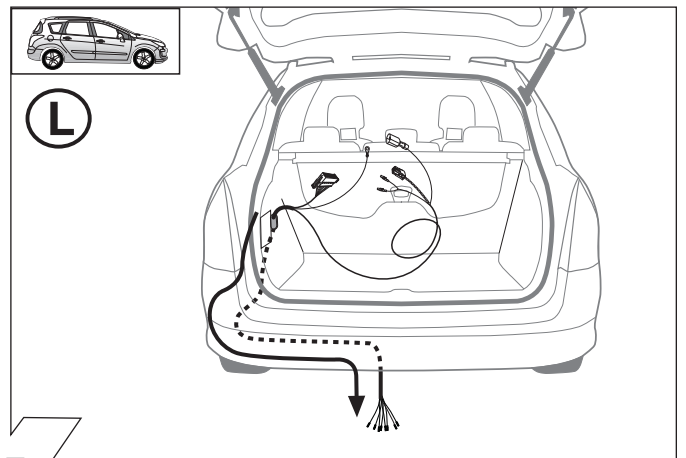

7

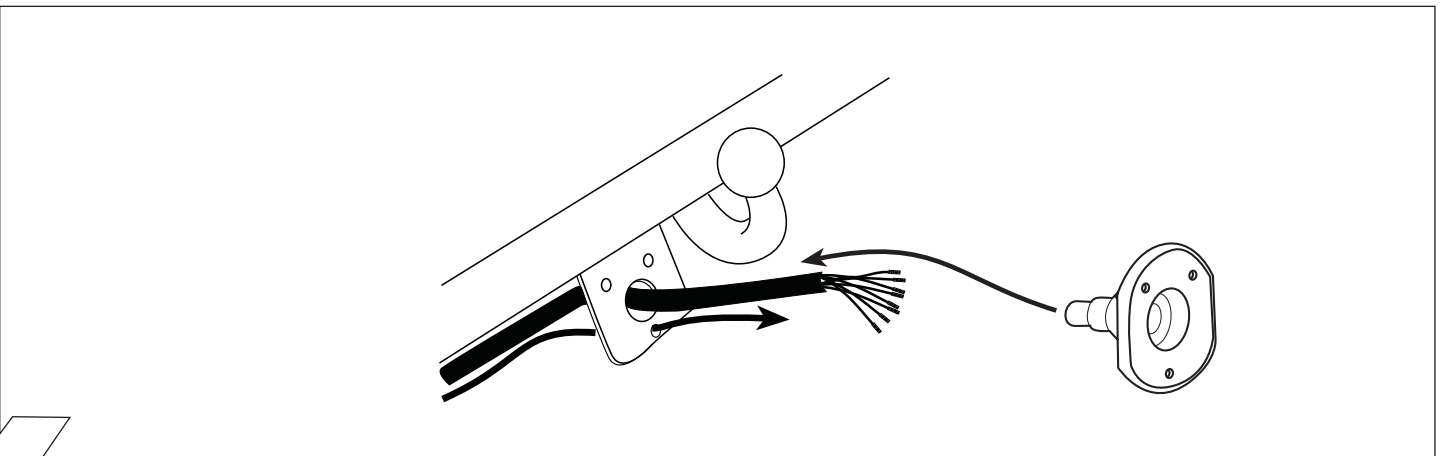

8

ISO 1724	Belegung der Steckdose / Maximale Ausgangsleistung Socket configuration / Maximum power output Correspondance des contacts de la prise / Puissance de sortie maximale Abbinamento della presa / Uscite di alimentazione massima Indeling van de stekkerdoos / maximaal uitgangsvermogen			
	1/L	BK/WT	21W	
	2	WT	42W	
	3/31	BR		
	4/R	BK/GN	21W	
	5/58-R	GY/RD	52W	
	6/54	BK/RD	63W	
	7/58-L	GY/BK	52W	

9

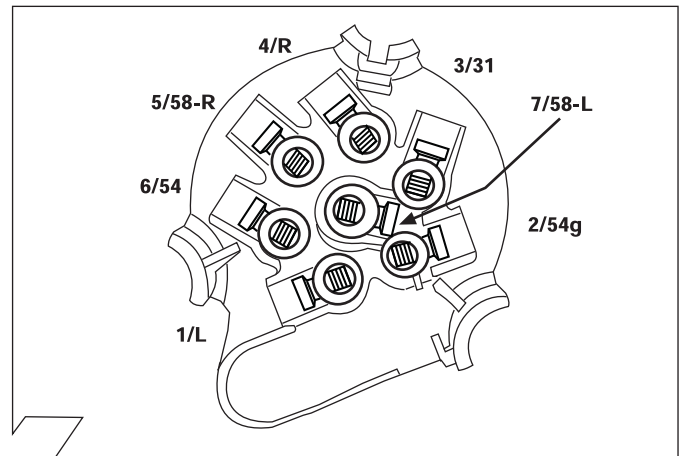

10

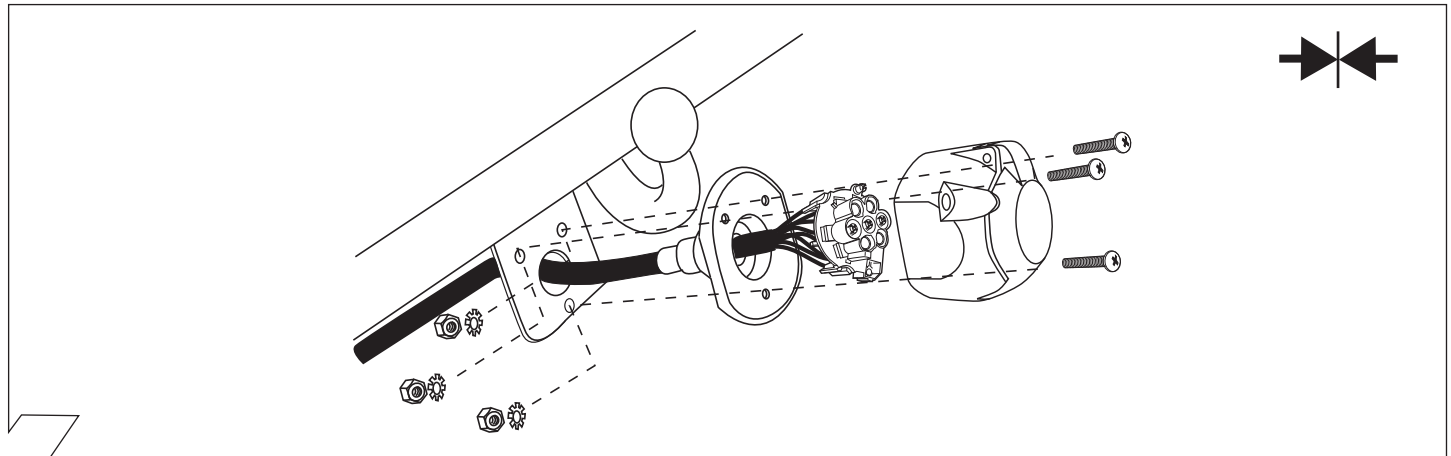

11

	GB	D	E	F	I	P	NL	DK	N	S	FIN	CZ	H	PL	GR	RUS
BK	Black	Schwarz	Negro	Noir	Nero	Preto	Zwart	Sort	Svart	Svart	Musta	Černá	Fekete	Czarny	μαύρος	черный
RD	Red	Rot	Rojo	Rouge	Rosso	Vermelho	Rood	Röd	Röd	Röd	Punainen	Červená	Piros	Czerwony	κόκκινος	красный
GN	Green	Grün	Verde	Vert	Verde	Verde	Groen	Grøn	Grønt	Grön	Vihreä	Zelená	Zöld	Zielony	πράσινος	зеленый
OR	Orange	Orange	Naranja	Orange	Arancione	Laranja	Oranje	Orange	Orange	Orange	Oranssi	Oranzová	Narancs	Pomarańczowy	πορτοκαλί	оранжевый
VT	Violet	Violett	Violeta	Violet	Viola	Violeta	Violet	Violet	Fiolett	Violett	Violetti	Fialová	Ibolya	Fioletowy	βιολέτα	фиолетовый
PK	Pink	Pink	Pink	Rose	Rosa	Cor-de-Rosa	Paars	Pink	Pink	Rosa	Pinkki	Ružová	Rózsaszín	Różowy	Μωβ	розовый
BL	Blue	Blau	Azul	Bleu	Blu	Azul	Blauw	Blå	Blått	Blå	Sininen	Modrá	Kék	Niebieski	μπλε	синий
YL	Yellow	Gelb	Amarillo	Jaune	Giallo	Amarelo	Geel	Gul	Gult	Gul	Keltainen	Zlutá	Sárga	Zóly	κίτρινος	желтый
WT	White	Weiss	Blanco	Blanc	Bianco	Branco	Wit	Hvid	Hvitt	Vit	Valkoinen	Bílá	Fehér	Biały	λευκός	белый
BR	Brown	Braun	Marrón	Brun	Marrone	Marrom	Bruin	Brun	Brunt	Brun	Ruskea	Hnědá	Barna	Brazowy	καφέ	коричневый
GY	Grey	Grau	Gris	Gris	Grigio	Cinzeno	Grijs	Grå	Grått	Grå	Harmaa	Sedá	Szürke	Szary	Γκρι	серый

12

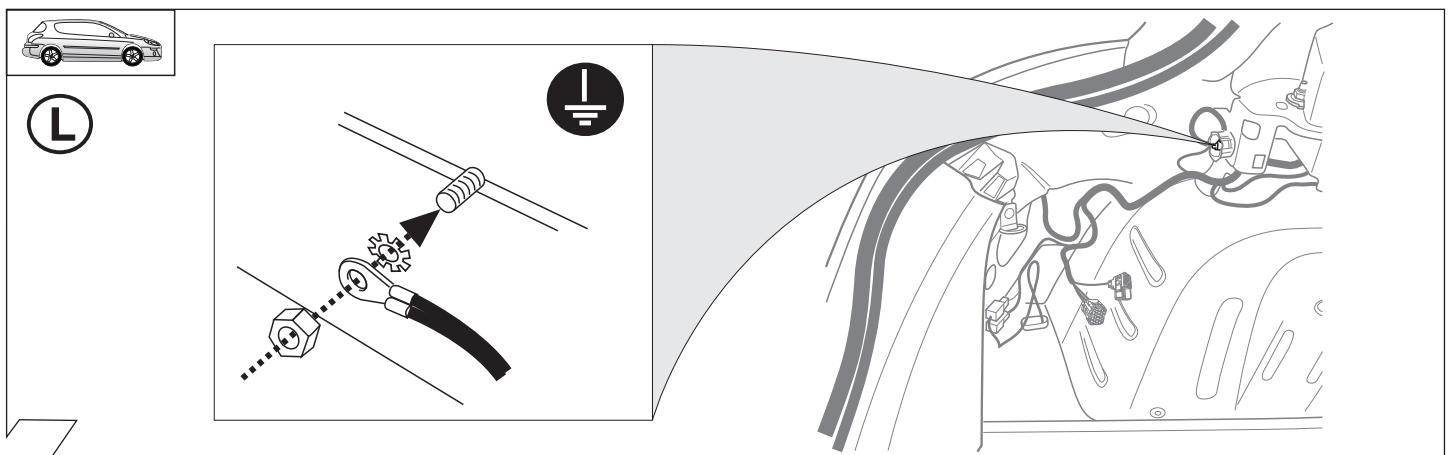

13

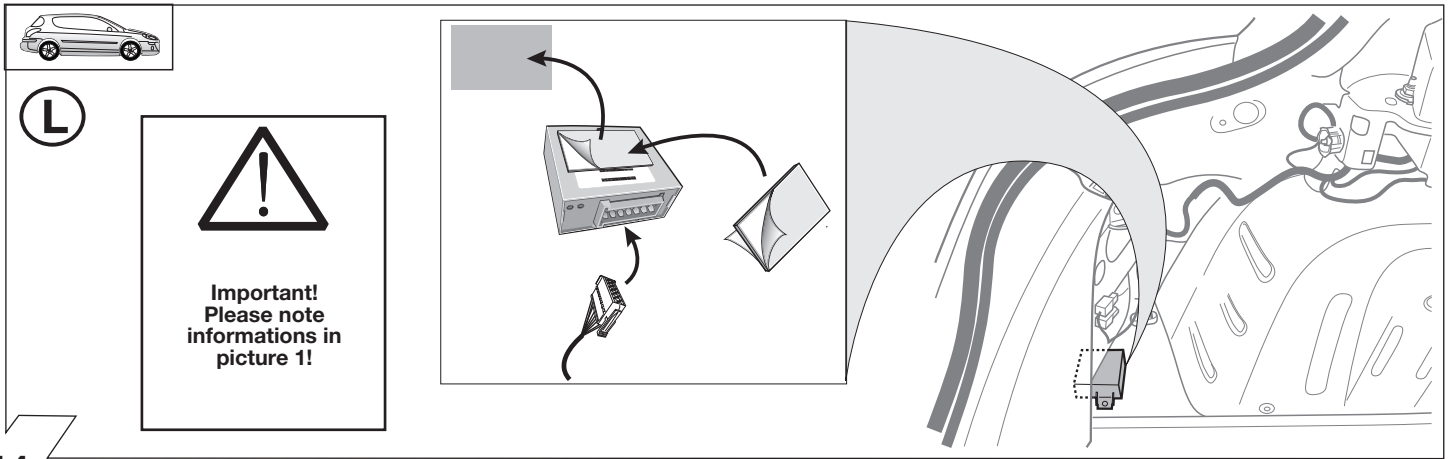

14

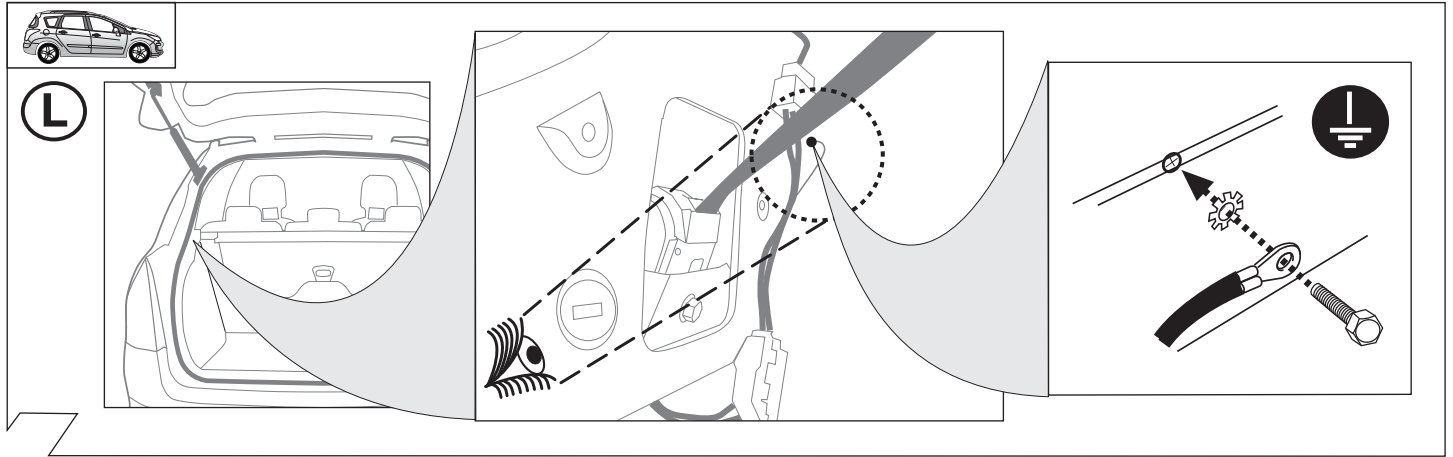

15

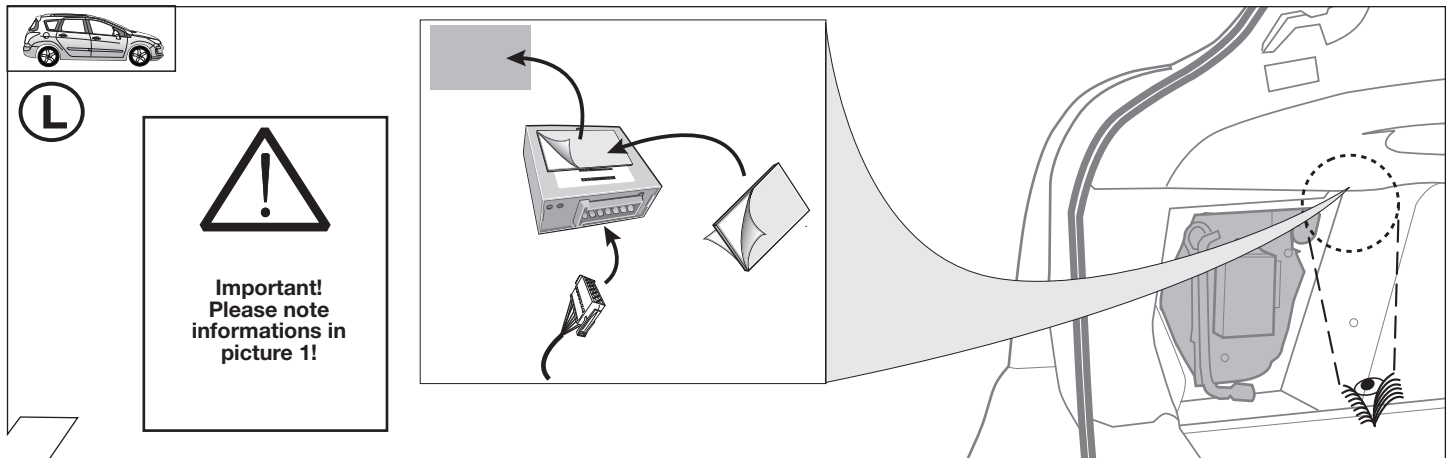

16

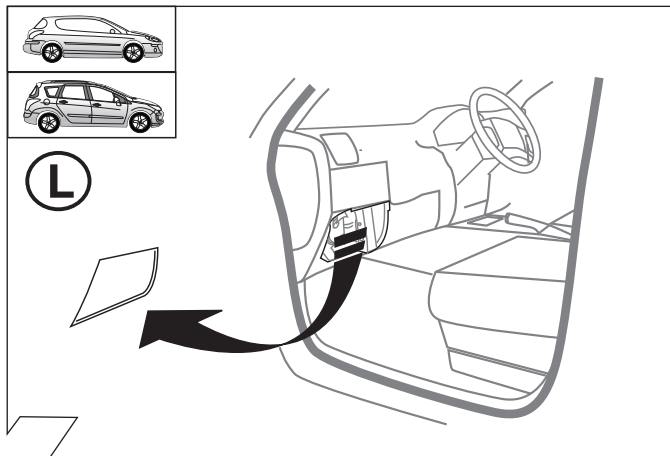

17

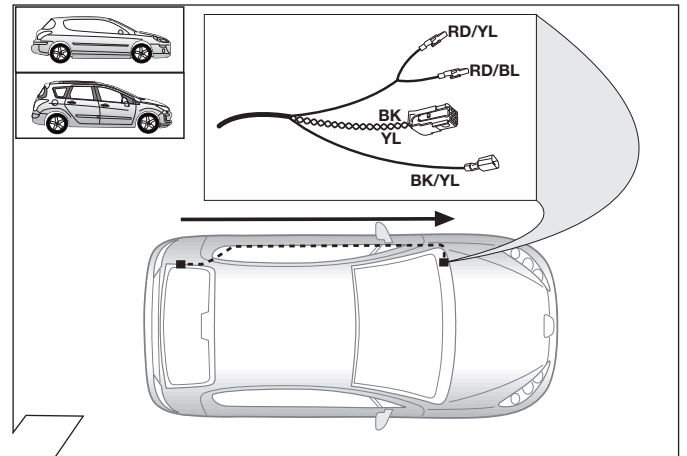

18

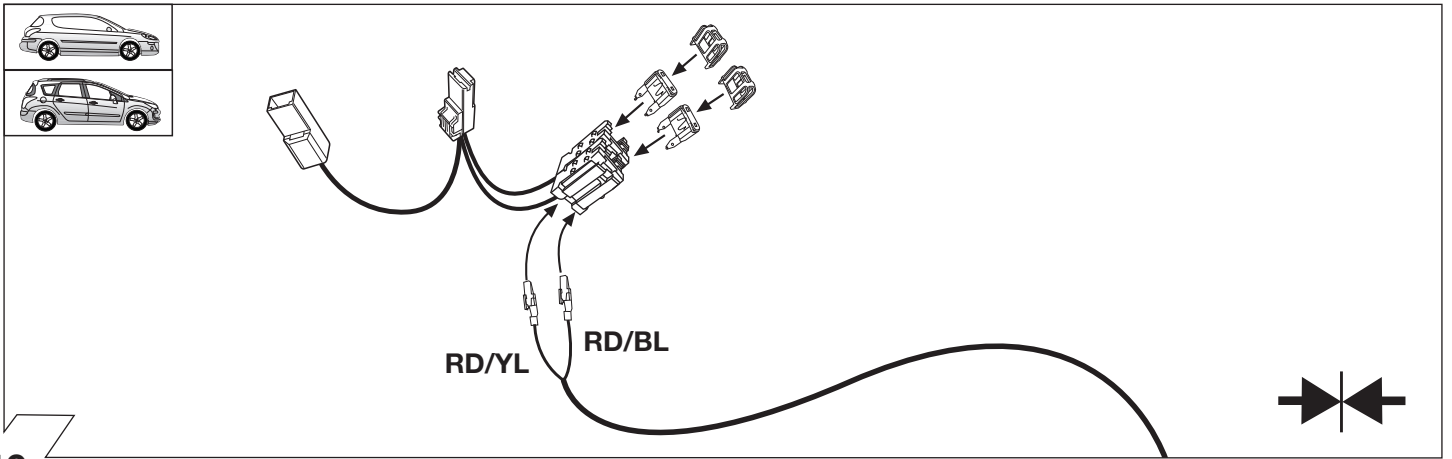

19

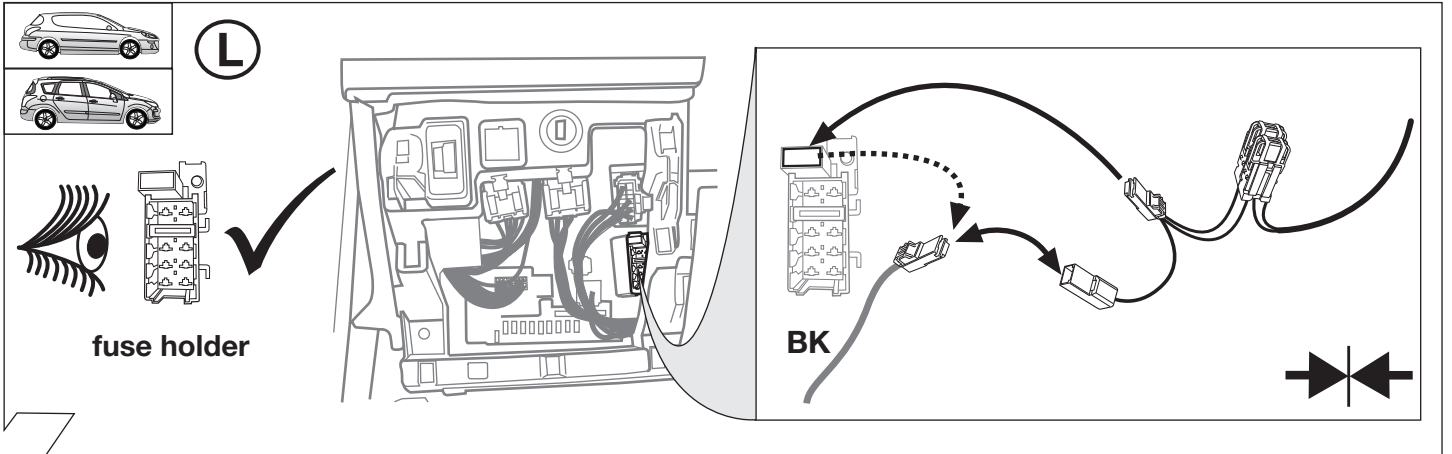

20

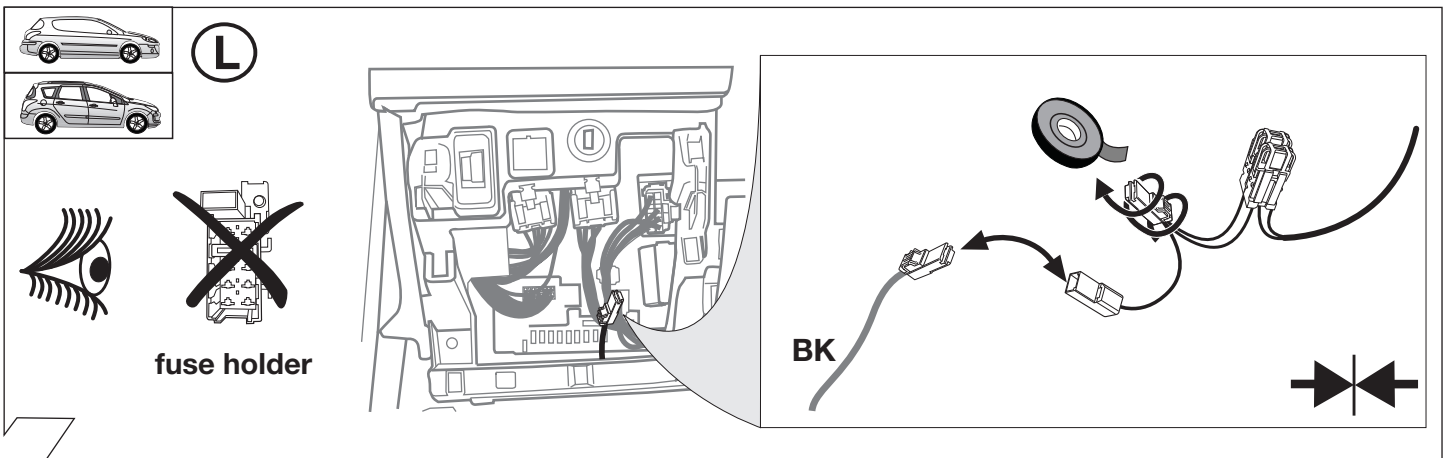

21

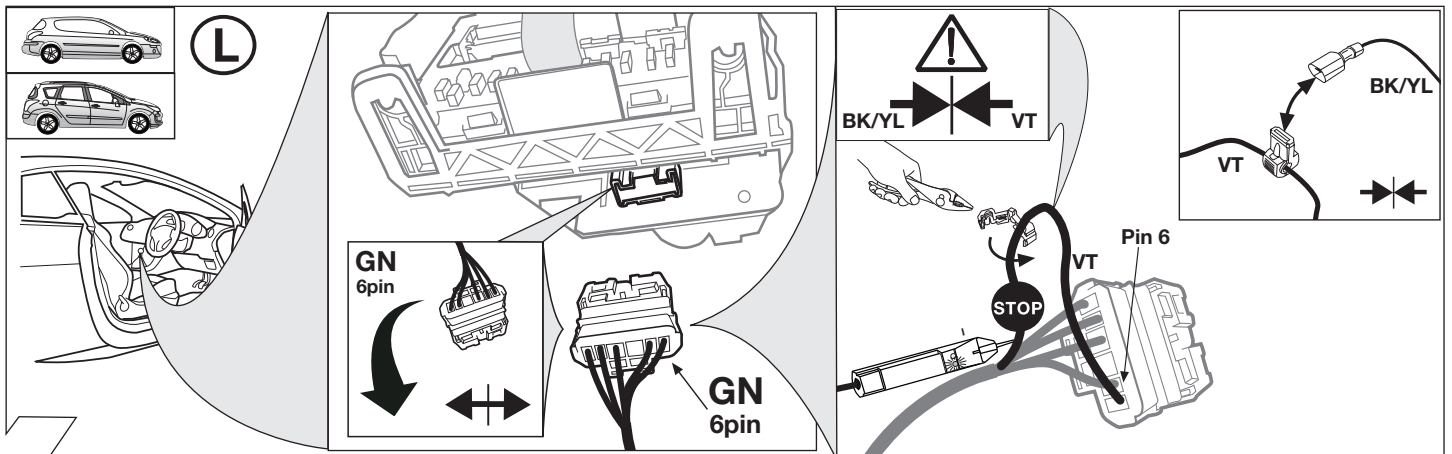

22

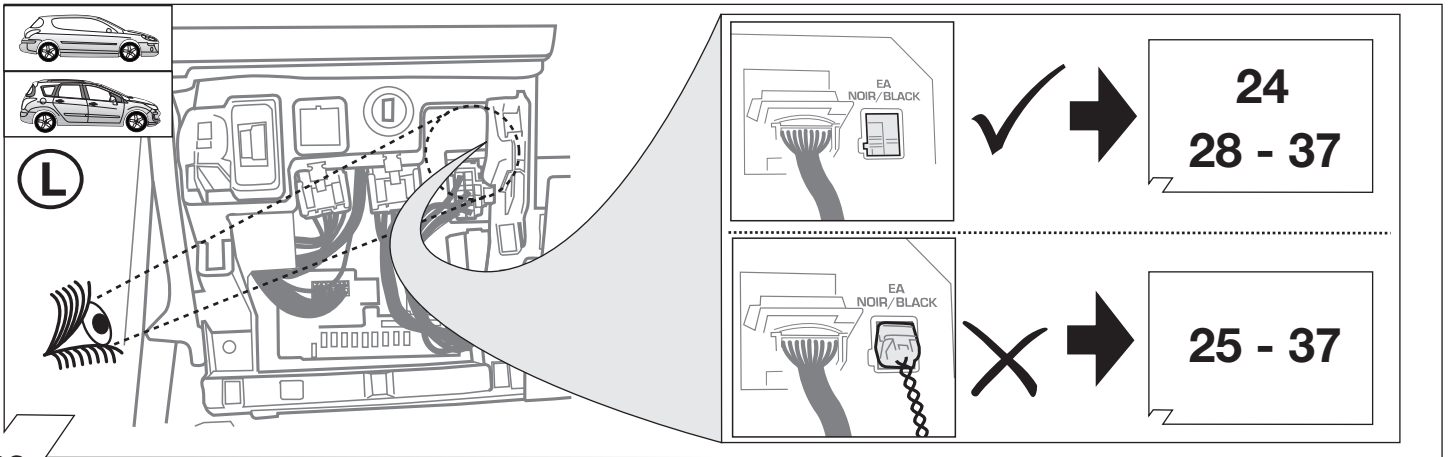

23

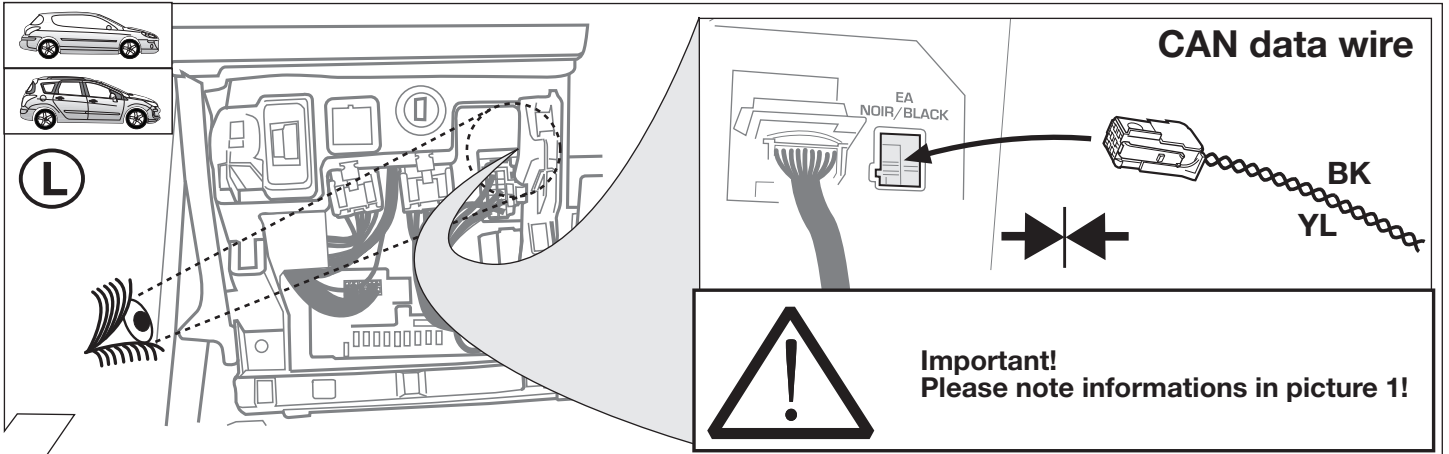

24

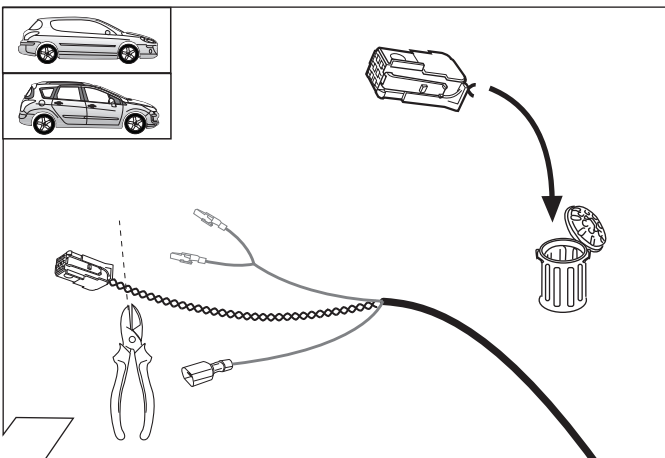

25

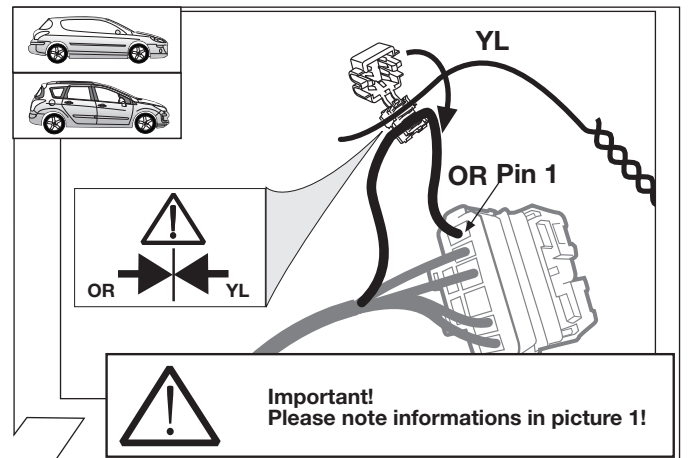

26

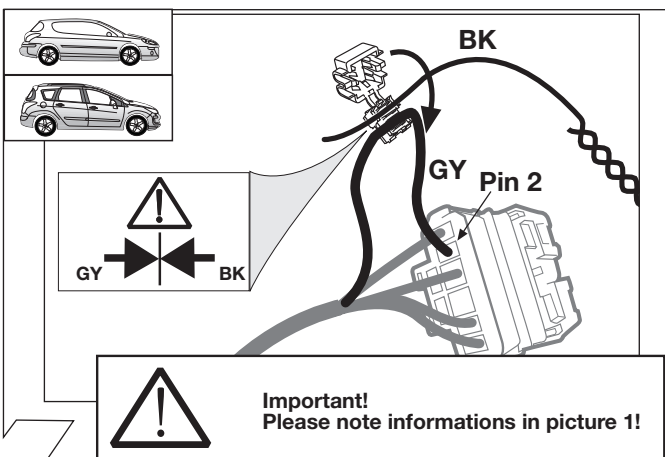

27

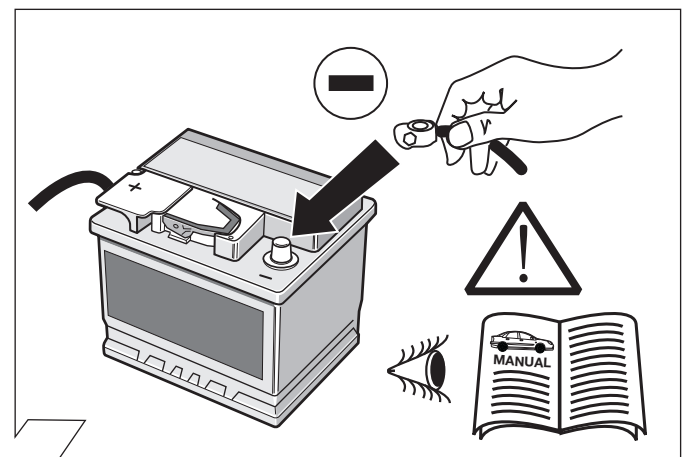

28

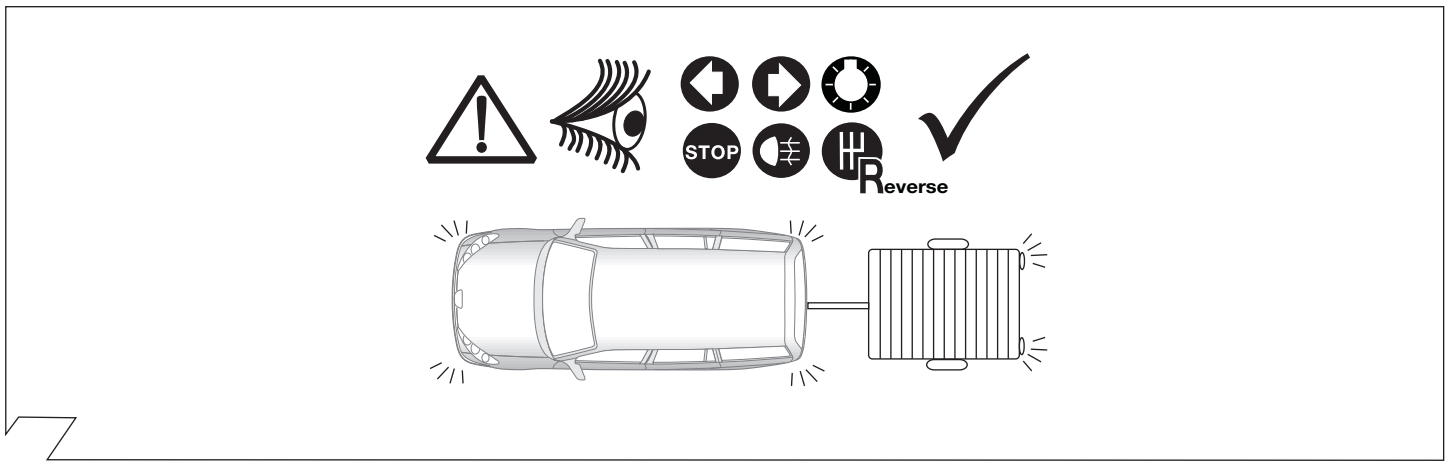

29

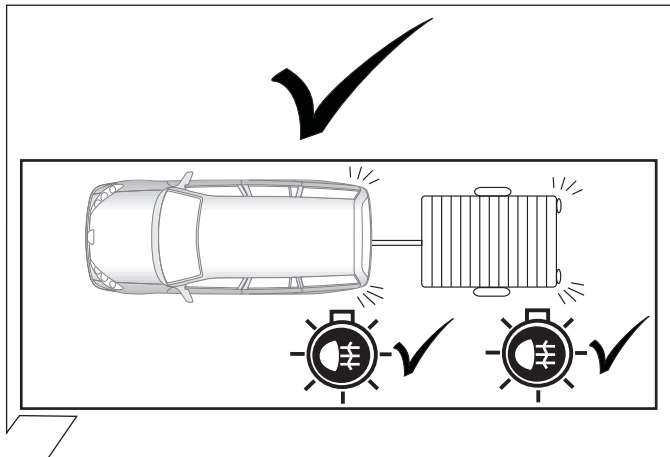

30

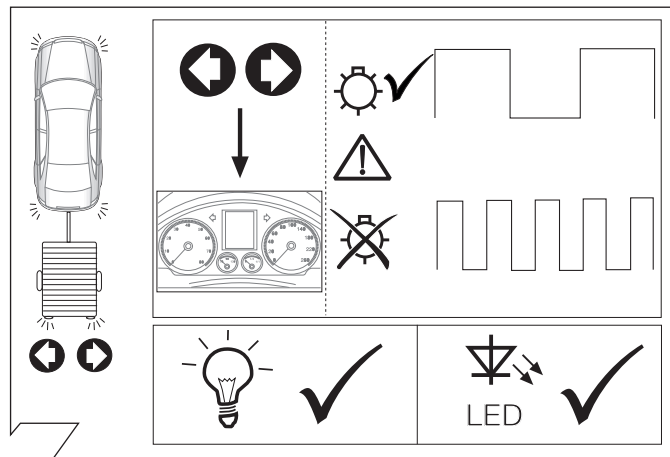

32

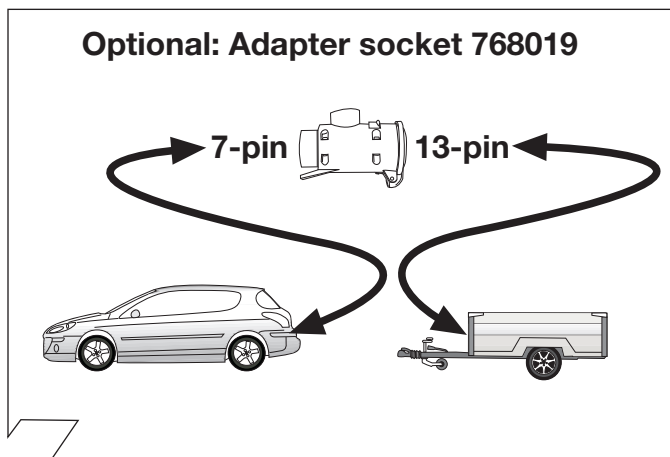

34

Set up trailer operation

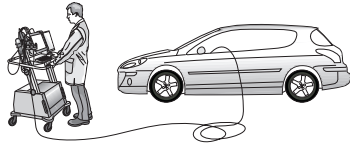
The activation of

- trailer indicator monitoring
- PDC deactivation

must be carried out using the PEUGEOT PPS Tester and PEUGEOT Planet Office Software

- Select the vehicle
- Select the application Peugeot Planet 2000
- Optional extras
- Tow hook
- Installation towbar

31

OPTIONAL

Trailer Simulator for 7- and 13-pin Sockets



Part-no. 765069

33

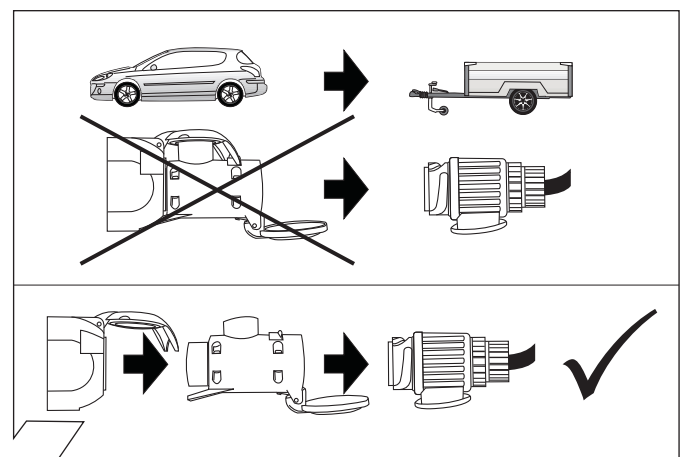

35

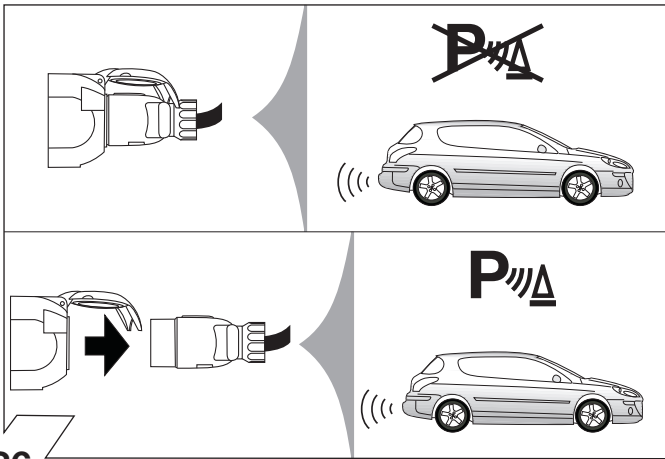

36

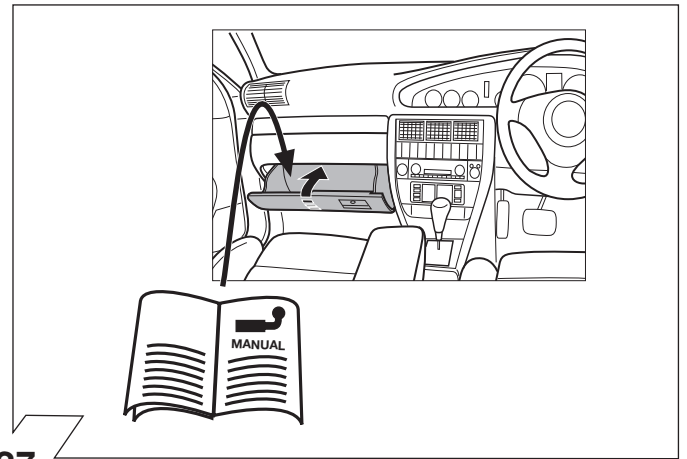

37

Diagnosis function of control LEDs

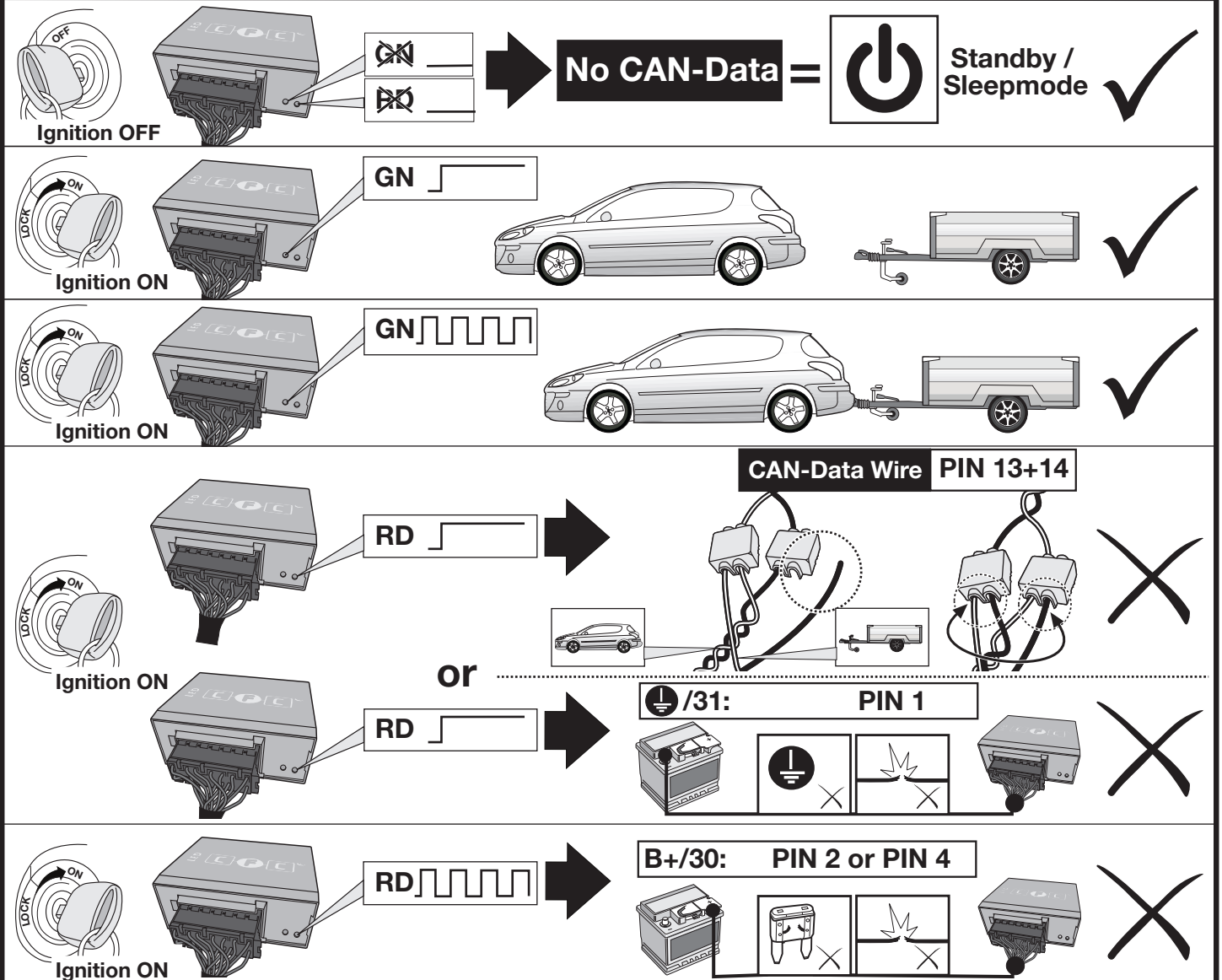

Indicator failure detection and lamp substitution if the trailer indicators fail

The failure of a single or on both trailer indicators will be shown depending on the type of vehicle and electric kit installed as follows:

- Increase in the flashing frequency
- Text message in the Display / combi-instrument
- Activated control lamp for light failure
- Audible warning by Buzzer or Voice-Message

If an indicator fails the left or right light compensates the faulty indicator by flashing at the correct frequency! (→ lamp substitution).