

**PHILIPS**

Interactive Display

3000 Series

43BDL3751T  
55BDL3751T



## User Manual (English)

# Table Of Contents

1. Safety Instructions .....	1	7.4. Apps .....	59
2. Unpacking and Installation.....	10	7.5. Display .....	60
2.1. Unpacking .....	10	7.6. Accessibility.....	60
2.2. Package Contents.....	12	7.7. Security.....	60
2.3. Installation Notes .....	12	7.8. System.....	60
2.4. Mounting on a Wall .....	13	7.9. About.....	61
2.5. Mounting in Portrait Orientation .....	14	8. OSD Menu .....	63
3. Parts and Functions .....	15	8.1. Navigating the OSD Menu .....	63
3.1. Control Panel.....	15	8.2. OSD Menu Overview .....	63
3.2. Input/Output Terminals.....	16	8.3. Android Settings.....	69
3.3. Inserting the Batteries in the Remote Control.....	17	9. Supported Media Formats.....	70
3.4. Handling the Remote Control .....	17	10. Input Mode .....	71
3.5. Operating range of the Remote Control... ..	17	11. Pixel Defect Policy .....	72
3.6. Remote Control.....	18	11.1. Pixels and Sub-Pixels.....	72
3.7. AC Switch Cover.....	22	11.2. Types of Pixel Defects + Dot Definition.....	72
3.8. Open Frame Kit(Optional).....	23	11.3. Bright Dot Defects.....	72
4. Connecting External Equipment .....	24	11.4. Dark Dot Defects .....	73
4.1. Connecting External Equipment (Multimedia Player) .....	24	11.5. Proximity of Pixel Defects .....	73
4.2. Connecting a PC.....	24	11.6. Pixel Defect Tolerances .....	73
4.3. Connecting Audio Equipment.....	25	11.7. MURA.....	73
4.4. Connecting Multiple Displays in a Daisy-Chain Configuration.....	25	12. Cleaning and Troubleshooting .....	74
4.5. IR Connection .....	26	12.1. Cleaning .....	74
4.6. IR Pass-through Connection.....	26	12.2. Troubleshooting .....	75
4.7. Touch Operation.....	27	13. Technical Specifications.....	77
5. Operation .....	29	Warranty Policy for Philips Professional Display Solutions.....	79
5.1. Watch the Connected Video Source.....	29	Index.....	81
5.2. Change Picture Format.....	29		
5.3. Overview .....	29		
5.4. Media Player .....	30		
5.5. Browser.....	33		
5.6. PDF Player .....	37		
5.7. Kiosk.....	39		
5.8. Custom App .....	44		
6. File Manager.....	45		
6.1. File Manager .....	45		
6.2. Display Switch.....	45		
7. Setting UI.....	46		
7.1. Network & Internet .....	46		
7.2. Connected Devices.....	48		
7.3. Signage Display.....	48		

# 1. Safety Instructions

## Safety precautions and maintenance



**WARNING:** Use of controls, adjustments or procedures other than those specified in this documentation may result in exposure to shock, electrical hazards and/or mechanical hazards.

Read and follow these instructions when connecting and using your display:

This product is intended for use in professional installations in business settings only and is not suitable for domestic purposes. Any use other than that for which this device is intended can void the warranty.

This product contains an operating system. If it is shut down directly using the AC switch, it may damage the program and prevent it from powering on again. If the system is unable to power on due to frequent shutdowns, please try a factory reset. Please note that all data stored in the system will be lost when the display is rebooted after a factory reset.

### Operation:

- Keep the display out of direct sunlight and away from stoves or any other heat sources.
- Keep the display away from oil, otherwise the plastic cover may be damaged.
- Remove any object that could fall into ventilation holes or prevent proper cooling of the display's electronics.
- Do not block the ventilation holes on the cabinet.
- When positioning the display, make sure the power plug and outlet are easily accessible.
- When turning off the display by detaching the power cord, wait 6 seconds before re-attaching the power cord for normal operation.
- Ensure the use of an approved power cord provided by Philips at all times. If your power cord is missing, please contact your local service center.
- Do not subject the display to severe vibration or high impact conditions during operation.
- Do not knock or drop the display during operation or transportation.
- The eye bolt is for usage in short-time maintenance and installation. We suggest not to use the eye bolt for more than 1 hour. Prolong usage is prohibited. Please keep a clear safety area under the display while using the eye bolt.

### Maintenance:

- To protect your display from possible damage, do not put excessive pressure on the LCD panel. When moving your display, grasp the frame to lift; do not lift the display by placing your hands or fingers on the LCD panel.
- Unplug the display if you are not going to use it for an extensive period of time.
- Unplug the display if you need to clean it with a slightly damp cloth. The screen may be wiped with a dry cloth when the power is off. However, never use organic solvent, such as, alcohol, or ammonia-based liquids to clean your display.
- To avoid the risk of shock or permanent damage to the set, do not expose the display to dust, rain, water or an excessively moist environment.
- If your display becomes wet, wipe it with dry cloth as soon as possible.
- If a foreign substance or water gets in your display, turn the power off immediately and disconnect the power cord. Then remove the foreign substance or water, and send the unit to the maintenance center.
- Do not store or use the display in locations exposed to heat, direct sunlight or extreme cold.
- In order to maintain the best performance of your display and ensure a longer lifetime, we strongly recommend using the display in a location that falls within the following temperature and humidity ranges.
  - Temperature: 0-40°C 32-104°F
  - Humidity: 20-80% RH
- LCD panel temperature need to be 25 degrees Celsius at all time for better luminance performance.

**IMPORTANT:** Always activate a moving screen saver program when you leave your display unattended. Always activate a periodic screen refresh application if the unit will display unchanging static content. Uninterrupted display of still or static images over an extended period may cause "burn in", also known as "after-imaging" or "ghost imaging", on your screen. This is a well-known phenomenon in LCD panel technology. In most cases, the "burned in" or "after-imaging" or "ghost imaging" will disappear gradually over a period of time after the power has been switched off.

**WARNING:** Severe "burn-in" or "after-image" or "ghost image" symptoms will not disappear and cannot be repaired. This is also not covered under the terms of your warranty.

**Service:**

- The casing cover should be opened only by qualified service personnel.
- If there is any need for repair or integration, please contact your local service center.
- Do not leave your display under direct sunlight.



If your display does not operate normally, having followed the instructions set out in this document, please contact a technician or your local service center.

**Stability Hazard**

The device may fall, causing serious personal injury or death. To prevent injury, this device must be securely attached to the floor/wall in accordance with the installation instructions.

**Read and follow these instructions when connecting and using your display:**

- Unplug the display if you are not going to use it for an extensive period of time.
- Unplug the display if you need to clean it with a slightly damp cloth. The screen may be wiped with a dry cloth when the power is off. However, never use alcohol, solvents or ammonia-based liquids.
- Consult a service technician if the display does not operate normally when you have followed the instructions in this manual.
- The casing cover should be opened only by qualified service personnel.
- Keep the display out of direct sunlight and away from stoves or any other heat sources.
- Remove any object that could fall into the vents or prevent proper cooling of the display's electronics.
- Do not block the ventilation holes on the cabinet.
- Keep the display dry. To avoid electric shock, do not expose it to rain or excessive moisture.
- When turning off the display by detaching the power cable or DC power cord, wait for 6 seconds before re-attaching the power cable or DC power cord for normal operation..
- To avoid the risk of shock or permanent damage to the set do not expose the display to rain or excessive moisture.
- When positioning the display, make sure the power plug and outlet are easily accessible.
- **IMPORTANT:** Always activate a screen saver program during your application. If a still image in high contrast remains on the screen for an extended period of time, it may leave an 'after-image' or 'ghost image' on the front of the screen. This is a well-known phenomenon that is caused by the shortcomings inherent in LCD technology. In most cases the afterimage will disappear gradually over a period of time after the power has been switched off. Be aware that the after-image symptom cannot be repaired and is not covered under warranty.
- If provided with a 3-pin attachment plug on the power cord, plug the cord into a grounded (earthed) 3-pin outlet. Do not disable the power cord grounding pin, for example, by attaching a 2-pin adapter. The grounding pin is an important safety feature.

**EU Declaration of Conformity/UK Declaration of Conformity**

This device complies with the requirements set out in the Council Directive on the Approximation of the Laws of the Member States relating to Electromagnetic Compatibility (2014/30/EU), Low-voltage Directive (2014/35/EU), RoHS Directive (2011/65/ EU), ESPR Regulation (EU) 2024/1781(Regulation (EU) 2019/2021).The Radio Equipment Directive(2014/53/EU) or Radio Equipment Regulations 2017(for UK).

This product has been tested and found to comply with the harmonized standards for Information Technology Equipment, these harmonized standards published under Directives of Official Journal of the European Union.

**ESD Warnings**

When user close to the monitor may cause the equipment discharge and reboot to the display of main menu.

**Warning:**

This equipment is compliant with Class A of EN55032/CISPR 32. In a residential environment this equipment may cause radio interference.



## Federal Communications Commission (FCC) Notice (U.S. Only)



**NOTE:** This equipment has been tested and found to comply with the limits for a Class A digital device, pursuant to part 15 of the FCC Rules. These limits are designed to provide reasonable protection against harmful interference when the equipment is operated in a commercial environment. This equipment generates, uses, and can radiate radio frequency energy and, if not installed and used in accordance with the instruction manual, may cause harmful interference to radio communications. Operation of this equipment in a residential area is likely to cause harmful interference in which case the user will be required to correct the interference at his own expense.



Changes or modifications not expressly approved by the party responsible for compliance could void the user's authority to operate the equipment.

Use only an RF shielded cable that was supplied with the display when connecting this display to a computer device.

To prevent damage which may result in fire or shock hazard, do not expose this appliance to rain or excessive moisture.

This device complies with Part 15 of the FCC / ISED's licence-exempt RSSs Rules. Operation is subject to the following two conditions: (1) This device may not cause harmful interference, and (2) this device must accept any interference received, including interference that may cause undesired operation.

Le présent appareil est conforme aux CNR d'ISED applicables aux appareils radio exempts de licence. L'exploitation est autorisée aux deux conditions suivantes : (1) le dispositif ne doit pas produire de brouillage préjudiciable, et (2) ce dispositif doit accepter tout brouillage reçu, y compris un brouillage susceptible de provoquer un fonctionnement indésirable.

TPV USA Corp  
6525 Carnegie Blvd #200  
Charlotte, NC 28211  
USA

## Europe Statement

### IMPORTANT NOTE:

The device is restricted to indoor use only when operating in the 5150 to 5350MHz frequency range. ( for 5G product only)

	AT	BE	BG	HR	CY	CZ	DK
	EE	FI	FR	DE	EL	HU	IE
	IT	LV	LT	LU	MT	NL	PL
	PT	RO	SK	SI	ES	SE	UK(NI)
	UK						

### Radiation Exposure Statement:

This equipment complies with CE radiation exposure limits set forth for an uncontrolled environment. This equipment should be installed and operated with minimum distance 20cm between the radiator & body.

The frequency, mode and the maximum transmitted power in EU are listed below:

2400-2483.5MHz: < 20 dBm (EIRP) ( for 2.4G product only)

5150-5250MHz: < 23 dBm (EIRP)

5250-5350MHz: < 23 dBm (EIRP)

5470-5725MHz: < 30 dBm (EIRP)

5725-5825MHz: < 13.98 dBm (EIRP)

### **FCC/ISED/CE-RED Caution:**

Any changes or modifications not expressly approved by the party responsible for compliance could void the user's authority to operate this equipment.

This transmitter must not be co-located or operating in conjunction with any other antenna or transmitter.

Operations in the 5GHz products are restricted to indoor usage only.

### **Déclaration d'exposition aux radiations:**

Cet équipement est conforme aux limites d'exposition aux rayonnements ISED établies pour un environnement non contrôlé. Cet équipement doit être installé et utilisé avec un minimum de 20cm de distance entre la source de rayonnement et votre corps.

### **Canada:**

Industry Canada statement:

This device complies with RSS-247 of the Industry Canada Rules. Operation is subject to the following two conditions: (1) This device may not cause harmful interference, and (2) this device must accept any interference received, including interference that may cause undesired operation.

Ce dispositif est conforme à la norme CNR-247 d'Industrie Canada applicable aux appareils radio exempts de licence. Son fonctionnement est sujet aux deux conditions suivantes: (1) le dispositif ne doit pas produire de brouillage préjudiciable, et (2) ce dispositif doit accepter tout brouillage reçu, y compris un brouillage susceptible de provoquer un fonctionnement indésirable.

### **Radiation Exposure Statement:**

This equipment complies with FCC/ISED/CE-RED radiation exposure limits set forth for an uncontrolled environment. This equipment should be installed and operated with minimum distance 20cm between the radiator & your body.

### **Déclaration d'exposition aux radiations:**

Cet équipement est conforme aux limites d'exposition aux rayonnements ISED établies pour un environnement non contrôlé. Cet équipement doit être installé et utilisé avec un minimum de 20 cm de distance entre la source de rayonnement et votre corps.

## Polish Center for Testing and Certification Notice

The equipment should draw power from a socket with an attached protection circuit (a three-prong socket). All equipment that works together (computer, display, printer, and so on) should have the same power supply source.

The phasing conductor of the room's electrical installation should have a reserve short-circuit protection device in the form of a fuse with a nominal value no larger than 16 amperes (A).

To completely switch off the equipment, the power supply cable must be removed from the power supply socket, which should be located near the equipment and easily accessible.

A protection mark "B" confirms that the equipment is in compliance with the protection usage requirements of standards PN-93/T-42107 and PN-89/E-06251.

### ***Wymagania Polskiego Centrum Badań i Certyfikacji***

Urządzenie powinno być zasilane z gniazda z przyłączonym obwodem ochronnym (gniazdo z kolkiem). Współpracujące ze sobą urządzenia (komputer, monitor, drukarka) powinny być zasilane z tego samego źródła.

Instalacja elektryczna pomieszczenia powinna zawierać w przewodzie fazowym rezerwową ochronę przed zwarciami, w postaci bezpiecznika o wartości znamionowej nie większej niż 16A (amperów).

W celu całkowitego wyłączenia urządzenia z sieci zasilania, należy wyjąć wtyczkę kabla zasilającego z gniazdka, które powinno znajdować się w pobliżu urządzenia i być łatwo dostępne.

Znak bezpieczeństwa "B" potwierdza zgodność urządzenia z wymaganiami bezpieczeństwa użytkowania zawartymi w PN-93/T-42107 i PN-89/E-06251.

### ***Pozostałe instrukcje bezpieczeństwa***

- Nie należy używać wtyczek adapterowych lub usuwać kolka obwodu ochronnego z wtyczki. Jeżeli konieczne jest użycie przedłużacza to należy użyć przedłużacza 3-żyłowego z prawidłowo połączonym przewodem ochronnym.
- System komputerowy należy zabezpieczyć przed nagłymi, chwilowymi wzrostami lub spadkami napięcia, używając eliminatora przepięć, urządzenia dopasowującego lub bezzakłóceniewego źródła zasilania.
- Należy upewnić się, aby nic nie leżało na kablach systemu komputerowego, oraz aby kable nie były umieszczone w miejscu, gdzie można byłoby na nie nadeptywać lub potykać się o nie.
- Nie należy rozlewać napojów ani innych płynów na system komputerowy.
- Nie należy wpychać żadnych przedmiotów do otworów systemu komputerowego, gdyż może to spowodować pożar lub porażenie prądem, poprzez zwarcie elementów wewnętrznych.
- System komputerowy powinien znajdować się z dala od grzejników i źródeł ciepła. Ponadto, nie należy blokować otworów wentylacyjnych. Należy unikać kładzenia luźnych papierów pod komputer oraz umieszczania komputera w ciasnym miejscu bez możliwości cyrkulacji powietrza wokół niego.

## Electric, Magnetic and Electromagnetic Fields ("EMF")

1. We manufacture and sell many products targeted at consumers, which, like any electronic apparatus, in general have the ability to emit and receive electromagnetic signals.
2. One of our leading Business Principles is to take all necessary health and safety measures for our products, to comply with all applicable legal requirements and to stay well within the EMF standards applicable at the time of producing the products.
3. We are committed to develop, produce and market products that cause no adverse health effects.
4. We confirm that if its products are handled properly for their intended use, they are safe to use according to scientific evidence available today.
5. We play an active role in the development of international EMF and safety standards, enabling us to anticipate further developments in standardization for early integration in its products.

## Information for U.K. only

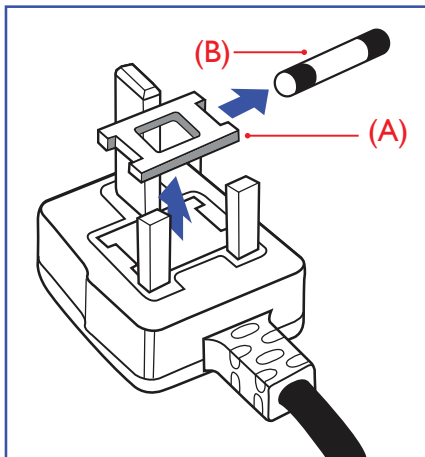

### WARNING - THIS APPLIANCE MUST BE EARTHED.

#### Important:

This apparatus is supplied with an approved moulded 13A plug. To change a fuse in this type of plug proceed as follows:+

1. Remove fuse cover and fuse.
2. Fit new fuse which should be a BS 1362 5A, A.S.T.A. or BSI approved type.
3. Refit the fuse cover.

If the fitted plug is not suitable for your socket outlets, it should be cut off and an appropriate 3-pin plug fitted in its place.

If the mains plug contains a fuse, this should have a value of 5A. If a plug without a fuse is used, the fuse at the distribution board should not be greater than 5A.

Note: The severed plug must be destroyed to avoid a possible shock hazard should it be inserted into a 13A socket elsewhere.

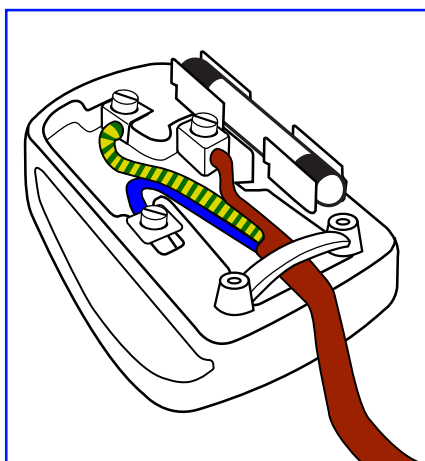

#### How to connect a plug

The wires in the mains lead are coloured in accordance with the following code:

BLUE - "NEUTRAL" ("N")

BROWN - "LIVE" ("L")

GREEN & YELLOW - "EARTH" ("E")

1. The GREEN & YELLOW wire must be connected to the terminal in the plug which is marked with the letter "E" or by the Earth symbol or coloured GREEN or GREEN & YELLOW.
2. The BLUE wire must be connected to the terminal which is marked with the letter "N" or coloured BLACK.
3. The BROWN wire must be connected to the terminal which marked with the letter "L" or coloured RED.

Before replacing the plug cover, make certain that the cord grip is clamped over the sheath of the lead - not simply over the three wires.

## North Europe (Nordic Countries) Information

Placering/Ventilation

#### VARNING:

FÖRSÄKRA DIG OM ATT HUVUDBRYTARE OCH UTTAG ÄR LÄTÅTKOMLIGA, NÄR DU STÄLLER DIN UTRUSTNING PÅPLATS.

Placering/Ventilation

#### ADVARSEL:

SØRG VED PLACERINGSFOR, AT NETLEDNINGENS STIK OG STIKKONTAKT ER NEMT TILGÆNGELIGE.

Paikka/Ilmankierto

#### VAROITUS:

SIIJOITA LAITE SITEN, ETTÄ VERKKOJOHTO VOIDAAN TARVITTAESSA HELPOSTI IRROTTAA PISTORASIESTA.

Plassering/Ventilasjon

#### ADVARSEL:

NÅR DETTE UTSTYRET Plasseres, MÅ DU PASSE PÅ AT KONTAKTENE FOR STØMTILFØRSEL ER LETTE Å NÅ.

## China RoHS

根据中国大陆《电器电子产品有害物质限制使用管理办法》，以下部分列出了本产品中可能包含的有害物质的名称和含量。

部件名称	有害物质					
	铅 (Pb)	汞 (Hg)	镉 (Cd)	六价铬 (Cr (VI))	多溴联苯 (PBB)	多溴二苯醚 (PBDE)
外壳	O	O	O	O	O	O
液晶显示屏	X	O	O	O	O	O
电路板组件*	X	O	O	O	O	O
电源适配器	X	O	O	O	O	O
电源线/连接线	X	O	O	O	O	O
遥控器	X	O	O	O	O	O

本表格依据SJ/T 11364 的规定编制。

\*: 电路板组件包括印刷电路板及其构成的零部件，如电阻、电容、集成电路、连接器等。

O: 表示该有害物质在该部件所有均质材料中的含量均在 GB/T 26572规定的限量要求以下。

X: 表示该有害物质至少在该部件的某一均质材料中的含量超出GB/T 26572规定的限量要求。

上表中打“X”的部件，应功能需要，部分有害物质含量超出GB/T 26572规定的限量要求，但符合欧盟 RoHS法规要求（属于豁免部分）。



### 环保使用期限

此标识指期限（十年），电子电气产品中含有的有害物质在正常使用的条件下不会发生外泄或突变，电子电气产品用户使用该电子电气产品不会对环境造成严重污染或对其人身、财产造成严重损害的期限。

### 《废弃电器电子产品回收处理管理条例》提示性说明

为了更好地关爱及保护地球，当用户不再需要此产品或产品寿命终止时，请遵守国家废弃电器电子产品回收处理相关法律法规，将其交给当地具有国家认可的回收处理资质的厂商进行回收处理，不当利用或者处置可能会对环境和人类健康造成影响。

**警告：**在居住环境中，运行此设备可能会造成无线电干扰。

**警語：**使用過度恐傷害視力。

**注意事項：**

(1) 使用 30 分鐘請休息 10 分鐘。

(2) 未滿 2 歲幼兒不看螢幕，2 歲以上每天看螢幕不要超過 1 小時。

**警告使用者：**

此為甲類資訊技術設備，於居住環境中使用時，可能會造成射頻擾動，在此種情況下，使用者會被要求採取某些適當的對策。

**警告：**為避免電磁干擾，本產品不應安裝或使用於住宅環境。

### Turkey RoHS:

Türkiye Cumhuriyeti: EEE Yönetmeliğine Uygundur

### Ukraine RoHS:

Обладнання відповідає вимогам Технічного регламенту щодо обмеження використання деяких небезпечних речовин в електричному та електронному обладнанні, затвердженого постановою Кабінету Міністрів України від 3 грудня 2008 № 1057

### Vietnam RoHS:

This product is compliant with requirements of Circular No. 30/2011/TT-BCT Regulations "STIPULATING TEMPORARILY THE PERMISSIBLE CONTENT LIMITATION OF SOME TOXIC CHEMICALS IN THE ELECTRONIC, ELECTRICAL PRODUCTS".

## End-of-Life Disposal

Your new Public Information Display contains materials that can be recycled and reused. Specialized companies can recycle your product to increase the amount of reusable materials and to minimize the amount to be disposed of.

Please find out about the local regulations on how to dispose of your old display from your local Philips dealer.

**(For customers in Canada and U.S.A.)**

This product may contain lead and/or mercury. Dispose of in accordance to local-state and federal regulations. For additional information on recycling contact [www.eia.org](http://www.eia.org) (Consumer Education Initiative)

## Waste Electrical and Electronic Equipment-WEEE

Attention users in European Union private households



This marking on the product or on its packaging illustrates that, under European Directive 2012/19/EU governing used electrical and electronic appliances, this product may not be disposed of with normal household waste. You are responsible for disposal of this equipment through a designated waste electrical and electronic equipment collection. To determine the locations for dropping off such waste electrical and electronic, contact your local government office, the waste disposal organization that serves your household or the store at which you purchased the product.

Attention users in United States:

Please dispose of according to all Local, State and Federal Laws. For the disposal or recycling information, contact: [www.mygreenelectronics.com](http://www.mygreenelectronics.com) or [www.eiae.org](http://www.eiae.org).

End of Life Directives-Recycling



Your new Public Information Display contains several materials that can be recycled for new users.

Please dispose of according to all Local, State, and Federal laws.

## Restriction on Hazardous Substances statement (India)

This product complies with the "E-Waste (Management) Rules, 2016" CHAPTER V, rule 16, sub-rule (1) . Whereas New Electrical and Electronic Equipment and their components or consumables or parts or spares do not contain Lead, Mercury, Cadmium, Hexavalent Chromium, polybrominated biphenyls and polybrominated diphenyl ethers beyond a maximum concentration value of 0.1% by weight in homogenous materials for lead, mercury, hexavalent chromium, polybrominated biphenyls and polybrominated diphenyl ethers and of 0.01% by weight in homogenous materials for cadmium. except of exemptions set in Schedule 2 of the Rule.

## E-Waste Declaration for India

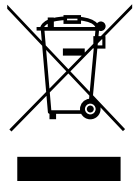

This symbol on the product or on its packaging indicates that this product must not be disposed of with your other household waste. Instead it is your responsibility to dispose of your waste equipment by handing it over to a designated collection point for the recycling of waste electrical and electronic equipment . The separate collection and recycling of your waste equipment at the time of disposal will help to conserve natural resources and ensure that it is recycled in a manner that protects human health and the environment. For more information about E -waste please visit <http://www.india.philips.com/about/sustainability/recycling/index.page> and to know where you can drop off your waste equipment for recycling in India please contact on below given contact details.

Helpline number: 1800-425-6396 (Monday to Saturday, 9 a.m. to 5:30 pm)

E-mail: india.callcentre@tpv-tech.com

## Batteries



For EU: The crossed-out wheeled bin implies that used batteries should not be put to the general household waste! There is a separate collection system for used batteries, to allow proper treatment and recycling in accordance with legislation.

Please contact your local authority for details on the collection and recycling schemes.

For Switzerland: The used battery is to be returned to the selling point.

For other non-EU countries: Please contact your local authority for correct method of disposal of the used battery.

According to EU Battery Regulation (EU) 2023/1542, the battery can't be disposed improperly. The battery shall be separated to collect by local service.



Após o uso, as pilhas e/ou baterias deverão ser entregues ao estabelecimento comercial ou rede de assistência técnica autorizada.



## 2. Unpacking and Installation

### 2.1. Unpacking

- This product is packed in a carton, together with the standard accessories.
- Any other optional accessories will be packed separately.
- As this product is high and heavy, the operation of moving the device is recommended to be performed by two technicians.
- After opening the carton, ensure that the contents are complete and in good condition.

#### ■ Before Unpacking

- Please read and fully understand unpacking notice before installation.
- Please check the packaging for any abnormalities, such as creaking, dents, etc.
- Please do necessary inspection before you move the display out of the carton.
- Always have an experienced technician install the display to prevent any damage.

#### ■ Notice

- For display with handles:
  - Take the display out of the carton box by two adults with both hands.
  - Hold onto the handles when moving the display.

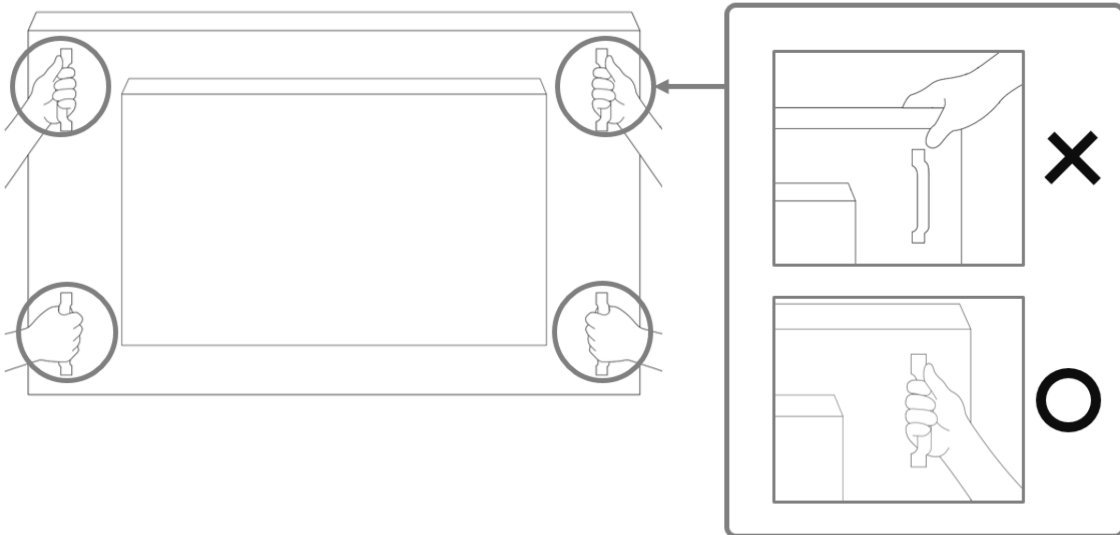

- For display without handle:
  - Take the display out of the carton box by two adults with both hands.
  - Please do not grab or touch the glass of the display.
  - Grasp the bezel surface (plastic or metal) of the display.

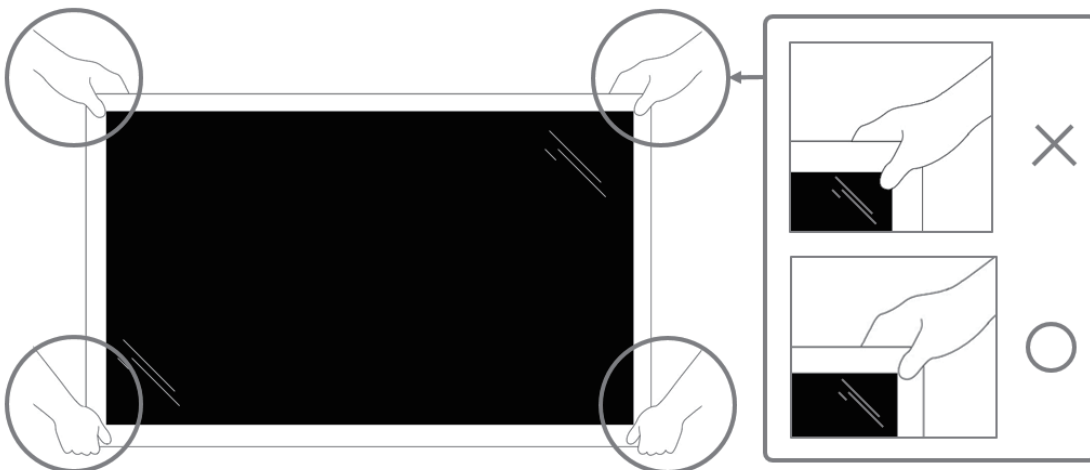

- When removing the display from the box, leave the protective bag inside and take care not to touch the glass of the display to avoid any damage.

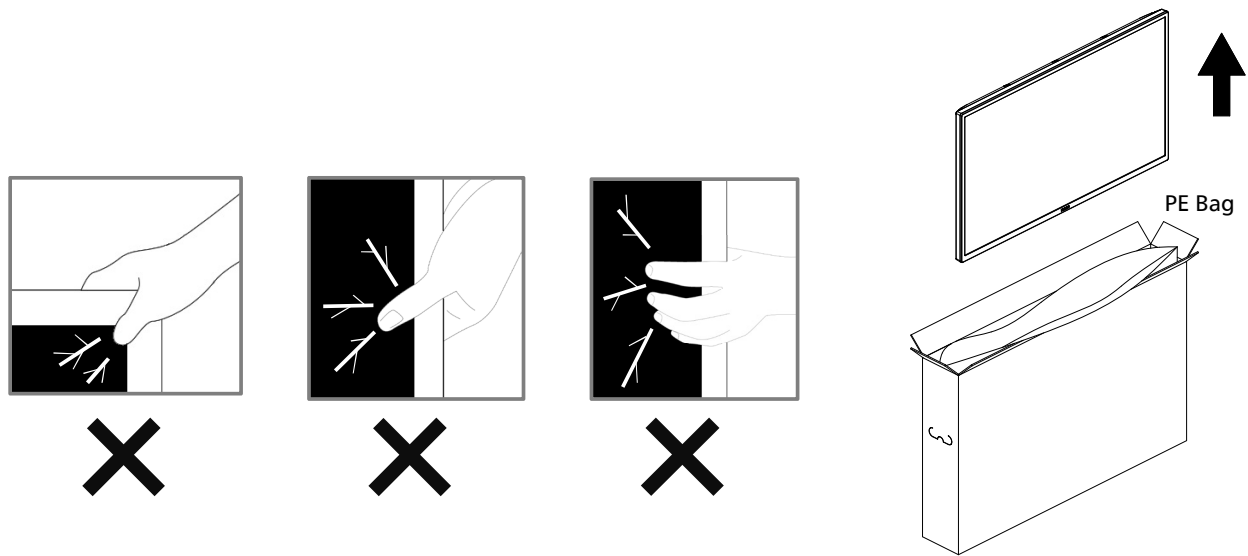

- Please keep the display upright when moving it.

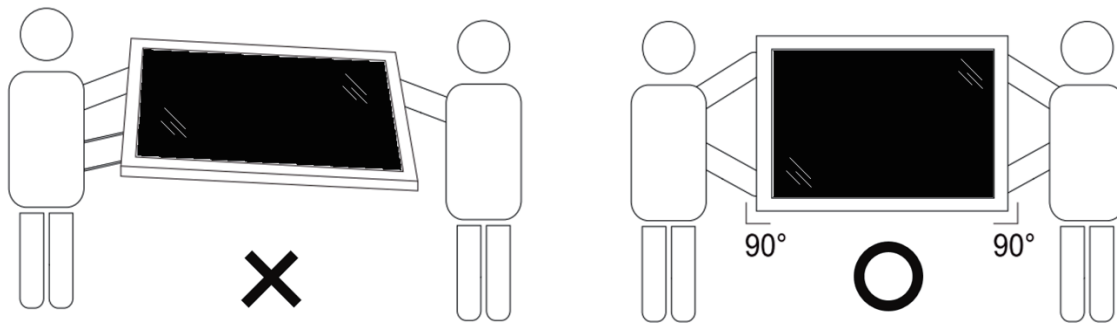

- Place the display vertically and its weight should spread evenly on the surface.

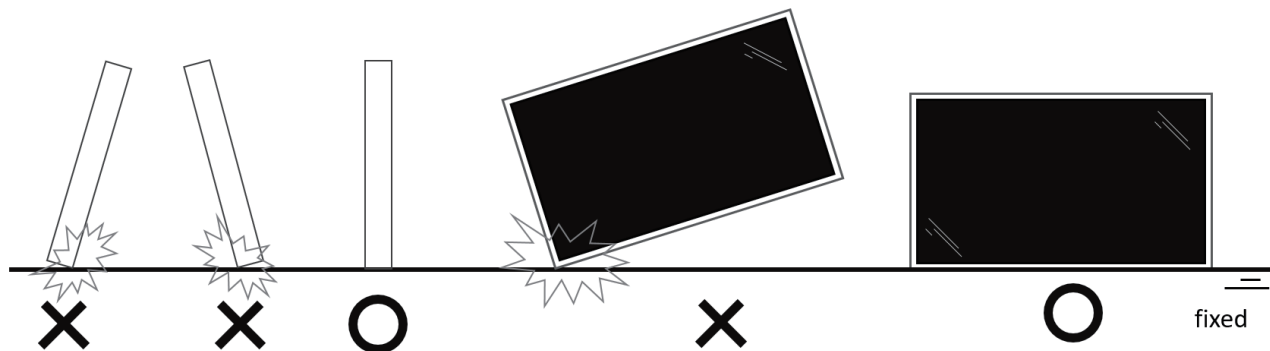

## 2.2. Package Contents

Please verify that you received the following items with your package content:

- LCD Display
- Remote Control and AAA Batteries
- Quick Start Guide
- Power Cord
- Touch USB
- RS232 Cable
- Dipole Antenna x 2PCS
- AC Switch Cover
- Philips Logo Plate

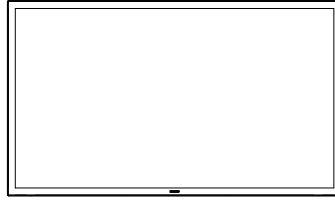

LCD Display

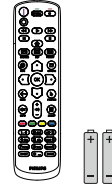

Remote Control  
and AAA Batteries



Quick Start Guide

\* The supplied power cord varies depending on destination.



Power Cord

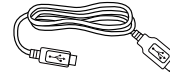

Touch USB

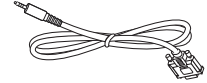

RS232 Cable



Dipole Antenna  
x2PCS

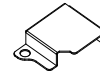

AC Switch  
Cover



Philips Logo  
Plate

\* Items may differ in different locations

\* Display design and accessories may differ from the images shown.

### NOTES:

- For all other regions, apply a power cord that conforms to the AC voltage of the power socket and has been approved by and complies with the safety regulations of the particular country (Type H05W-F, 2G or 3G, 0.75 or 1 mm<sup>2</sup> should be used).
- Keep the packaging materials appropriately after unpacking the product.

## 2.3. Installation Notes

- Only use the power cable provided with this product. If an extension cord is required, please consult your service agent.
- The product should be installed on a flat surface, or the product may tip over. Leave a space between the rear of the product and the wall for proper ventilation. Do not install the product in a kitchen, bathroom or a place exposed to moisture, failure to do so may shorten the life of the internal parts.
- Do not install the product where it is 5000m and higher in altitude. Failure to do so may result in malfunctions.

## 2.4. Mounting on a Wall

To mount this display on a wall, a standard wall-mounting kit (commercially available) is required. It is recommended that you use a mounting interface that complied with TUV-GS and /or UL1678 standard in North America.

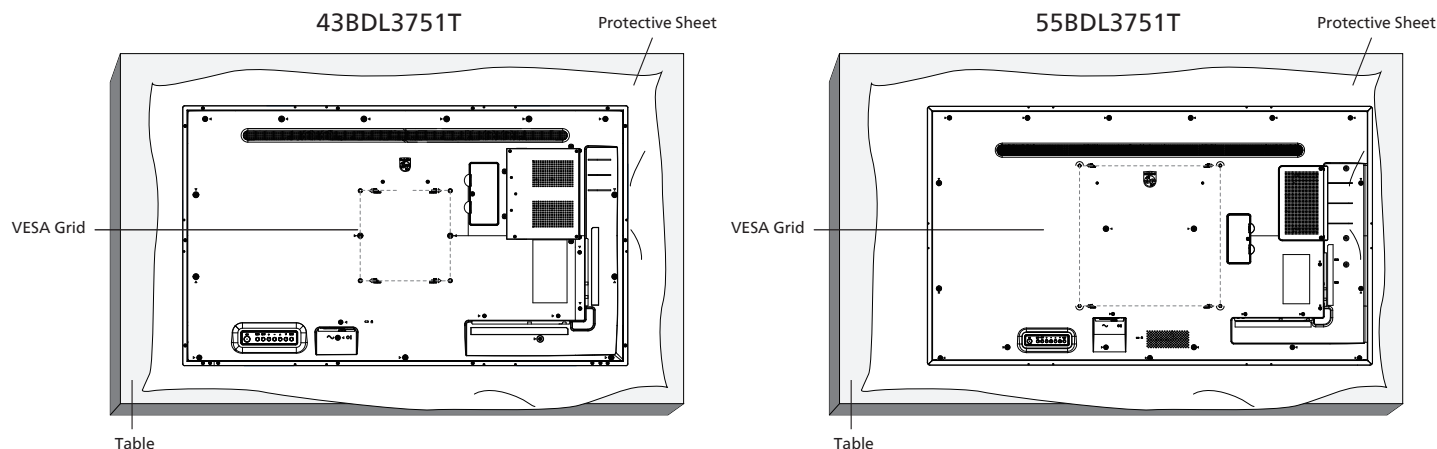

1. Prepare a flat and horizontal surface that is larger than the display and spread a thick protective sheet on it to facilitate your operation without scratching the screen.
2. Ensure you have all accessories for all types of mounting (wall mount, ceiling mount, table stand, etc).
3. Follow the instructions that came with the Wall Mount kit. Failure to follow the correct mounting procedures could result in damage to the equipment, or injury to the user or installer. The product warranty does not cover the damage caused by improper installation.
4. For the wall-mounting kit, use the M6 mounting screws (with a length 10 mm longer than the thickness of the mounting bracket) and tighten them securely.

### 2.4.1. VESA Grid

43BDL3751T	200(H) x 200(V) mm
55BDL3751T	400(H) x 400(V) mm

#### Caution:

To prevent the display from falling:

- For wall or ceiling mounting, we recommend that you install the display with metal brackets which are commercially available. For detailed instructions about the installation, refer to the guide provided with the bracket.
- To prevent the display from falling in case of earthquake or other natural disaster, please consult the manufacturer of the bracket for the mounting location.
- As this product is high and heavy, the installation of this product is recommended to be performed by four technicians.

#### Required space for ventilation

Leave a space of 100 mm at the top, rear, right and left of the display for ventilation.

Note: We recommend you contact a professional technician when installing the display on a wall. We are not responsible for any damage to the product if the installation is not performed by a professional technician.

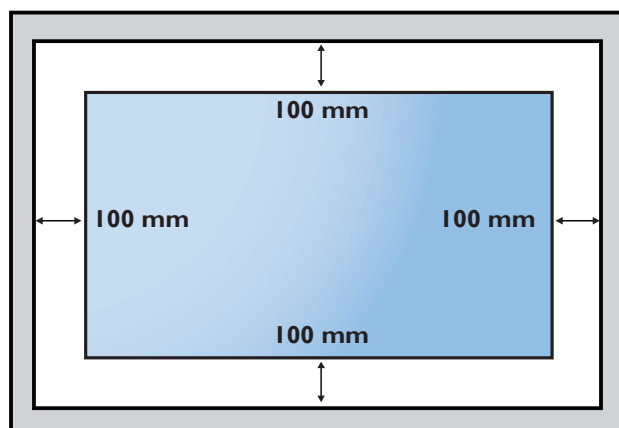

## 2.5. Mounting in Portrait Orientation

This display can be installed in portrait orientation.

Rotate the display 90 degrees counterclockwise. The "PHILIPS" logo should be on the right side when facing the display.

NOTE: The working hour in portrait mode is 24 hours per day.

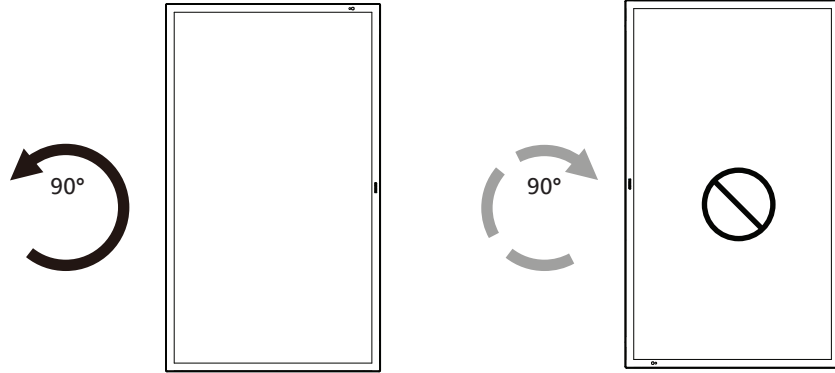

### 2.5.1. How to remove the logo plate

1. Prepare a piece of paper with a cutting area of logo as a protector to prevent the front bezel from scratching.
2. Use a knife and carefully remove the logo sticker with the paper placing beneath.
3. Tear off the logo sticker.

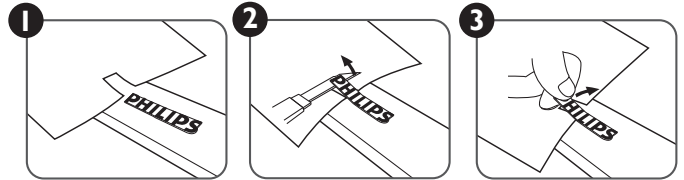

NOTE: We recommend you contact a professional technician when installing the display on a wall. We are not responsible for any damage to the product if the installation is not performed by a professional technician.

## 3. Parts and Functions

### 3.1. Control Panel

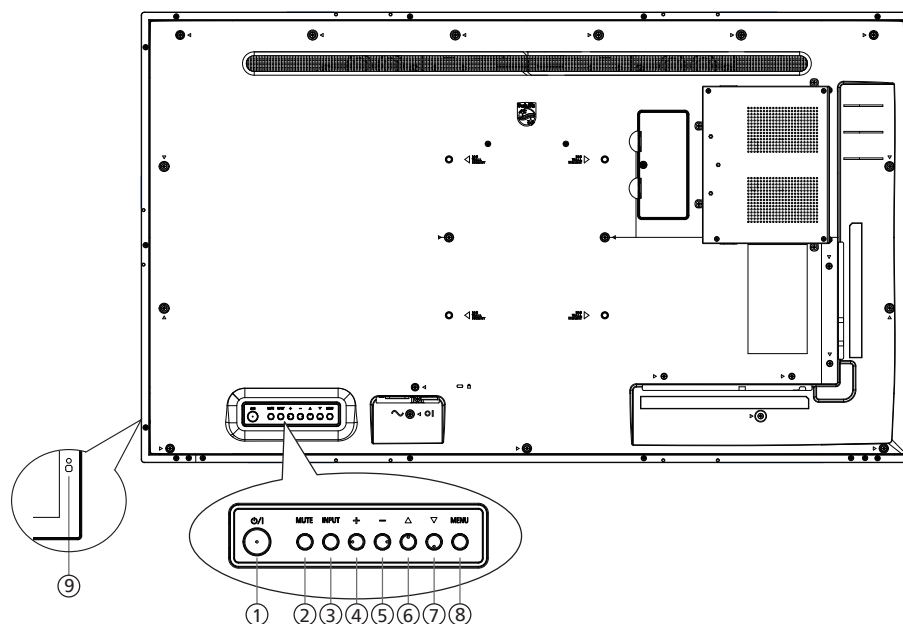

#### ① [⏻/⏻] button

Press this button to turn the display on or put it in standby mode.

#### ② [MUTE] button

Press this button to mute or unmute the sound.

#### ③ [INPUT] button

Select an input source.

#### ④ [⏏] button

Increase the adjustment while OSD menu is On, or increase the audio output level while OSD menu is Off.

#### ⑤ [⏏] button

Decrease the adjustment while OSD menu is On, or decrease the audio output level while OSD menu is Off.

#### ⑥ [▲] button

Move the selected item one level up while the OSD menu is On.

#### ⑦ [▼] button

Move the selected item one level down while the OSD menu is On.

#### ⑧ [MENU] button

Return to the previous menu while the OSD menu is On. This button can also be used to activate the OSD menu when the OSD menu is Off.

#### ⑨ Remote control sensor and power status indicator

- Receive command signals from the remote control.
- Indicate the operating status of the display:
  - Light green when the display is turned On
  - Light red when the display is in the standby mode
  - When {SCHEDULE} is enabled, the light blinks green and red
  - If the light blinks red, it indicates that a failure has been detected
  - Lights off when the main power of the display is turned off

**\* Use an IR sensor cable(optional) for better remote control performance. (Please refer to the instructions on 26)**

## 3.2. Input/Output Terminals

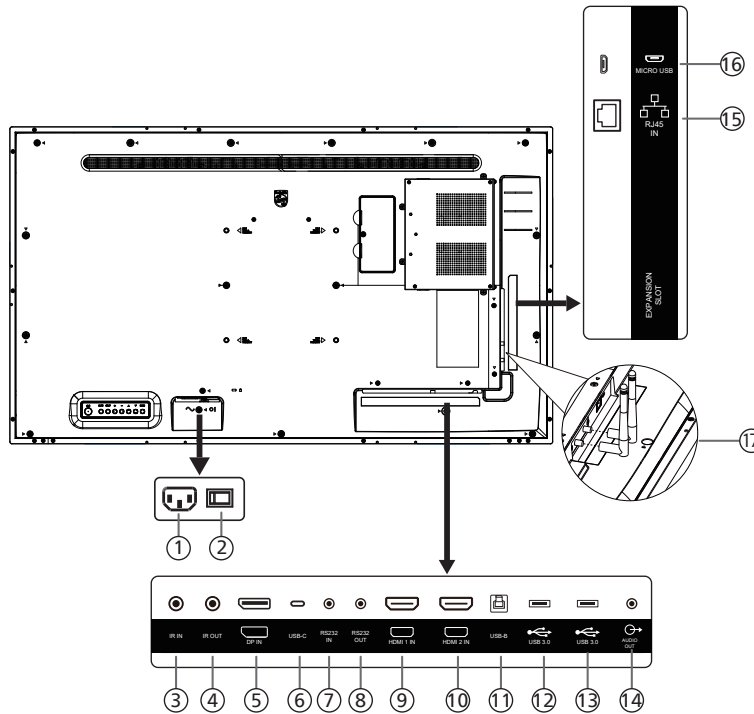

### ① AC IN

AC power input from the wall outlet.

### ② MAIN POWER SWITCH

Switch the main power between On and Off.

### ③ IR IN / ④ IR OUT

IR signal input/output for the loop-through function.

#### NOTES:

- The remote control sensor of this display will stop working if the jack [IR IN] is connected.
- To remotely control your A/V device via this display, refer to page 26 for IR Pass Through connection.

### ⑤ DisplayPort IN

DisplayPort video input.

### ⑥ USB-C

Support display and touch function.

### ⑦ RS232 IN / ⑧ RS232 OUT

Android RS232 network input/output is reserved for customized protocol usage from System Integrator.

### ⑨ HDMI 1 IN

Connect to a source device via an HDMI cable.

### ⑩ HDMI 2 IN

Connect to a source device via an HDMI cable.

### ⑪ USB-B

Touch connector to PC.

### ⑫ USB 3.0

Connect to a USB storage device(Only this port support updating scaler SW firmware).

### ⑬ USB 3.0

Connect to a USB storage device.

### ⑭ AUDIO OUT

Audio output for external AV device.

### ⑮ RJ-45 IN

The LAN control function is used for sending the remote control signal from the control center.

### ⑯ MICRO USB

Support ADB data transmission and OTG.

### ⑰ Wi-Fi Antenna

**To ensure that the Wi-Fi functions properly, please install the provided antenna before starting to use the display.**



### 3.3. Inserting the Batteries in the Remote Control

The remote control is powered by two 1.5V AAA batteries.

To install or replace the batteries:

1. Press and then slide the cover to open it.
2. Insert the batteries with the correct polarity (+) and (-).
3. Replace the cover.

#### Caution:

Incorrect use of batteries may cause leakage or explosion. Be sure to follow the instructions below:

- Insert "AAA" batteries with the correct polarity (+ and -).
- Do not mix battery types.
- Do not use a new battery with a used one together. Otherwise, it may cause leakage or shorten the life of the batteries.
- Remove the dead batteries immediately to avoid battery leakage in the battery compartment. Do not touch exposed battery acid, as it may cause injury to your skin.
- Disposal of a battery into fire or a hot oven, or mechanically crushing or cutting of a battery, that can result in an explosion; leaving a battery in an extremely high temperature surrounding environment that can result in an explosion or the leakage of flammable liquid or gas; and a battery subjected to extremely low air pressure that may result in an explosion or the leakage of flammable liquid or gas.

Note: Remove the batteries from the battery compartment when not using for an extended period of time.

### 3.4. Handling the Remote Control

- Do not drop or apply shock to the remote control.
- Do not allow any liquid to get inside the remote control. If water has entered the remote control, wipe the remote control with a dry cloth immediately.
- Do not place the remote control near heat and steam sources.
- Do not attempt to disassemble the remote control, unless you need to place batteries in the remote control.

### 3.5. Operating range of the Remote Control

Point the top front of the remote control at the remote sensor on the display when you press the buttons.

Use the remote control within a distance of less than 4m/16ft from the display's sensor, and a horizontal and vertical angle of less than 20°.

Note: The remote control may not function properly when the remote control sensor on the display is under direct sunlight or strong illumination, or when there is an object between the remote control and the remote sensor of the display.

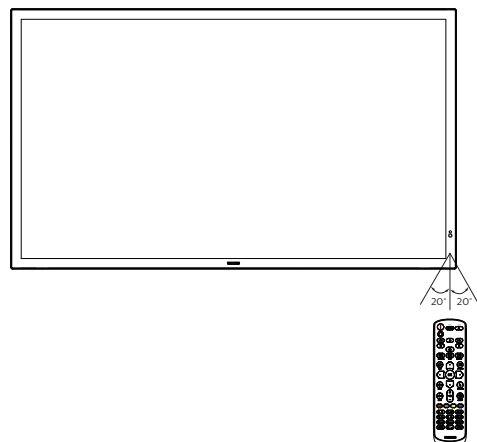

## 3.6. Remote Control

### 3.6.1. General functions

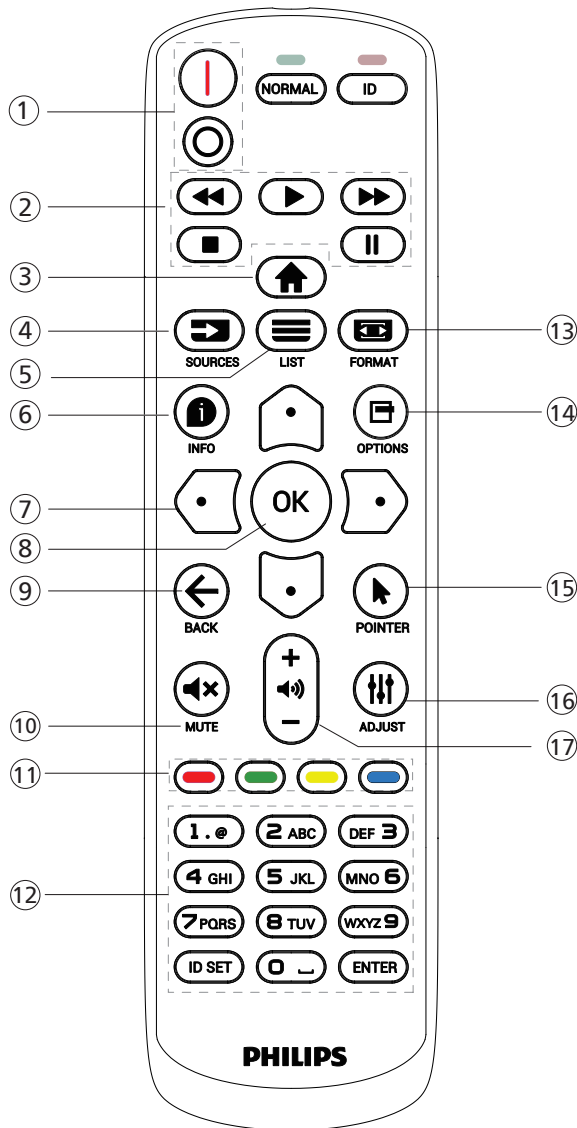

#### ① [I/O] POWER button

[I] Turn the power On.  
[O] Turn the power Off.

#### ② [PLAY] buttons

Control playback of media files.(for Media Input only)  
Freeze feature  
Pause: hotkey for freezing all inputs content.  
Play: hotkey for unfreezing all input content.

#### ③ [HOME] button

Root Menu: Access the OSD menu.  
Others: Exit the OSD menu.

#### ④ [SOURCE] button

Root Menu: Choose input source.

#### ⑤ [LIST] button

Reserved.

#### ⑥ [INFO] button

Show Information OSD.

#### ⑦ NAVIGATION buttons



Root Menu: Go to the OSD of Smart picture.  
Main Menu: Move the selected item up to make adjustment.  
IR Daisy Chain Menu: Increase the controlled Group ID number.



Root Menu: Go to the OSD of Audio source.  
Main Menu: Move the selected item down to make adjustment.

IR Daisy Chain Menu: Decrease the controlled Group ID number.



Main Menu: Go to the previous level of menu.

Source Menu: Exit from the source menu.

Volume Menu: Decrease the volume.



Main Menu: Go to the next level of menu or set selected option.

Source Menu: Go to the selected source.

Volume Menu: Increase the volume.

#### ⑧ [OK] button

Root Menu: Go to the OSD of IR daisy chain in Primary/ Secondary mode.

Main Menu: Confirm an entry or selection.

#### ⑨ [←] BACK button

Return to the previous page or exit from the previous function.

#### ⑩ [MUTE] button

Mute or unmute the sound.

#### ⑪ [RED] [GREEN] [YELLOW] [BLUE] COLOR buttons

[BLUE] Hotkey to turn on and off backlight.

#### ⑫ [Number/ ID SET/ ENTER] button

Enter text for network setting.

Press to set the display ID. Refer to 3.6.2. ID Remote Control for more details.

#### ⑬ [FORMAT] button

Select image zoom mode.

#### ⑭ [OPTIONS] button

Reserved.

#### ⑮ [POINTER] button

Reserved.

#### ⑯ [ADJUST] button

Go to the OSD of Auto Adjust (for VGA only).

#### ⑰ [−] [+] VOLUME button

Adjust the volume.

### 3.6.2. ID Remote Control

Set remote control ID number when using several displays.

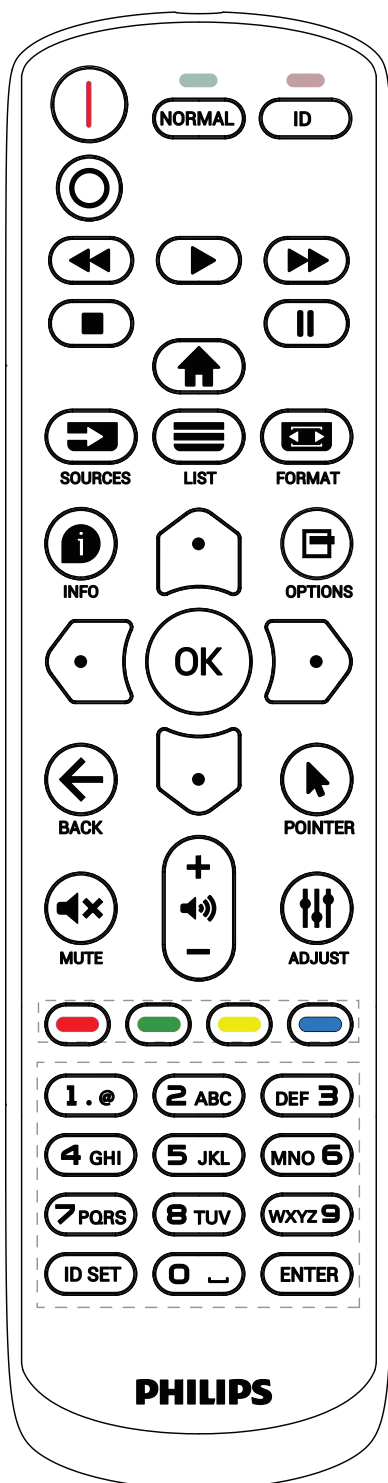

Press the [ID] button and the red LED blinks twice.

1. Press [ID SET] button for more than 1 second to enter the ID Mode. The red LED lights up.  
Press the [ID SET] button again will exit the ID Mode. The red LED lights off.

Press the digit numbers [0] ~ [9] to select the display to be controlled.

For example: press [0] and [1] for display No.1, press [1] and [1] for display No.11.

The numbers available are [01] ~ [255].

2. If no button is pressed within 10 seconds, it will exit from the ID mode.
3. If a wrong button is pressed, wait for 1 second until the red LED lights off and then turns on again, then press the correct digits.
4. Press [ENTER] button to confirm your selection. The red LED blinks twice and then lights off.

#### NOTE:

- Press [NORMAL] button. The green LED blinks twice, indicating that the display is under normal operation.
- It is necessary to set up the ID number for each display before selecting its ID number.

### 3.6.3. Remote Control buttons on Android source

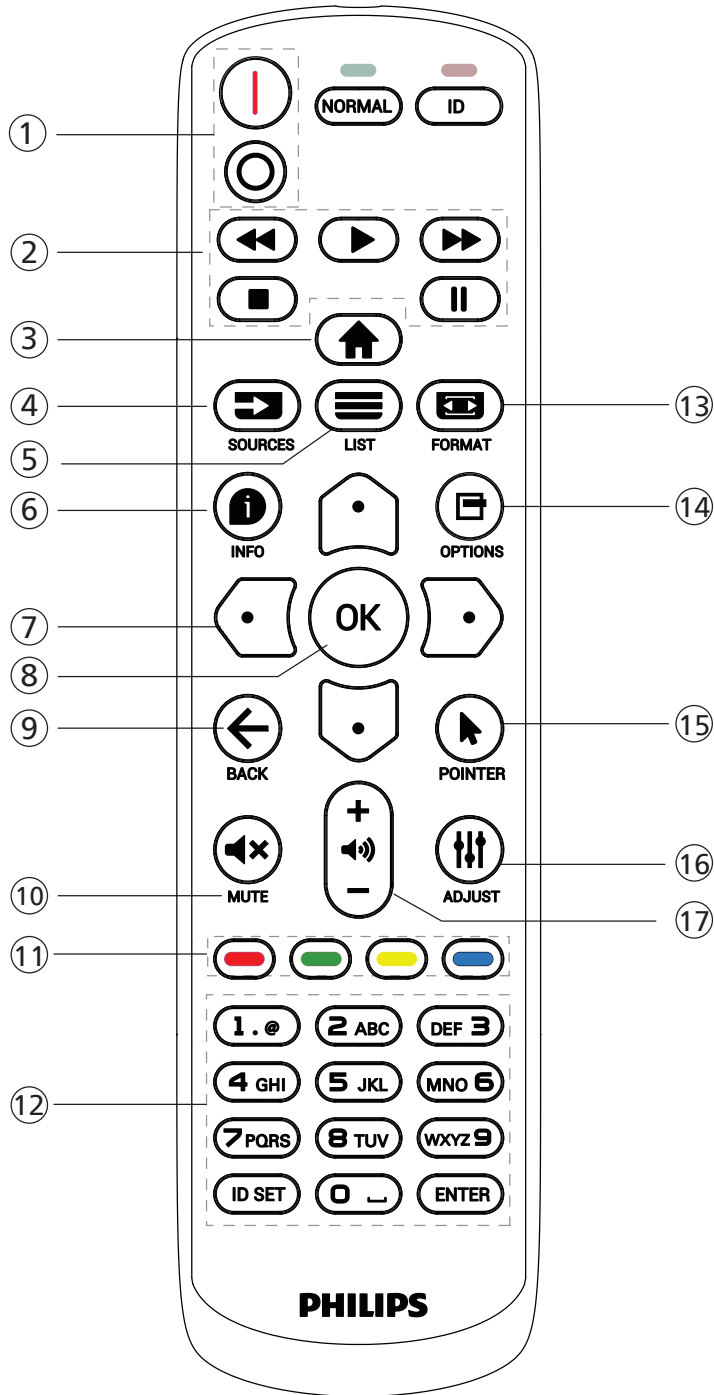

#### ① [I/O] POWER button

Turn the display On or standby mode.  
The button is only controlled by Scalar.

#### ② [PLAY] buttons

1. Control playback of media (video/audio/picture) files.  
There are 4 ways to play the media files.

1) File Manager

Find the media file from the File Manager and select it to play.

2) Media Player -> Compose -> edit or add a new playlist -> choose any media files -> press button to play the media file directly.

3) Media Player -> Play -> choose non-empty play list -> press to play all media files from the playlist.

4) Set media playlist in Boot on Source or Schedule by OSD menu.

2. When playing a video or music file, you can press button to stop playing. If you press again, playback will be started from the beginning of the file.

3. When playing a video or music file, you can press button to pause playing.

4. All media files should be located in the folder of "philips", under the root directory of the specified storage (internal/USB/SD Card). All sub-folders (video/photo/music) are named by media types and shouldn't be changed.

videos: {root dir of storage}/philips/video/

photos: {root dir of storage}/philips/photo/

music: {root dir of storage}/philips/music/

Note that the root directories of three storages are

Internal storage: /sdcard

USB storage: /mnt/usb\_storage

SD card : /mnt/external\_sd

#### ③ [HOME] HOME button

Access the OSD menu.  
The button is only controlled by Scalar.

#### ④ [SOURCE] SOURCE button

Select an input source.  
The button is only controlled by Scalar.

#### ⑤ [LIST] LIST button

1. In the content of the web page, move the focus up to the next selectable items.

2. Move the focus up to the next control or widget such as buttons.

#### ⑥ [INFO] INFO button

1. Display information about the current input signal. It is shown by Scalar.

2. Media Player -> Compose -> edit or add a new playlist -> choose any media files -> press to show the information of the selected media file.

#### ⑦ [NAVIGATION] buttons

1. Navigate through the menus and select an item.

2. In the content of the web page, these buttons are for controlling the scroll bar of the screen. Press or for moving the vertical scroll bar up or down. Press or for moving the horizontal scroll bar left or right.

#### ⑧ [OK] button

Confirm an entry or selection.

**⑨ [← ] BACK button**

Return to the previous page or exit from the previous function.

**⑩ [⏏] MUTE button**

Mute or unmute the sound.

The button is only controlled by Scalar.

**⑪ [■] [■] [■] [■] COLOR buttons**

[■] Hotkey to turn on and off backlight.

**⑫ [Number/ ID SET/ ENTER] button**

ID SET  and ENTER  are reserved on Android source. These buttons are only controlled by Scalar.

**⑬ [🖼️] FORMAT button**

Change picture format. The button is only controlled by Scalar.

**⑭ [🔧] OPTIONS button**

Open the toolbox from Media Player.

1. Media Player ->Compose -> Edit or add a new playlist -> press  to open a toolbox. The toolbox will slide from the left side of the screen.

**⑮ [👉] POINTER buttons**

Reserved.

**⑯ [⏴] ADJUST button**

1. In the content of the web page, move the focus down to the next selectable items.

2. Move the focus down to the next control or widget such as buttons.

**⑰ [—] [+] VOLUME button**

Adjust volume level. The buttons are only controlled by Scalar.

### 3.7. AC Switch Cover

- Use AC Switch Cover to cover the AC switch.
1. Release the screw.
  2. Install the AC Switch Cover.
  3. Fix the AC Switch Cover with the screw in step1.

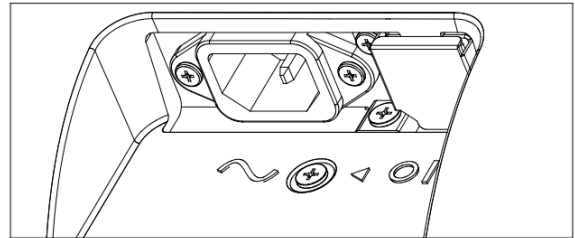
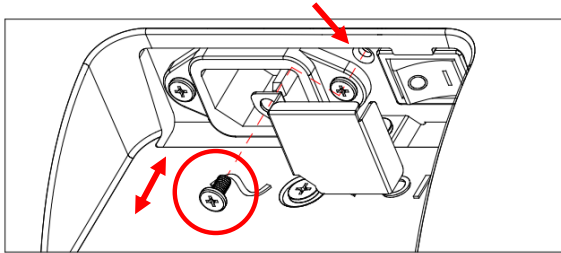

### 3.8. Open Frame Kit(Optional)

- You can use the Open Frame Kit to mount the display to the frame of kiosk.
- Please ask for the assistance of the professional to install the display with the Open Frame Kit.
- Please make sure the strength of the frame is strong enough to withstand a 50Kg loading of display.
- Follow the following drawing to have the screw holes for the Open Frame Kit.(Total 12\*M3 Screw Holes ).
- Fix Open Frame Kit with the M3 screw from the kit.

Note: The CTN for the 24"/32" sizes is BM03752, and the CTN for the 43"/55" sizes is BM03751. Please use the correct CTN to identify and order the corresponding open frame kit.

43BDL3751T

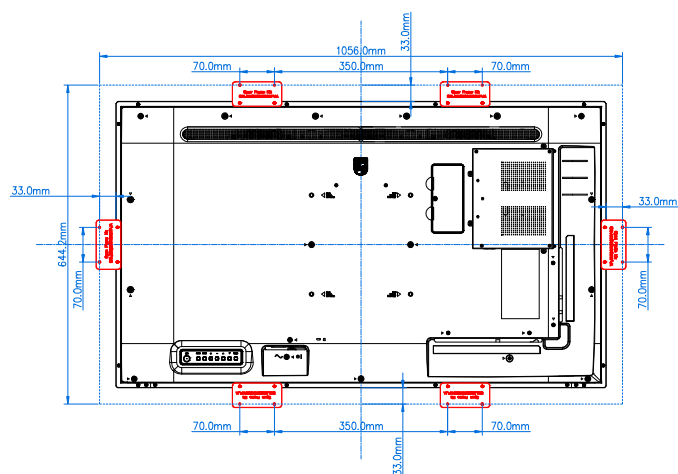

55BDL3751T

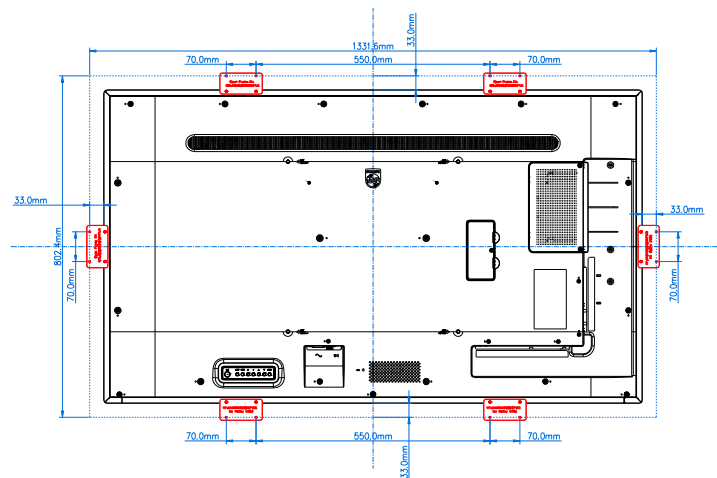



## 4. Connecting External Equipment

### 4.1. Connecting External Equipment (Multimedia Player)

#### 4.1.1. Using HDMI video input

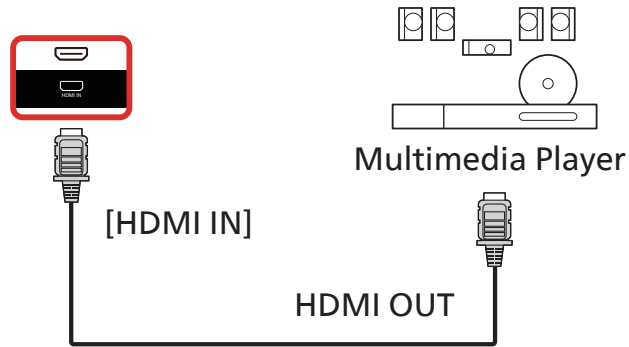

### 4.2. Connecting a PC

#### 4.2.1. Using HDMI input

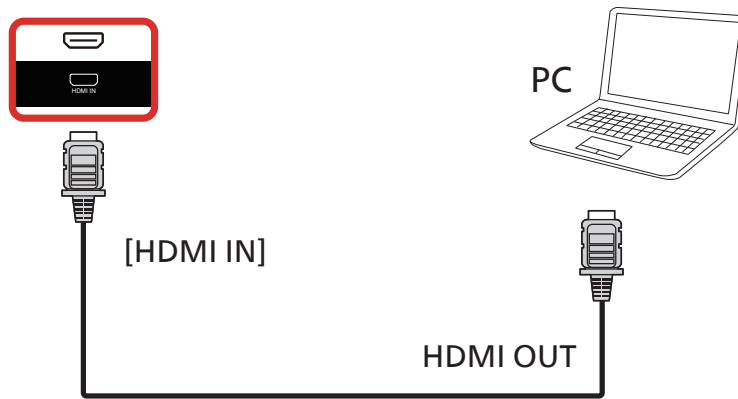

#### 4.2.2. Using DisplayPort input

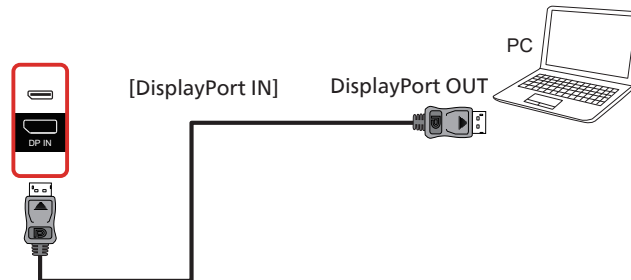

### 4.2.3. Using HDMI input with USB-B (touch connector to PC)

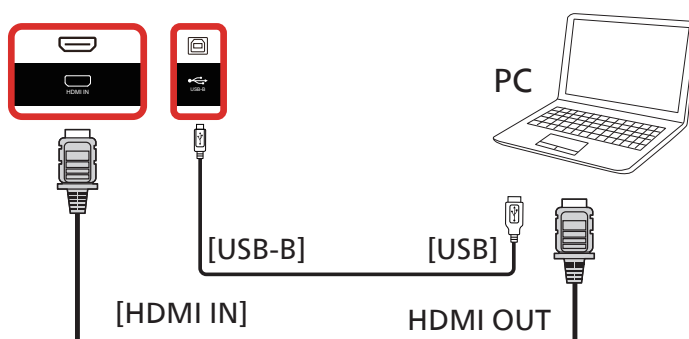

## 4.3. Connecting Audio Equipment

### 4.3.1. Connecting an external audio device

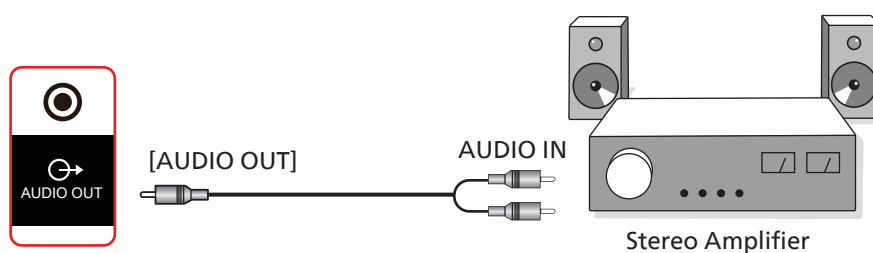

## 4.4. Connecting Multiple Displays in a Daisy-Chain Configuration

You can interconnect multiple displays to create a daisy-chain configuration for applications such as a menu board.

### 4.4.1. Display control connection

Connect the [RS232 OUT] connector of DISPLAY 1 to the [RS232 IN] connector of DISPLAY 2.

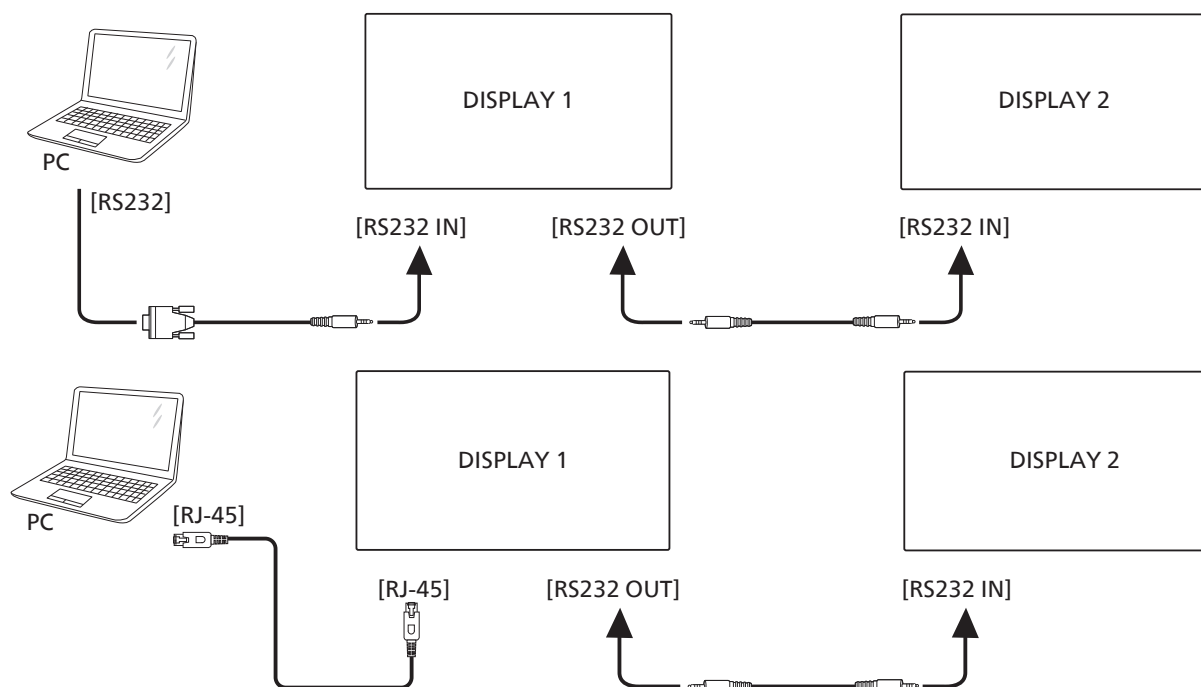

### 4.5. IR Connection

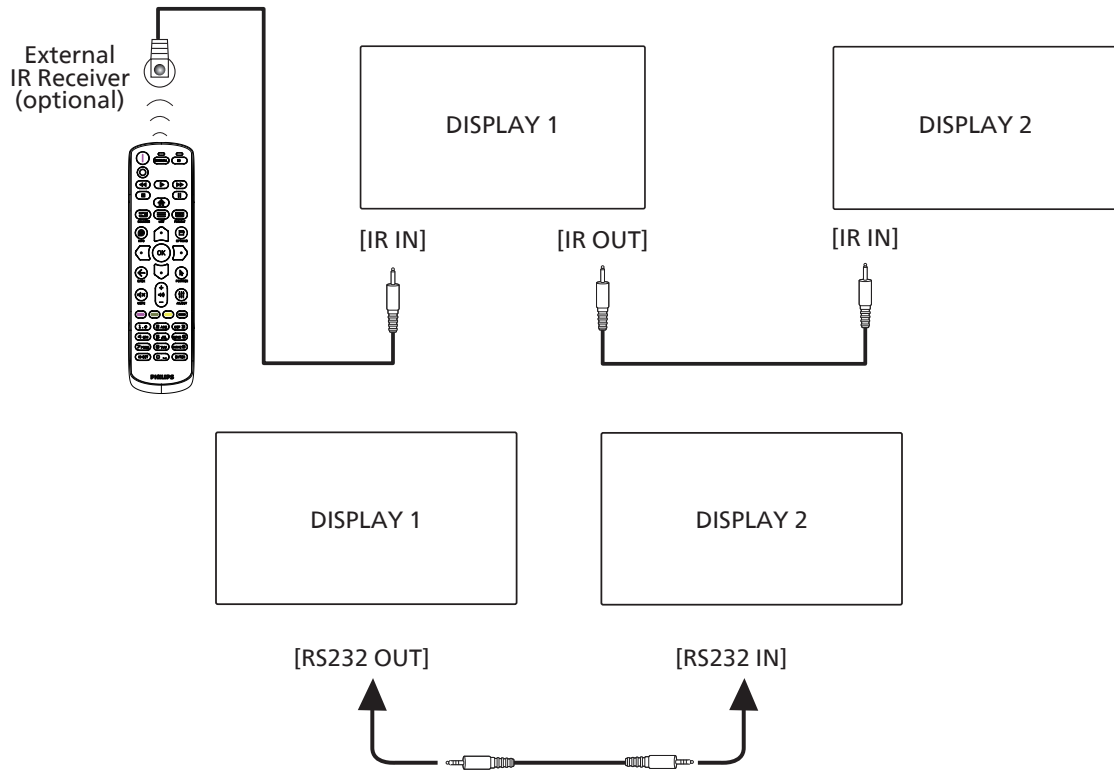

**NOTE:**

1. The remote control sensor of this display will stop working if the [IR IN] is connected.
2. IR loop through connection can support up to 9 displays.
3. IR in daisy chain via RS232 connection can support up to 9 displays.

### 4.6. IR Pass-through Connection

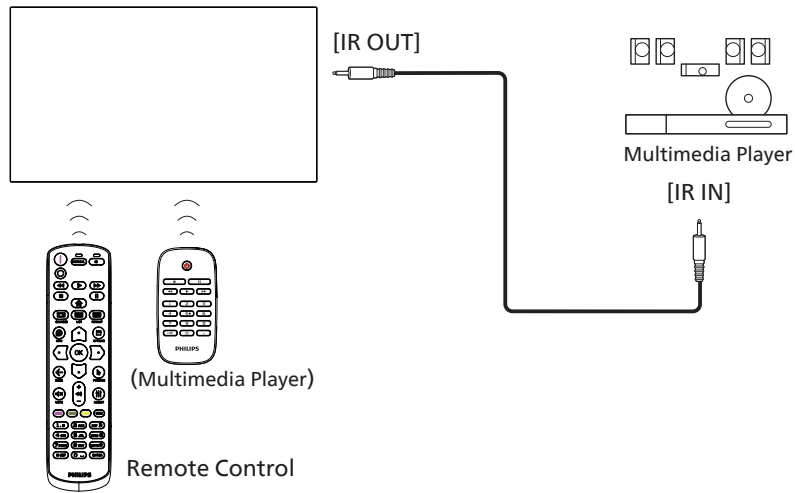

## 4.7. Touch Operation

This display is equipped with a touch-sensitive screen and supports the Windows Touch features either by single touch or multi-touch operation. You can touch the pictures or text on the display gently with your fingers, and the system will react.

This section explains about the touch operation on the display. For further detail on how to run the touch operation, please refer to the Windows operation instruction.

### Single Tap

Touch the target on the screen with one fingertip for one quick tap, then release.

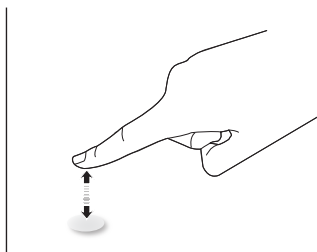

Please note that a touch screen will respond to a light touch from your fingertip when tapping on touch screen.

### Double Tap

Touch the target on the screen with one fingertip for two quick taps, then release.

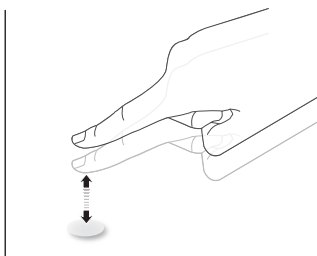

### Pan

Touch the target on the screen with one fingertip and move across the target without losing direct contact, then release.

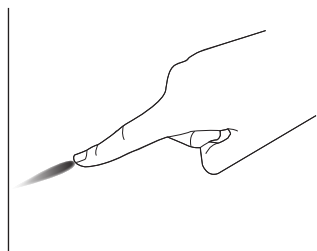

### Flick

Touch the target on the screen with one fingertip and brush the surface quickly.

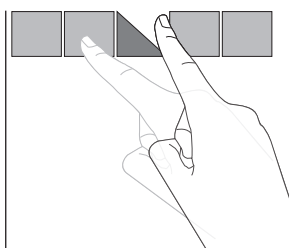

### Zoom in

Touch the target on the screen with two fingertips held together and move them apart to zoom in (magnify) the screen image.

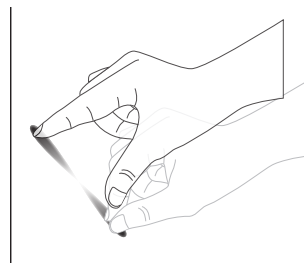

### Zoom out

Touch the target on the screen with two fingertips stretched apart and move them closer to zoom out (shrink) the screen image.

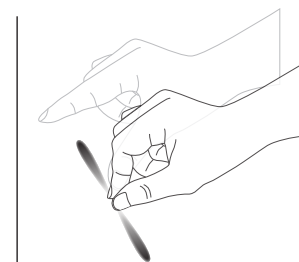

### Touch and Hold

Touch and hold the target on the screen with one fingertip for a while to display a context menu or options page for an item.

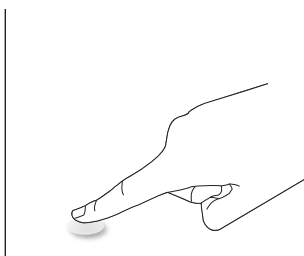

The multi Touch function is not supported by Mac OS. The OS supported is listed below.

Item	Description		
Operating Systems Supported by Plug-and-Play	Windows 7, 8/8.1, 10,11		
Supported Modes of Operation by the Operating System	OS	Single Touch	Multi Touch
	Windows 7, 8/8.1, 10,11	O	O*
	Mac OS before (include) 10.15	O	X
	Mac OS after (include) 10.10	O	X
	Chrome 38+	O	O**
	Android 4.0, Kernel after (include) 3.6	O	O***
	Linux	O****	O*****
	* Support multi-touch. ** Kernel 3.15 upward. *** Support 10-point touch. **** CentOS, Debian, Fedora, Gentoo, Mandrake(Mandriva), Meego, Red Hat, Slackware, SuSE(OpenSuSE), Ubuntu(Xubuntu), and Yellow Dog etc. ***** Kernel 3.15 upward.		

1. We highly recommend that you use the latest Service Pack with all Windows 7 OS.
2. Set as default by Microsoft.

## 5. Operation

Note: The control button described in this section is mainly on the remote control unless specified otherwise.

### 5.1. Watch the Connected Video Source

1. Press the [↔] SOURCE button.
2. Press [↵] or [⏪] button to select a device, then press [OK] button.

### 5.2. Change Picture Format

You can change the picture format to suit the video source. Each video source has its available picture formats.

The available picture formats depend on the video source:

1. Press [📺] FORMAT button to select a picture format.
  - PC mode: {Full} / {4:3} / {Real} / {21:9} / {Custom}.
  - Video mode: {Full} / {4:3} / {Real} / {21:9} / {Custom}.

### 5.3. Overview

1. Android PD launcher:
  - Android PD launcher as shown below:

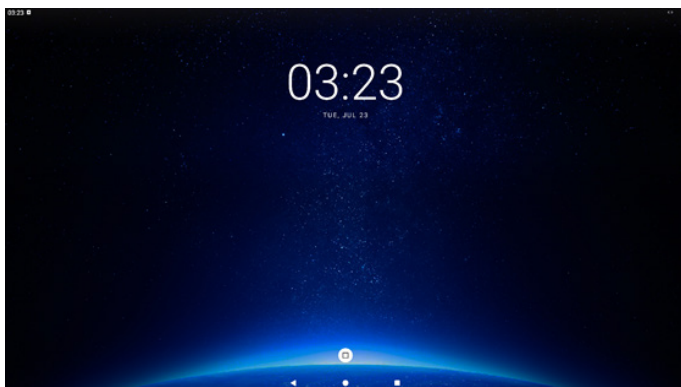

- Exit the App by pressing the "Back" key and the screen will enter Android PD launcher.
2. Admin mode:
    - Press "Home + 1888" to enter the Admin mode. Please make sure that you see the Home OSD menu after "Home" is pressed, and then press 1888 in sequence. Two continuous "Home" keys will not be a valid hotkey.
    - The Admin mode consists of the following Apps: "Settings".
    - When leaving from the Admin mode, the system will return to last source.

Settings: go to Settings page.

#### 1) Settings page:



#### 3. Application page

- When you Single Tap on the Android PD launcher, Application page will be shown:

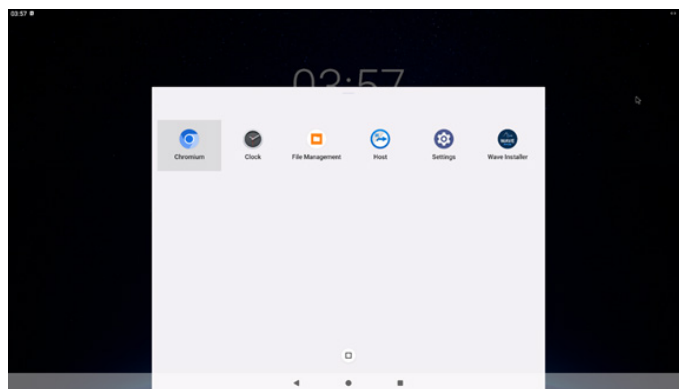

## 5.4. Media Player

### 5.4.1. OSD menu interaction with media player:

1. Boot on source:
  - Input:
    - If you select Media player as the source, the system will enter media player automatically after the boot process is completed.
  - Playlist:
    - Playlist 0: go to the main page of media player.
    - Playlist 1 - Playlist 7: go to media player and playback File1 - File7 of playlist automatically
    - Playlist 8: Plug in the USB device and it will play the files from USB root path automatically..
2. Schedule:
  - Schedule list:
    - Set up to 7 schedules.
  - Enable:
    - Enable/disable schedule.
  - Start time:
    - Set start time.
  - End time:
    - Set end time.
  - Playlist:
    - 1-7 : go to media player and playback File1 - File7 of playlist automatically.
  - Days of the week:
    - Set Sunday, Monday, Tuesday, Wednesday, Thursday, Friday, Saturday.
  - Every week:
    - Set a weekly schedule.
  - Save:
    - Save the schedule.

### 5.4.2. Media Player introduction:

1. The main page of Media Player, this page consists of three options: "Play", "Compose" and "Settings".  
 Play: select a playlist to play.  
 Compose: edit a playlist.  
 Settings: set the properties of Media Player.

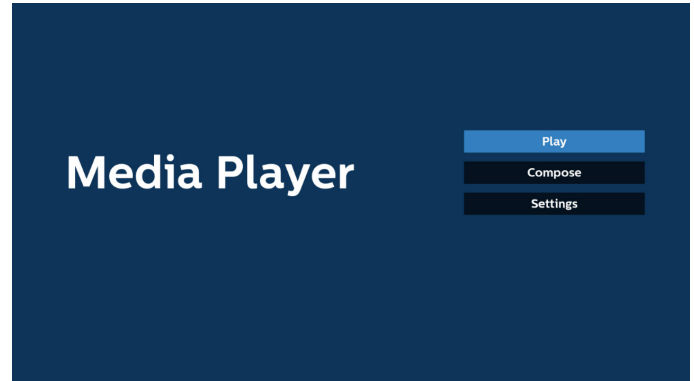

2. Select "Play" on the main page. Then, you should choose one playlist to play between FILE 1 and FILE 7. The pencil icon means that the playlist contains the content.



3. Select "Compose" on the main page, first you should select one playlist to edit between FILE 1 and FILE 7. The pencil icon means that the playlist contains the content.

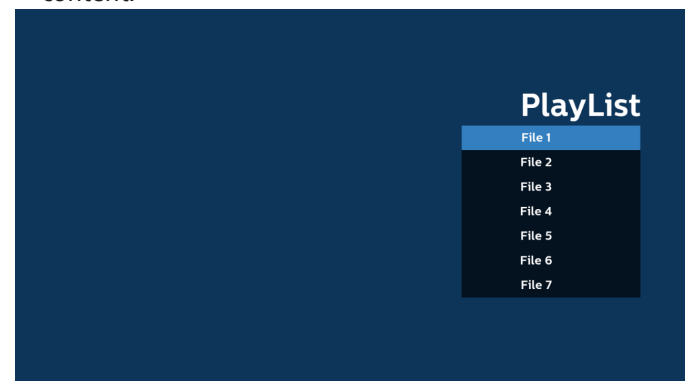

4. If an empty playlist is selected, the App will guide you through selecting the media source.  
 All media files should be stored in /philips/ of root directory.  
 For example,  
**videos: {root dir of storage}/philips/video/**  
**photos: {root dir of storage}/philips/photo/**  
**music : {root dir of storage}/philips/music/**



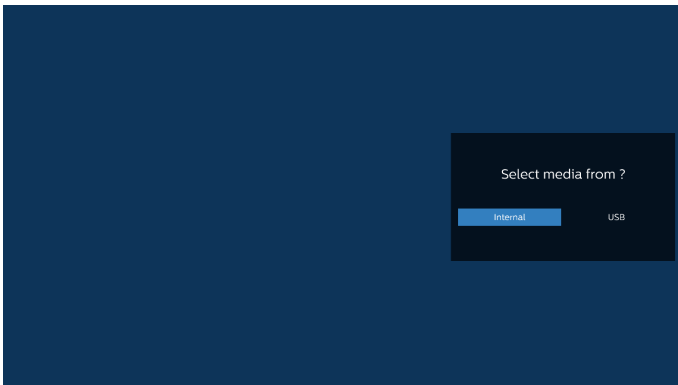

5. If you select "USB" storage, the App will guide you through selecting the USB device.

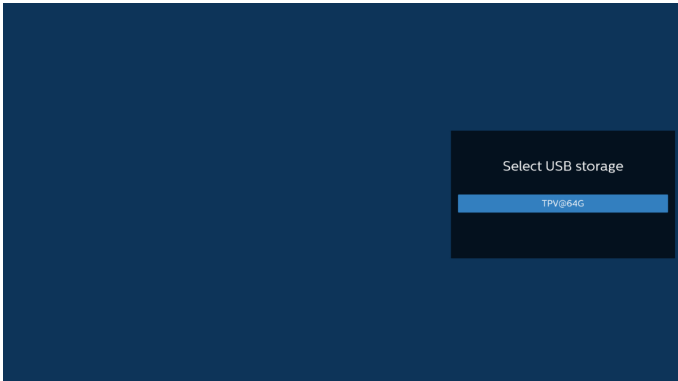

6. To edit or delete a non-empty playlist, select the desired playlist that has a pencil icon on right side of the selected file.

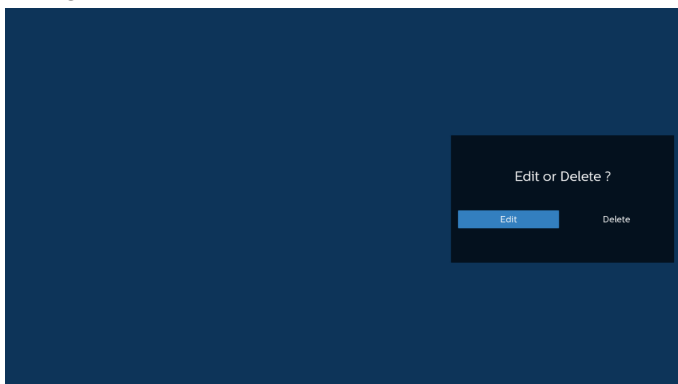

7. Once you start to edit a playlist, you will see below screen.  
 Source - files in storage.  
 Playlist – files in playlist.  
 Option – launch the side menu bar.  
 Play key – play the media file.  
 Info key – show the media information.  
 Touch file - select/deselect a file.

**Note:**

When long press on one of the directories in Source, full path will then be displayed.

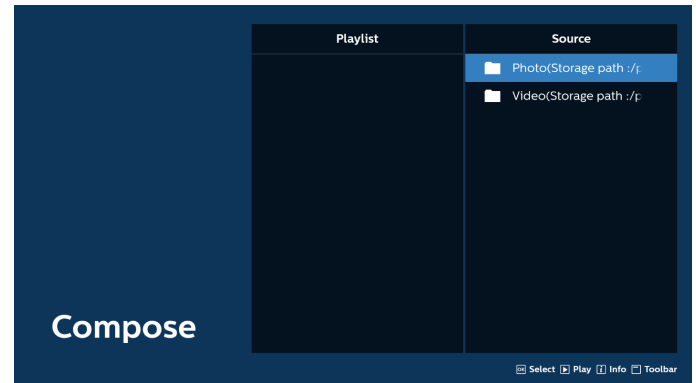

- 7-1 From the side menu bar, the following functions are available:

- select all: select all storage files.
- delete all: delete all playlist files.
- add/remove: update playlist from source.
- sort: sort playlist.
- save/abort: save or abort playlist.
- back: return to the previous menu.

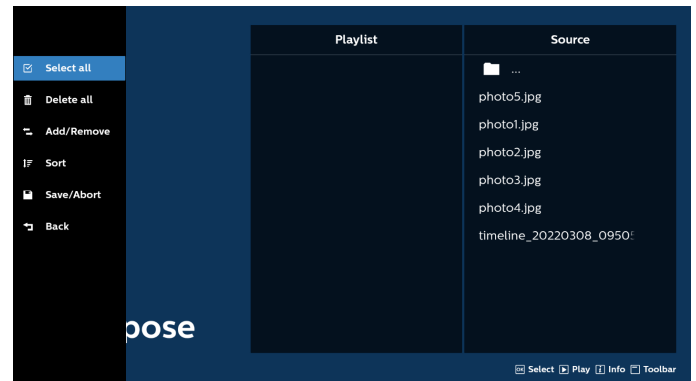

8. If "Sort" is selected, you can customize the file order severally.



9. After selecting the desired file, press "Info" key to obtain the detailed information.

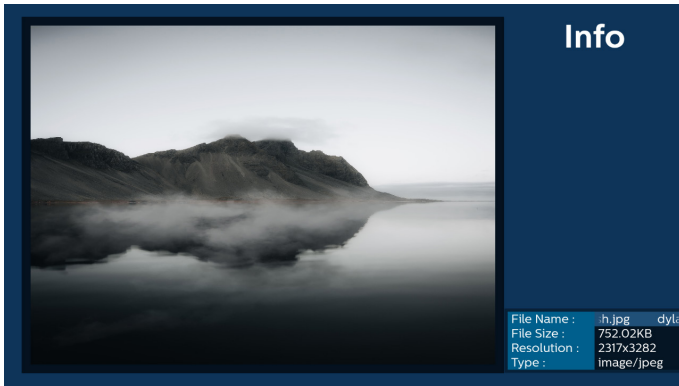

10. After selecting the desired file, press "Play" key to play the media file immediately.



11. If you create a playlist with all image files, you will be asked to add a background music to the slideshow before saving.

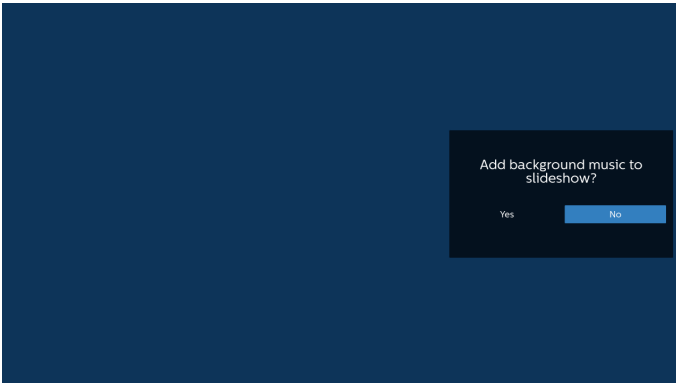

12. Select "Settings" on the main page, there are 5 options available: "Repeat Mode", "Slideshow Effect", "Effect Duration", "Software Decode" and "Autoplay".
- Repeat mode: set the repeat mode.
  - Slideshow Effect: photo slideshow effect.
  - Effect Duration: duration of photo effect.
  - Software Decode: no black screen between video play.
  - Autoplay: Plug in the USB device and it will play the files from USB root path automatically.

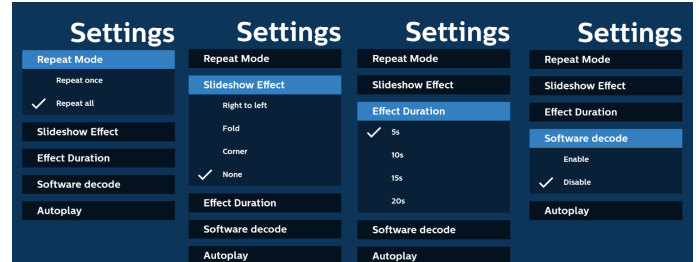

13. Media Player import text file

Step 1. Create media player text file.

- File name : mpplaylistX.txt, "X" means playlist number(1,2,3,4,5,6,7).

Ex. mpplaylist1.txt, mpplaylist2.txt

- Content :

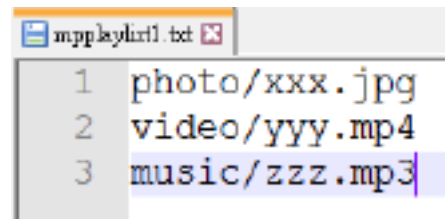

Note: If the playlist contains video and music files, the screen becomes black when playing music file.

Step 2. Copy "mpplaylistX.txt" to "philips" folder of internal storage. You may use SFTP to do this.

- File path : /storage/emulated/legacy/philips (for DL, PL)
- Ex. /storage/emulated/legacy/philips/mpplaylist1.txt

Step 3. Prepare media files to "photo", "video" and "music" folder under "philips" folder, internal storage only.

- Ex. /storage/emulated/legacy/philips/photo/xxx.jpg
- /storage/emulated/legacy/philips/video/yyy.mp4
- /storage/emulated/legacy/philips/photo/zzz.mp3

Step 4. Start media player app, it will automatically import media player text file.

Note: Once the playlist file (text) is imported, if user changes playlist via remote control, this change will not be reflected in the playlist text file.

## 5.5. Browser

Before using this feature, ensure that the system is connected successfully to the network.

1. Main page of "Browser" App which allows you to make related settings.



2. Press "Compose" then enter the next page. Users can choose between 1~7. A dialog box appears after the selection is made.

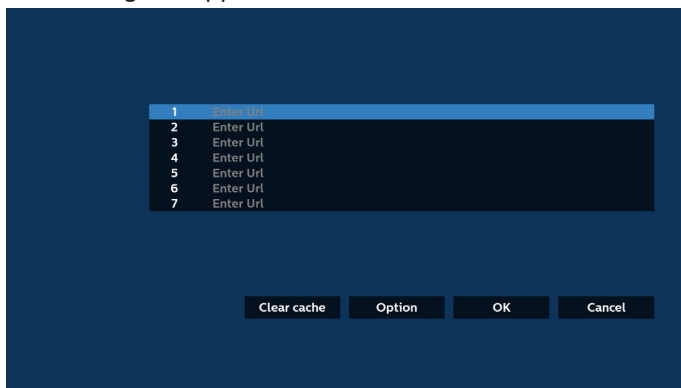

3. Use the on-screen keyboard to enter URL and press the OK button, the data will be saved in the List.

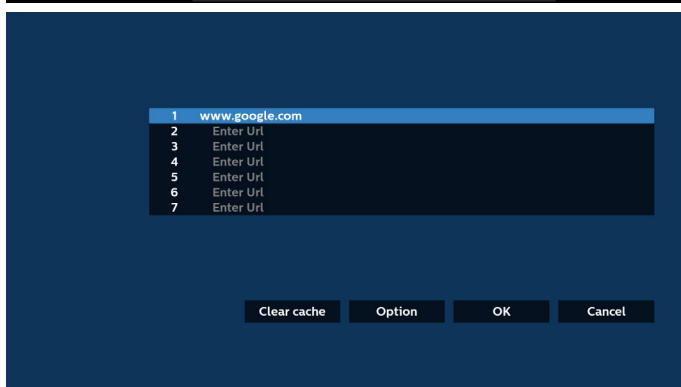
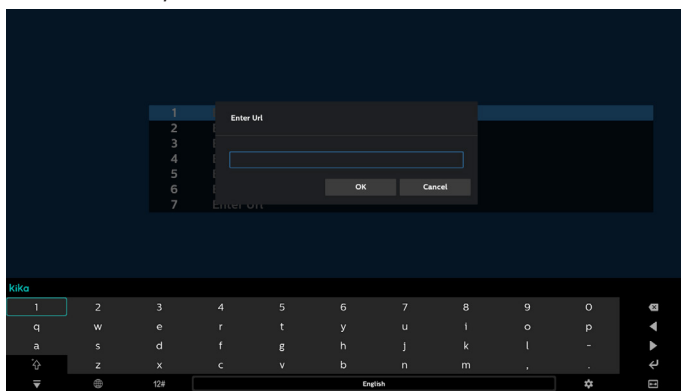

4. Press "Option" and a list will appear on the left side.
  - Import: Import the file of URL list
  - Export: Export the file of URL list
  - Delete all: Delete all URL records from the main screen
  - Back: Close the side menu bar

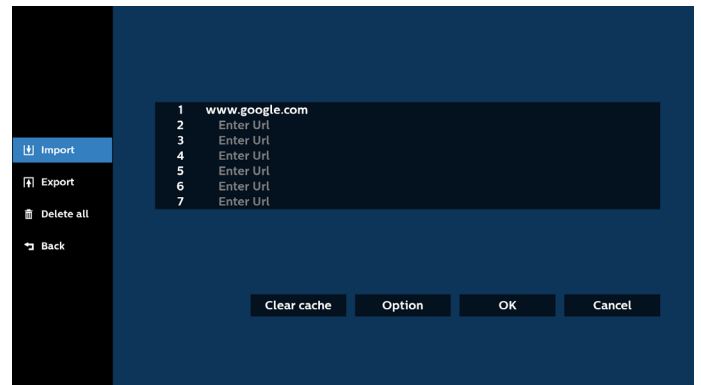

### 4.1 Import

- Select import.

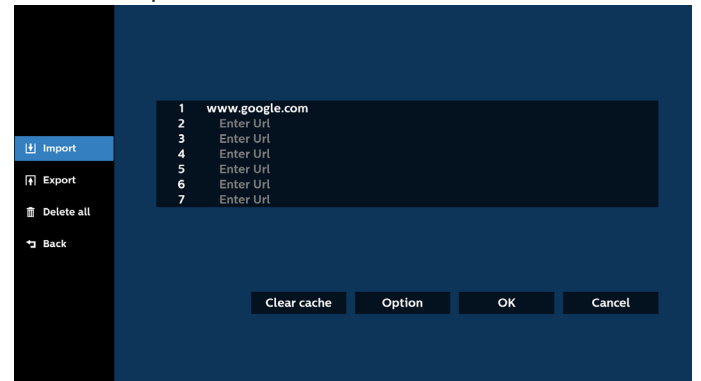

- Select the storage from which the file will be imported.

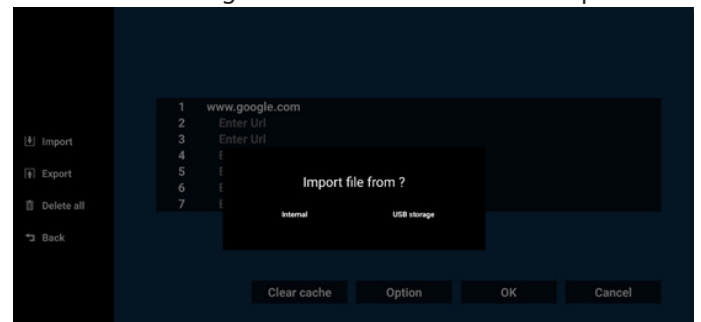

- Select a browser file.



- Import the browser file and the URL will be listed on the screen.

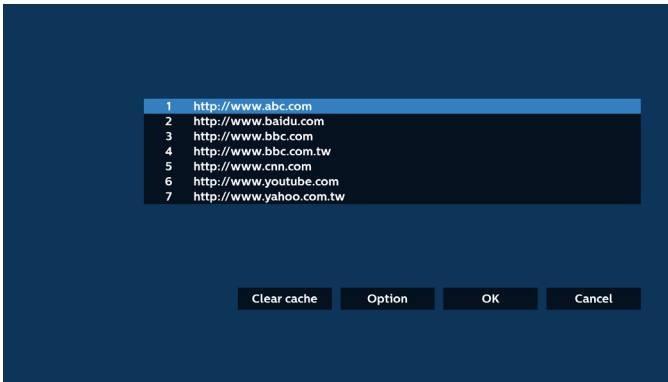

- The file format supported for import is “.txt”.

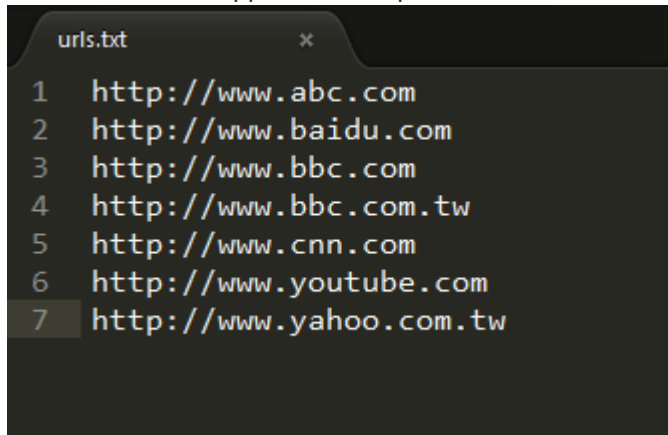

4.2 Export:

- Select export.

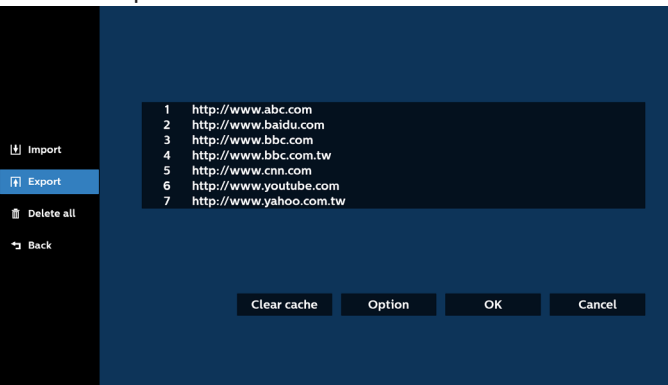

- Select the storage where the file will be exported to.

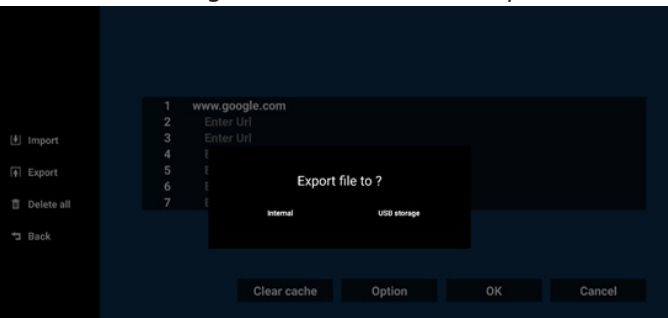

- A dialog box displays the path of the file to be saved as well as the file name. Press the “Save” button to save the URL.

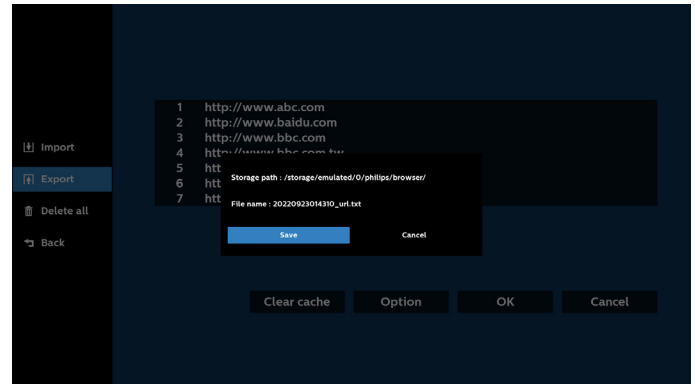

- 5. Press the “OK” button to save the URL record.

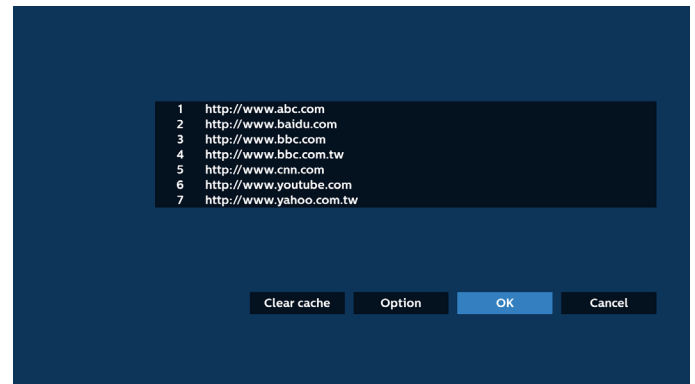

- 6. If you select a non-empty item from the URL list, a message will appear asking if you want to edit or play the URL. If you select “Edit”, a dialog box allows you to edit the URL. If you select “Play”, a web page of the selected URL appears.

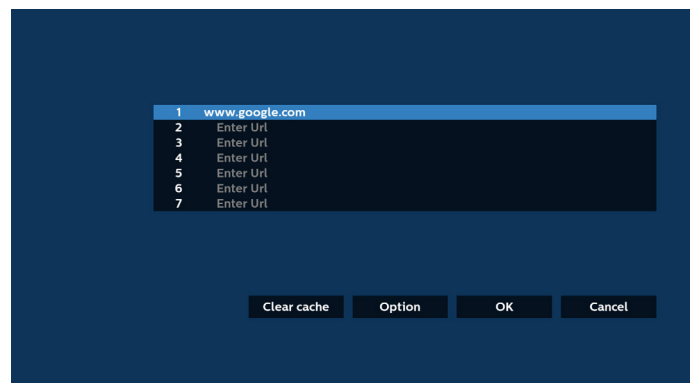

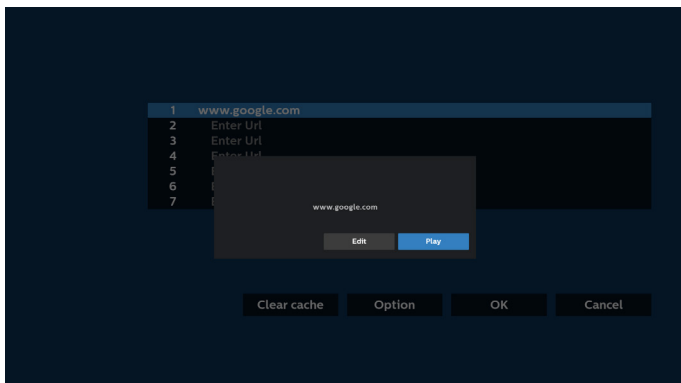

7. Press "Settings" then enter the next page.



### 7.1 Incognito

- Enable : Display webpages using incognito mode.
- Disable: Display webpages using non-incognito mode.



### 7.2 Reload

Allow users to set the webpage reload time.

- If the enable checkbox is unchecked, the default reload time is 60 seconds.

Note:

In this case, the webpage only reloads when the network state changes.

If the network state is always connected, the webpage will not reload after 60 seconds.

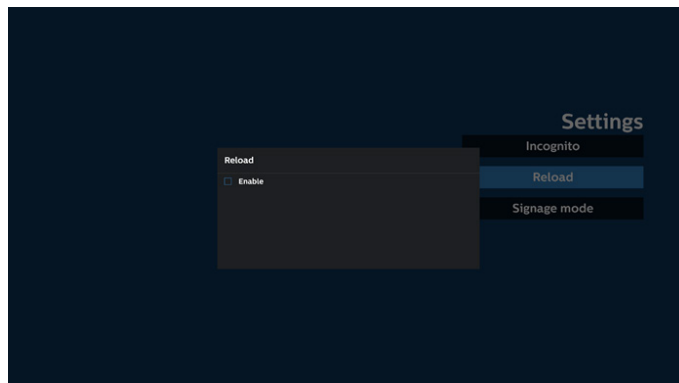

- If the enable checkbox is checked, you can set the reload time.

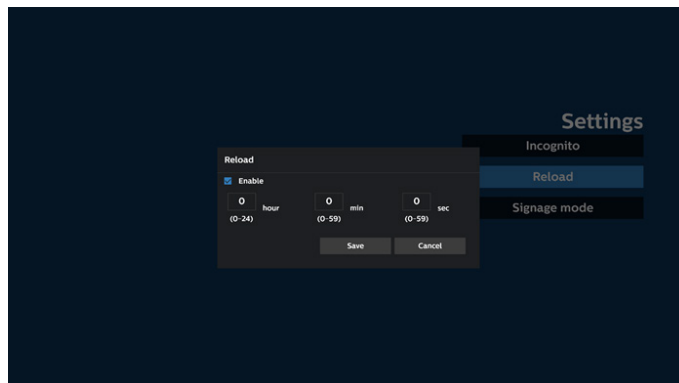

### 7.3 Signage mode

Enable going back to the Browser Compose page when the user returns from another app's activity. Disable keeping the Browser screen on the latest webpage. The option is enabled by default.

Open www.google.com and search for "PDF demo file". Click one PDF file in search result, the PDF file will be downloaded and opened. When user press "Back" button, the screen goes back to Browser Compose page if the option is enabled. The screen goes back to the search result if disabled.

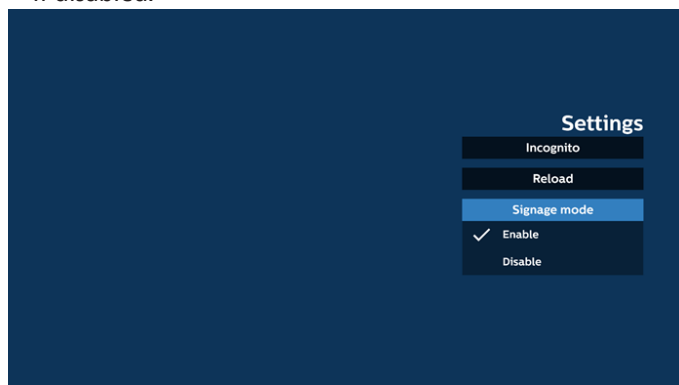

## 8. OSD menu interaction with Browser

## 8.1 Boot on source

Set OSD menu > Configuration1 > Boot on source > set BROWSER Play List to 0.

Then PD will show Browser after rebooting.

Set OSD menu > Configuration1 > Boot on source > Input be BROWSER Play List be 1.

Then PD will show the web page with 1st URL in Browser app.

## 8.2 Schedule

Set OSD menu > Advanced option > Schedule >

On time1, Off time2, Browser as input, any day of the week and Play List.

Then PD will show the web page with URL in Browser app at time1 and finish at time2.

## 9. How to edit the URL list via SFTP

Step 1. Create a text file of media player.

- File name: bookmarklist.txt.

- Content:



```
bookmarklist.txt
1 https://www.google.com.tw/
2 http://abc.go.com/
3
4
5
6
7
```

Step 2. Copy bookmarklist.txt to "philips" folder of your internal storage. You may use SFTP to do this.

- File path: /storage/emulated/legacy/philips (for DL, PL)

Ex. /storage/emulated/legacy/philips/bookmarklist.txt

Step 3. Start Browser App, it will import the text file of Browser automatically.

Note. Once the playlist file (text) is imported, any changes made through the remote control will not be recorded in the playlist text file.

## 10. Offline browsing

Offline browsing - Android 13

When URL 1 has set address, and use OSD schedule to open URL 1 web page, the browser app will automatically save URL 1 screenshot to local storage. The screenshot frequency is every 5 seconds and is only done 12 times.

If the network is disconnected while the OSD schedule is opening the browser app, the browser app will automatically open URL 1 screenshot from local storage.

Note:

- Browser app can only save URL 1 screenshot, URL 2 to URL 7 cannot be saved.
- Local storage: /sdcard/Download/Browser\_cache.png.
- The compose page will show a "Clear cache" button, pressing this button can clear URL 1 address home page data and screenshot in the local storage.

## 5.6. PDF Player

### 5.6.1. OSD menu interaction with pdf player:

1. Boot on source:
  - Input:
    - If you select pdf player source, platform will go to pdf player automatically after the boot complete.
  - Playlist:
    - Playlist 0 : go to home page of pdf player.
    - Playlist 1 - Playlist 7 : go to pdf player and playback File1 - File7 of playlist automatically.
2. Schedule:
  - Schedule list:
    - Set up to 7 schedules.
  - Enable:
    - Enable/disable schedule.
  - Start time:
    - Set start time.
  - End time:
    - Set end time.
  - Playlist:
    - 1 - 7 : go to pdf player and playback File1 - File7 of playlist automatically.
  - Days of the week:
    - Set Sunday, Monday, Tuesday, Wednesday, Thursday, Friday, Saturday.
  - Every week:
    - Set lifecycle.

### 5.6.2. PDF Player introduction:

1. The main page of PDF Player, this page consists of three options: "Play", "Compose" and "Settings".

Play: select a playlist to play.

Compose: edit the playlist.

Settings: set PDF Player properties.



2. Select "Play" on the main page. Then, you should select one playlist to play between FILE 1 and FILE 7."

The pencil icon means that the playlist contains the content.



3. Select "Compose" on the main page, first you should select one playlist to edit between FILE 1 and FILE 7.

The pencil icon means that the playlist contains the content.

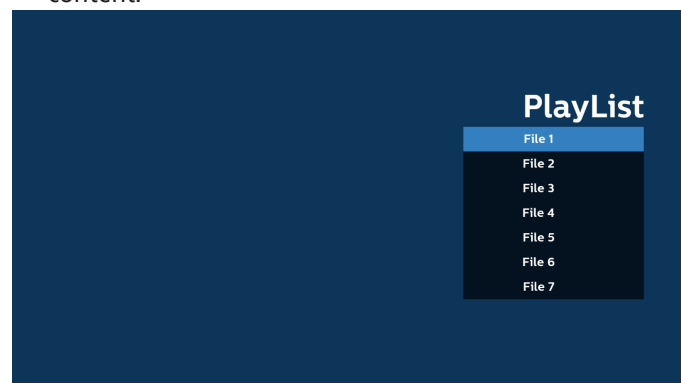

4. If an empty playlist is selected, the App will guide you through selecting the media source.

All media files should be stored in /philips/ of root directory. For example,

**pdfs : {root dir of storage}/philips/pdf/**

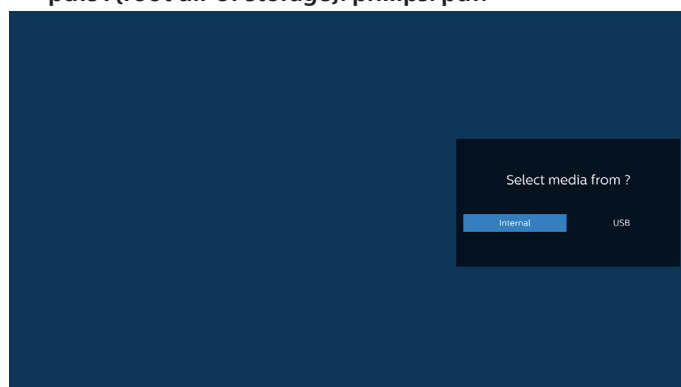

Note:

- If the USB stick cannot be found, the following message will be displayed. "Please plug in USB storage".

- Internal storage is always available, so it can navigate to the next page.



- To edit or delete a non-empty playlist, select the desired playlist that has a pencil icon on right side of the file.

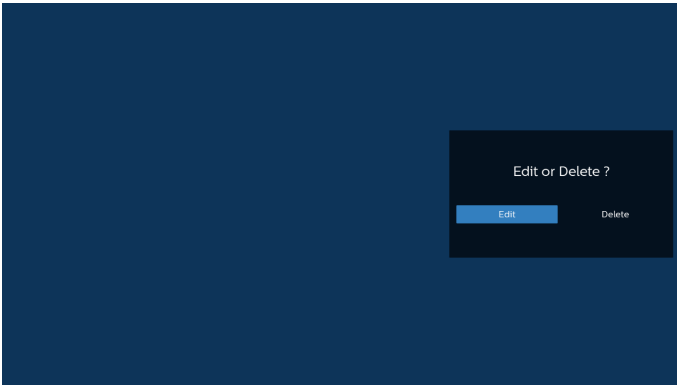

- Once you start to edit a playlist, a menu is displayed as below.

Source- files saved in the memory storage.

Playlist- files saved in the playlist.

The following functions can be operated through the corresponding keys on the remote control.

Option key – launch the side menu bar

Play key – play the media file.

Info key – show the media info.

Ok key – select/deselect a file.

- From the side menu bar, the following functions are available:

- Select all: select all files saved in the storage.
- Delete all: delete all playlist files.
- Add/Remove: add or remove a playlist from source.
- Sort: sort the playlist.
- Save/abort: save or abort the playlist.
- Back: return to the previous menu.

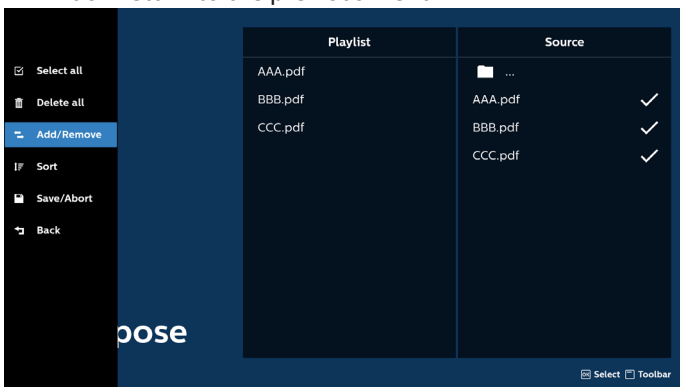

- If "Sort" is selected, you can customize the file order severally.



- Select "Settings" on the main page, there are three options available: "Repeat Mode", "Effect Duration" and "View Mode".

Repeat Mode: set the repeat mode.

Effect Duration: duration of photo effect.

View Mode : play with fit screen or play with original.

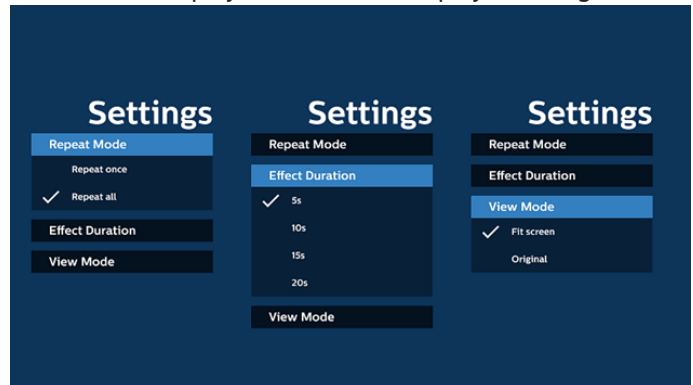

- How to edit the PDF list via SFTP:

Step 1. Create a text file of PDF player.

- File name: pdfplaylistX.txt, "X" means playlist number(1,2,3,4,5,6,7).  
Ex. pdfplaylist1.txt, pdfplaylist2.txt
- Content:

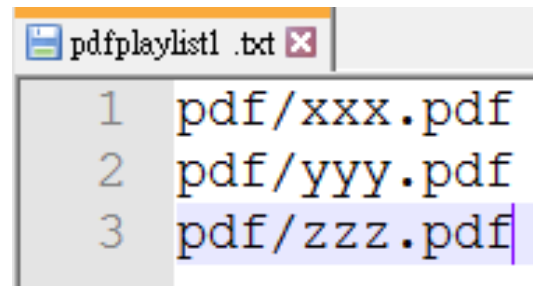

Step 2. Copy pdfplaylistX.txt to "philips" folder of the internal storage. You may use SFTP to do this.

- File path : /storage/emulated/legacy/philips (for DL, PL)  
Ex. /storage/emulated/legacy/philips/pdfplaylist1.txt

Step 3. Add the PDF files to the "PDF" folder in the "philips" folder of your internal storage.

- Ex. /storage/emulated/legacy/philips/pdf/xxx.pdf  
/storage/emulated/legacy/philips/pdf/yyy.pdf  
/storage/emulated/legacy/philips/pdf/zzz.pdf

Step 4. Start the PDF player App, it will import the text file of PDF player automatically.

Note: Once the playlist file (text) is imported, any changes made through the remote control will not be recorded in the playlist text file.

### Media Hotkey:

Play: play the file.

Pause: pause.

Fast forward: skip to the next page. If the page is close to the end of file, it will go to the next file.

Rewind: skip back to the previous page. If the page is close to the beginning of file, it will go to the last file.

Stop: return to the first page of file.

### Arrow keys:

Up/Down/Left/Right: Adjust the page. (when the page is zoomed in/out)

Left: Previous page. (when the page is not zoomed in/out)

Right: Next page. (when the page is not zoomed in/out)

### Combination key:

Number key + OK key: select a specific page and press OK key to change the page.

- Press a number key.

- Press OK key, the page number will be shown at the bottom of the page. If the page number exceeds the total page number, the current page number will remain at the bottom of the page.

### Note:

If you plug in two or more USB disks to edit the playlist, playback from the playlist cannot be guaranteed after powering on/off, due to the USB storage path may be changed. It is strongly recommended to use only one USB disk when editing the playlist.

## 5.7. Kiosk

Before using this feature, ensure that the system is connected successfully to the network.

1. Main page of "Kiosk" App which allows you to make related settings.

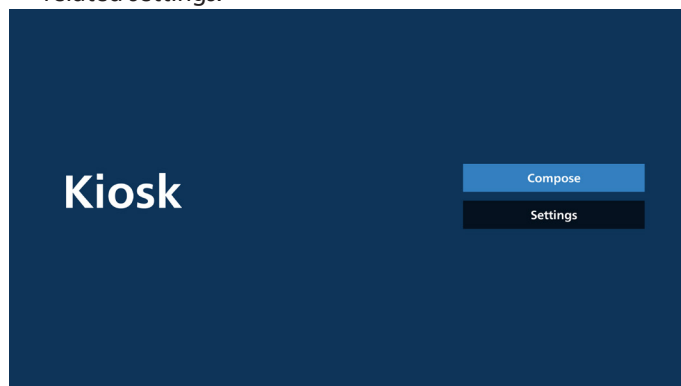

2. Press "Compose" then enter the next page. Choose from the list to edit the URL. There is only one URL for Kiosk. A dialog box appears after the selection is made.

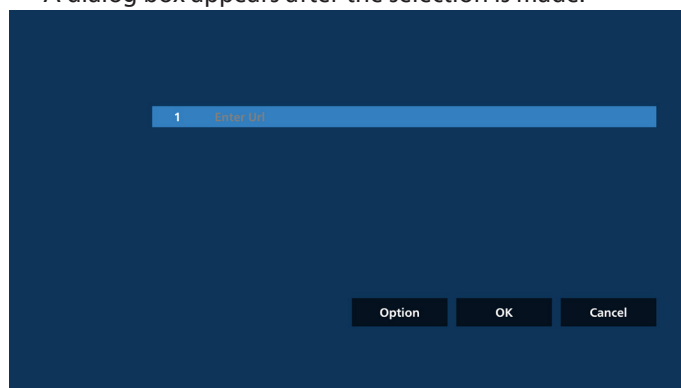

3. Use the on-screen keyboard to enter URL and press the OK button, the data will be saved in the List.

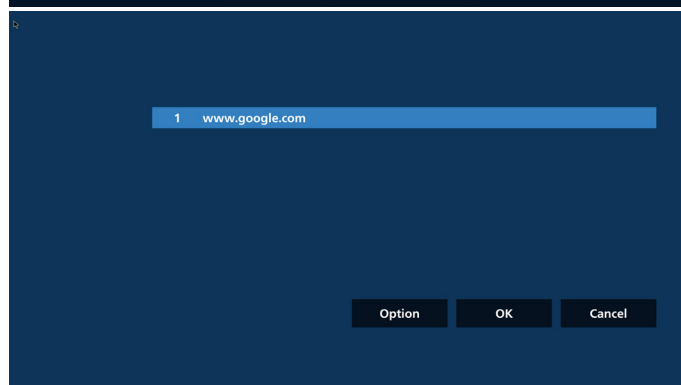
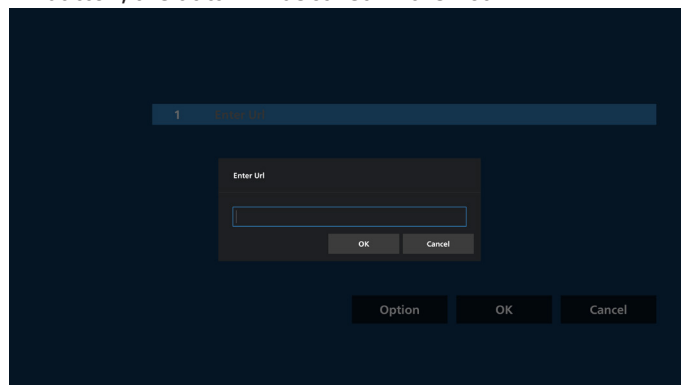

4. Press OK then URL records will be saved and go back to home page.

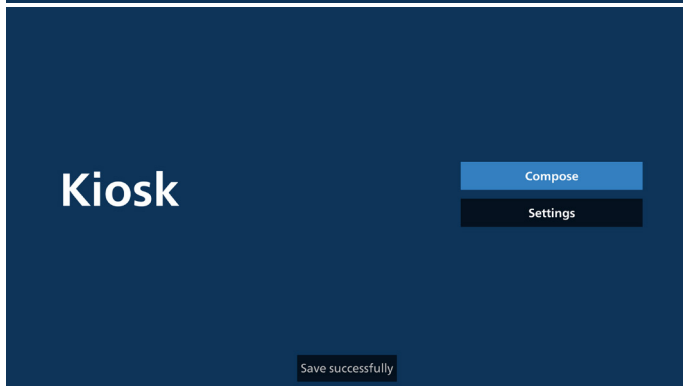
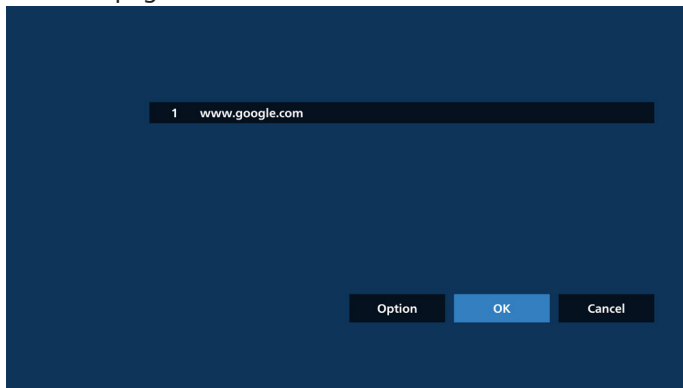

5. In the URL list page, if you select a non-empty item, a dialog will appear asking whether you would like to edit or play the URL. If you press "Edit," a URL edit dialog will appear. If you press "Play," the web page of the item's URL will be displayed.

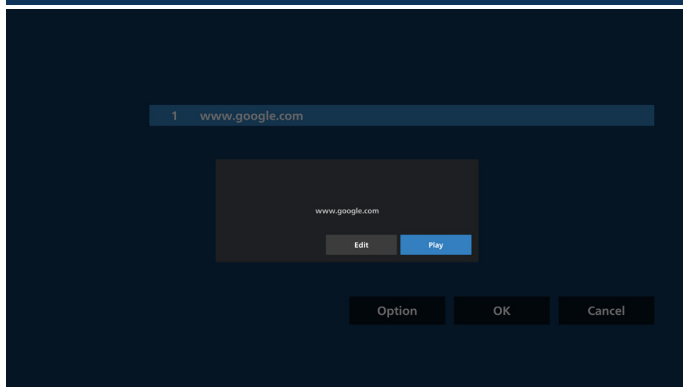
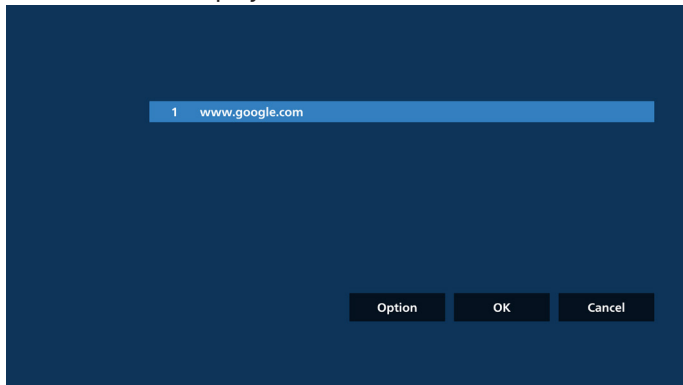

6. Compose Options

Press "Option" and a list will appear on the left.

Import: Import URL list file

Export: Export URL list file

Delete all: Delete all records of URLs in the URL list page.

Back: Close the list from the left side.

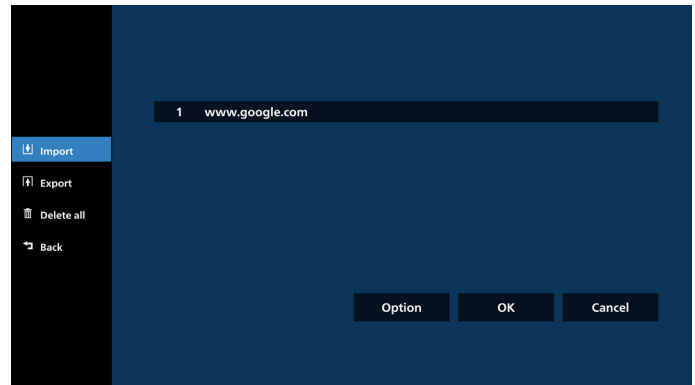

6-1. Import

a. Click import

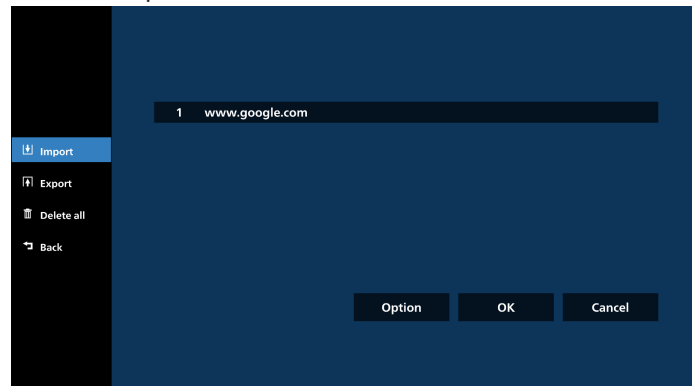

b. Choose storage

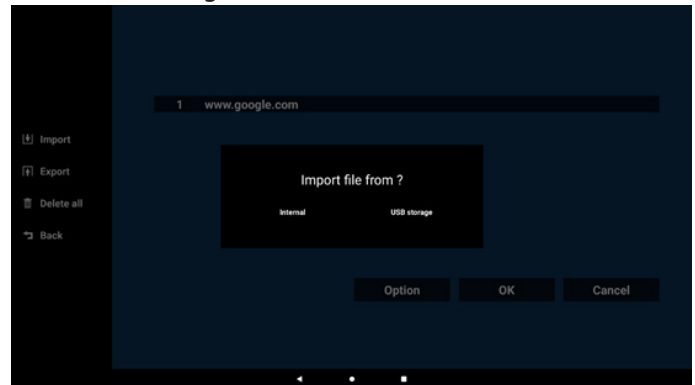

c. Choose a file that contains URLs.

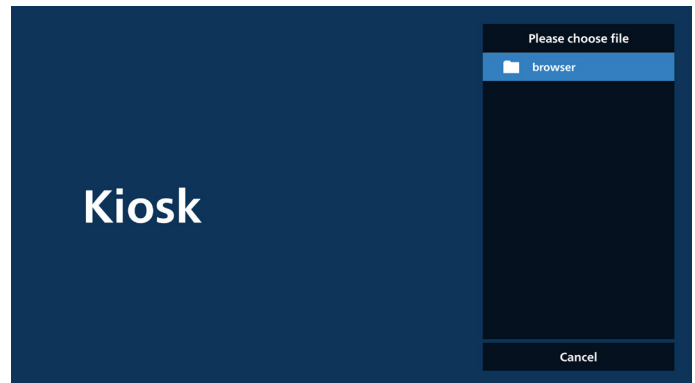

d. Import a file and the URL will be displayed on the list.

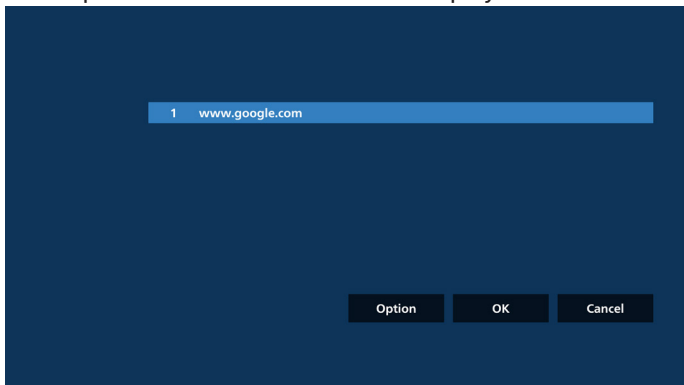

e. File format for import  
The file format should look like the example below, with the file extension "txt".

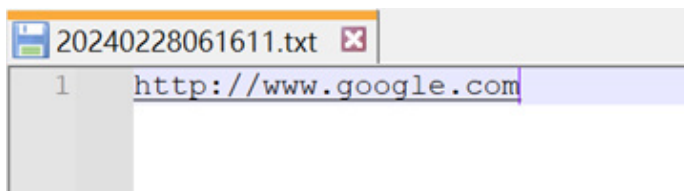

6-2. Export

a. Click export

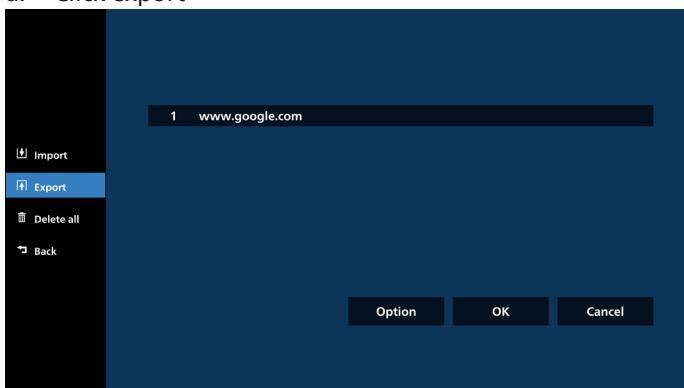

b. Choose storage

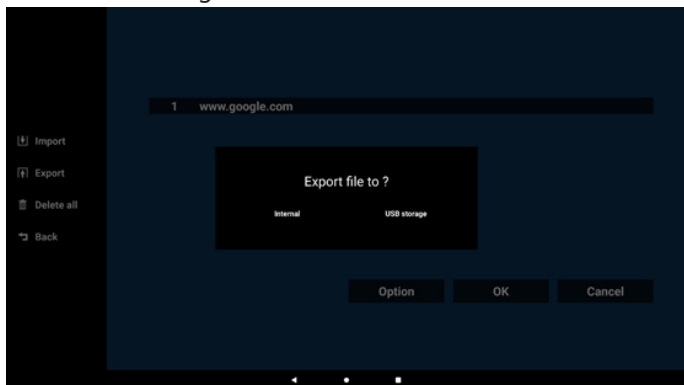

c. The file name and path to be saved will be displayed. Press the "Save" button to save the URLs to the file.

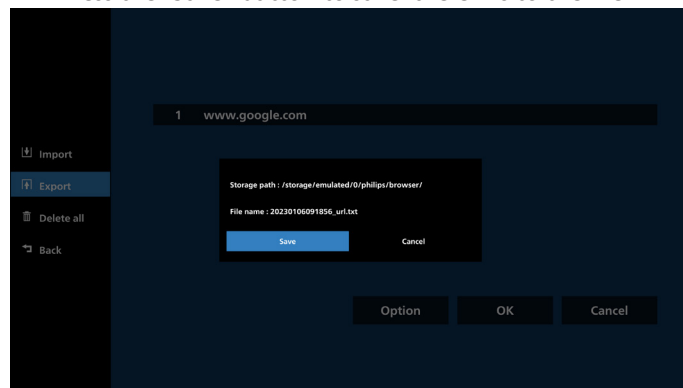

C-1. Press OK then Url records will be saved

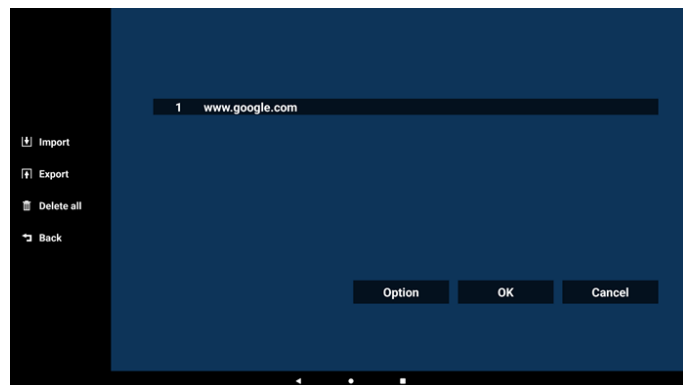

C-2. On Url list page, if you select non-empty item, it will show a dialog to ask edit or play url.

If press "Edit", it will show edit url dialog, if press "Play", it will show web page of item's url.

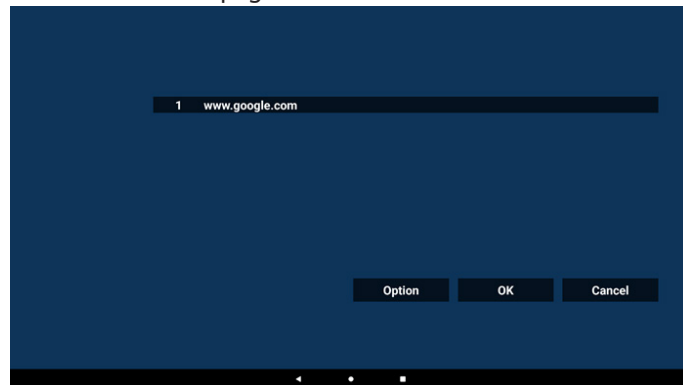

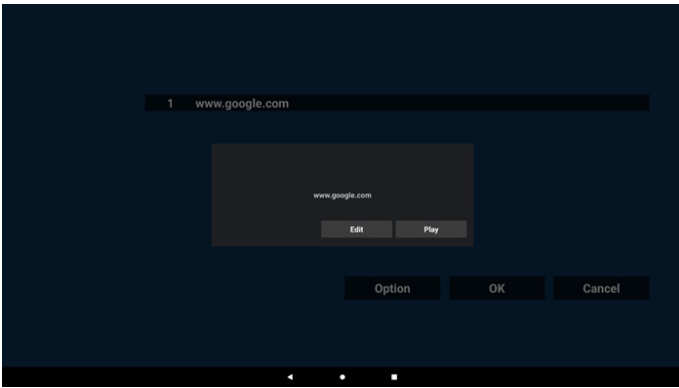

7. Settings

Press "Settings" to enter the settings page.



7-1. Incognito

Select "Enable" to display webpages using incognito mode. Select "Disable" to display webpages using non-incognito mode.

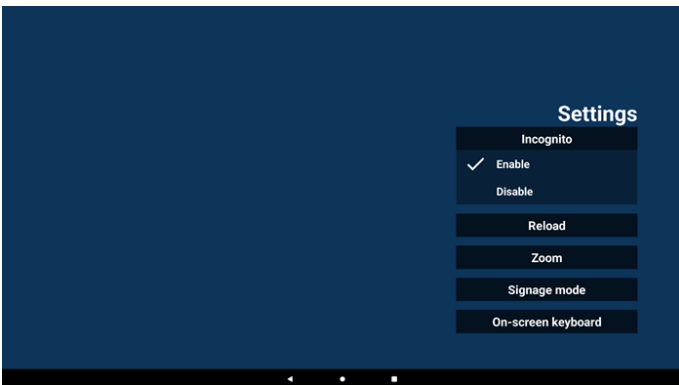

7-2. Reload

Allow users to set the webpage auto reload time. Reload time will reset and the countdown will restart if the user touches the screen.

a. If the enable check box is unchecked, disable auto reload.

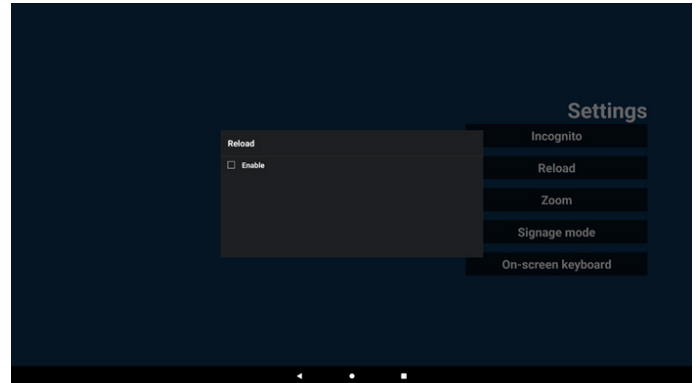

b. If the enable check box is checked, user can set up the auto reload time.

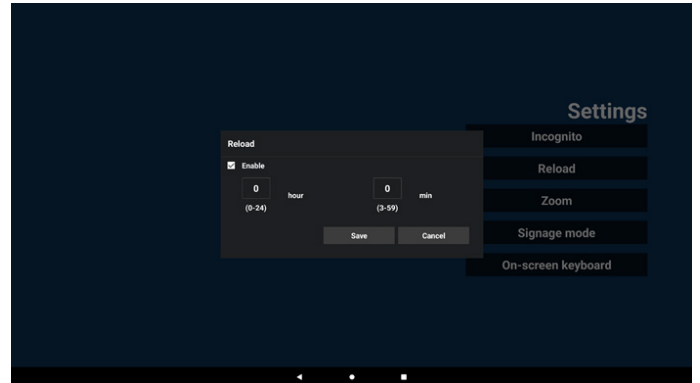

7-3. Zoom

Allow user to zoom in or out of a web page using two fingers. The webpage must support this option. This option is enabled by default.

For example:

Zoom in and out on [www.google.com](http://www.google.com) home page.

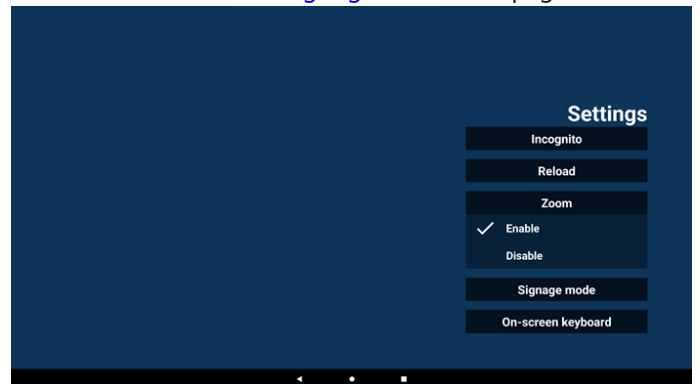

#### 7-4. Signage mode

Return to Kiosk home page while user is back from other APK's activity. With this option disabled, the kiosk screen will keep on the latest webpage. The webpage must support this option which is enabled by default.

For example:

Open [www.google.com](http://www.google.com) and search for "PDF demo file". Click one PDF file in the search results and the browser will download the PDF file and open the PDF APK to display the PDF content. When the user presses the "Back" button in the navigation bar, the kiosk will display the homepage if this option is enabled. Additionally, if this option is disabled, the kiosk will display the search results page.

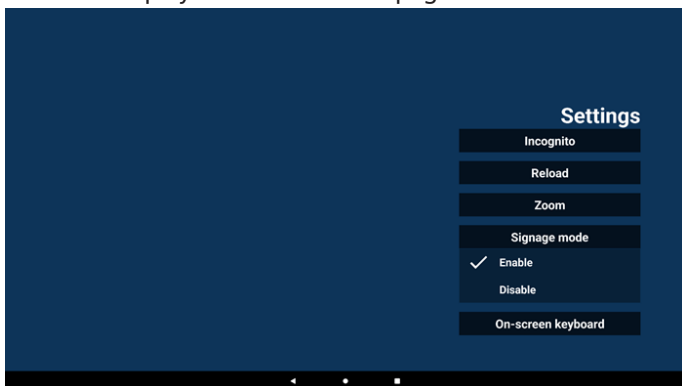

#### 7-5. On-screen keyboard

This option uses to enable/disable the display of the Input Method Editor (IME) on the webpage. If the user disables this option, the IME will not appear when clicking on the input text area.

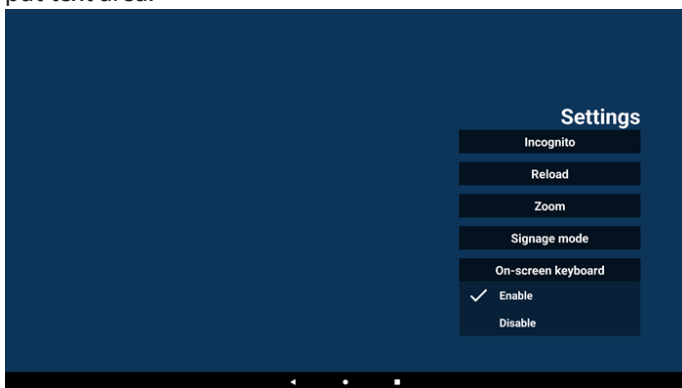

### 8. OSD menu interaction with Kiosk

#### 1. Boot on source

Set OSD menu => Configuration1 => Boot on source => Input is Kiosk

Play List is 0 (cannot be changed)

It will show the web page with URL in Kiosk app at time1 and finish at time2.

#### 2. Schedule

Set OSD menu => Advanced option => Schedule =>

On time1, Off time2, Input is Kiosk, any day of the week, and Play List.

Finally check the right box.

Then PD will show web page with URL in Kiosk app at time1 and finish at time2.

Note:

- The Kiosk App can only save data from the URL 1 address home page.
- To edit URL 1, user needs to open it from all apps or Settings -> Signage Display -> Source settings -> Android Source -> Kiosk.
- If starting the Kiosk from the source menu, the kiosk will open the URL automatically.
- If URL 1 has not been edited, the kiosk shows a home page when starting it from the source menu.

## 5.8. Custom App

User can set up the application for Customer Source.

### 5.8.1. OSD Menu operation:

RCU: Source -> Custom

If a custom APK is set, the PD will open the customer App when switching the source to Customer mode.

If custom source APK is not set, the system will show Home screen when switching to the custom input source.

### 5.8.2. Configure custom source

Settings -> Signage Display -> Source settings -> Custom app

User can set up custom source APK. The selected APK will be launched when switching to the custom input source. If custom source APK is not set, the system will show Home screen when switching to the custom input source.



If user set up APK for custom app source, it will show APK name. If not, means that user does not set up custom app.

#### Select app

Select specific APP for custom APP source.

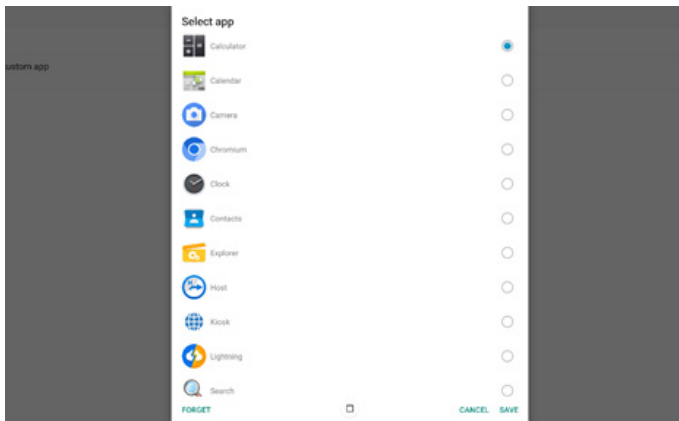

Note: Most system pre-installed APKs will not show in list.  
Only list the APKs that user manually installed and removable APKs.

Buttons:

(1). FORGET

Clear custom source application. Gray if user does not set customer source application.

(2). CANCEL

Do nothing and close dialog.

(3). SAVE

Click SAVE to choose selected APK as custom source application. Gray if there is no available application can be selected.

### Force Restart Custom APP

System can monitor custom APP exist or crash when enable "force restart custom APP". If custom APP leaved, and boot on source is set to "Custom app", system will try to lunch custom APP again.

Default is disabled.

## 6. File Manager

Entry: On the Application page, click the file manager icon to enter the native file manager.

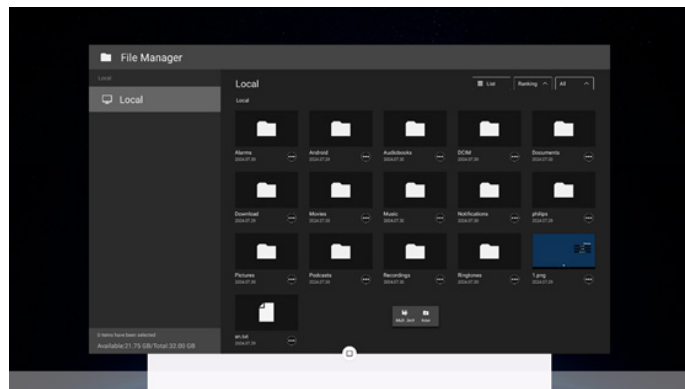

Files are displayed in thumbnail mode.

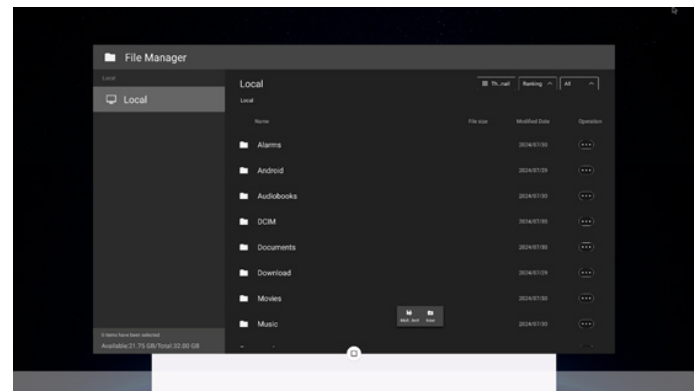

### 6.1. File Manager

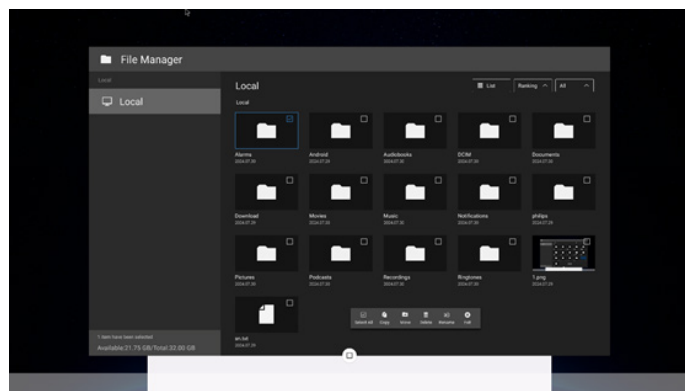

Select a file and rename, copy, paste, cut, or delete it.

### 6.2. Display Switch

Files are displayed in list mode.

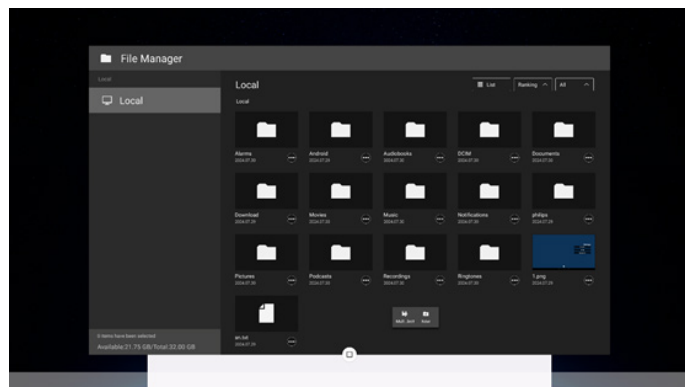



## 7. Setting UI

Enter PD settings by clicking “Settings” icon in Admin mode.

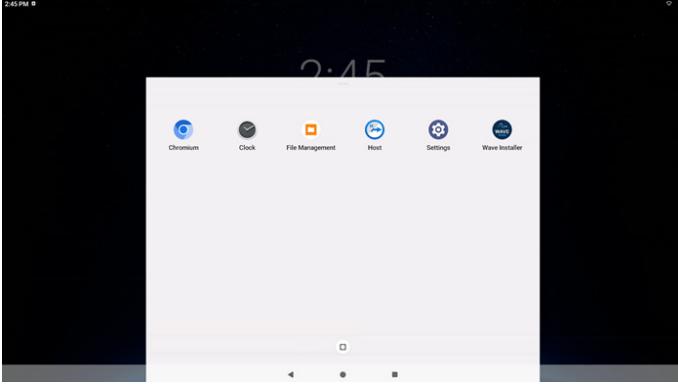

Setting menu consists of the following items:

- (1). Network & Internet
- (2). Connected Devices
- (3). Signage Display
- (4). Apps
- (5). Display
- (6). Accessibility
- (7). Security
- (8). System
- (9). About



### 7.1. Network & Internet

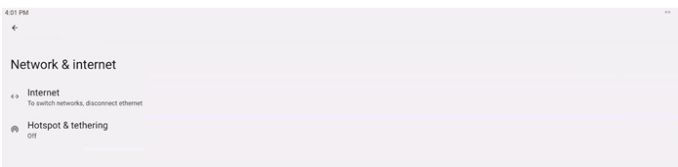

#### 7.1.1. Internet

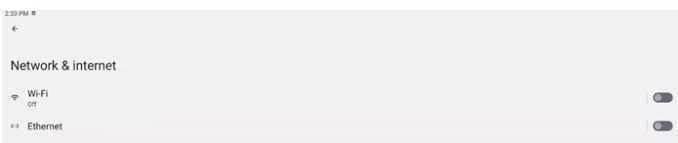

##### 7.1.1.1. Wi-Fi

Settings -> Network & Internet -> Wi-Fi

**Important Note:** This option is available only when the supported Wi-Fi dongle is plugged. Reboot the device whenever you plug or remove the USB Wi-Fi dongle.

#### Enable Wi-Fi

Enable/disable Wi-Fi connection through main switch in Setting -> Network & Internet -> Internet -> Wi-Fi -> Off/On toggle button.

#### Wi-Fi Off

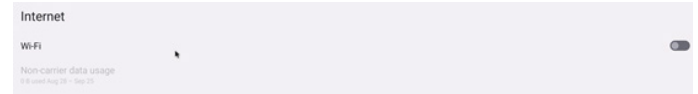

#### Wi-Fi On



On the available network list, select an AP (access point) on an existing wireless network.

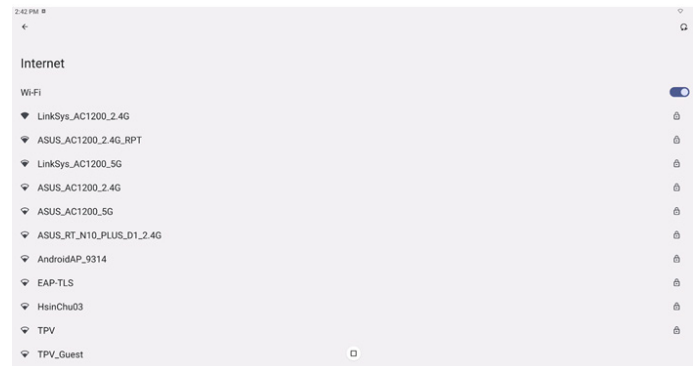

Click the AP name to connect it, a system dialog will pop up if password is need for this network.



There is an “Add network” item at the end of list. If network is not listed, use “Add Network” to join a hidden network.

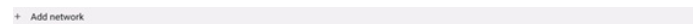

You must input network SSID, security type and other advanced options for this network.

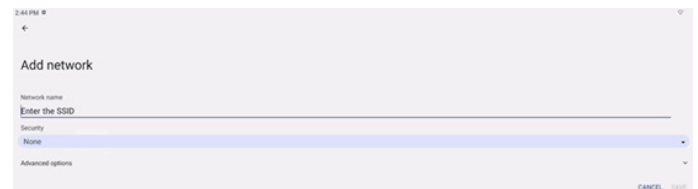

**Note:**

When Wi-Fi is enabled, Ethernet will be disabled automatically.

### 7.1.1.2. Ethernet

Settings -> Network & Internet -> Internet -> Ethernet

#### Enable Ethernet

Enable/disable Ethernet connection by Setting -> Network & Internet -> Internet-> Ethernet toggle button.



By default, the system uses DHCP to join the network. Connection Information (When the options are grayed out, they are not editable).

- A. IP Address
- B. Gateway
- C. Netmask
- D. DNS 1
- E. DNS 2
- F. Ethernet Mac Address



#### Note:

Wi-Fi connection will be disabled automatically when Ethernet connection is enabled.

#### Ethernet Static IP

When the Connection Type is changed to "Static IP", the user can manually set the Ethernet IP Address, Gateway, Netmask and DNS 1/2 address.

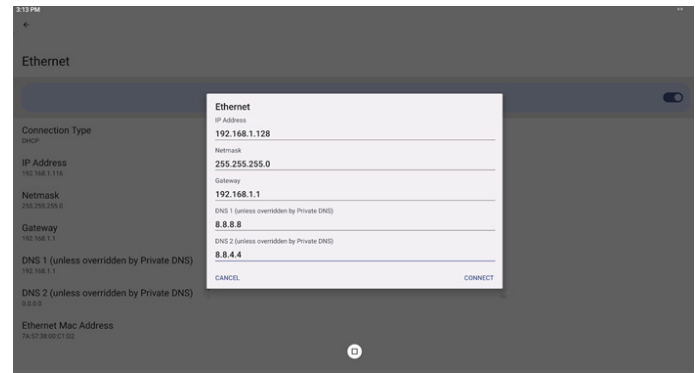
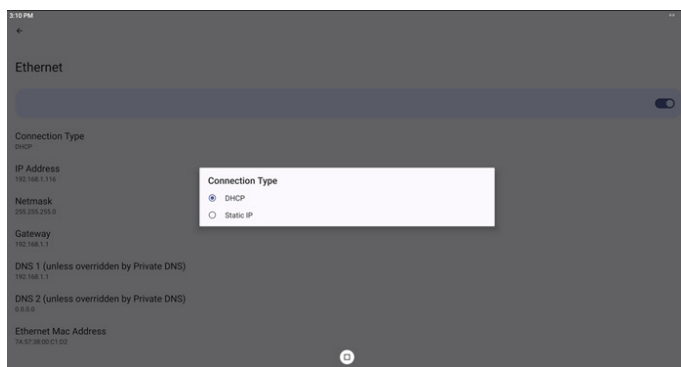

#### Note:

1. Please input IPv4 address in all fields; in dot-decimal notation, consisting of four decimal numbers, each ranges from 0 to 255, separated by dot.

### 7.1.2. Hotspot & tethering

Settings -> Network & internet -> Hotspot & tethering

Important Note: This option only appears when the supported Wi-Fi dongle is plugged-in.

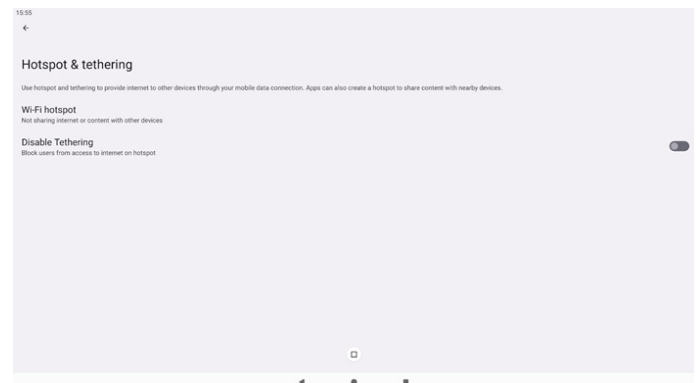

#### 7.1.2.1. Wi-Fi Hotspot

Settings -> Network & internet -> Hotspot & tethering -> Wi-Fi hotspot



#### Use Wi-Fi hotspot

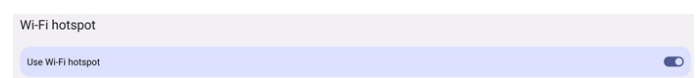

When enable this, the Wi-Fi turn off connection and become a hotspot AP (access point). Other Wi-Fi client devices can join into and share network. User can set up detail Wi-Fi hotspot information when user enable "Wi-Fi hotspot".

## Setup Wi-Fi hotspot information

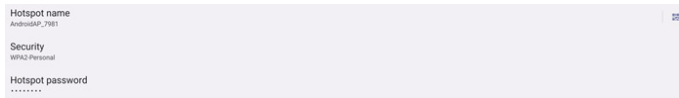

**Hotspot name :** It is the SSID and must comply with the IEEE 802.11 specification. It is recommended to use 0-32 octets with UTF-8 encoding.

**Security :** System provide NONE and WPA2 PSK security protocol to provide hotspot network. Suggest using WPA2 PSK which more secure than NONE.

**Hotspot password :** It is randomly generated for other clients to connect by default. The user can also set a new password manually.

## Turn off hotspot automatically

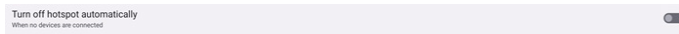

When enabled, this feature will automatically deactivate the hotspot if no devices are connected to it for a specified period of time. This prevents the hotspot from staying on unnecessarily when it's not in use.

## Disable Tethering

By default, devices can use mobile data to access network via a hotspot. If enabling the option, the system will block devices from network access by hotspot.

## 7.2. Connected Devices

Show the devices connected via Bluetooth.

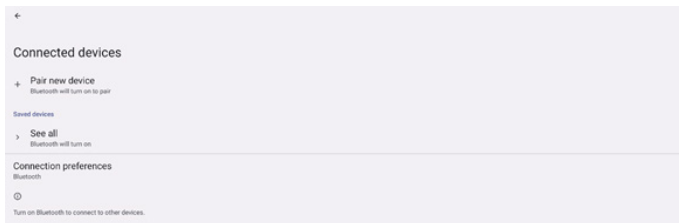

## 7.3. Signage Display

Settings -> Signage Display, to setup most features of signage display. Descript in below sessions.



### 7.3.1. General Settings

Settings -> Signage Display -> General Settings

Set up Signage Display name, User logo and Screenshot, Floating menu and Gestures.



### Signage Display Name

Settings -> Signage Display -> General Settings -> Signage Display Name

Set up PD name, default name Ethernet MAC address with prefix "PD\_". For example, "PD\_000b12223398". The max length of name is 36 chars in UTF8 format. Click to rename it.



### Boot Logo

Set up personal boot animation to show when system powers on. User can set up device boot up logo (boot animation) when OSD Menu -> Configuration 2 -> Logo is set to "User" mode

If the Logo is not set to "User" mode, the user will not be able to select a custom boot animation.

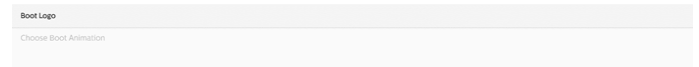

When set to "User" mode, the "Choose Boot Animation" becomes available.

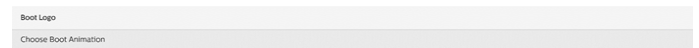

When Logo is set to User mode, the system will disable the default Philips logo and replace it with the user selected boot animation file. If user does not set a boot animation file for User mode, the default Philips boot animation will be displayed during boot time.

Click "Choose Boot Animation" to pop up a dialog for the user to select a boot animation file. The system will automatically scan the files under the USB storage.

The boot animation file name must be set to "bootanimation.zip", any other name is invalid.

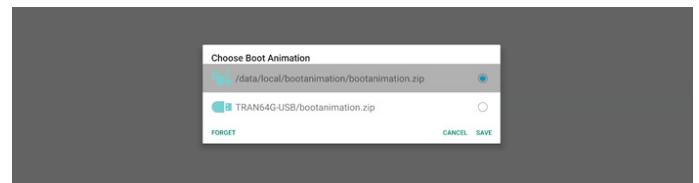

All available boot animation files can be found in the following folder:

1. File under /data/local/bootanimation/:  
The boot animation file that was copied from USB.
2. File under {USB\_STORAGE\_VOLUME\_NAME}/:  
The boot animation file saved on the USB storage.

## Dialog options:

1. **FORGET**  
Clear "bootanimation.zip" under /data/local/bootanimation/.  
Custom boot animation will not be used during system boot up.
2. **CANCEL**  
Cancel and close the dialog box.
3. **SAVE**  
Copy the selected file to /data/local/bootanimation/.  
After doing this, user can remove their external storage (USB). System uses the boot animation file under /data/local/bootanimation/.

If the system does not found any bootanimation.zip file under external storage (USB) and /data, the file list will be empty. The "SAVE" and "FORGET" buttons will be grayed out, user should check the content saved on the USB memory. Click "CANCEL" button to close the dialog box, and plug in the USB memory again.



If /data/local/bootanimation/ folder is empty, it means that "bootanimation.zip" has not been saved by the user before. Default Philips logo appears during system boot up.

When "bootanimation.zip" is found in the external storage, a dialog box displaying the list of files will appear.

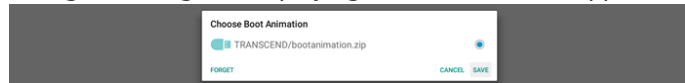

If the file "bootanimation.zip" can be found in the folder "/data/local/bootanimation/", the pop-up dialog box will show that file as the first option. It simply means that user has previously copied (saved) the file "bootanimation.zip" and that the system will boot up with boot animation from /data/local/bootanimation/bootanimation.zip.

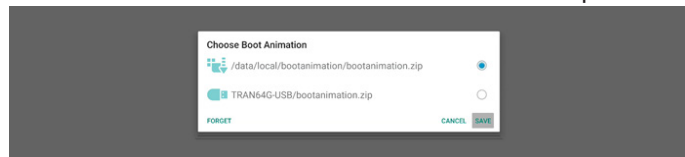

Boot animation file can be replaced by using the "SAVE" button.

## Screenshot

Settings -> Signage Display -> General Settings -> Screenshot  
To capture the screenshots from the imported content, click "Enable" to enable the auto screenshot function. If the screenshot options are grayed out, it means that the screenshot function has not been enabled yet.



After enabling this feature, you can set the interval time between each screenshot, as well as the destination folder where the captured screen will be saved. The option "Save to" notifies you that the screenshot images will be saved to the internal storage and they cannot be changed manually.

### NOTE:

1. The screenshot images will be deleted automatically under the following conditions:
  - (a). When the start time of the screenshot feature is set to 0 seconds.
  - (b). Starting the screenshot at 40 seconds of minute.
  - (c). If you decide to purge the screenshot photos every week, the data of deleting the photos will be changed to the day that you apply the setting of screenshot feature. For example, if you set the purging day to Monday of every week, then changed other settings in screenshot feature on Friday, the purging day will be changed to Friday (the day of the system's current time).
2. Sleep (system suspend) and screenshot feature:  
The screenshot feature is suspended when the system enters sleep mode. The function of mailing out the screenshot is consequently suspended. The screenshot-related features will be restarted when the system enters active mode.
  - (1) Interval  
Set the interval time between each screenshot. The available options are 30 and 60 minutes.



### .Start Time

Set the start time of a day to begin the screenshot function. Make sure that you click the "Save" button before leaving the dialog box, or your settings will not be saved. The start time must be lesser than the end time. A toast message will appear notifying you if it is an invalid value.



- (2). End Time  
Set the end time of a day to end the screenshot function.  
Make sure that you click the "Save" button before leaving the dialog box, or your settings will not be saved.  
The start time must be lesser than the end time. A toast message will appear notifying you if it is an invalid value.



- (3). Repeat  
Set the repeat mode for auto screenshot.

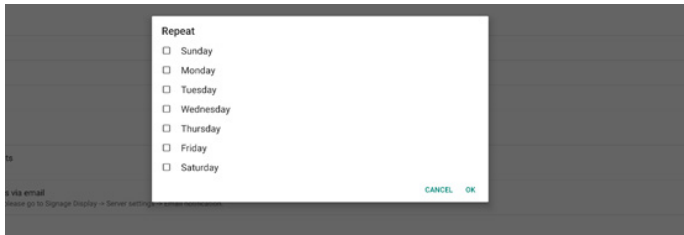

- (4). Save to  
The screen images will be saved in the folder "philips/screenshot" of the internal storage.
- (5). Purge Screenshots  
Set the interval time for deleting the screenshot images. The available options are "Every day" and "Every week".



- (6). Send screenshots via email  
You can send each screenshot image as an e-mail attachment. The user must first set up the mail information in "Settings -> Signage Display -> Server Settings -> Email notification" (Refer to [Email Notification](#) section).

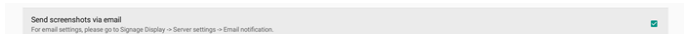

**Floating menu**

Custom the functions of floating menu during touch gesture. These options only available when platform has supported touch device.



Always on: If floating menu is Always on, floating menu will always be shown on the screen. In contrast, If floating menu is Always off, floating menu will be hidden on the screen.  
Always off: If floating menu is Always off, you can still use RCU/Keypad to bring the OSD menu/Source menu.  
Auto hide: The countdown is based on the number of seconds set by "Countdown timer". Floating menu will be automatically hidden after the countdown. Swipe up to show floating menu again.

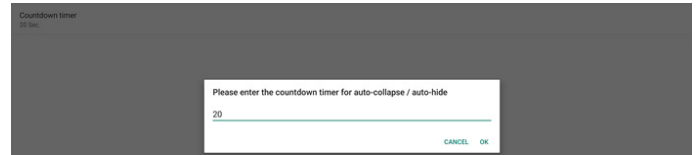
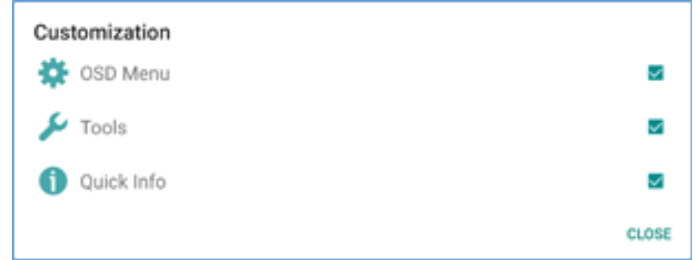

The Countdown timer is a number between 0 and 60.

**Gestures**

Enable or disable the gesture of swipe up and long press in Home.



All Apps: swipe up in Home

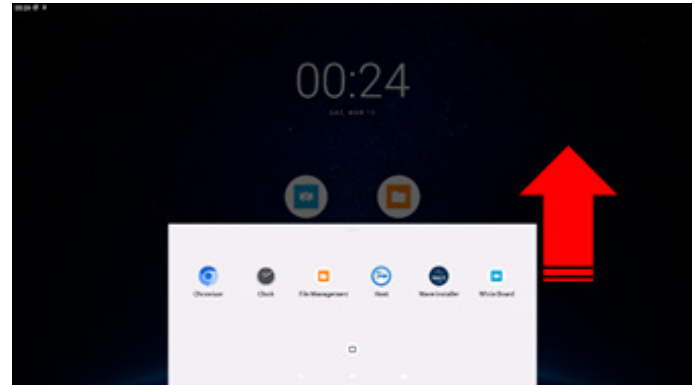

Widgets: long press in Home

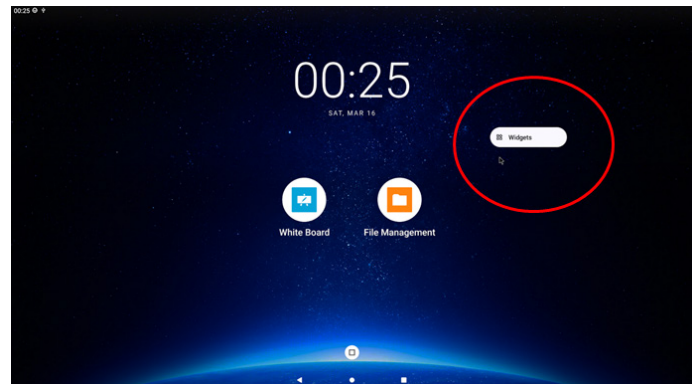

## 7.3.2. Server Settings

Settings -> Signage Display -> Server Settings

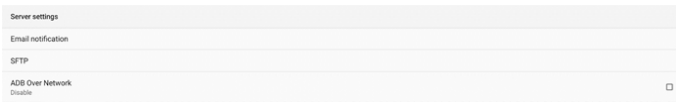

### Email Notification

Settings -> Signage Display -> Server Settings -> Email Notification

Click checkbox to enable/disable E-mail notification feature. Set SMTP and manager E-mail after enabling the E-mail notification feature.



### SMTP

Set up sender E-mail address and SMTP server information. There are two types of SMTP server for user to set up: "Gmail" and "Other". By using "Other" option, user can manually setup SMTP server, security type and server port.

Note:

1. The password should be in UTF8 format with 6 to 20 characters.
2. User cannot set port 5000 (SICP default port) and 2121 (SFTP server default port).  
SICP network port setting in "Settings -> Signage Display -> Network Application -> SICP network port".  
SFTP network port settings in "Settings -> Signage Display -> Server settings -> SFTP -> Port".

Gmail: (SMTP server, Security type and Port are grayed out)

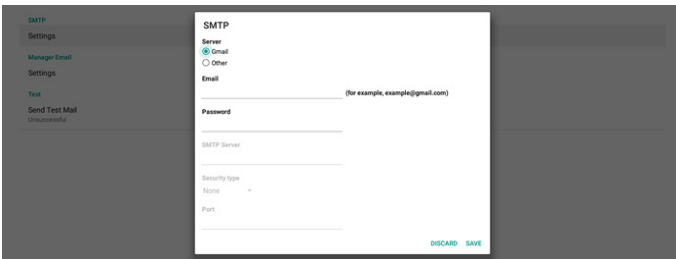

Other:

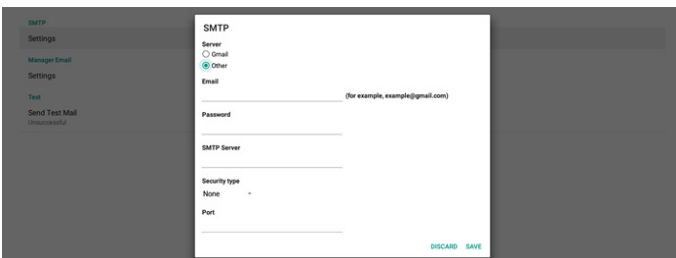

## Gmail Security Settings

If you are using Gmail but cannot sent out E-mail, please check Google Account Security Setting in website: <https://www.google.com/settings/security/lesssecureapps>. And turn on "Access for less secure apps".

Open a web browser and login into your Google account. Click on "Security" menu (it can be located on the left or at the top of the webpage).

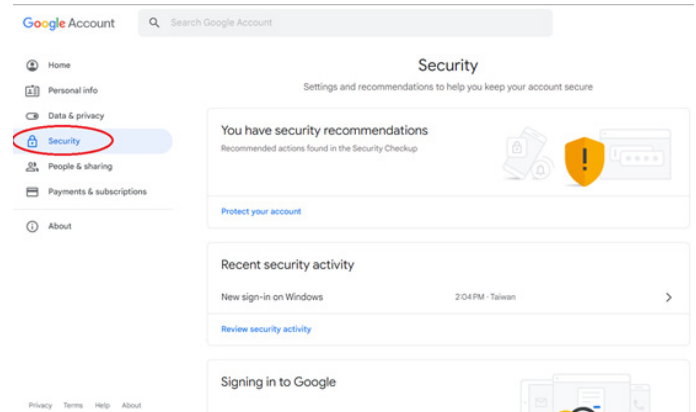

### Step 1 - Select "2-Step Verification"

If 2-Step Verification is not turned on, click it to enable it.

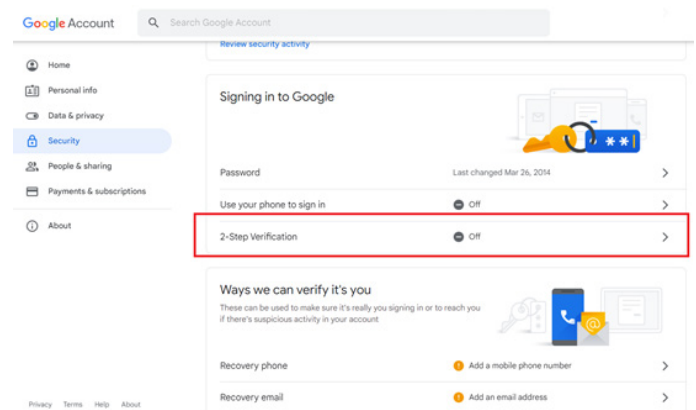

### Step 2 - Configure 2-Step verification

Click the "GET STARTED" button to start configuring the 2-step verification options.

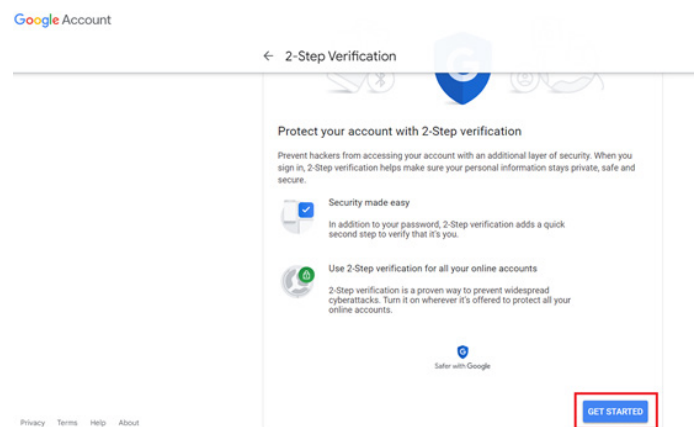

You may be prompted to log in to your Google Account again to confirm it's you:



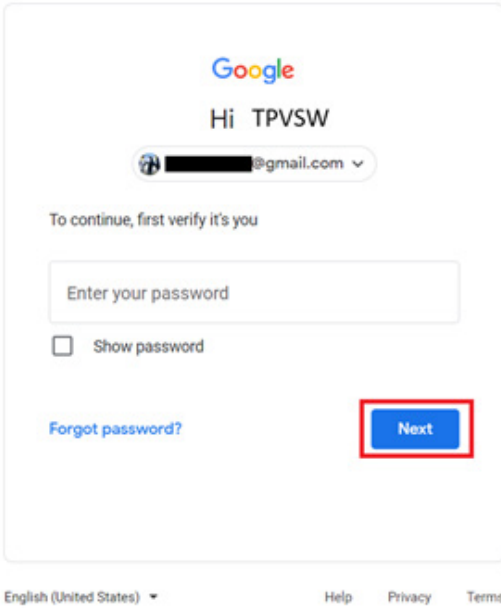

**Step 3 - Use your Phone to Complete Configuration**  
 Use on-screen instructions and available options to complete 2-Step verification using your phone.

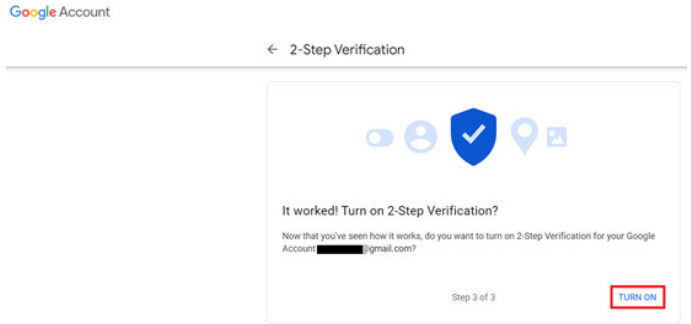
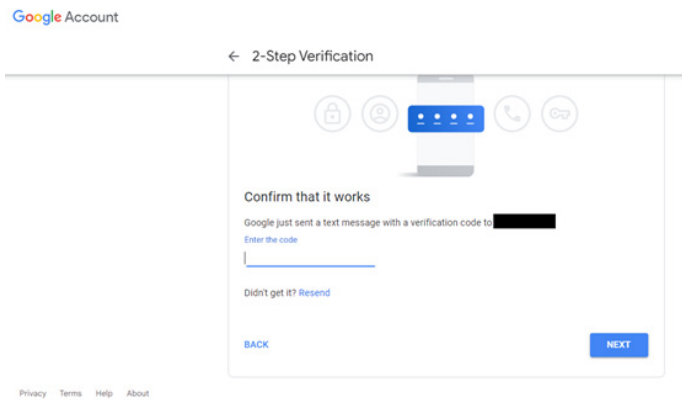
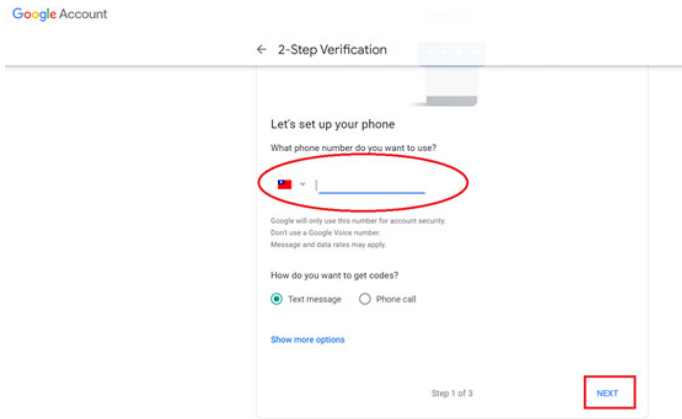

**Step 4 - Create the App Password**  
 Click on the "App Password" option to create a new application password:

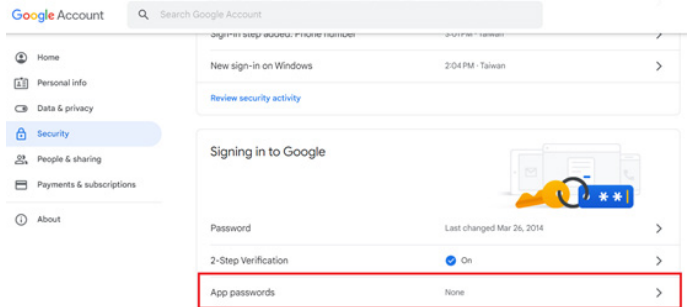

**Step 5 - Add New App Name**  
 First, select a device (for example, Windows Computer) and then click on "Select App" menu and choose "Other (custom name)":

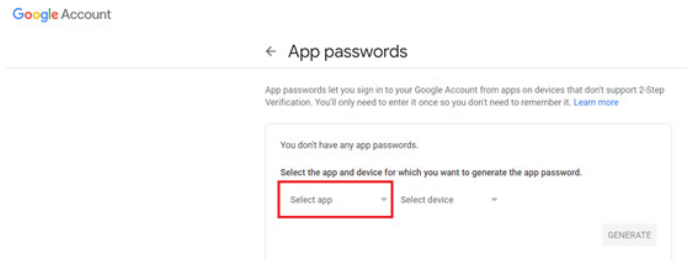

Enter a custom application name (it really does not matter what name is used in this field). Click "Generate" button:  
 (Ex. Enter "SignageDisplay" as an app name)

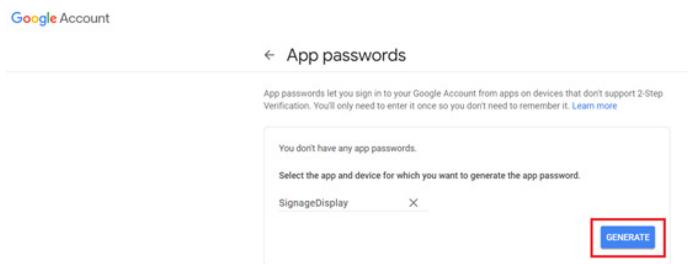

Record the auto-generated app password or simply select it and copy to the clipboard for the later use.

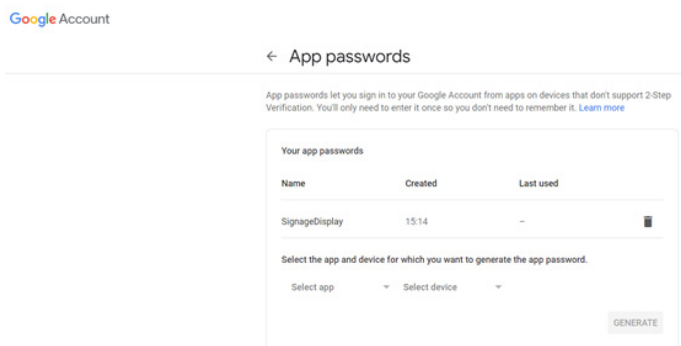
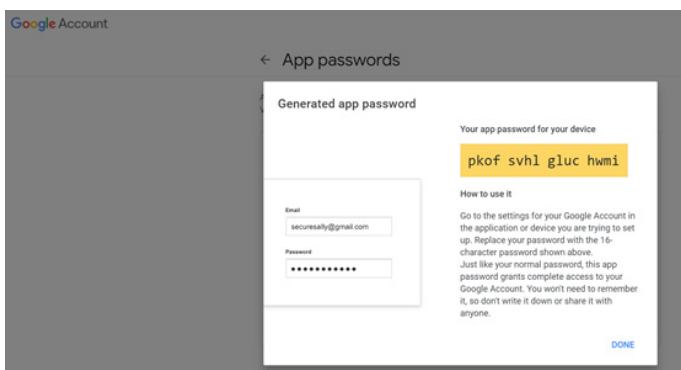

## Manager Email

Specify the destination address to receive the e-mail.



## Test

To check if your e-mail settings are correct, select 'Send Test Mail' to send a test e-mail.

## SFTP

Settings -> Signage Display -> Server Settings -> SFTP

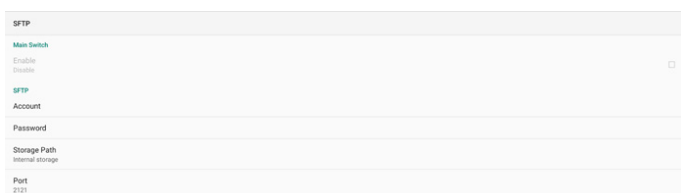

Click the checkbox to enable/disable SFTP server feature. After enabling this feature, user can setup account, password and port number.

- (1). **Account:** The user name to log into the SFTP server must be between 4 and 20 characters long, and only alphanumeric characters (a-z, A-Z, 0-9) can be used.
- (2). **Password:** The password to log into the SFTP server should be between 6 and 20 characters long, and can only contain the characters [a-z], [A-Z], and [0-9]. After setting the password, it will be displayed as asterisks.
- (3). **Storage path:** The SFTP server has access to the internal storage only. The storage path is unchangeable.
- (4). **Port:** The port number for the SFTP server is available in the range from 1025 to 65535, the default setting is 2121. The following port number cannot be used: 8000 / 9988 / 15220 / 28123 / 28124 and SICP network port (default 5000).

Finally, manually reboot the system to apply the SFTP settings.

## ADB over Network

You can access ADB over a network connection with default port 5555.

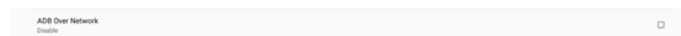

## 7.3.3. Source Setting

Settings -> Signage Display -> Source Settings

User can configure source APK's detail options.

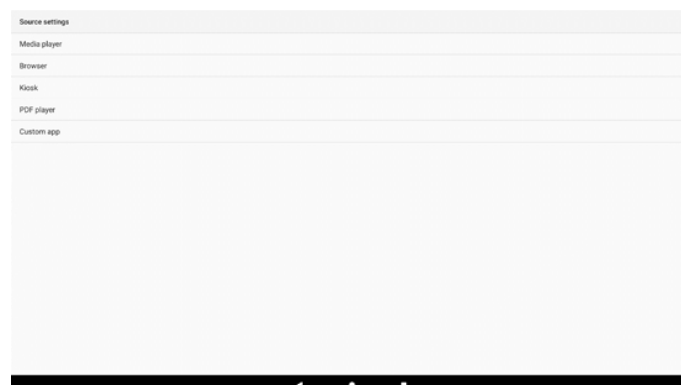

## Media Player

Settings -> Signage Display -> Source Settings -> Media Player

Open Media Player APK's edit play list activity and edit effect settings activity.

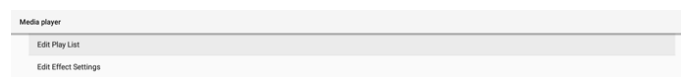



Edit play list opens MediaPlayer playlist compose page.



Edit effect settings opens MediaPlayer settings page.

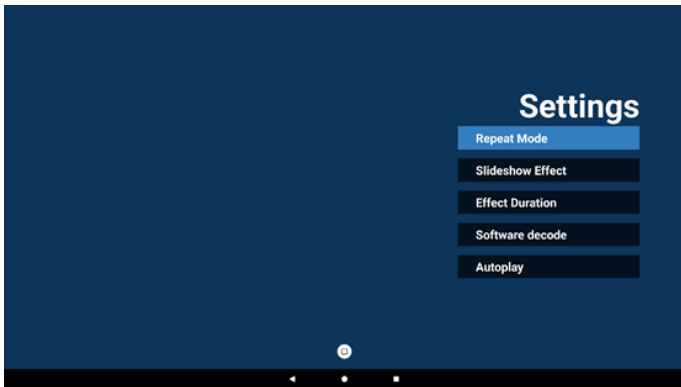

**Browser**

Settings -> Signage Display -> Source Settings -> Browser  
Open Browser APK's main activity.



**Kiosk**

Settings -> Signage Display -> Source Settings -> Kiosk  
Open Kiosk APK's main activity.

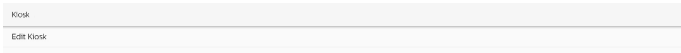

**PDF Player**

Settings -> Signage Display -> Source Settings -> PDF Player  
Open PDF Player APK's edit play list activity and edit effect settings activity.

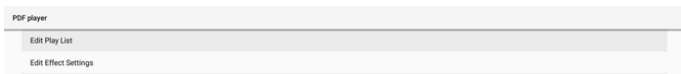

**Custom app**

Settings -> Signage Display -> Source settings -> Custom app  
User can set up custom source APK. The selected APK will be launched when switching to the custom input source. If custom source APK is not set, the system will show Home screen when switching to the custom input source.

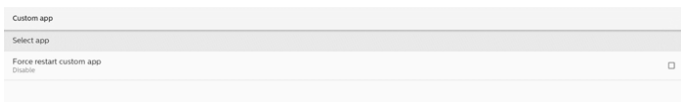

**Select App**

Select a specific APP for custom APP source.

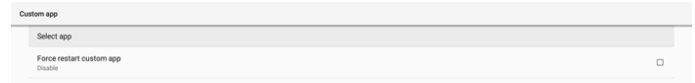

If user set up APK for custom app source, it will show APK name. If not, it means that custom App is not configured.

Select a specific APP for custom APP source.

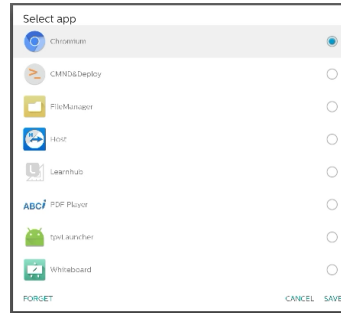

Note:

Most pre-installed APKs will not be shown on the list. It only lists the APKs installed manually by user or removable APKs.

Buttons:

- (1). FORGET  
Clear custom source application. It turns gray if custom source application is not set.
- (2). CANCEL  
Cancel and close the dialog.
- (3). SAVE  
Click SAVE to choose the selected APK as custom source application.

**Force Restart Custom APP**

The system can monitor whether custom APP is present or crashing when "Force Restart Custom App" is enabled. If the custom App is not present and boot on source is set to "Custom App", the system will launch custom App again.

Default is disabled.

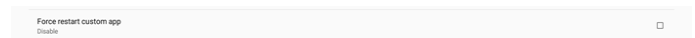

**7.3.4. Network Application**

Settings -> Signage Display -> Network Application

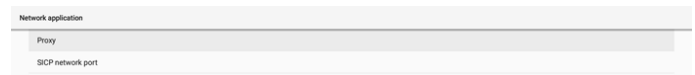

## Proxy

Settings -> Signage Display -> Network Application -> Proxy  
 Enable/disable network proxy by tapping "Enable" checkbox.  
 User can set up host IP and port number of the proxy server.  
 Default is disabled.



System supports the following proxy types: HTTP/HTTPS, SOCKS4, and SOCKS5. Choose one for your proxy server.



If authorization with login name and password is required for proxy server, enable the checkbox for these items.



## SICP Network Port

Settings -> Signage Display -> Network Application -> SICP Network Port

Set up SICP default port and enable/disable network SICP.  
 Default SICP is enabled with port 5000.

Note:

Port number ranges from 1025 ~ 65535.

The following ports are occupied, they cannot be assigned to SICP network port: 8000, 9988, 15220, 28123, 28124 and SFTP port (default 2121).



## 7.3.5. System Tools

Settings -> Signage Display -> System Tools

Settings system features for signage display.

- (1). Clear Storage
- (2). Reset
- (3). Import & Export
- (4). Clone
- (5). Security
- (6). Admin Password
- (7). Touch lock Password

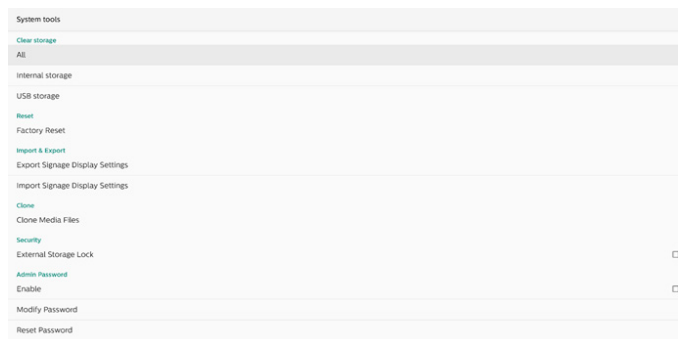

## Clear Storage

Settings -> Signage Display -> System Tools -> Clear Storage

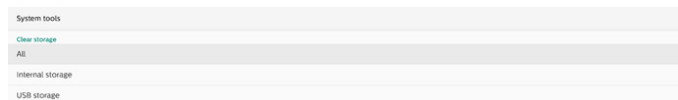

Use to clear all data under {storage}/philips/ folder in internal and external storage

- (1). All: Clear philips/ folder in the internal storage and USB.
- (2). Internal Storage  
Clear philips/ folder in the internal storage only.
- (3). USB Storage  
Clear philips/ folder in the USB storage only.

The folders to be cleared will be listed. Press "RESET" to clear all data under the listed folder. Or press back key to leave and take no further action.

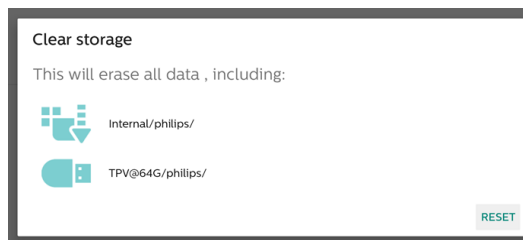

## Reset

Settings -> Signage Display -> System Tools -> Reset

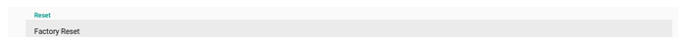

## Factory Reset

Factory reset allows you to clear all user data and settings. The system will auto reboot and jump to OOB after it is finished.

Important Note:

1. All system data will be erased and cannot be reverted, including device settings, installed APPs, APPs' data, download files, music, photos and all data under /data. However, data in USB storage will not be cleared, only data from internal storage will be cleared.
2. Please make sure AC adapter and power are both present during factory reset process. Power off the system only when OOB shows on the screen again.



Tap "Factory Reset" and you will be prompted to confirm the reset action. Note that doing so will erase all data from internal storage and this action cannot be reverted.



## Import & Export

Settings -> Signage Display -> System Tools -> Import & Export

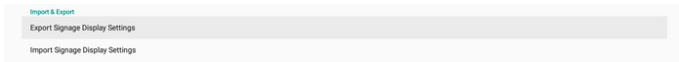

This feature allows you to import database settings and 3rd party APK to other devices. Please note that:

- (1). Export data to BDL3751T-clone.zip file under {storage}/philips/clone folder.
- (2). Support the old cloning method of files and place them under {storage}/philips/sys\_backup:
  - a. AndroidPDMediaPlayerData.db
  - b. AndroidPDPdfData.db
  - c. menu\_settings.db
  - d. settings\_global.xml
  - e. settings\_secure.xml
  - f. settings\_system.xml
  - g. signage\_settings.db

The latest exported data will be archived in a ZIP file.

- (3). "Signage Display Name" will not be imported/exported.

## Export Signage Display Settings

System exports data and third party APKs into {storage}/philips/clone/ BDL3751T -clone.zip file in the selected storage (internal storage, USB storage).

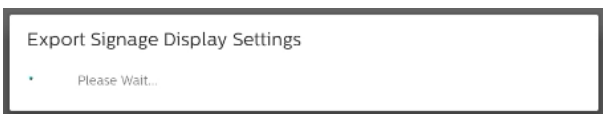

### Note:

If the selected storage (internal storage, USB external storage) does not contain philips/ folder, the system will create it automatically.

All available storage media are listed for user to select.

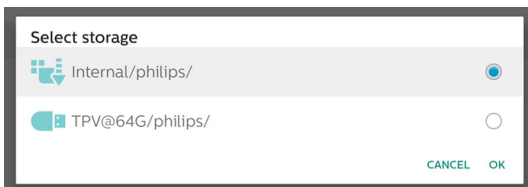

## Import Signage Display Settings

Import data from philips/clone/BDL3751T-clone.zip file of selected storage (internal Storage or USB storage). System imports the following data in ZIP file:

- (1). Import Database in BDL3751T-clone.zip
- (2). Import 3<sup>rd</sup> party APK in BDL3751T-clone.zip
- (3). Import scaler OSD settings in BDLBDL3751T\_clone.zip

All available storage media are listed (internal storage and USB).



A dialog box appears to ask the user to confirm the importing operation. Click "OK" to start importing data.

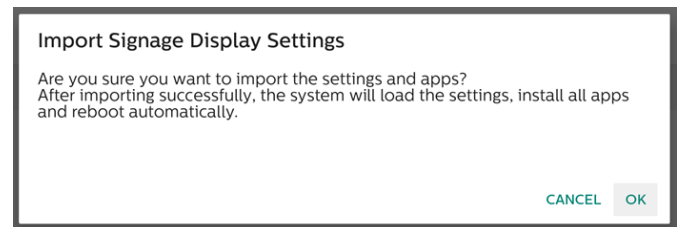

## Clone

Settings -> Signage Display -> System Tools -> Clone

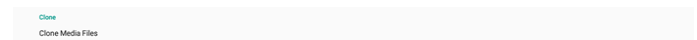

## Clone Media Files

Clone media files from the selected source storage to target storage.

- (1). System clone files under the following list of folder:
  - a. philips/photo
  - b. philips/music
  - c. philips/video
  - d. philips/pdf
  - e. philips/browser



## Security

Settings -> Signage Display -> System tools -> Security

## External Storage Lock

Click the checkbox to lock or unlock external storage (USB storage). Default is unlocked.

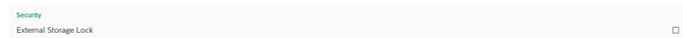

### Note:

When you disable external storage lock for enable state, please unplug and plugin external storage again (for USB storage). After that, system can detect external storage again.

## Admin Password

Settings -> Signage Display -> System tools -> Admin Password

To improve security and comply with U.S. and EU regulations, eliminate the use of default passwords and mandate user-driven password creation.

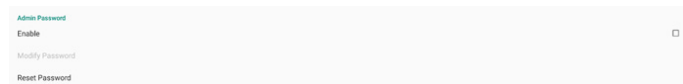

### Enable

If Enable checkbox is not checked, it means the password is empty now.

You can click the checkbox and input the new password.

### Note:

The password rule is 6-digits, no consecutive, no repeating numbers.

Ex: 112233、123457、654322 (ok)

123456、111111、654321 (no)

(1). Unchecked: Disable.

(2). Checked: Enable.

### Note:

After enabling, you need password to login Admin Mode.

## Modify Password

Settings -> Signage Display -> System tools -> Admin Password -> Modify Password.

User can change the password for logging into Admin Mode by following the steps below:

(1). Enter the current password first.

If the current password is not correct, you will see an "Incorrect password" toast message.

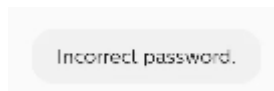

(2). Enter a new password.

(3). Enter the new password again.

Try again if the new password is not correct.

If the password is changed successfully, you will see a "Successful" toast message.

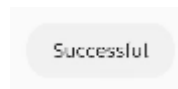

## Reset password

Settings -> Signage Display -> System tools -> Admin Password -> Reset Password.

Reset the password to default "1234". If succeed, you will see a "Successful" toast message.

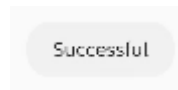

## Touch lock Password

Settings -> Signage Display -> System tools -> Touch lock Password

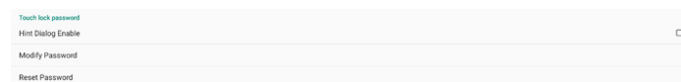

### Hint Dialog Enable

Click the checkbox to enable or disable touch password dialog. Default is enable.

(1) Unchecked: Disable.

(2) Checked: Enable.

### Note:

After enabling, you need password to do touch unlock. Default password is "123".

## Modify Password

You could change the password if need password for login Admin Mode. Follow below steps:

- (1). Enter current password first. Default password is "1234"

(1)

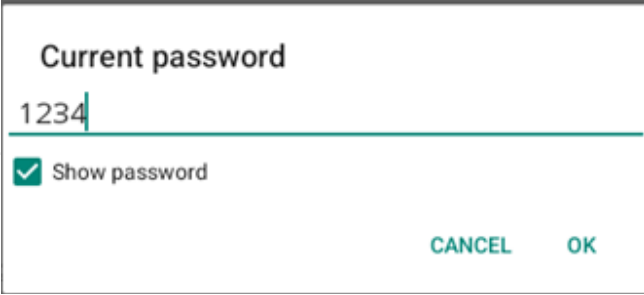

If current password not correct, you will see an Android Toast "Incorrect password" message.

- (2). Enter new password.

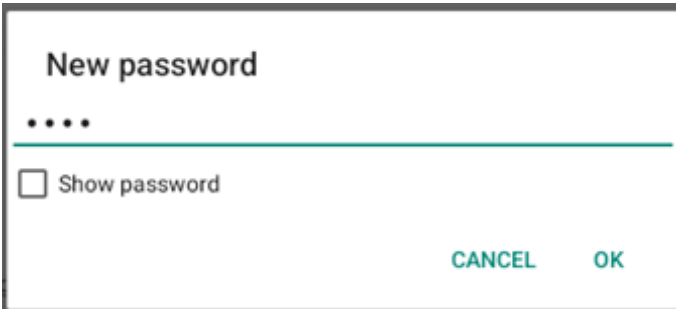

Enter new password again.

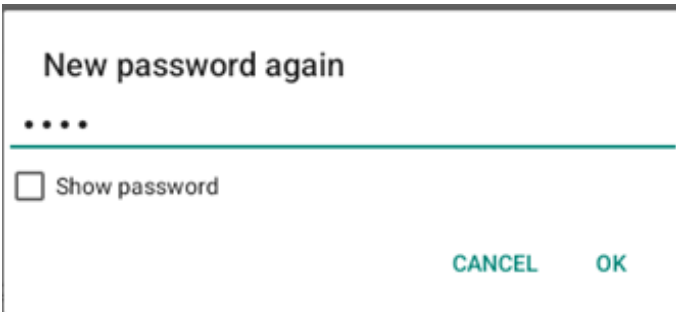

If new password again not match new password, you need to try again.

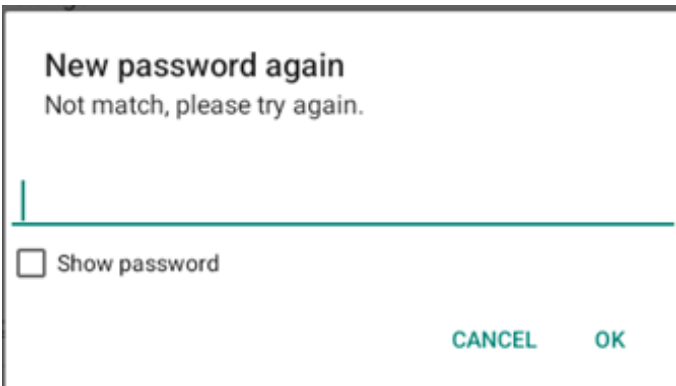

If change password successfully, you will see an Android Toast "Successful" message.

## Reset Password

You could reset the password to default "1234". If success, you will got a "Successful" message.

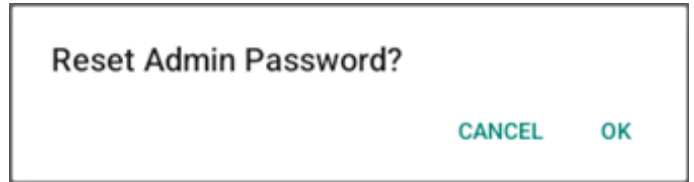

### 7.3.6. Misc.

#### TeamViewer support

Enable or disable TeamViewer support. TeamViewer will send a virtual HOME key to open Admin mode. Default is enable.

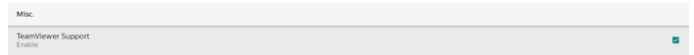

TeamViewerHost APKs will automatically install into the system. Otherwise, system will remove them if "TeamViewer Support" is disabled.

The following APK will be listed in Settings->Apps if TeamViewer support is enabled.



#### Enable logging

Enable or disable logging with checkbox.

Once enabled, PD will start logging android logical log, kernel message and saved them into USB or internal storage automatically. The first priority is USB storage. if there are no any connected usb devices on PD, all data will then saved into internal storage.

The saved path will be: {root directory of USB storage}/ philips/Log/xxBDL3751T-Log-{ yyyy-MM-dd-HH-mm-ss }  
Or {root directory of internal storage}/ philips/Log/ xxBDL3751T-Log-{ yyyy-MM-dd-HH-mm-ss }

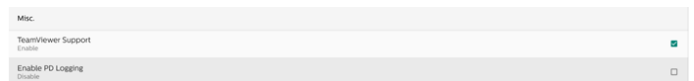

If disabling logging, all data will be saved to a zip file like: {root directory of USB storage}/philips/Log/xxBDL3751T-Log-{ yyyy-MM-dd-HH-mm-ss }.zip

Or {root directory of internal storage}/ philips/Log/ xxBDL3751T-Log-{ yyyy-MM-dd-HH-mm-ss }.zip

#### Enable 4K

Change the display resolution to 4K@30 or 1080P via the check box.

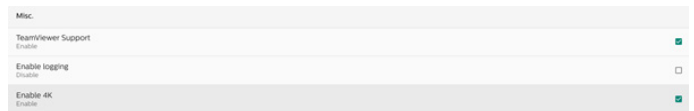

### 7.3.7. System updates

Upgrade the system from storage.

#### Local update

Settings -> Signage Display -> System updates -> Local update

The system will automatically search for "update.zip" or "combofw.zip" files in the root directory of the USB disk or the root directory of the internal storage. If either "update.zip" or "combofw.zip" is found, a selectable list will pop up for the user to choose which file to use for the update.

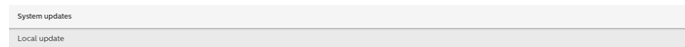

(1). "update.zip"

After selecting the file from the list, the system will reboot and proceed with the system update. Please note that downgrading Android is not supported.

(2). "combofw.zip"

After selecting the file from the list, the system will first start Scaler FW update and then automatically begin the Android system update upon restarting. The "combofw.zip" file has the following two structures:

- "update.zip" + "PHL\_{model name}.bin".
- "update.zip" + "{multi-size scaler}.zip" or "update.zip" + "{multi-size scaler}.7z".

Please note that:

- a. Keep the system powered on during the update process; do not remove the power adapter.
- b. Currently, the system only supports full Android updates.
- c. Update files must be named either "update.zip" or "combofw.zip".
- d. The "update.zip" or "combofw.zip" file must be placed in the root folder of the external or internal storage.

### 7.3.8. Scaler FW updates

#### 7.3.8.1. Start update

Settings -> Signage Display -> Scaler FW updates -> Start update

System will auto search "PHL\_{model name}.bin" in root folder of USB disk or root of internal storage. If system found, pop-up a selectable list for user select which file user wants to use for update.

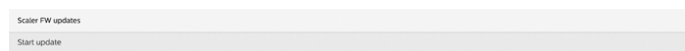

After select the file in list, system will reboot and do Scaler FW update.

Please note that:

- a. Keep system power alive during Scaler FW update, do not remove power adapter.

## 7.4. Apps

Application information and notification settings for installed application in the system.

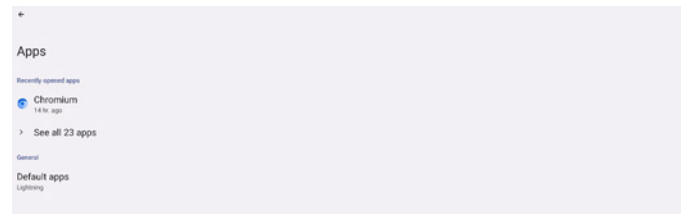

### 7.4.1. See All Apps

List all applications installed in the system. Then, check the current settings and information for each app, such as notification, permission, storage & cache, network usage and other settings.

## 7.5. Display

Settings -> Display

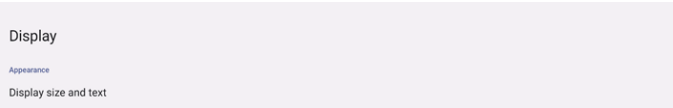

### 7.5.1. Font size

Set the system's default font size.

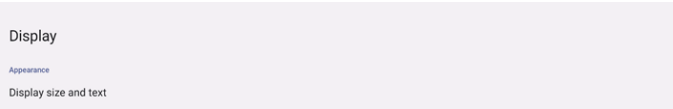

#### Font size

Settings -> Display -> Display size and text -> Font size

Move the slider to make the text on screen smaller or larger.



#### Display size

Settings -> Display -> Display size and text -> Display size

Move the slider to make the UI on screen smaller or larger, including layout and text.



## 7.6. Accessibility

Accessibility services are apps that can help users with disabilities or special needs to interact with their Android device more easily.

In the Downloaded apps menu, you can view all the accessibility apps that are installed on the device, and enable or disable them as needed. You can also access the settings for each individual accessibility app by tapping on its name in the list.

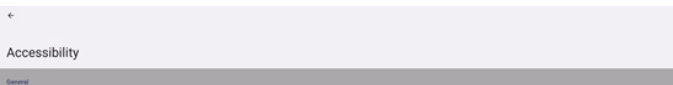

## 7.7. Security

Android system security settings.

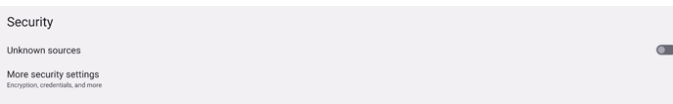

### 7.7.1. Unknown sources

Enable this option to allow 3<sup>rd</sup> party application installation.

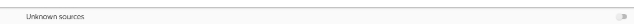

### 7.7.2. More security settings

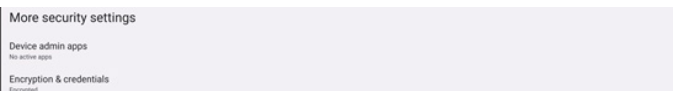

### 7.7.3. Device admin apps

Settings->Security->More security settings->Device admin apps

List and control installed device admin applications, if installed.

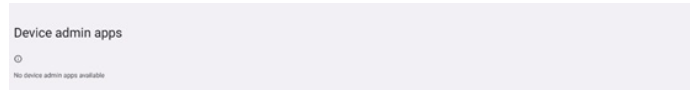

### Encryption & credentials

Settings->Security->More security settings-> Encryption & credentials

This will display a list of all trusted certs on the device.

User can install/uninstall certificates by themselves.

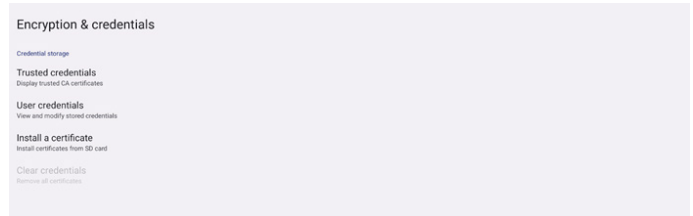

## 7.8. System

The following options are listed in Settings -> System.

- (1). Languages & input
- (2). Date & time
- (3). Developer options

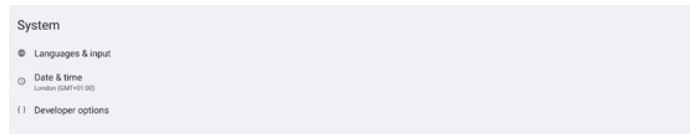

### 7.8.1. Languages & input

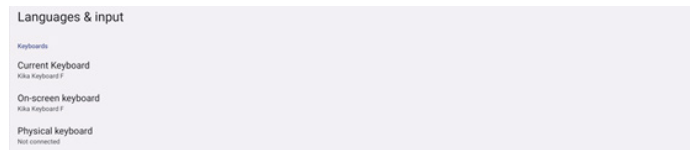

#### 7.8.1.1. Keyboards

Settings -> System -> Languages & input ->Keyboards

User can change IME and keyboard settings here.

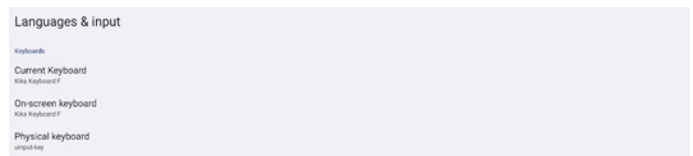

#### Current keyboard

List all available keyboards to set up default keyboard.

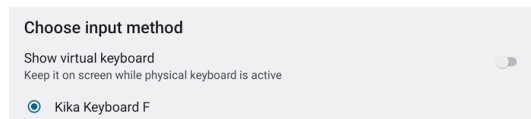



### 7.8.1.2. On-Screen keyboard

Let user can set default software IME (Virtual keyboard) and control detail IME settings.

The Japanese IME will auto be installed when user select Japanese language in OOB.E.

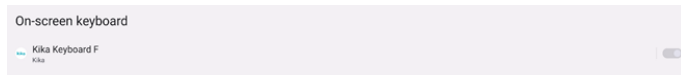

### 7.8.1.3. Physical keyboard

Settings -> System -> Languages & input ->Physical keyboard

Let user control physical keyboard and detail keyboard settings.

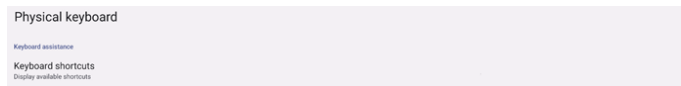

Keyboard shortcuts refer to key combinations that allow users to quickly perform specific actions or navigate through the device, especially when using an external keyboard (e.g., Bluetooth or USB keyboard). There are both system and application shortcuts listed in below picture.

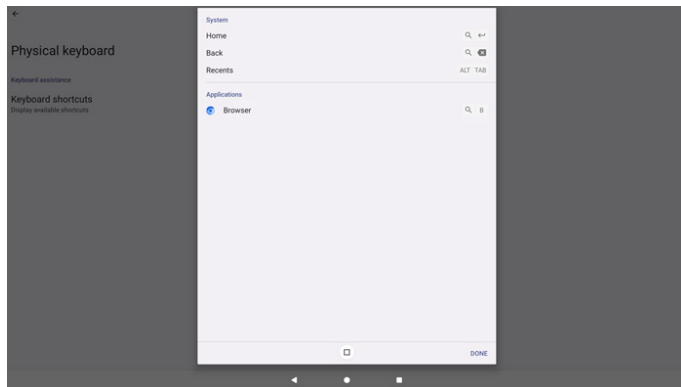

### 7.8.2. Date & Time

Settings -> System -> Date & Time

User can change time zone and NTP server.

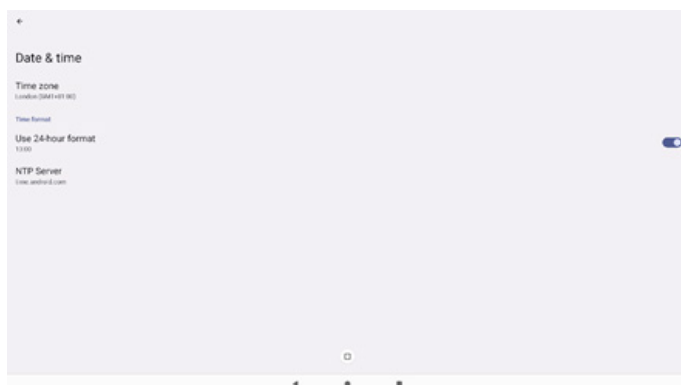

### Time zone

Allow user to choose the time zone.

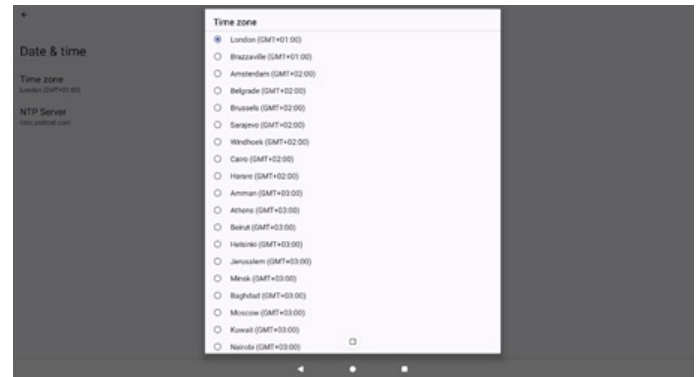

### NTP Server

Allow user to edit the NTP server in the prompted dialog.

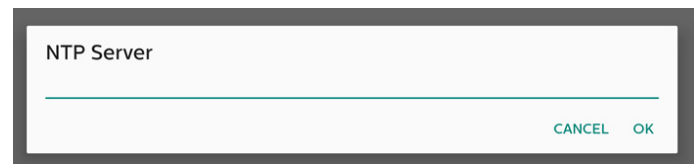

### Use 24-hour format

Decide whether to use the 24-hour clock or the 12-hour clock

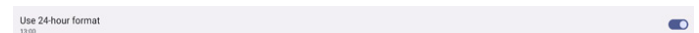

### 7.8.3. Developer options

Android system developer options for engineer development.



### 7.9. About

Settings -> About

Shows system legal information, Model, Android version , Up time, and Build number.

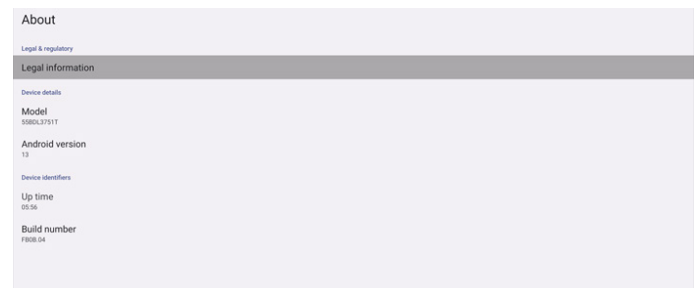

Following information shows in about page:

1. Legal information



2. Model (model name of this device)
3. Android version
4. Up time
5. Build number (release version)

### 7.9.1. Legal Information

Shows the open source licenses, third-party licenses, system WebView licenses and Wallpapers license.



### 7.9.2. Model

Shows the model name of this product.

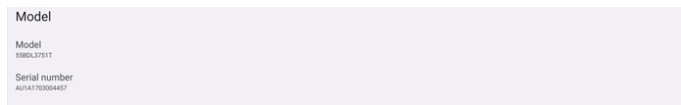

### 7.9.3. Android version

Shows the Android version of this product.

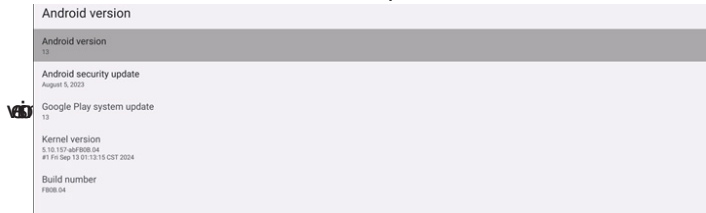

### 7.9.4. Up time

The total amount of time that the device has been powered on and running without being restarted or turned off.

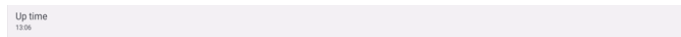

### 7.9.5. Build number

Shows the firmware version of the signage display.

## 8. OSD Menu

An overview of the On-Screen Display (OSD) structure is shown below. You can use it as a reference for further adjustment of your display.

### 8.1. Navigating the OSD Menu

#### 8.1.1. Navigating the OSD menu using the remote control

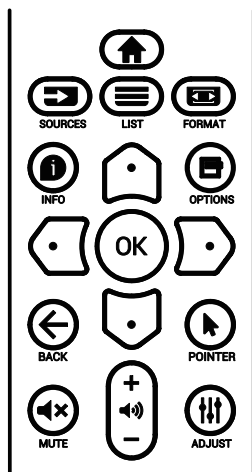

1. Press [**HOME**] button on the remote control to display the OSD menu.
2. Press [**RIGHT**] or [**LEFT**] button to select the item to adjust.
3. Press [**OK**] or [**DOWN**] button to enter the submenu.
4. In the submenu, press [**RIGHT**] or [**LEFT**] button to toggle between items, press [**LEFT**] or [**DOWN**] button to adjust the settings. If there is a submenu, press [**OK**] or [**DOWN**] button to enter the submenu.
5. Press [**LEFT**] button to return to the previous menu, or press [**HOME**] button to exit from the OSD menu.

#### 8.1.2. Navigating the OSD menu using the display's control buttons

1. Press [**MENU**] button to display the OSD menu.
2. Press [**+**] or [**-**] button to select the item to adjust.
3. Press [**+**] button to enter the submenu.
4. In the submenu, press [**▲**] or [**▼**] button to toggle between items, press [**+**] or [**-**] button to adjust settings. If there is a submenu, press [**+**] button to enter the submenu.
5. Press [**MENU**] button to return to the previous menu, or keep pressing [**MENU**] button to exit from the OSD menu.

## 8.2. OSD Menu Overview

### 8.2.1. Picture menu

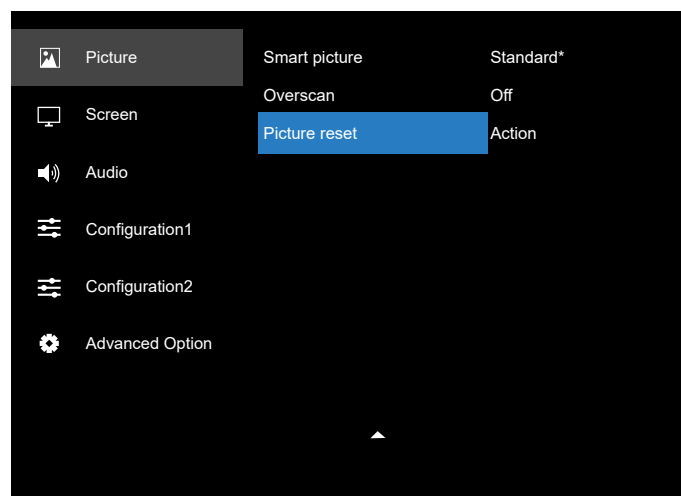
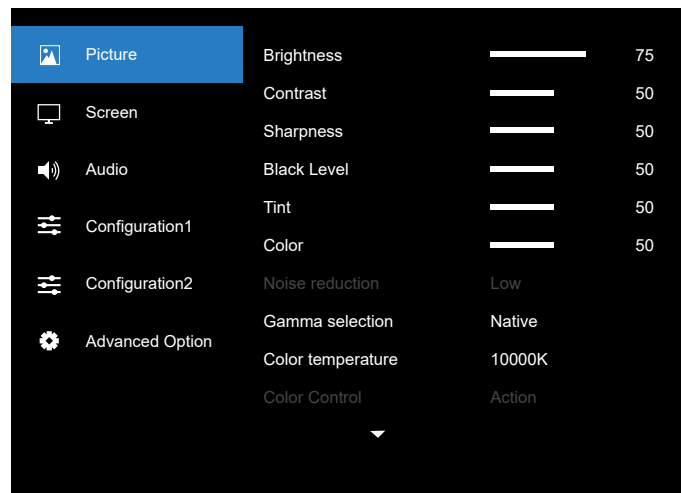

#### Brightness

Adjust the brightness of this display's backlight.

#### Contrast

Adjust the contrast ratio for the input signal.

Note: VIDEO source only.

#### Sharpness

Reserved.

#### Black level

Adjust the image brightness for the background.

Note: VIDEO source only. sRGB picture mode is standard and cannot be changed.

#### Tint (Hue)

Adjust the tint of the screen.

Press + button the flesh tone color becomes greenish.

Press - button the flesh tone color becomes purplish.

Note: VIDEO source only.

#### Color (Saturation)

Adjust the color of the screen.

Press + button to increase color depth.

Press - button to decrease color depth.

Note: VIDEO source only

### Noise reduction

Reserved.

### Gamma selection

Select a display gamma. It refers to the brightness performance curve of signal input. Choose from {Native} / {2.2} / {2.4} / {s gamma} / {D-image}.

Note: VIDEO source only. sRGB picture mode is standard and cannot be changed.

### Color temperature

Adjust the color temperature.

The image becomes reddish as the color temperature decreases, and becomes bluish as the color temperature increases.

Note: VIDEO source only.

### Color Control

The color levels of red, green, and blue can be adjusted by the color bars.

R: Red gain, G: Green gain, B: Blue gain.

### Smart picture

The following smart picture modes are available for:

- PC mode: {Standard} / {Highbright} / {sRGB}.
- Video mode: {Standard} / {Highbright} / {Cinema}.

### Overscan

If you encounter problems with overscanning, you can change display area of the image.

- {ON}: Display 95% of the total image area.
- {OFF}: Display 100% of the total image area.

Note: VIDEO source only.

### Picture reset

Reset all settings in the Picture menu.

Select "RESET" to restore factory preset data.

Press "CANCEL" button to cancel and then return to the previous menu.

## 8.2.2. Screen menu

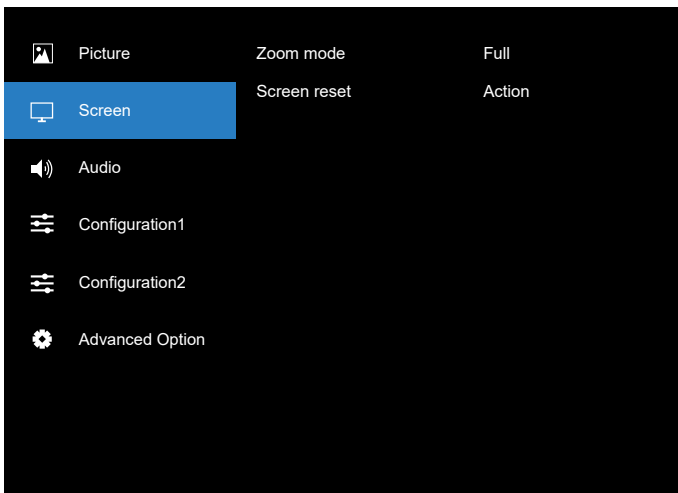

## Zoom mode

Choose one for video input: {Full} / {4:3} / {1:1} / {16:9} / {21:9}.

	<b>Full</b> This mode restores the correct proportions of pictures transmitted in 16:9 using the full screen display.
	<b>4:3</b> The picture is reproduced in 4:3 format and a black band is displayed on either side of the picture.
	<b>1:1</b> This mode displays the image pixel-by-pixel on screen without scaling the original image size.
	<b>16:9</b> The picture is reproduced in 16:9 format and a black band at the top and bottom.
	<b>21:9</b> The picture is reproduced in 21:9 format and a black band at the top and bottom.

## Screen reset

Reset all settings in the Screen menu to factory preset values.

## 8.2.3. Audio menu

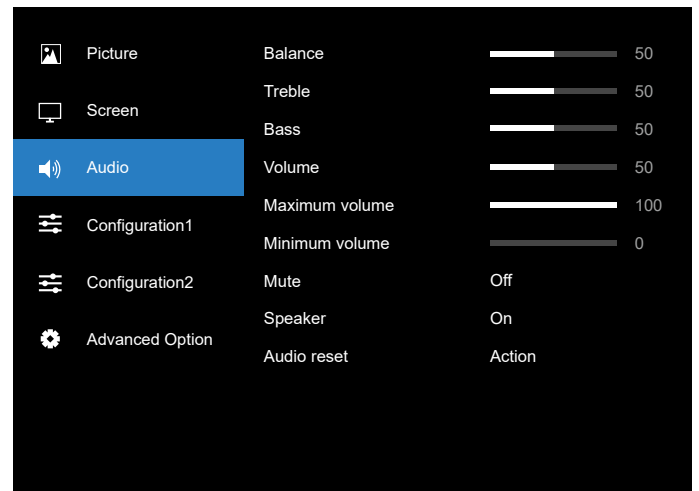

### Balance

Adjust to emphasize left or right audio output balance.

Note: Only can adjust balance for speaker output.

### Treble

Adjust to increase or decrease higher-pitched sounds.

### Bass

Adjust to increase or decrease lower-pitched sounds.

### Volume

Adjust the volume.

### Maximum volume

Adjust limitation for the maximum volume setting.

**Minimum Volume**

Adjust limitation for the minimum volume setting.

**Mute**

Turn the mute function on/off.

**Speaker**







Turn the internal speaker on/off.

NOTE: This function is only available when {Sync. Volume} is on.

**Audio reset**

Reset all settings in the Audio menu to factory preset values.

**8.2.4. Configuration1 menu**

	Picture	Switch on state	Force on
	Screen	Panel saving	Action
	Audio	RS232 routing	RS232
	Configuration1	Boot on source	Action
	Configuration2	WOL	Off
	Advanced Option	Light sensor	Off
		Human sensor	Off
		Power LED Light	On
		Configuration1 reset	Action
		Factory reset	Action

**Switch on state**

Select the display status when you connect the power cord next time.

- {Power off} - The display will remain off when the power cord is connected.
- {Forced on} - The display will turn on when the power cord is connected.
- {Last status} - The display will return to the previous power status (on/off/standby mode) when the power cord is connected.

**Panel saving**

Choose to enable the panel saving functions and thus reduce the risk of image persistence or ghost imaging.

- {Brightness} - Select {On} and the image brightness will reduce to an appropriate level. The Brightness setting in the Picture menu cannot be changed when this setting is enabled.
- {Pixel Shift} - Select the time interval ({Auto}, {10-900} seconds, {Off}) for display to slightly expand the image size and shift the position of pixels in four directions (up, down, left and right). Activating pixel shift will disable H position, V position and Zoom mode in Screen menu.

Note: Video source only.

**RS232 routing**

Select RS232 routing path

- {RS232} – RS232 is routed from 2.5mm phone jack
- {LAN->RS232} – RS232 is routed from RJ45
- {OPS RS232} – RS232 is routed from OPS

**Boot on source**

Choose to select a source when booting up.

- {Input} – Select input source when booting up.
- {Playlist} – Select playlist index for Media Player, Browser. 0 indicates there is no playlist.

**WOL (Wake on LAN)**

Allow the display to be turned on by a network message.

Note: This function only works in power save mode 1.

**Light sensor**

Choose to turn on or off the light sensor function.

**Human sensor**

Choose to turn on or off the human sensor function.

**Configuration1 reset**

Reset all settings in Configuration menu to factory preset values.

**Power LED Light**

Choose to set power indication LED on or off.

Choose {On} for normal use.

**Factory Reset**

Reset all customized settings in Picture, Screen, Audio, Configuration and Advanced Option to the factory default values.

## 8.2.5. Configuration2 menu

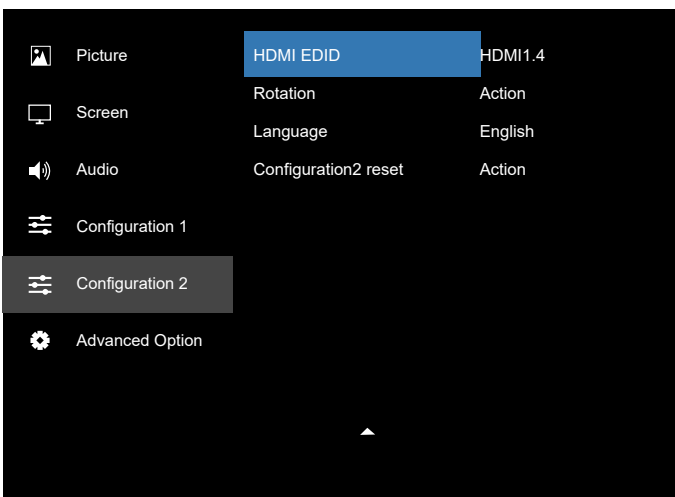
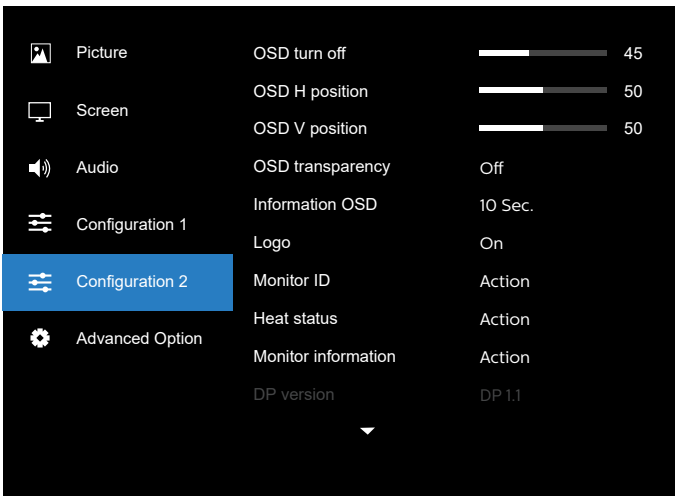

### OSD turn off

Set the period of time the OSD (on-screen display) menu stays on the screen.

The options are: {5 ~ 120} seconds.

### OSD H-position

Adjust the horizontal position of OSD menu.

### OSD V-position

Adjust the vertical position of OSD menu.

### OSD Transparency

Adjust OSD transparency.

- {Off} - Transparency off.
- 20/40/60/80/100.

### Information OSD

Set the period of time the information OSD display on the screen. The options are {Off, 1-60} seconds.

### Logo

Choose to enable or disable the picture of Logo when turning on your display.

The options are:

- {Off}
- {On}
- {User}

NOTE: If it is set to {USER}, the rotation function is not supported for user logo.

### Monitor ID

Set ID number for controlling the display via the RS232C connection. Each display must have a unique ID number when multiple sets of display are connected. Monitor ID number range is between 1 to 255.

The option are: {Monitor group} / {Tiling matrix} / {Auto ID}

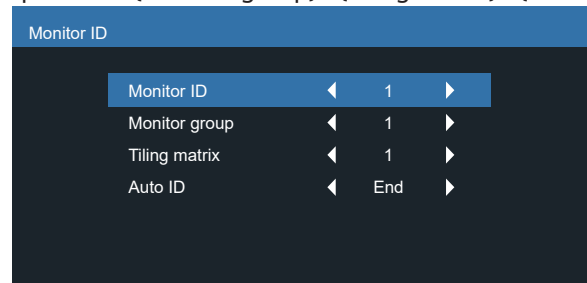

- {Monitor group}

The options are: {1-255}. The default setting is 1.

- {Tiling matrix}

Tiling matrix number range is between 1 to 15. 1 is the default setting. The {Auto ID} setup function enables setting up {Monitor ID} of connected machine according to {Tiling matrix} settings.

Example: Tiling matrix sets to 4

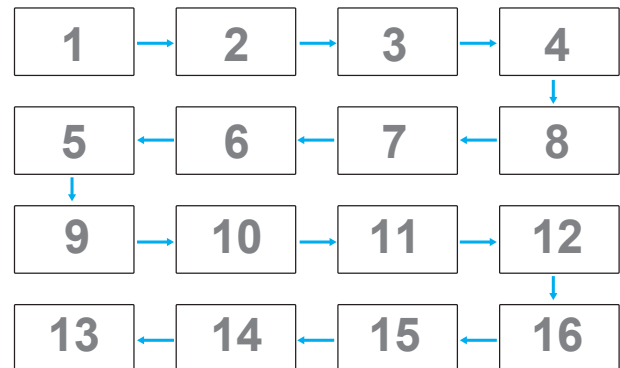

- {Auto ID}

The option are: {Start} / {End}. The default setting is {End}.

- Switch to Start to set up the IDs of machines backward from current one.
- Once the setup is completed, the option exits from End automatically.
- To use this function, serially connect all machines with RS-232 cable and set their Control ports to RS-232 too.

### Heat status

This function allows you to check the thermal status of display at any time.

## Monitor information

Show information about your display, including model number, serial number, operating hours and software version.

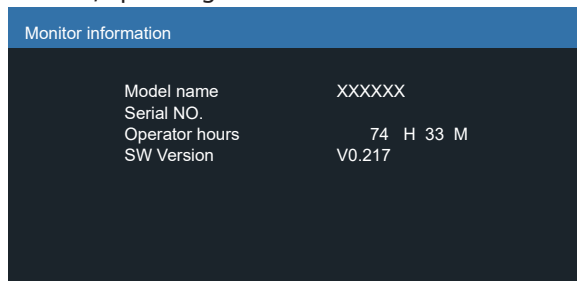

## DP Version

The options are: {DP 1.1} / {DP 1.2}. The default setting is {DP 1.1}.

## HDMI EDID

The option are: {HDMI 1.2} / {HDMI 1.4} / {HDMI 2.0}. The default setting is {HDMI 1.4}.

NOTE: HDMI 2.0 option is to support HDMI 2.0 equipment.

## Rotation

Set the rotation of Main/Sub/OSD

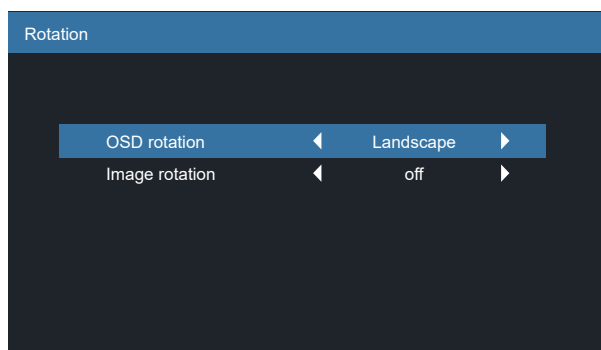

- OSD Rotation : Landscape/Portrait,Default : Landscape  
OSD Rotation: {Off}, {On} when value is on, OSD rotate 90 °, Off is restored.
- Image rotation: Off/On,Default : Off  
Image rotation: {Off}, {On} when value is on, The Android source rotate 90 °, Off is restored

NOTE: The image rotation function only support in the Android source.

## Language

Select the language used in the OSD menu.

The options are: English/Deutsch/ 简体中文 /Français/Italiano/ Español/Русский/PolSKI/Türkçe/ 繁體中文 / 日本語 /Português/ العربية /Danish/Svenska/Suomi/Norsk/Nederlands

## Configuration2 reset

Reset all settings in Configuration2 menu to the factory preset values.

## 8.2.6. Advanced Option menu

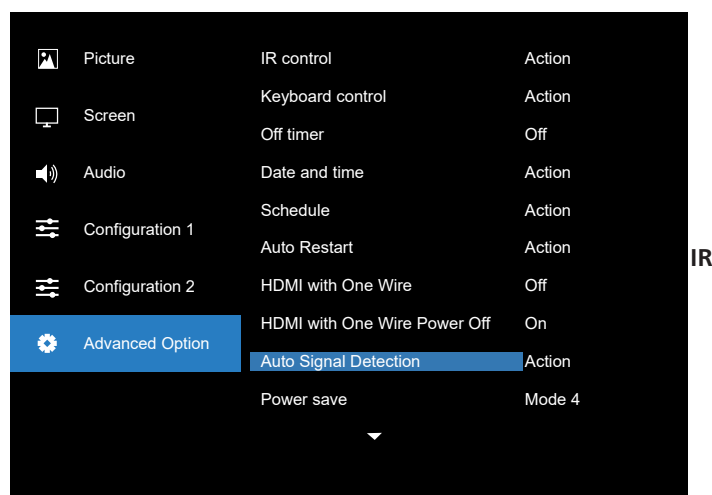

### control

Select the operation mode of the remote control when multiple displays are connected via RS232 connection.

- {Unlock} - All displays can be operated normally by the remote control unit.
- {Lock All} / {Lock all but Volume} / {Lock all but Power} / {Lock all except PWR &VOL} - Lock the remote control function of this display. To unlock, press and hold the INFO button on the remote control for 6 (six) seconds.
- {Primary} - Designate this display as the primary display for remote control operation. Only this display can be operated by the remote control. (In primary mode, IR key will always be processed regardless of the monitor ID/group settings).
- {Secondary} - Designate this display as the secondary display. This display cannot be operated by the remote control, and will only receive the control signal from the primary display via RS232 connection.

### Keyboard control

Choose to enable or disable the display keyboard (control buttons) function.

- {Unlock} - Enable the keyboard function.
- {Lock All} / {Lock all but Volume} / {Lock all but Power} / {Lock all except PWR & VOL} - Disable the keyboard function.

Note: "Keyboard Control Lock Mode" This function completely disables the access to all Keyboard Control functions. To enable or disable the keyboard control lock, press both [VOL+ ] and [UP ] buttons and hold down continuously more than 3 seconds.

### Off timer

Set automatic power off time (in hours).

## Date and time

Adjust the current date and time for the display's internal clock.

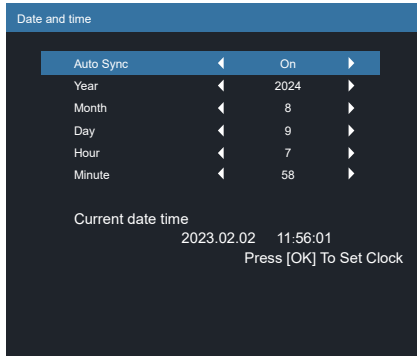

- {Auto Sync} - Auto sync display's clock with NTP server.

## Schedule

This function allows you to program up to 7 (seven) different scheduled time intervals for the display to activate.

You can select:

- The time for the display to turn on and turn off.
- The days in a week for the display to activate.
- Which input source the display will use for each scheduled activation period.

**NOTE:** It is recommended that you set up the current date and time in the {Date and time} menu before using this function.

1. Press [OK] or [D] button to enter the submenu.

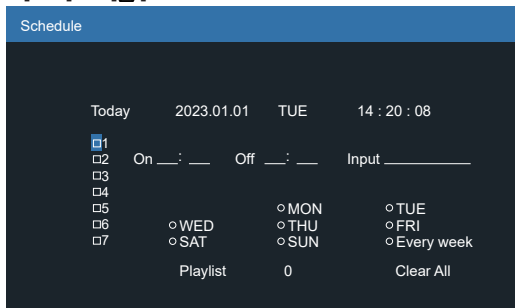

2. Press [△] or [▽] button to select a schedule item (item number 1 ~ 7), and press [OK] button to mark the item number.

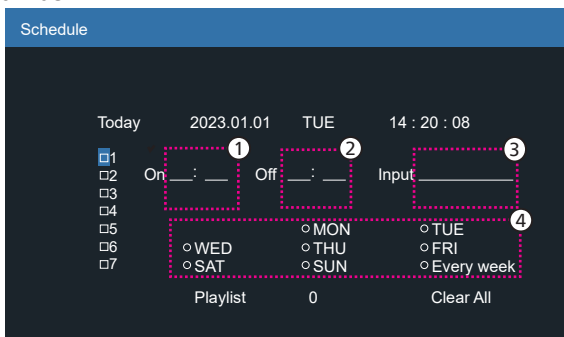

3. Press [←] or [→] button to select the schedule:

- ① Power-on schedule: Press [△] or [▽] button to adjust and the display will turn on at the specified time.

- ② Power-off schedule: Press [△] or [▽] button to adjust and the display will turn off at the specified time.

Leave the hour and minute options empty if you do not want to use the function of power-on or power-off schedule.

- ③ Input-source selection: Press [△] or [▽] button to select an input source. If no input source is selected, the input source will remain the same as the previous one.

- ④ Date schedule: Press [D] button to select which day in a week this schedule item will take effect, then press the [OK] button.

- ⑤ When Input-source select to Media player, Browser or PDF player, enable to access playlist setting.

4. For additional schedule settings, press [←], then repeat the steps above. A check mark in the box next to the number of the schedule item indicates that the selected schedule is in effect.

**NOTES:**

- If the schedules overlap, the scheduled power-on time takes priority over scheduled power-off time.
- If there are two schedule items programmed for the same time, the highest numbered schedule takes priority. For example, if schedule items #1 and #2 both set the display to power on at 7:00 AM and off at 5:00 PM, then only schedule item # 2 will take effect.

## Auto Restart

Define a specific time to restart Android every day

- {Auto Restart} - the option are: {Off} / {On},  
{Off}: Auto restart is disabled  
{On}: Auto restart is enabled
- {Hour} - Select the hour to restart Android.
- {Minute} - Select the minute to restart Android

## HDMI with One Wire

Enable or disable HDMI CEC.

## HDMI with One Wire Power off

Only available if "HDMI with One Wire" is On

- {Off} - System Standby disable.
- {On} - System Standby enables.(Default)

Support

- System Standby enables PD to switch to standby mode with CEC standby Command 0x36.

## Auto signal detection

OPTION:

{Off}, {All}, {Failover}

{Off}: Disable Auto signal detection

{All}: Displayport->HDMI1 -> HDMI2 -> USB TYPE-C -> OPS\* -> Media Player -> Browser -> PDF Player -> Kiosk -> Custom -> Home

OPS\*: Only 43/55BDL3751T Support

\* Not all modules have all source in this list. DVI can be DVI-I or DVI-D

\* Media Player, Browser will only try playlist index 1

{Failover}:

Failover 1: HDMI1 (default)  
 Failover 2: HDMI1 (default)  
 Failover 3: HDMI1 (default)  
 Failover 4: HDMI1 (default)  
 Failover 5: HDMI1 (default)  
 Failover 6: HDMI1 (default)  
 Failover 7: HDMI1 (default)  
 Failover 8: HDMI1 (default)  
 Failover 9: HDMI1 (default)  
 Failover 10: HDMI1 (default)

\* Not all modules have all 10 failover list, depends on total source of module

### Power Save

Power save modes

Mode 1: [TCP off, WOL on, auto off](default)

DC off -> Power off, LED: Red.

Power Save -> Power off, LED: Red

Mode 2: [TCP off, WOL on, auto on/off]

DC off -> Power off, LED: Red.

Power Save -> Power Saving.

LED: Orange. Can be woken up.

Mode 3: [TCP on, WOL off, auto on/off]

DC off -> Back light off, LED: Red

Power Save -> Back light off, LED: Orange. Can be woken up.

Mode 4: [TCP on, WOL off, no auto on/off]

DC off -> Back light off, LED: Red

Power Save -> Will not enter power save mode. It shows "no signal" only.

Mode 3 DC OFF: Backlight Off only Power Save: Backlight Off only	Mode 1(default) DC OFF: Power Off Power Save: Power Off
Mode 4 DC OFF: Backlight Off only Power Save: No signal(Backlight On)	Mode 2 DC OFF: Power Off Power Save: Power Saving

DC off/on: Press power button by RC

### Scalar FW Update

Update scalar FW by USB.

Note: Only USB 2.0 flash disk is supported.

### USB Cloning

Copy PD settings from one set to another.

Import: Import settings from another set.

Export: Export settings to another set.

### OPS settings

Set the OPS configuration under each power condition.

- {Auto} - After selecting {Card OPS} for video source input, the OPS will be set to off when the display power is set to off, or vice versa. If you set to other video source inputs, the OPS will always be set to on.
- {Always off} - The OPS will always be set to off.
- {Always on} - The OPS will always be set to on.

### Advanced option reset

Reset all settings except {Date and Time} in the advanced option menu to factory preset values.

## 8.3. Android Settings

### Open Android Settings

1. When the admin password is enabled from Android Setting -> System tools, it must be entered before accessing the android settings.

Default password is 1234.



## 9. Supported Media Formats

### USB Multimedia Formats

Video format		
Video Codec	Resolution	Bit Rate
MPEG1/2	1080P@60fps	80Mbps
MPEG4	1080P@60fps	80Mbps
H.263	1080P@60fps	80Mbps
H.264	4K2K@120fps	200Mbps
H.265	4K2K@120fps	200Mbps
VP8	1080P@60fps	60Mbps
VP9	4K2K@120fps	100Mbps

Audio format			
Audio Codec	Sampling Rate:	Channel	Bit Rate
MPEG1/2/2.5 Layer3	8KHz-48KHz	2	8Kbps-320Kbps
MPEG1/2 Layer1	16KHz-48KHz	2	32Kbps-448Kbps
MPEG1/2 Layer2	16KHz-48KHz	2	8Kbps-384Kbps
AAC, HEAAC	8KHz-48KHz	5.1	AAC-LC: 12Kbps-576Kbps V1:6Kbps-288Kbps V2:3Kbps-144Kbps

Photo format	
Image	Resolution
JPEG	3840 x 2160
PNG	3840 x 2160
BMP	3840 x 2160
WebP	3840 x 2160

#### NOTES:

- Sound or video may not work if the contents have a standard bit rate/frame rate above the compatible Frame/sec listed in the table above.
- Video content with a Bit rate or Frame rate larger than the rate specified in the table above can cause choppy video during playback.

## 10. Input Mode

### Timing support (Computer formats):

Item	Resolution	Refresh rate
1	720x400	70
2	640x480	60, 67, 75
3	800x600	60
4	832x624	75
5	1024x768	60
6	1152x870	75
7	1280x720	60
8	1920x1080	60
9	1440x900	60
10	1680x1050	60
11	3840x2160	30, 60

### Timing support (Video format):

Item	Resolution	Refresh rate
1	480i, 480p	60
2	576i, 576p	50
3	720p	50, 60
4	1080i, 1080p	50, 60

- The PC text quality is optimum in UHD mode (3840 x 2160, 60Hz).
- Your PC display screen might appear different depending on the manufacturer (and your particular version of Windows).
- Check your PC instruction book for information about connecting your PC to a display.
- If a vertical and horizontal frequency-select mode exists, select 60Hz (vertical) and 31.5KHz (horizontal). In some cases, abnormal signals (such as stripes) might appear on the screen when the PC power is turned off (or if the PC is disconnected). If so, press the [INPUT] button to enter the video mode. Also, make sure that the PC is connected.
- When horizontal synchronous signals seem irregular in RGB mode, check PC power saving mode or cable connections.
- The display settings table complies to the IBM/VESA standards, and based on the analog input.
- The DVI support mode is regarded as same to the PC support mode.
- The best timing for the vertical frequency to each mode is 60Hz.
- In UHD mode (3840 x 2160, 60Hz), Pixel Rate HDMI:594 , TYPE-C:533.25.

## 11. Pixel Defect Policy

We strive to deliver the highest quality products and use some of the industry's most advanced manufacturing processes whilst practicing stringent quality control. However, pixel or sub-pixel defects on the PDP / TFT panels used in Plasma- & LCD- displays are sometimes unavoidable. No manufacturer can guarantee that all panels will be free from pixel defects, but Philips guarantees that any Plasma- & LCD- displays with an unacceptable number of defects will be repaired during the warranty period in line with your local guarantee conditions.

This notice explains the different types of pixel defects and defines the acceptable defect level for the LCD screen. In order to qualify for repair under warranty, the number of pixel defects must exceed a certain level as shown in the reference table. If the LCD screen is within specification a warranty exchange / claim back will be refused. Additionally, because some types or combinations of pixel defects are more noticeable than others, Philips sets even higher quality standards for those.

### 11.1. Pixels and Sub-Pixels

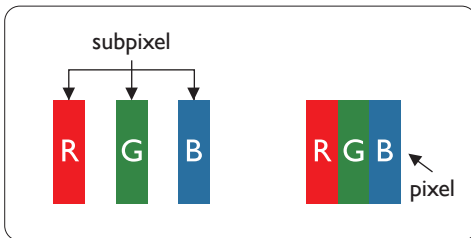

A pixel, or picture element, is composed of three sub-pixels in the primary colors of red, green and blue. Many pixels together form an image. When all sub-pixels of a pixel are lit, the three colored sub-pixels together appear as a single white pixel. When all are dark, the three colored sub-pixels together appear as a single black pixel. Other combinations of lit and dark sub-pixels appear as single pixels of other colors.

### 11.2. Types of Pixel Defects + Dot Definition

Pixel and sub-pixel defects appear on the screen in different ways. There are three categories of pixel defects and several types of sub-pixel defects within each category.

Dot definition = What is a defective "Dot"?:

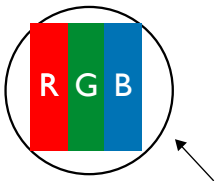

One or more defective, adjacent sub-pixel are defined as one "dot". The no. of defective sub-pixels are not relevant to define a defective dot. This means that a defective dot can consist of one, two or three defective sub-pixels which can be dark or lit.



One dot = One Pixel; consists of three sub-pixels of Red, Green, and Blue.

### 11.3. Bright Dot Defects

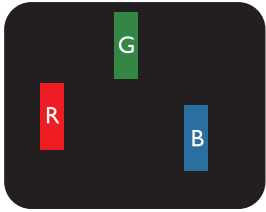
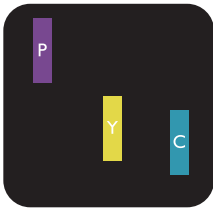
Bright dot defects appear as pixels or sub-pixels that are always lit or "on". These are the examples of bright dot defects:

 <p>One lit red, green or blue sub pixel</p>	 <p>Two adjacent lit sub pixels: Red + Blue = Purple Red + Green = Yellow Green + Blue = Cyan (Light Blue)</p>	 <p>Three adjacent lit sub pixels (one white pixel)</p>
---	---	--

## 11.4. Dark Dot Defects

Black dot defects appear as pixels or sub-pixels that are always dark or "off". These are the examples of black dot defects:

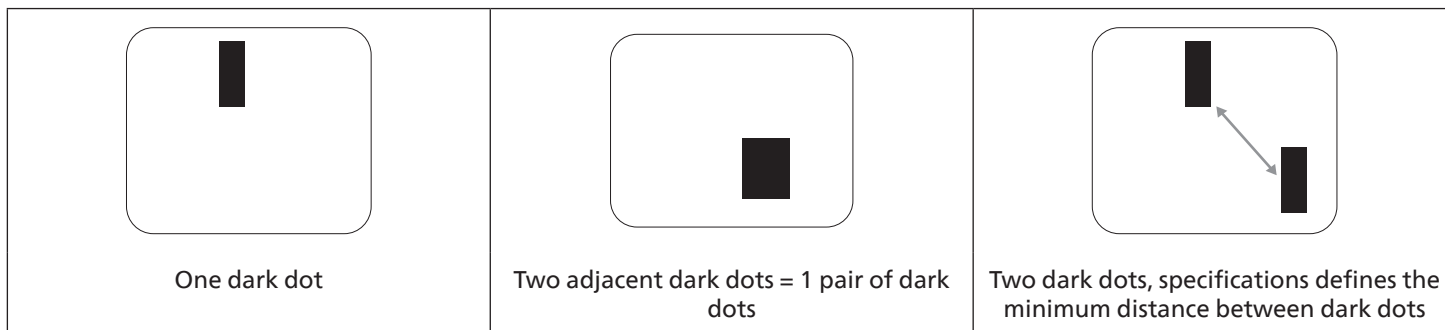

## 11.5. Proximity of Pixel Defects

Because pixel and sub-pixels defects of the same type that are nearby one another may be more noticeable, Philips also specifies tolerances for the proximity of pixel defects. In the table below you can find specifications about:

- Allowed amount of adjacent dark dots = (adjacent dark dots = 1 pair of dark dots)
- Minimum distance between dark dots
- Total no. of all defective dots

## 11.6. Pixel Defect Tolerances

In order to qualify for repair due to pixel defects during the warranty period, a PDP / TFT panel in a Philips Plasma / LCD- display must have pixel or sub-pixel defects exceeding the tolerances listed in the following table.

BRIGHT DOT EFFECT	ACCEPTABLE LEVEL
1 lit sub pixel	2
BLACK DOT EFFECT	ACCEPTABLE LEVEL
1 dark sub pixel	10
TOTAL DOT DEFECTS OF ALL TYPES	12

Note: \* 1 or 2 adjacent sub pixel defects = 1 dot defect

## 11.7. MURA

Dark spots or patches may occasionally appear on some liquid crystal display (LCD) panels. This is known within the industry as Mura, which is a Japanese term for "unevenness." It is used to describe an irregular pattern or area in which uneven screen uniformity appears under certain conditions. Mura is a result of the deterioration of the liquid crystal alignment layer and is most commonly caused by long-term operation under high ambient temperatures. It is an industry- wide phenomenon and Mura is not repairable. It is also not covered by our warranty terms.

Mura has been around since the introduction of LCD technology and with screens getting bigger and in operation 24/7, many displays are running in low light conditions. This all adds to the possibility of Mura affecting displays.

### HOW TO SPOT MURA

There are many symptoms of Mura and also multiple causes. Several of these are listed below:

- Impurities or foreign particles in the crystal matrix
- Uneven distribution of LCD matrix during manufacturing
- Non-uniform luminance distribution of the backlight
- Panel assembly induced stress
- Flaws within the LCD cells
- Thermal induced stress - high temperature operation over long periods of time

### HOW TO AVOID MURA

Although we can not guarantee the complete eradication of Mura every time, in general the appearance of Mura can be minimized by these methods:

- Lower the backlight brightness
- Use a screen saver
- Reduce the ambient temperature around the unit

## 12. Cleaning and Troubleshooting

### 12.1. Cleaning

#### Caution When Using the Display

- Do not bring your hands, face or objects close to the ventilation holes of the display. The top of the display is usually very hot due to the high temperature of exhaust air being released through the ventilation holes. Burns or personal injuries may occur if any body parts are brought too close. Placing any object near the top of the display could also result in heat related damage to the object as well as the display itself.
- Be sure to disconnect all cables before moving the monitor. Moving the monitor with its cables attached may damage the cables and thus cause fire or electric shock.
- Disconnect the power plug from the wall outlet as a safety precaution before carrying out any type of cleaning or maintenance procedure.

#### Front Panel Cleaning Instructions

- The front of the display has been specially treated. Wipe the surface gently using only a cleaning cloth or a soft, lint-free cloth.
- If the surface becomes dirty, soak a soft, lint-free cloth in a mild detergent solution. Wring the cloth to remove excess liquid. Wipe the surface of the display to remove dirt. Then use a dry cloth of the same type to dry.
- Do not scratch or hit the surface of the panel with fingers or hard objects of any kind.
- Do not use volatile substances such as insert sprays, solvents and thinners.

#### Cabinet Cleaning Instructions

- If the cabinet becomes dirty, wipe the cabinet with a soft, dry cloth.
- If the cabinet is extremely dirty, soak a lint-free cloth in a mild detergent solution. Wring the cloth to remove as much moisture as possible. Wipe the cabinet. Use another dry cloth to wipe over until the surface is dry.
- Do not use solution that contains oil to clean the plastic parts. Such product damage the plastic parts and void the warranty.
- Do not allow any water or detergent to come into contact with the surface of the display. If water or moisture gets inside the unit, operating problems, electrical and shock hazards may result.
- Do not scratch or hit the cabinet with fingers or hard objects of any kind.
- Do not use volatile substances such as insert sprays, solvents and thinners on the cabinet.
- Do not place anything made from rubber or PVC near the cabinet for any extended periods of time.

## 12.2. Troubleshooting

Symptom	Possible Cause	Remedy
No picture is displayed	<ol style="list-style-type: none"> <li>1. The power cord is disconnected.</li> <li>2. The main power switch on the back of the display is not switched on.</li> <li>3. The selected input has no connection.</li> <li>4. The display is in the standby mode.</li> </ol>	<ol style="list-style-type: none"> <li>1. Plug in the power cord.</li> <li>2. Make sure that the power switch is switched on.</li> <li>3. Connect a signal connection to the display.</li> </ol>
Interference displayed on the display or an audible noise is heard	Caused by surrounding electrical appliances or fluorescent lights.	Move the display to another location to see if the interference is reduced.
Color is abnormal	The signal cable is not connected properly.	Make sure that the signal cable is attached firmly to the back of the display.
Picture is distorted with abnormal patterns	<ol style="list-style-type: none"> <li>1. The signal cable is not connected properly.</li> <li>2. The input signal is beyond the capabilities of the display.</li> </ol>	<ol style="list-style-type: none"> <li>1. Make sure that the signal cable is attached firmly.</li> <li>2. Check the video signal source to see if it is beyond the range of the display. Please verify its specifications with this display's specification section.</li> </ol>
Display image doesn't fill up the full size of the screen	<ol style="list-style-type: none"> <li>1. The zoom mode is not set correctly.</li> <li>2. Scan Mode may be set incorrectly to underscan.</li> <li>3. If the image exceeds the screen size, Scan Mode may need to be set to Underscan.</li> </ol>	Use the Zoom mode or Custom zoom function in the Screen menu to fine tune display geometry and time frequency parameter.
Can hear sound, but no picture	Source signal cable is connected improperly.	Make sure that both video inputs and sound inputs are correctly connected.
Can see picture but no sound is heard	<ol style="list-style-type: none"> <li>1. Source signal cable is connected improperly.</li> <li>2. Volume is turned all the way down.</li> <li>3. {Mute} is turned on.</li> <li>4. No external speaker is connected.</li> </ol>	<ol style="list-style-type: none"> <li>1. Make sure that both video inputs and sound inputs are connected correctly.</li> <li>2. Press [⊕] or [⊖] button to hear sound.</li> <li>3. Switch MUTE off by using the [MUTE] button.</li> <li>4. Connect external speakers and adjust the volume to a suitable level.</li> </ol>
Some picture elements do not light up	Some pixels of the display are off.	This display is designed using an extremely high level of precision technology: however, sometimes some pixels of the display may not display. This is not a malfunction..
After-Images can still be seen on the display after the display is powered off. (Examples of still pictures include logos, video games, computer images, and images displayed in 4:3 normal mode)	A still picture is displayed for an over extended period of time	Do not allow a still image to be displayed for an extended period of time as this can cause a permanent after-image to remain on the display.

<p>How to setup the settings in the menu to control all the monitors at the same time and individually via RC?</p>	<p>Daisy chained by RS232 and no IR cable</p>	<ol style="list-style-type: none"> <li>1. The first display sets as "Primary" on OSD (Advanced option/IR control item), others set as "Secondary".</li> <li>2. The setup OSD will show on top left side of the display.(Toggle MENU will show again if it disappear)</li> <li>3. Default setting: ID NO: 0, GP NO: 0, this setting can control all displays by IR. <ul style="list-style-type: none"> <li>The "+", "-" can change "ID NO" to control signal display by "Monitor ID".</li> <li>The "UP", "DOWN" can change "GP NO" to control multi-display by "Group ID".</li> </ul> </li> </ol> <p>*The first display is always controlled by IR.</p>
<p>How is the RC working?</p>	<p>Daisy chain: no connection of RS232 and IR cable</p>	<p>No setting is required. Connect with IR cables and control by IR.</p> <p>*This may cause out-of-synchronism phenomenon. It is suggested to use the above settings with RS-232 cable.</p>

### 13. Technical Specifications

#### Display:

Item	Specifications	
	43BDL3751T	55BDL3751T
Screen Size (Active Area)	108 cm / 42.5 inches	138.7 cm / 54.6 inches
Aspect Ratio	16:9	16:9
Number of pixels	3840 (H) x 2160 (V)	3840 (H) x 2160 (V)
Pixel pitch	0.2451(H) x 0.2451 (V) [mm]	0.315(H) x 0.315 (V) [mm]
Displayable colors	8 bits+FRC,1.07G colors	8 bits+FRC,1.07G colors
Brightness (typical)	420 cd/m <sup>2</sup>	410 cd/m <sup>2</sup>
Contrast ratio (typical)	1200:1	5000:1
Viewing angle	178 degrees	178 degrees

#### In/Out Terminals:

Item		Specifications
Speaker Output	Internal Speakers	10W (L) + 10W (R) [RMS]/8Ω 82 dB/W/M/160 Hz - 13 KHz
Audio Output	3.5mm phone jack x 1	0.5V [rms] (Normal) / 2 Channel (L+R)
RS232	2.5mm phone jack x 2	RS232 in / RS232 out
RJ-45	RJ-45 Jack x 1 (8 pin)	10/100/1000 LAN port
HDMI Input	HDMI Jack x 2 (Type A) (19 pin)	Digital RGB: TMDS (Video + Audio) MAX: Video - 720p, 1080p, 3840 x 2160/60 Hz Audio - 48 KHz/ 2 Channel (L+R) Supports LPCM only
IR Input/Output	3.5mm x 2	IR pass through
USB-B	USB-B x1	Connect touch function to external PC
USB Input	USB3.0 TypeA x2	USB 3.0, Multimedia play and service port
Displayport in	Displayport Jack x 1 (20 pin)	Digital RGB: TMDS (Video + Audio) MAX: Video - 720p, 1080p, 2160p Audio - 48 KHz / 2 Channel (L+R) Supports LPCM only
USB3.1 C	Type C : 15w	Power Delivery: 5V/3A
Expansion slot	USB 3.0 x 1	Reserve for CRD32
OTG	Micro USB	Support service and ADB data transmission



**General:**

Item	Specifications	
	43BDL3751T	55BDL3751T
Power Input	100 - 240V~, 50/60Hz	100 - 240V~, 50/60Hz
Power Consumption (Max)	145 W	179 W
Power Consumption (Typ.)	65 W	100 W
Power Consumption (Standby mode & Off mode)	<0.5 W	<0.5 W
AC Switch Off Mode (W)	0 W	0 W
WiFi+ Bluetooth Function	CRD32: Support WiFi 6 and Bluetooth V5.2	
Dimensions (Without Stand) [W x H x D]	990.0mm(W)x 578.2mm(H)x 103.9mm(D@EXTERNAL OPS BOX)/ 69.3mm(D@Wallmount)	1265.6mm(W)x 736.4mm(H) x 76.0mm(D@ OPS COVER)/ 69.8mm(D@Wallmount)
Weight (Without Stand)	17.05 Kg	24.96 Kg
Gross Weight (Without Stand)	20.63 Kg	32.18 Kg

**Environmental Condition:**

Item		Specifications
Temperature	Operational	0 - 40°C
	Storage	-20 - 60°C
Humidity	Operational	20 - 80% RH (No condensation)
	Storage	5 - 95% RH (No condensation)
Altitude	Operational	0 - 5,000 m
	Storage / Shipment	0 - 9,000 m

## Warranty Policy for Philips Professional Display Solutions

Thank you for purchasing this Philips product. Philips products are designed and manufactured with high standards and deliver high quality performance, ease of use and ease of installation. If you encounter any difficulties while using your product, we recommend that you first consult the user manual or the information in the support section of the website, where (depending on the product type) you may find a downloadable user manual, frequently asked questions, instruction videos or a support forum.

### LIMITED WARRANTY

In the unlikely event the product requires service, we will arrange for your Philips product to be serviced free-of-charge within the warranty period, provided that the product was used in accordance with the user manual (e.g. in the intended environment).

For these product categories, a partner company of Philips is the warrantor of the product. Please check the documentation supplied with your product.

### WHO IS COVERED?

Your Warranty coverage begins from the first date of purchase of the product. You need to provide proof of purchase to receive warranty service. A valid sales receipt or other valid document showing that you purchased the product is considered proof of purchase.

### WHAT IS COVERED?

If any defect due to faulty materials and/or workmanship occurs within the warranty period, we will make arrangements for a free of charge service. Where a repair is not possible or not commercially viable, we may replace the product with a new or equivalent refurbished product with similar functionality. Replacement will be offered at our discretion and the warranty will continue from the date of original purchase of the first date of purchase of the product. Please note that all parts, including repaired and replaced parts, are covered only for the duration of the original warranty period.

### WHAT IS EXCLUDED? Your warranty does not cover:

- Consequential damages (including but not limited to loss of data or loss of income), nor compensation for activities done by yourself, such as regular maintenance, installing firmware updates or saving or restoring data (Some states do not allow the exclusion of incidental or consequential damages, so the above exclusion may not apply to you. This includes, but is not limited to, prerecorded material, whether copyrighted or not copyrighted.)
- Labor charges for installation or setup of the product, adjustment of customer controls on the product, and installation or repair of various types of external devices (e.g., WiFi, antenna, USB dongles, OPS type devices) and other systems outside of the product.
- Reception problems caused by signal conditions or cable or antenna systems outside the unit.
- A product that requires modification or adaptation to enable it to operate in any country other than the country for which it was designed, manufactured, approved and/or authorized, or repair of products damaged by these modifications.
- If the model or production number on the product has been altered, deleted, removed or made illegible.

The warranty applies on condition that the product has been handled properly for its intended use and in accordance with the operating instructions

#### To Obtain Warranty Service And Information

For detailed warranty coverage information and additional support requirement and help line, please contact the seller and/or system integrator you purchased the product from. Please note in the USA, this limited warranty is only valid for Products purchased in the Continental United States, Alaska, and Hawaii.

#### Before Requesting Service

Please check your user's manual before requesting service. Adjustments of the controls discussed there may save you a service call.

#### WARRANTY PERIOD

Warranty period for PHILIPS signage display is listed as below, for areas not covered in this table, please follow their warranty statement.

Standard warranty period for PHILIPS signage display is listed as below, for areas not covered in this table, please follow the local warranty statement.

Region	Standard Warranty Period
USA, Canada	3 years
China	3 years
Japan	3 years
Rest of world	3 years
Mexico	3 years
Brazil	3 years
Chile	3 years
Peru	3 years

Note that for professional products, the specific warranty terms of the sale- or purchase agreement may apply.

# Index

## A

About 61  
Accessibility 60  
AC Switch Cover 24  
AC Switch Cover(Only for 43BDL3651T) 22  
Android Settings 69  
Apps 59

## B

Browser 33

## C

Change Picture Format 29  
Cleaning and Troubleshooting 74  
Connected devices 48  
Connecting a PC 24  
Connecting Audio Equipment 25  
Connecting External Equipment 24  
Connecting External Equipment (Multimedia Player) 24  
Connecting Multiple Displays in a Daisy-chain  
Configuration 25  
Control Panel 15  
Custom App 44

## D

Display 60  
Display Switch 45

## F

File manager 45  
File Manager 45

## H

Handling the remote control 17

## I

Input Mode 71  
Input/Output Terminals 16  
Inserting the batteries in the remote control 17  
Installation Notes 12  
IR connection 26  
IR Pass-through Connection 26

## K

Kiosk 39

## L

Launcher 29

## M

Media Player 30  
Mounting in Portrait Orientation 14

Mounting on a Wall 13

## N

Navigating the OSD Menu 63  
Network & internet 46

## O

Open frame kit 23  
Operating range of the remote control 17  
Operation 29  
OSD Menu 63  
OSD Menu Overview 63  
Overview 29

## P

Package Contents 12  
Parts and Functions 15  
PDF Player 37  
Pixel Defect Policy 72

## R

Remote Control 18

## S

Safety Instructions 1  
Security 60  
Setting UI 46  
Side Bar 44  
Signage Display 48  
Supported Media Formats 70  
System 60

## T

Technical Specifications 77  
Touch Operation 27

## U

Unpacking 10  
Unpacking and Installation 10

## W

Warranty policy for Philips Professional Display Solutions  
79  
Watch the Connected Video Source 29



2024 © TOP Victory Investments Ltd. All rights reserved.

This product has been manufactured by and is sold under the responsibility of Top Victory Investments Ltd., and Top Victory Investments Ltd. is the warrantor in relation to this product. Philips and the Philips Shield Emblem are registered trademarks of Koninklijke Philips N.V. and are used under license.

Specifications are subject to change without notice.  
Version: V1.00 2024-12-02