

FIG. 2

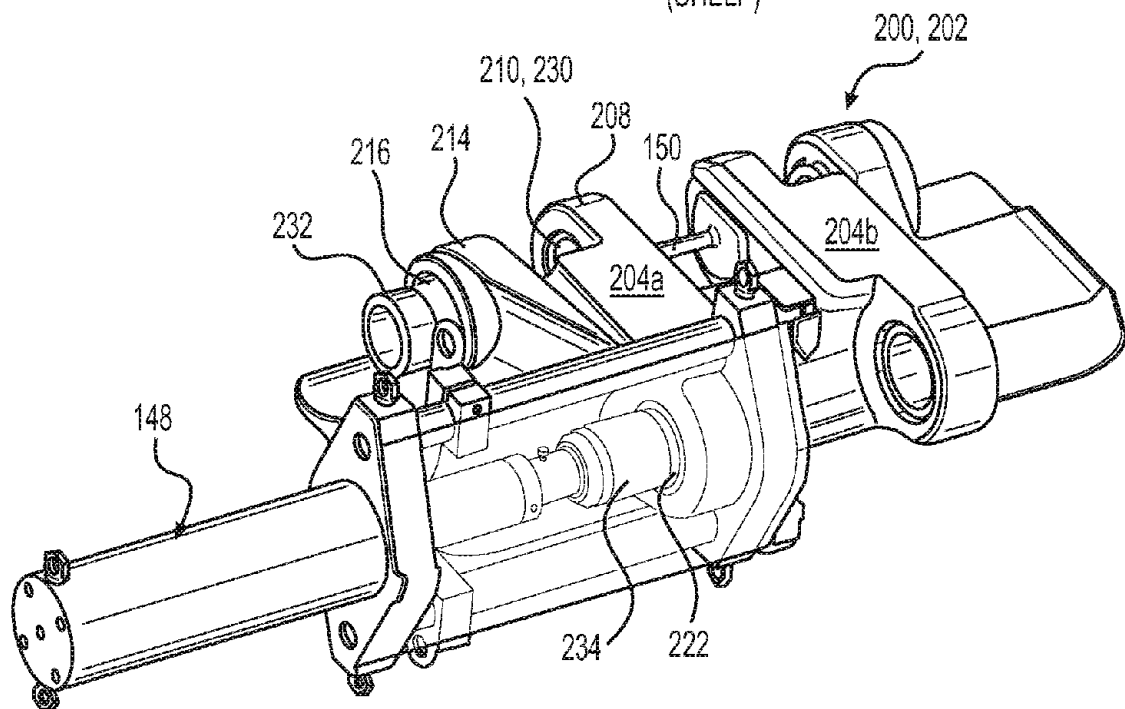

FIG. 3