

Product specifications

- 1/2" ceramic disc cartridge
 - 2 1/8" x 2 1/8" flange
 - 1 1/4" hole diameter
- [ADA]

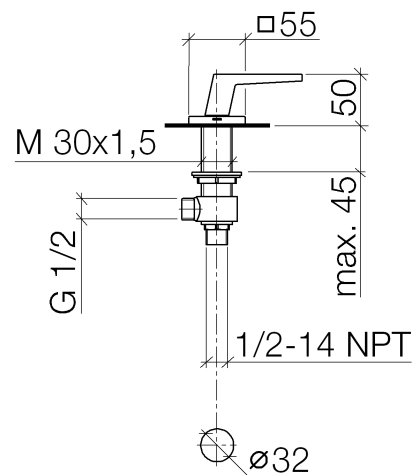

Surfaces

- | | |
|-------------|-------------|
| • chrome | 20000733-00 |
| • chrome | 20000733-00 |
| • champagne | 20000733-47 |
| • champagne | 20000733-47 |

Exploded assembly drawing

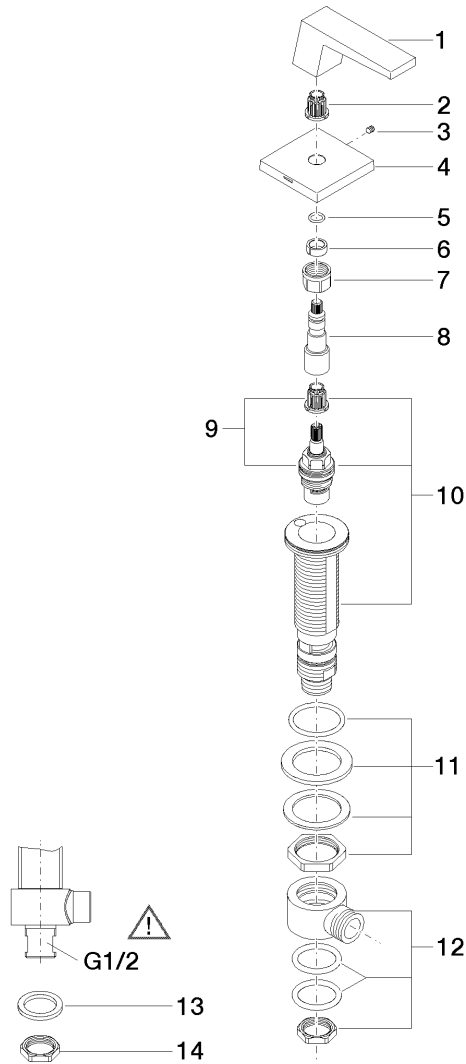

Order quantity

No.	Article number	Name	Installation quantity
1	092073201ff	handle	1
2	09121200290	fixing cap	1
3	09311100790	pin	1
4	092773002ff	rosette	1
5	09141006090	seal	1
6	09141502090	ring	1
7	09233002390	nut	1
8	092906107ff	spindle	1
9	9090031320090	top	1
10	0417110453290	side panel	1
11	0423100327890	fixing set	1
12	0417110231090	distributor	1
13	09301105990	disc	1
14	09231001290	nut	1

