

MODEL: 080824-1-FINISH
080824-3-FINISH

SPECIFICATION SHEET

MODULAR COLLECTION

- Soft Close Wood or Frosted Glass doors
- Soft Close and Full Extension drawers with Dovetail construction
- Undermount glides
- Matching finish throughout the interior
- Extend design with Optional 12", 15" & 18" Drawer Bank and 15" & 18" Linen Hutch
- Optional Drawer Organizer
- Matching Mirror, Medicine Cabinet, Overjohn Cabinet and Wall Cabinet

All Ronbow cabinets are made of solid hardwood or hardwood plywood and meet strict CARB Standards. No particle Board or Micro-Density Fiberboard (MDF) are used.

Available finishes:

DARK CHERRY H01

WHITE W01

Available fronts:

FROSTED GLASS DOORS

WOOD DOORS

Available tops:

CERAMIC SINKTOP

STONE COUNTER

TECHSTONE™ TOP

WIDEAPPEAL™ TOP

TOP VIEW

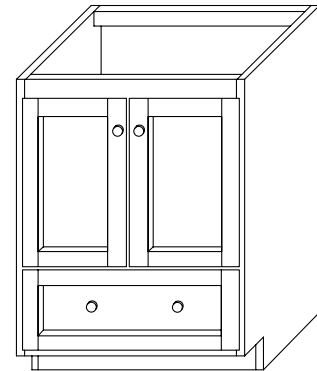
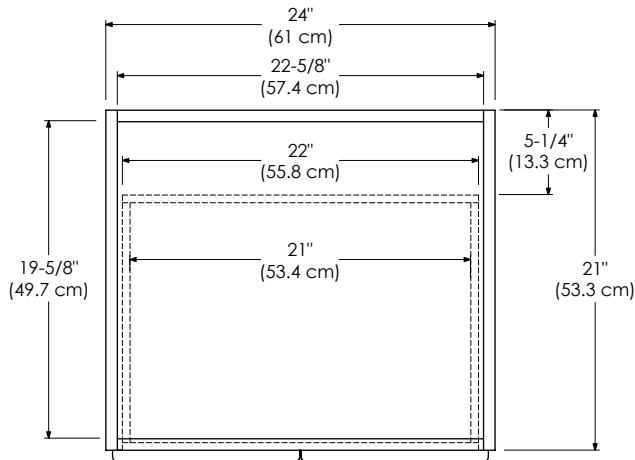

FRONT VIEW

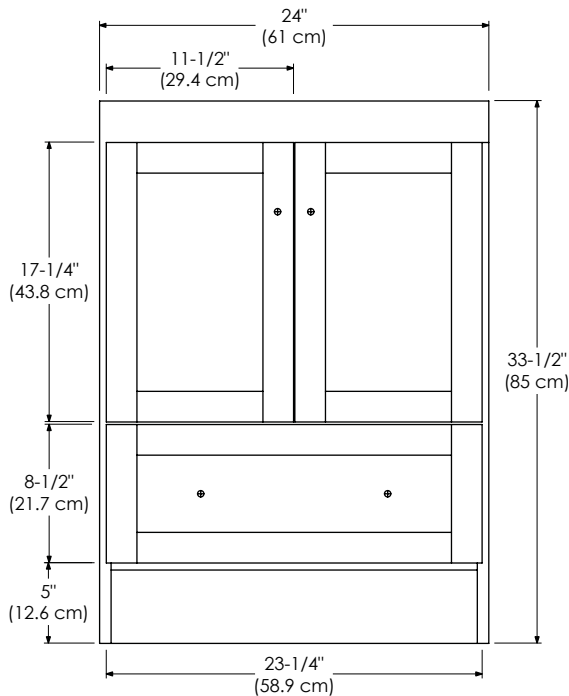

SIDE VIEW

