

MODEL: 010131-1-FINISH
010131-3-FINISH

SPECIFICATION SHEET

WALL-HUNG COLLECTION

- Optional Wood or Frosted Glass drawer front
- Soft Close and Full Extension drawers with Dovetail construction
- Undermount glides
- Matching finish throughout the interior
- Extend design with optional 12", 15" & 18" Drawer Bridge, 15" Shelf Bridge and 35" max Bridge Panel
- Optional Drawer Organizer
- Matching Mirror, Medicine Cabinet and Wall Cabinet

All Ronbow cabinets are made of solid hardwood or hardwood plywood and meet strict CARB Standards. No particle Board or Micro-Density Fiberboard (MDF) are used.

Available finishes:
DARK CHERRY H01
CINNAMON F08
BLACK B02

Available fronts:
FROSTED GLASS FRONT
WOOD FRONT

Available tops:
CERAMIC SINKTOP
GLASS SINKTOP
TECHSTONE™ TOP
WIDEAPPEAL™ TOP

TOP VIEW

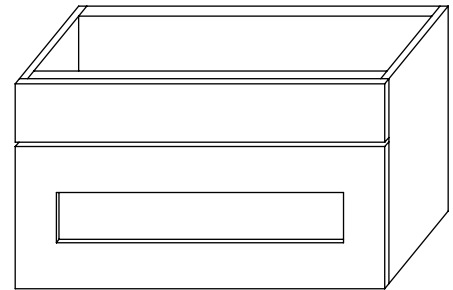
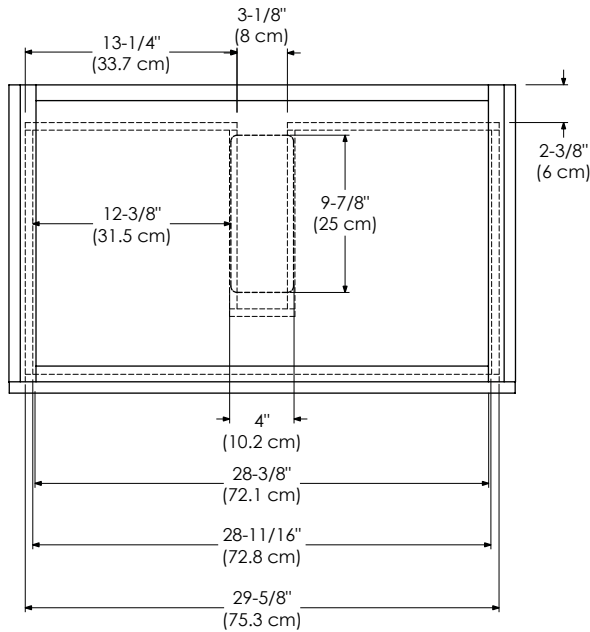

FRONT VIEW

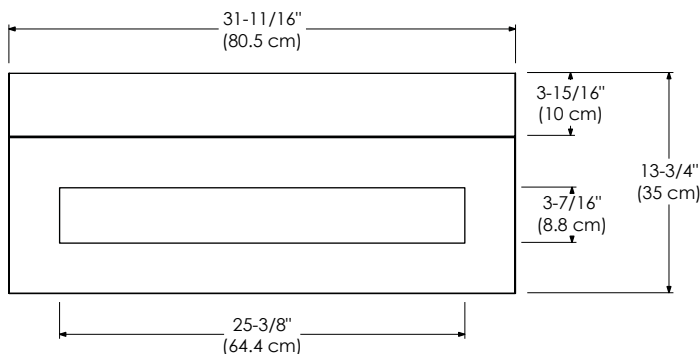

SIDE VIEW

