

All measurements in inches

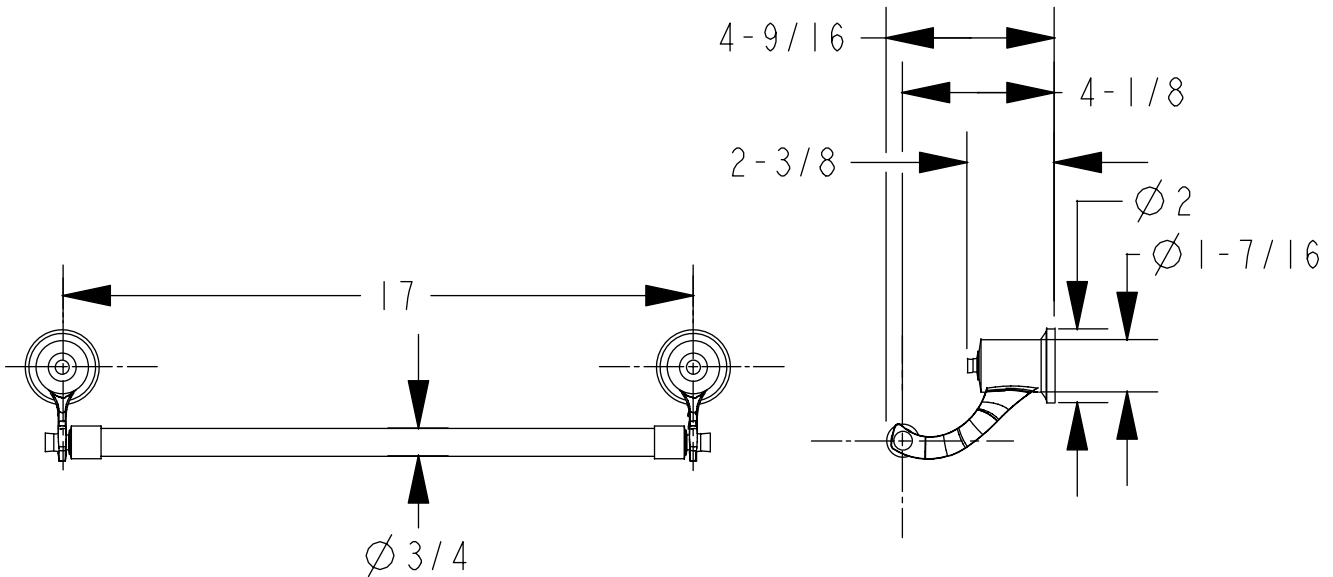

Image NOT to Scale

We reserve the right to make revisions without notice in the design of fixtures or in packaging unless this right has specifically been waived at the time the order is accepted.

This product meets ANSI/NSF Standard 61, Sect. 9, Safe Drinking Water Act - Lead Content and Leaching

MANUFACTURED :: CALIFORNIA, US (CNC) COMPUTER NUMERICAL CONTROL

MATERIAL :: SOLID BRASS

WEIGHT(LBS.) :: 4.05

FINISHES

- 008 - POLISHED COPPER LACQUERED
- 009 - POLISHED COPPER
- 010 - OIL RUBBED BRONZE
- 014 - ANTIQUE NICKEL LACQUERED
- 015 - POLISHED NICKEL
- 018 - BRUSHED NICKEL
- 026 - POLISHED CHROME
- 027 - MATTE CHROME
- 028 - BRUSHED CHROME

waterdecorTM

For technical assistance please call 877.222.9644 or fax 626.744.0377