



41180 Raintree Court
 Murrieta, CA 92562
 1-888-304-0660
 www.waterstoneco.com

ITEM NO: **4410-18**

STYLE: **GANTRY®**

INTENDED USE: TRADITIONAL
 KITCHEN FAUCET / PRE-RINSE

CUSTOMER NAME:

JOB NO:

DIMENSIONS MAY VARY AND ARE SUBJECT TO CHANGE. NO RESPONSIBILITY IS ASSUMED FOR USE OF SUPERCEDED OR VOIDED DATA

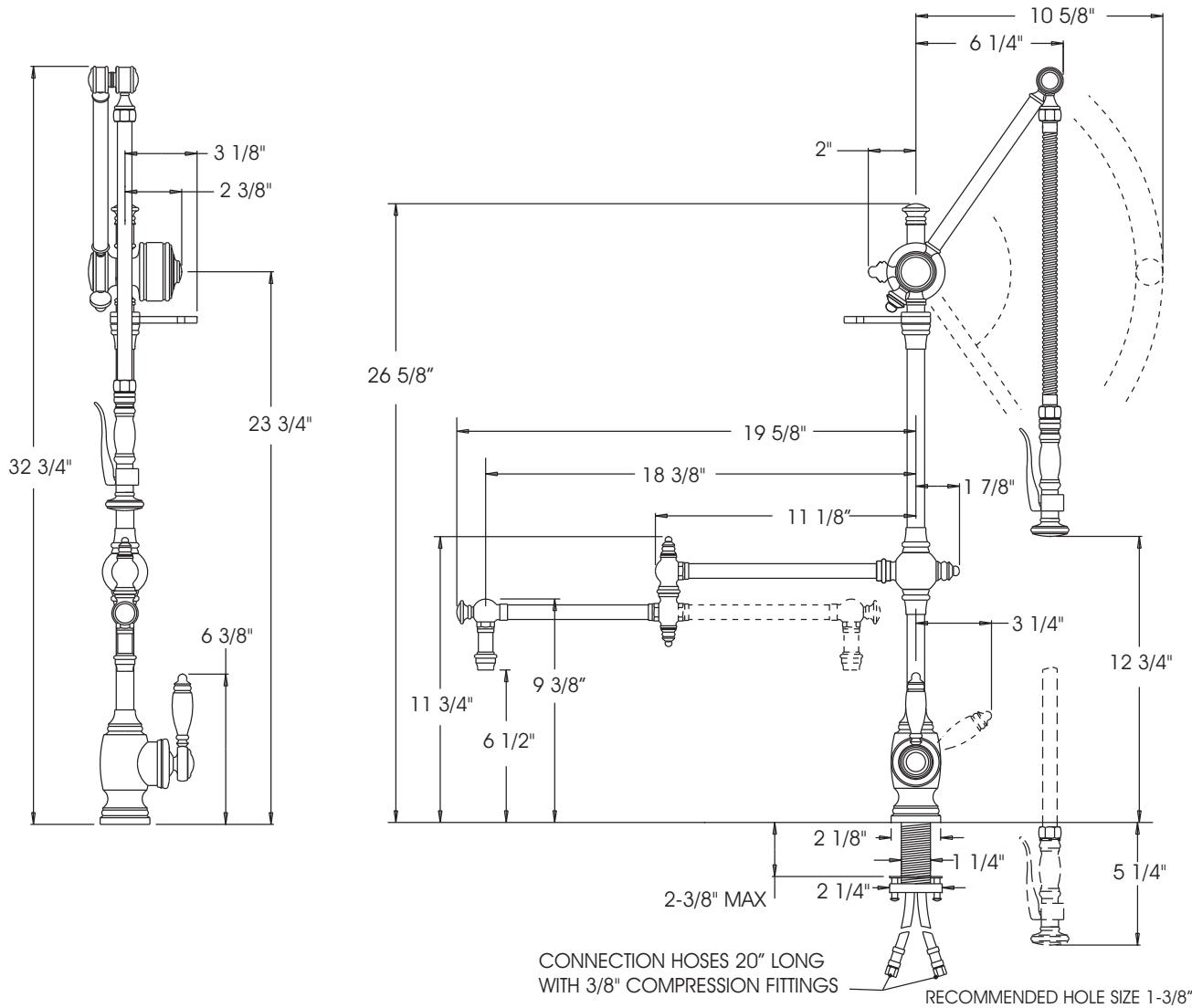

Technical Specifications

- Solid Brass construction.
- Single lever control hot/cold ceramic disk valve cartridge.
- 360 degree swivel spout
- Aerated stream
- 3 handle caps included. Plain, and ceramic right hand or left hand operation indicated for hot and cold.
- 1.75 gpm maximum flow rate.
- Lever operated diverted spray
- Reinforced braided connection hoses.
- Adjustable PTFE "Friction Lock" aids handle feel and prevents sag.
- Handle adjusts 45 degrees in either direction for clearance from backsplash.
- Patent protected design.

Codes/Standards Applicable

Specified model meets or exceeds the following:

- ASME A112.18.1
- CSA B125.1
- NSF 61
- CALGreen

DATE: 12-19-12



MADE IN THE USA