

JACOBEEAN

Widespread Lavatory Faucet 2470

Features

- Solid brass construction
- Brass valve bodies
- Quarter-turn washerless ceramic disc valve cartridges
- ADA compliant handles
- Spout assembly with integral supply hoses
- Pop-up drain with tailpiece
- 4-3/16" (10.6 cm) spout height at outlet
- 6-1/8" (15.6 cm) spout reach (c-c)
- For 8" (20.3 cm) centers - Maximum 20" (50.8 cm)
- 1.5 gallons (5.7 liters) per minute maximum flow rate

Codes / Standards Compliance

Meets or exceeds the following at date of manufacture:

- ASME A112.18.1/CSA B125.1
- IAPMO/UPC
- IPC
- NSF 61
- ADA
- ICC/ANSI A117.1
- Energy Policy Act of 1992
- All applicable US Federal and State material regulations
- EPA WaterSense®

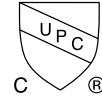

Colors / Finishes

- 10B: Oil Rubbed Bronze
- 15: Polished Nickel
- 15S: Satin Nickel
- 26: Polished Chrome
- Other: Refer to the Newport Brass catalog for additional color/finish options.

Specified Model

Model	Description	Colors / Finishes
2470	Widespread Lavatory Faucet	<input type="checkbox"/> 10B <input type="checkbox"/> 15 <input type="checkbox"/> 15S <input type="checkbox"/> 26 <input type="checkbox"/> Other

Product Specification:

Add "Color / Finish" suffix to Model number, below.

The two-handle Widespread Lavatory Faucet shall be made of solid brass construction. Faucet shall feature brass valve bodies. Faucets shall feature quarter-turn washerless ceramic disc valve cartridges. Faucet shall have a 1.5 gallon (5.7 L) per minute maximum flow rate. Product shall be for 8" centers (20.3 cm) - Maximum 20" (50.8 cm). Product shall have a 4-3/16" (10.6 cm) spout height at outlet, 6-1/8" (15.6 cm) spout reach (c-c), include a pop-up drain with tailpiece and ADA compliant handles. Faucet shall be Newport Brass Model 2470/_____.

Product Dimensions (units are in inches)

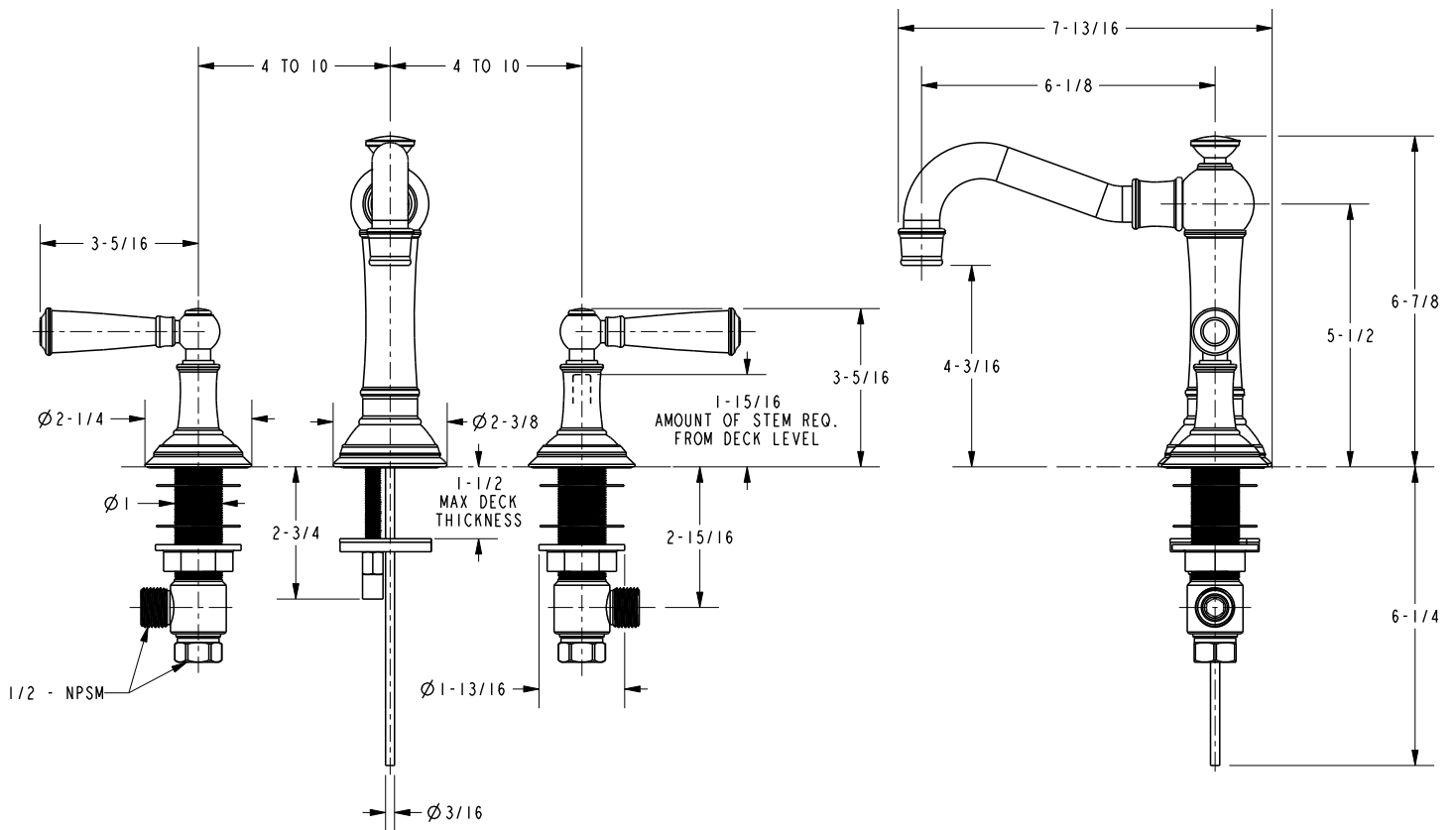

**Jacobean Widespread Lavatory Faucet
2470**