

**FEATURES:**

- All brass construction with glass shelf.
- Replacement glass shelf P/N: 18.18.024
- Available in all Sigma finishes. Warranty varies according to finish selection.
- Mounting bracket and screws are supplied.

Series 22  
Accessory Shelf

1.22AS00

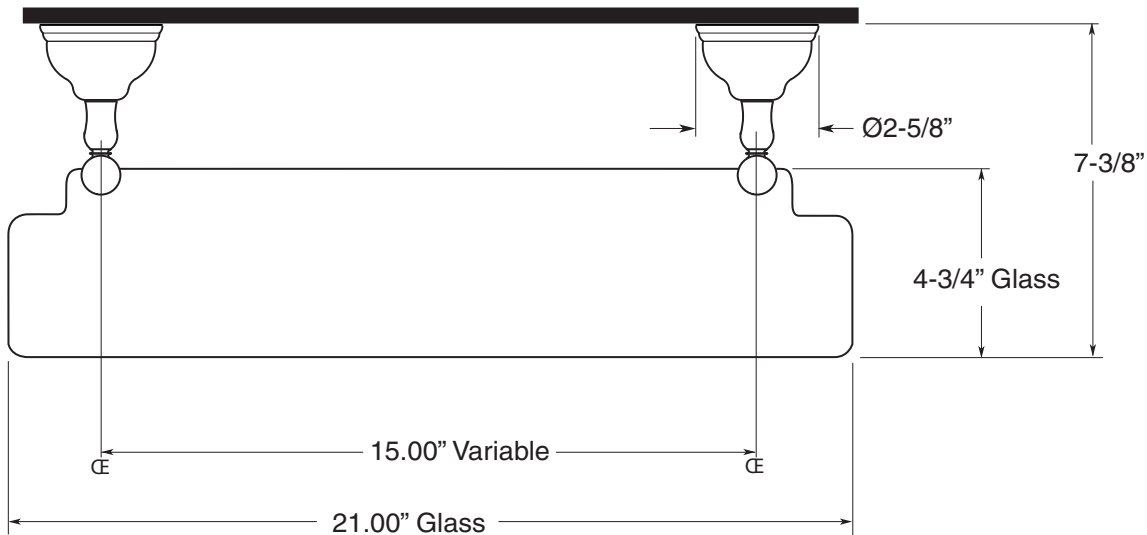

**TOP VIEW**

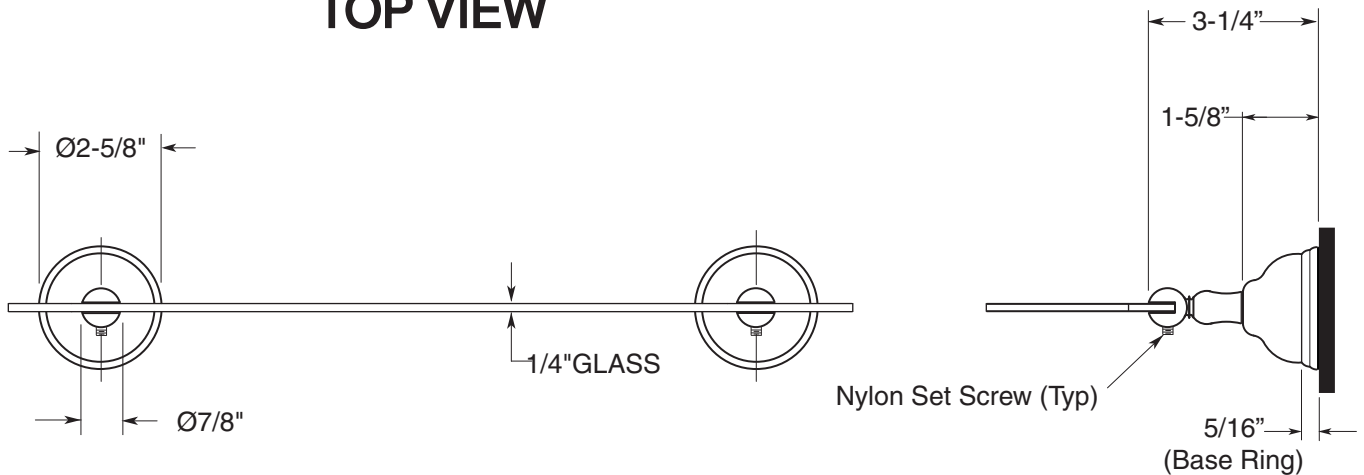

**FRONT VIEW**

**SIDE VIEW**

Note: Measurements are subject to change or cancellation. No responsibility is assumed for use of superseded or voided pages.