

ELKAY® SPECIFICATIONS

Celebrity® Hospitality Sink and Sink Package Models BCR15 and BCRA150C

GENERAL

Good quality sink bowl is seamlessly formed of #20 gauge, type 304 (18-8) nickel bearing stainless steel. Self-rimming.

DESIGN FEATURES

Bowl Depth: 6-1/8".

Coved Corners: 2-1/4" vertical and horizontal radius.

Bowl and Faucet Deck Recess: 3/16" total recess below outside edge of sink.

Finish: Exposed surfaces are machine polished to a highlighted bright finish.

Underside: Fully undercoated to dampen sound and prevent condensation.

SINK PACKAGE

BCRA150C Package includes:

- (1) **BCR15** sink.
- (1) **LKA2475** gooseneck faucet. Overall height 7-9/16".
- (1) **LK58** drain with basket strainer.

OTHER

Drain opening: 2".

NOTE: Unless otherwise specified, sink is furnished with 2 faucet holes as shown.

Complies with ANSI Standard A112.19.3.



This sink is listed by the International Association of Plumbing and Mechanical Officials as meeting the requirements of the Uniform Plumbing Code.



This sink is listed with the Canadian Standards Association.



This faucet is classified by Underwriters Laboratories Inc. to **NSF/ANSI61** for residential use.

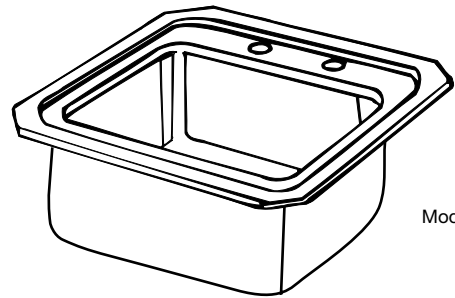

Model BCR15

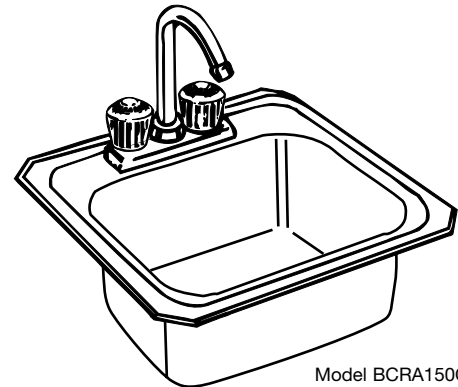

Model BCRA150C

SINK DIMENSIONS (INCHES)*

Model Number	Overall		Inside Bowl			Cutout in Countertop (1 1/2" Radius Corners)		No. of 1/4" or 1/2" Dia. Faucet Holes 4" Center	Minimum Cabinet Size
	L	W	L	W	D	L	W		
BCRA150C	15	15	12	10	6 1/8	14 3/8	14 3/8	2	18
BCR15	15	15	12	10	6 1/8	14 3/8	14 3/8	1, 2, MR2 or 3	18

*Length is left to right. Width is front to back.

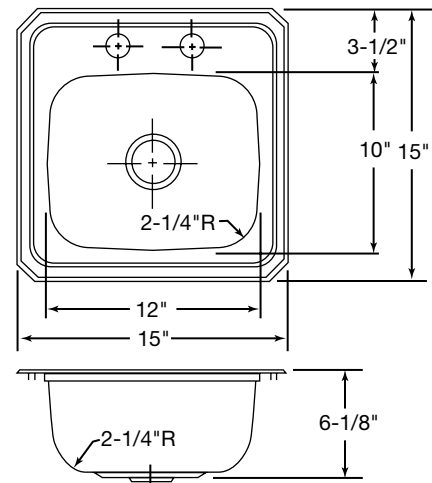

Model BCR152 Illustrated

HOLE DRILLING CONFIGURATIONS

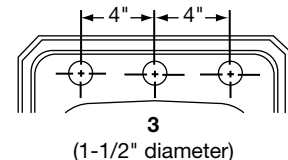
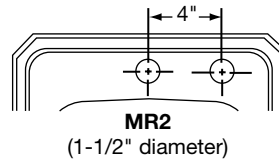
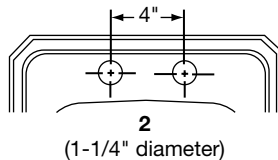
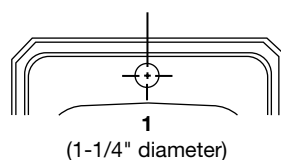

ALL DIMENSIONS IN INCHES, TO CONVERT TO MILLIMETERS MULTIPLY BY 25.4.

In keeping with our policy of continuing product improvement, Elkay reserves the right to change product specifications without notice.

This specification describes an Elkay product with design, quality and functional benefits to the user. When making a comparison of other producers' offerings, be certain these features are not overlooked.