

SPECIFICATION SHEET

PRODUCT FAMILY: **Sinks** FINISH: **Stainless Steel** SERIES: **PEAK** MODEL: **PKX11028**

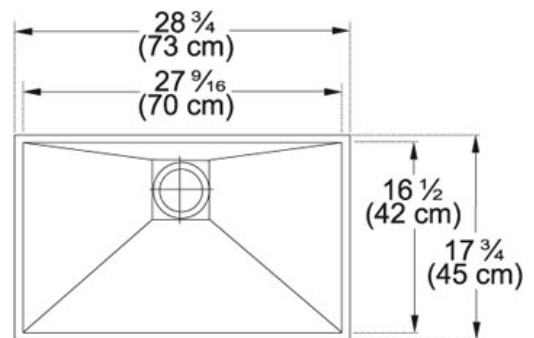

Product Information

FUN#	122.0074.954
US Part Number	PKX11028
Franke Integral Ledge	built-in
Minimum Cabinet Size	33"
Drain Opening	3 1/2"
Outer Dimensions	28 3/4"x17 3/4"
Bowl Size	27 9/16"x16 1/2"x9 7/8"
Number of Bowls	1
Type of Material	Stainless Steel

Accessories



112.0039.150



112.0066.060



112.0079.835

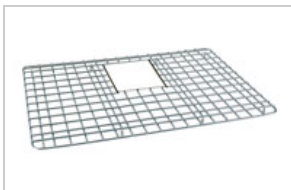

112.0173.263



112.0173.264

Suggested Products



112.0006.026



112.0066.071



112.0073.921



112.0073.934



119.0066.616



133.0178.205