

FEATURES:

This product meets and exceeds the following codes and standards

- Meets: ASME A112.18.1-2005/CSAB125.1-2005
- Replacement Cartridge: No. 18.30.011

3/4" In-Line Shut-Off

Valve & Trim

1.002284

Verona Handle

(1.002284T - Trim Only)

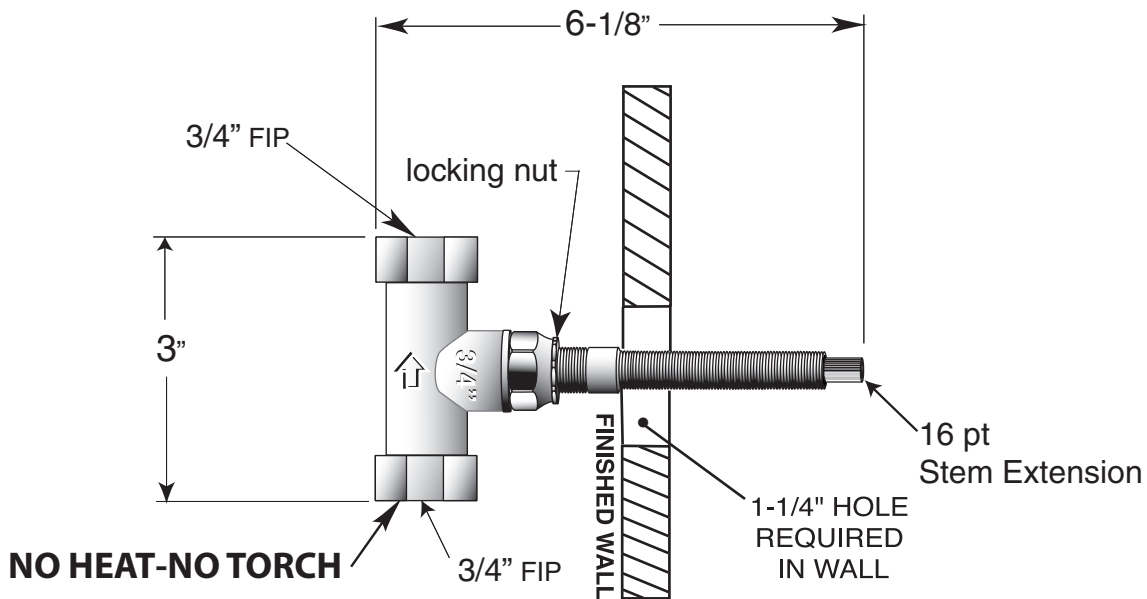
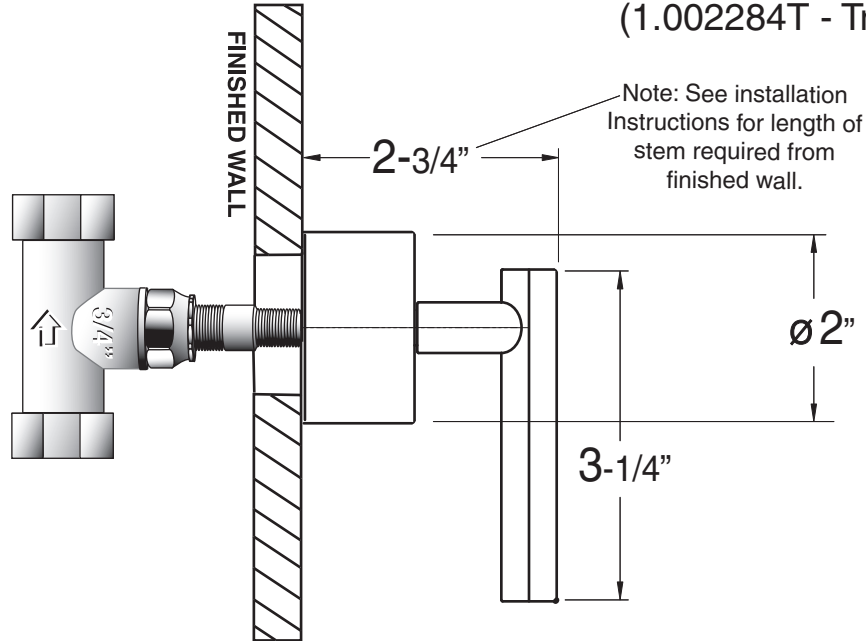

Note: Measurements are subject to change or cancellation. No responsibility is assumed for use of superseded or voided pages.