

FEATURES:

- All brass construction.
- Replacement glass shelf P/N: 18.18.024
- Available in all Sigma finishes. Warranty varies according to finish selection.
- Mounting bracket and screws are supplied.

Series 09
 Accessory Shelf

1.09AS00

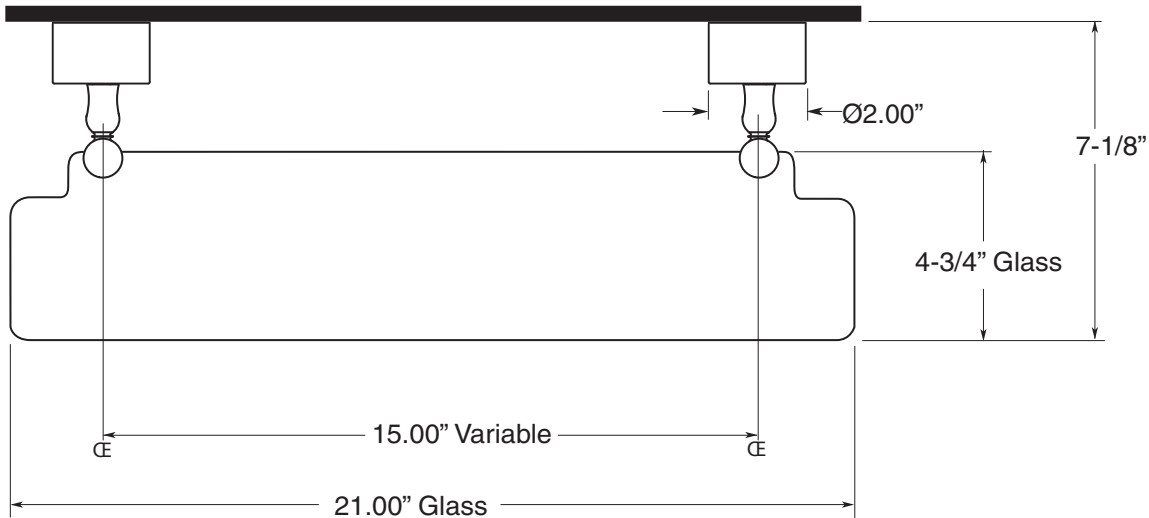

TOP VIEW

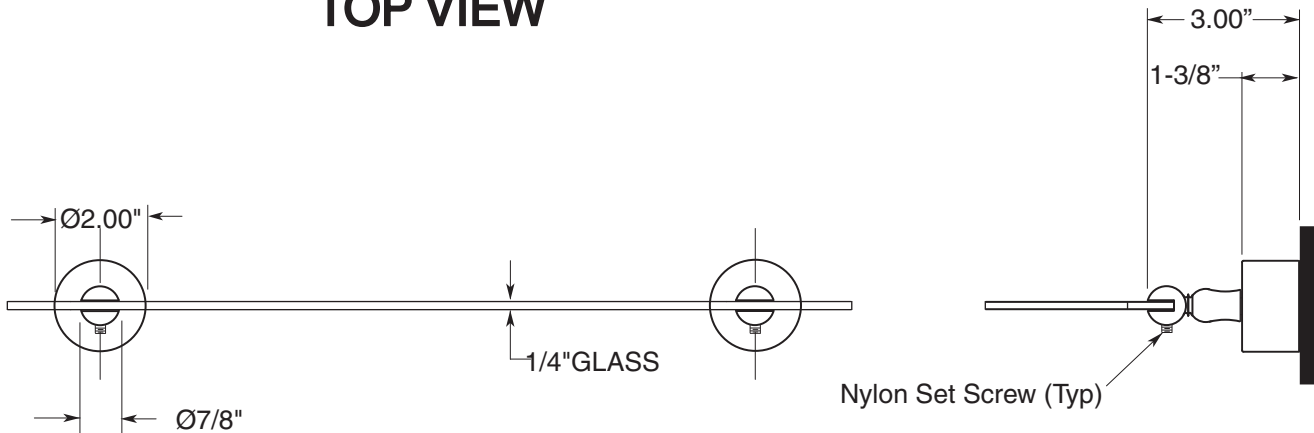

FRONT VIEW

SIDE VIEW

Note: Measurements are subject to change or cancellation. No responsibility is assumed for use of superseded or voided pages.