

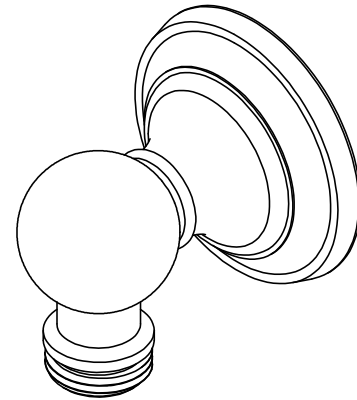

Features

- Over 30 finishes including 14 PVD finishes
- Solid brass construction
- 1/2" NPT (female) inlet connection
- 1/2" NPSM (male) outlet connection

SH-10-48



Codes/Standards Applicable

Meets or exceeds the following at date of manufacture:

- ASME A112.18.1/CSA B125.1

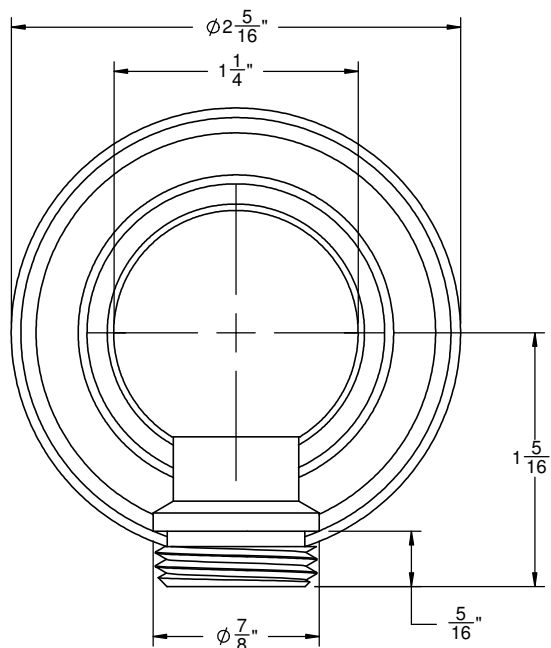
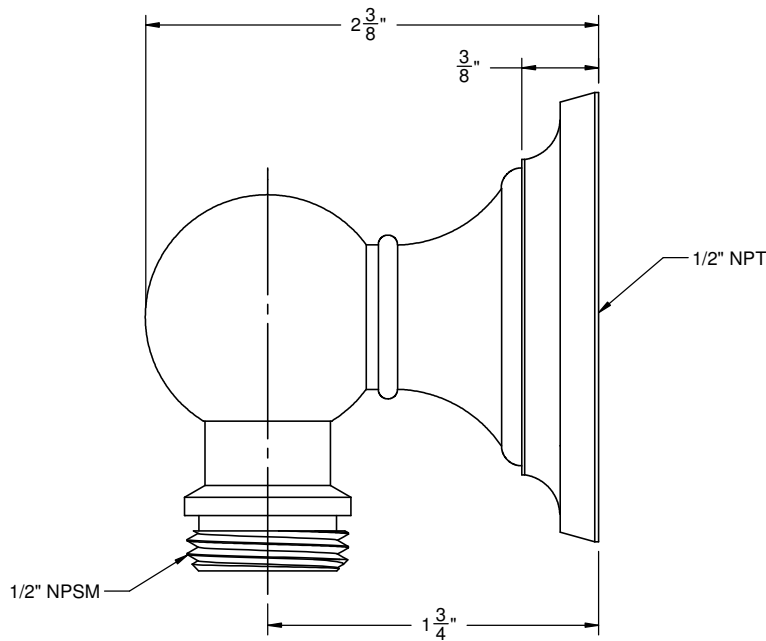

ALL DIMENSIONS SHOWN TO NEAREST 1/16"