

FRACTAL BASE UNIT 900mm. (36") / ARMAZON 900mm. SUSPENDIDO

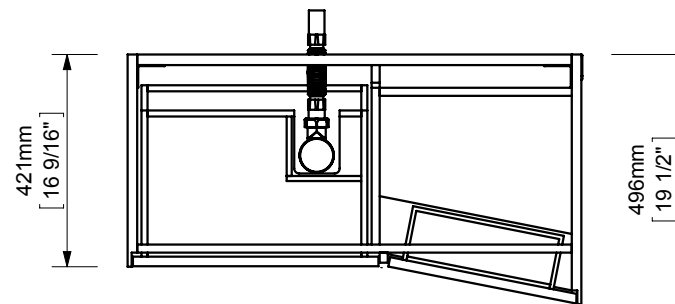
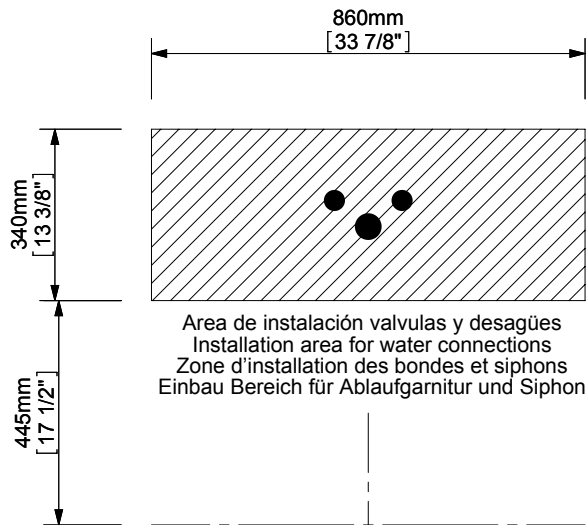
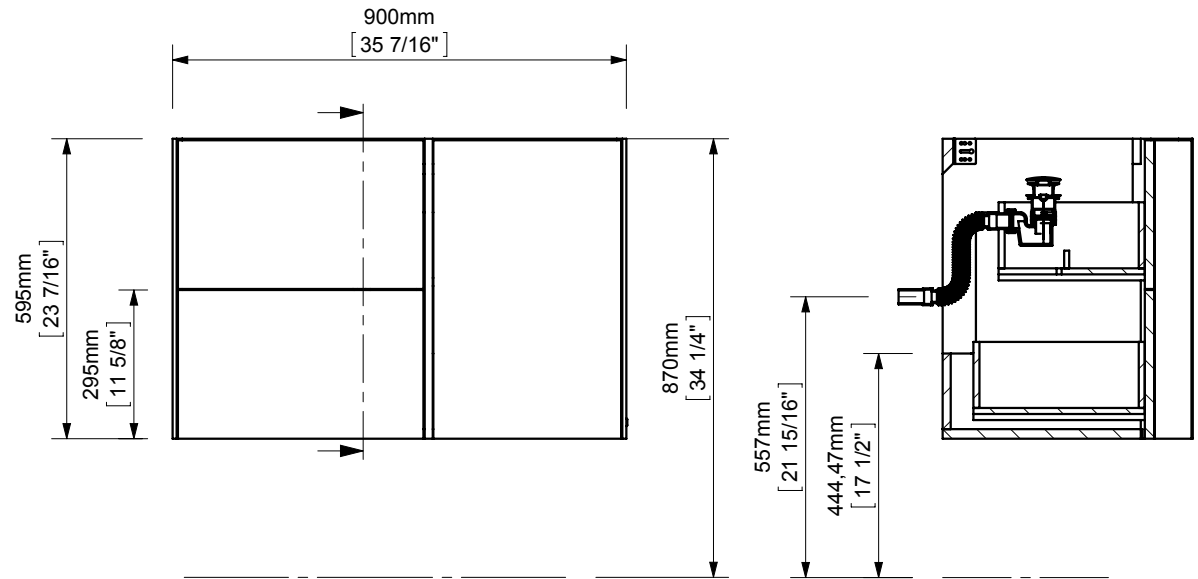
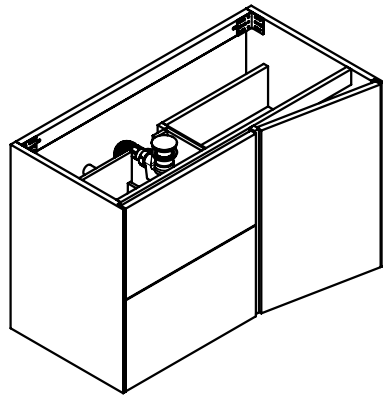

espec_209

Imágenes no a escala / Draw not to scale / Echelle non respectée

Peso / Weight / Poids: 45 Kg.

Acabados / Finish / Finitions: Según tarifa vigente / As per valid pricelist / Selon le tarif en vigueur

Normas / Regulations / Normes: UNE 56865, UNE 56866, UNE 56867, UNE 56868, UNE EN14749, UNE EN314-2

Sonia S.A se reserva el derecho de realizar cualquier cambio sin previo aviso
Sonia S.A has the right to make changes without notice
Sonia S.A se réserve le droit de procéder à tout changement sans notification préalable



www.sonia-sa.com