

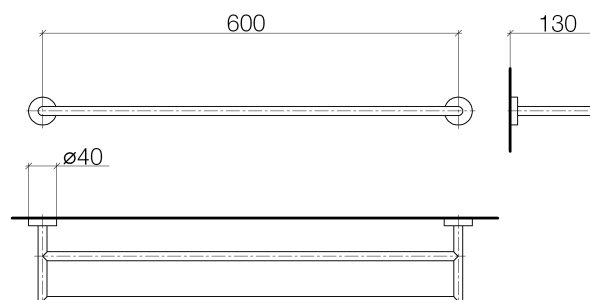

Product specifications

- Center to center 23 5/8"
- Flange diameter 1 5/8"
- 5 1/8" projection



Surfaces

- | | |
|-----------------|-------------|
| • chrome | 83061979-00 |
| • chrome | 83061979-00 |
| • matt platinum | 83061979-06 |
| • matt platinum | 83061979-06 |

Exploded assembly drawing

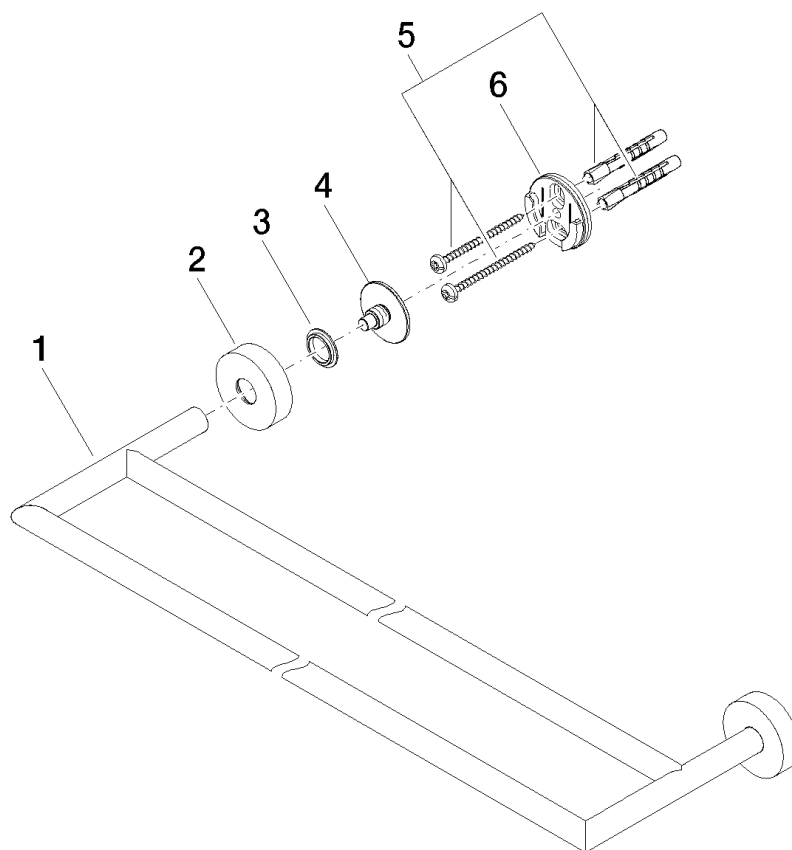

Order quantity

No.	Article number	Name	Installation quantity
1	05282262201ff	holder	1
2	082797500ff	rosette	2
3	08301151690	ring	2
4	08179756090	holder	2
5	0530310250090	fixing set	1
6	08179750107	holder	2