





Lacey 6030 with 17" Deck

For Options, check the Lacey family spec sheet



Must be set in Mortar Base

-  Pump motor
-  Jets
-  Anti-vortex suction
-  Overflow location

AS SHOWN:
Whirlpool option w/ standard jets

ALSO AVAILABLE:
Soaking Tub Only, Thermal Air, Combo

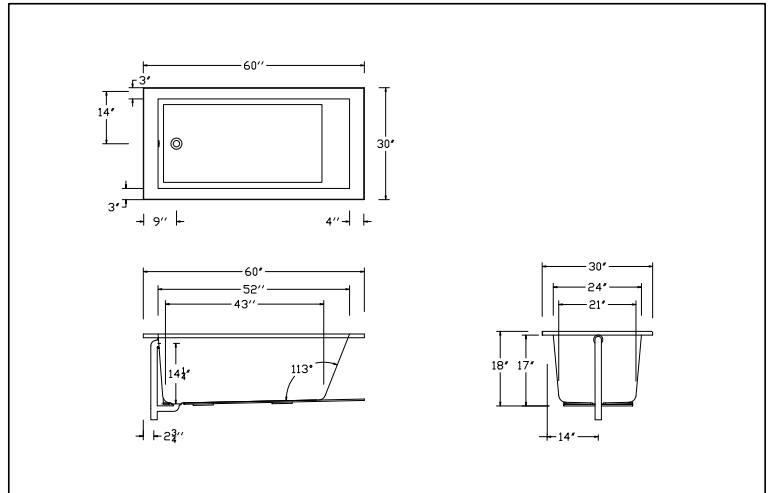

HYDRO SYSTEMS, INC.
29132 Avenue Paine, Valencia, CA 91355
661.775.0686, fax 661.775.0668, www.hydrosystem.com

Note: The information contained on this drawing is the sole property of Hydro Systems, Inc. Any reproduction in part or as a whole without the written permission of Hydro Systems, Inc. is prohibited.

Title: Lacey 6030 - 17" Deck	
Date: August 9, 2011	Rev: 0
Scale: None	Date:
Material: Acrylic and Fiberglass, 1/2" nominal thickness	

Model	GC	AC	A	B	C	D	E	F	G	H	I	J	K	L	M	Jet	Pump	Wat.Cap.
6030-17	N/A		60"	30"	9"	14"	4"	3"	41"	18"	52"	18"	1 1/4"	2 3/4"	N/A	6	2.25	47 gal.
Amps	Volts	Breaker	Dedicated Service															
13.5	120	20 amp	GFCI Protected															

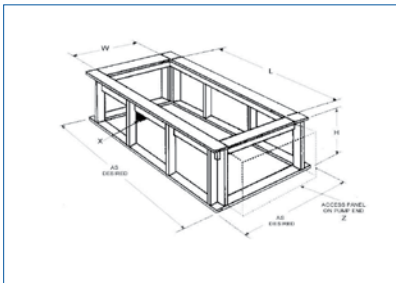

Disclaimer: Certain options or altering the pump/blower location may cause the pump/blower to extend beyond the tub decking. For cutout dimensions wait for unit to arrive. All specifications subject to change without notice.

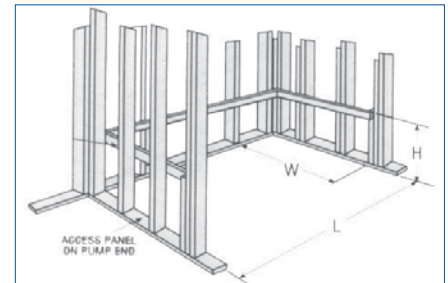

Island Drop-In				3 Wall Installation		
Model	(L)ength	(W)idth	(H)eighth Finish	(L)ength	(W)idth	(H)eighth Ledger Molded
6030-17	58"	28"	18"	60"	30"	18 3/4"

HYDRO SYSTEMS, INC.
29132 Avenue Paine, Valencia, CA 91355
661.775.0686, fax 661.775.0668, www.hydrosystem.com

Model: **Lacey 6030 w/17" Deck**
Scale: None
Material: Acrylic & Fiberglass