



Cube

BC 09 - no apron

inch 60x30x24 mm 1524x762x610

interior dimensions

rim: inch 52x24 mm 1321x610
 base: inch 42x23 mm 1067x584
 height: inch 20 mm 508

capacity to overflow

gal (us) - 67 liters - 254

weight

lb - 198 kg - 90

installation

drop-in bathtub (BC 0901)
 1 wall, 2 walls or 3 walls

accessory

oak bridge wenge shade

material

WETMAR BIO™, True High Gloss™
 or matte finish

color

white

codes/standards applicable

IAPMO-ANSI Z124.1
 IAPMO-ANSI Z124.3
 CSA B 45.0 - CSA B45.4

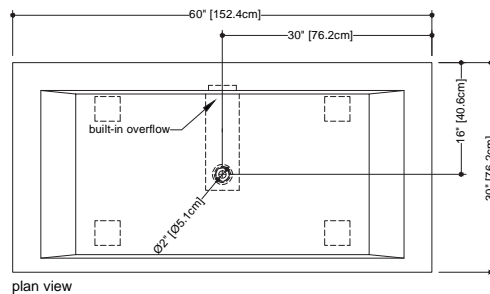
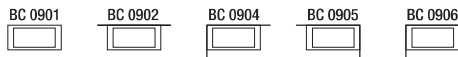

plan view

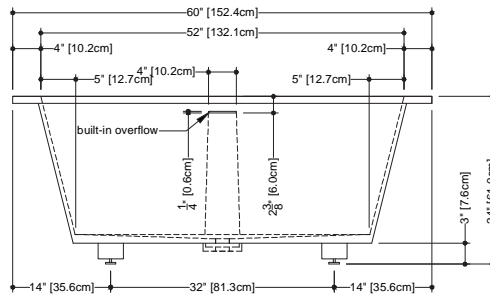

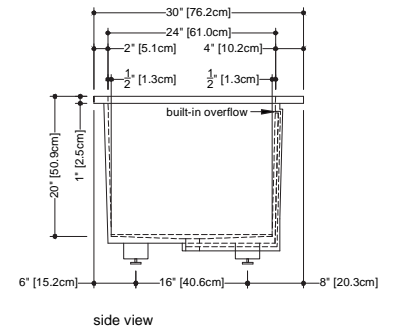

front view



side view



WETSTYLE Plug & Bathe™ overflow and drain connection system includes:

-  Soft-touch pop-up drain, for built-in overflow. Fits both 1-1/2" ABS drain waste and 1-1/2" tubular brass
-  1-1/2" ABS Direct vertical drain waste fitting (copper/brass option also available)
-  1-1/2" ABS 90° Elbow drain waste fitting (copper/brass option also available)

WETSTYLE cannot be held responsible for any technical errors and reserves the right to make revisions without notice.

Approximate measurement.
 The manufacturer accept 1/8" (6.35mm) variance.

www.WETSTYLE.CA - Montreal - Canada
 Tel. 450.536.9000 - 1 888.536.9001 - Fax. 450.536.0202





Cube

BC 09 - no apron

inch 60x30x24 mm 1524x762x610

■ **overflow and drain connection**
WETSTYLE Plug & Bathe™ system
(ABS or copper/brass)

■ **overflow**
slot design
polished chrome or brushed nickel

■ **drain**
soft toe touch
polished chrome or brushed nickel

■ **waste and overflow kit**
included

■ **faucet area recommended**
bath deck
or floor-mounted

■ **trap access**
white access panel

wide-deck bathtub;
wall shower installation
is not recommended

* Due to multiple possibilities,
faucet holes must be drilled by the plumber.

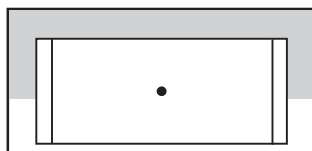

■ Faucet installation zone

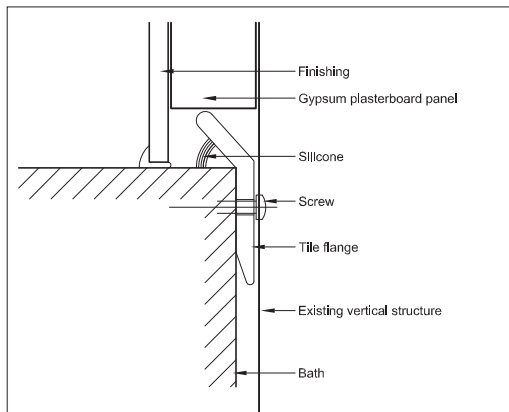

side view

Tile flange - detail

Bathtub installation supplies

A tile flange will be supplied to comply with the requested position. Installed at the factory to prevent water leakage, this must be placed directly on the partition framing prior to the installation of drywall.

WETSTYLE cannot be held responsible for any technical errors and reserves the right to make revisions without notice.

Approximate measurement.
The manufacturer accept 1/4" (6.35mm) variance.

www.WETSTYLE.CA - Montreal - Canada
Tel. 450.536.9000 - 1 888.536.9001 - Fax. 450.536.0202

