

**FEATURES:**

- All brass construction.
- Glass tumbler P/N: 18.18.023.
- Available in all Sigma finishes. Warranty varies according to finish selection.
- Mounting bracket and screws are supplied.

Series 07  
Tumbler Holder  
1.07TH00

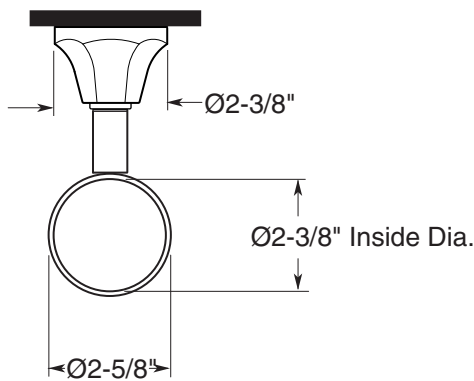

**TOP VIEW**

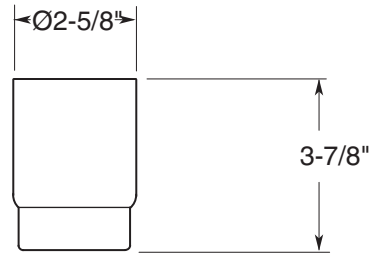

**GLASS TUMBLER**

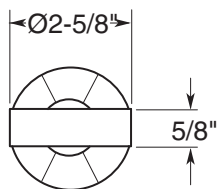

**FRONT VIEW**

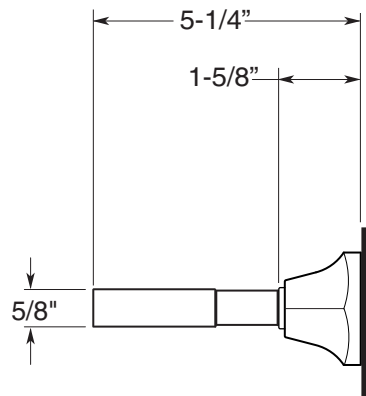

**SIDE VIEW**

Note: Measurements are subject to change or cancellation. No responsibility is assumed for use of superseded or voided pages.