

TECHNICAL SPECIFICATIONS

FEATURES:

- Solid brass construction
- High quality finishing
- 5 3/4" spout C to C
- Mechanical drain
- 2GPM water conservation aerator
- CSA approved

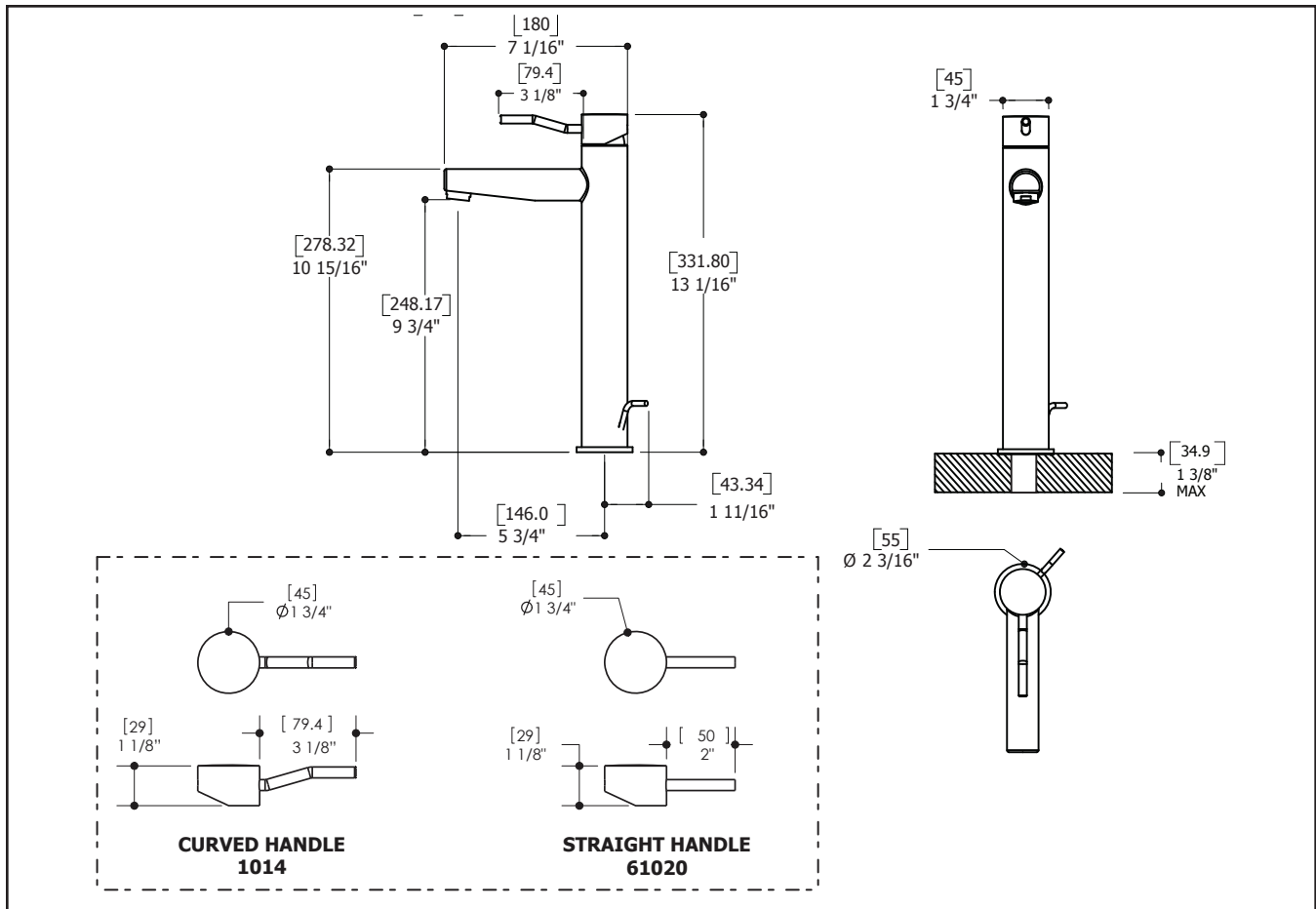
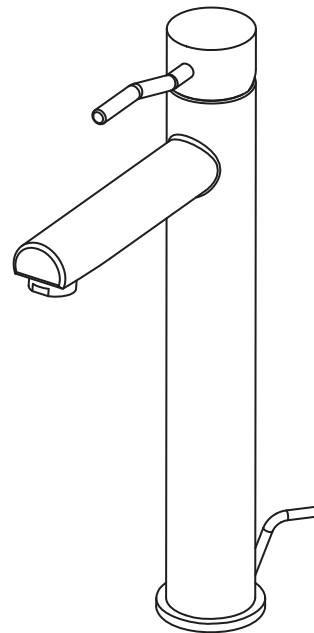

SERVICE PARTS

