

FEATURES:

- All brass construction.
- Glass tumbler P/N: 18.18.023.
- Available in all Sigma finishes. Warranty varies according to finish selection.
- Mounting bracket and screws are supplied.

Series 44
Tumbler Holder
1.44TH00

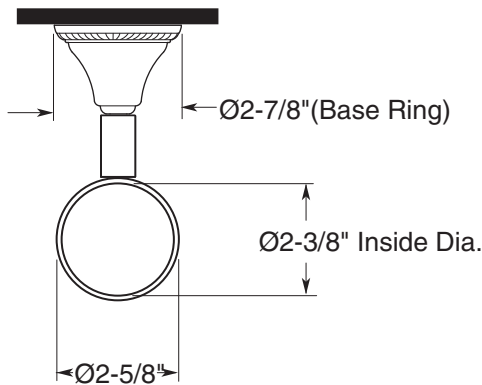

TOP VIEW

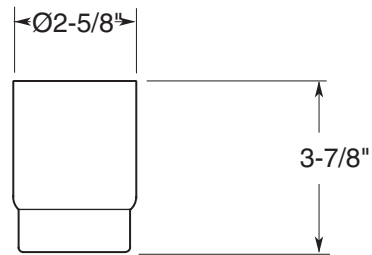

GLASS TUMBLER

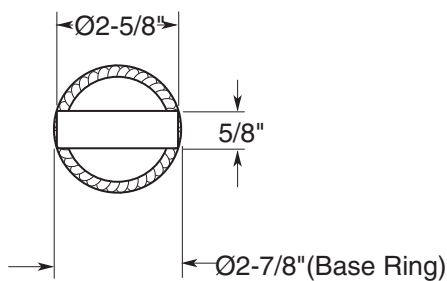

FRONT VIEW

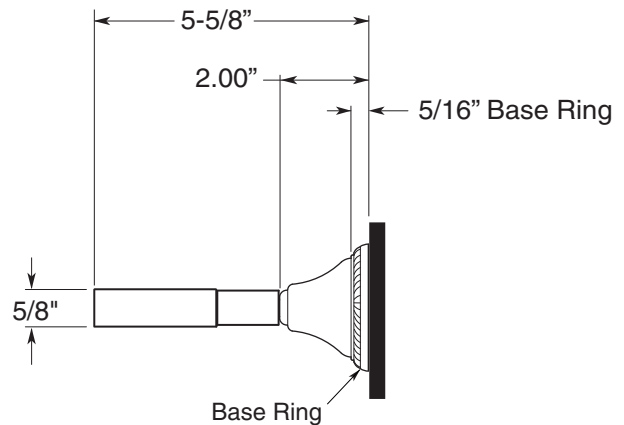

SIDE VIEW

Note: Measurements are subject to change or cancellation. No responsibility is assumed for use of superseded or voided pages.