

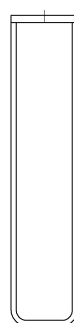

Product specifications

- Width 3 1/2"
- 16 1/2" projection

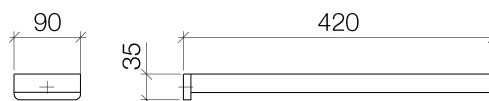

Surfaces

- | | |
|-----------------|-------------|
| • chrome | 83210710-00 |
| • chrome | 83210710-00 |
| • matt platinum | 83210710-06 |
| • matt platinum | 83210710-06 |

Exploded assembly drawing

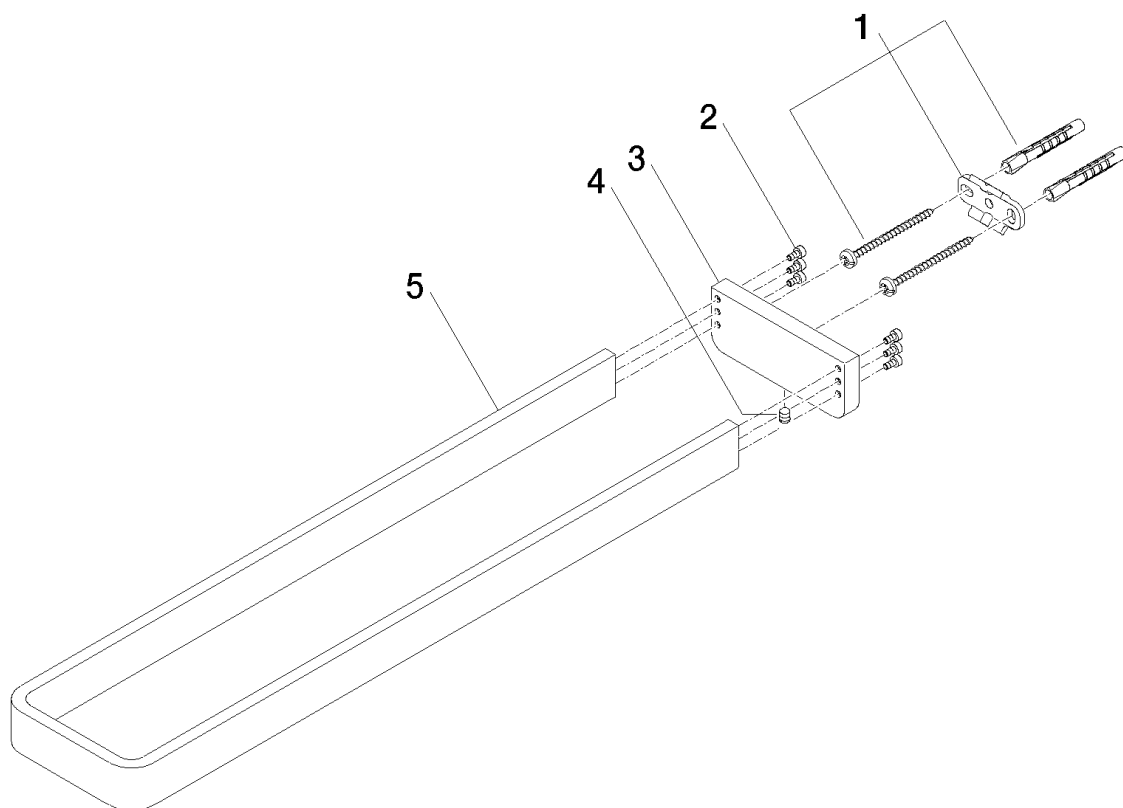



Order quantity

No.	Article number	Name	Installation quantity
1	0517207170090	fixing set	1
2	9030300590090	screw	2
3	081771503ff	holder	1
4	09311111290	pin	1
5	081771553ff	holder	1