

000171 | **Classic™**

Project name: _____

Specifier: _____ Contractor: _____

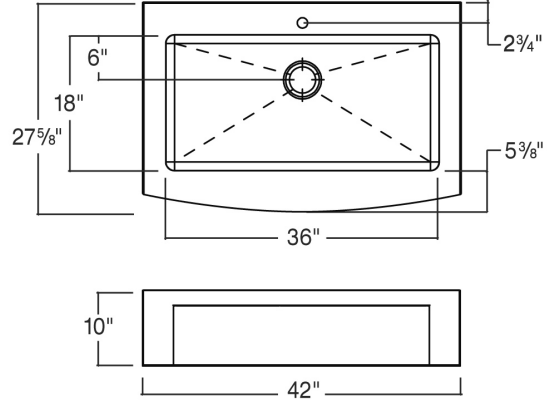

Features

- Handcrafted in Canada using recycled American stainless steel
- Commercial grade - 16 ga material thickness
- Corrosion resistant 304 series stainless steel (18/10)
- Elegant no. 4 brushed finish (appliance finish)
- Highly efficient sound deadening pads
- Practical flat sink bottom and straight bowl sides
- Stylish and functional bowl bottom grooves
- Functional pull-out drawer
- Integrated 1-3/8" faucet hole
- Rear 3-1/2" drain placement
- Limited lifetime warranty

Standards compliance

- ASME A112.19.3
- CSA B45.0
- CSA B45.4

Optional accessories

- Colander 205014
- Cutting board 210049
- Drain fitting 100056
- Drain fitting 100080
- Drain fitting 100081
- Drain fitting 100082
- Drain fitting 100083
- Grid 200221

Sink dimensions

Model	Overall	Bowl	Depth	Cabinet Size*	Drain
000171	42" x 27.63"	36" x 18"	8"	42"	3 1/2"
000151	36" x 27.63"	30" x 18"	8"	36"	3 1/2"
000161	30" x 27.63"	24" x 18"	8"	30"	3 1/2"

* Cabinet Size is the Recommended Cabinet Size

Product specifications

Sink type to be farmhouse single bowl with functional pull-out front drawer. Sink to be handcrafted from a single sheet of 16 ga stainless steel having 18/10 chrome/nickel content and a no.4 brushed finish. Sink to feature bowl bottom grooves, rear 3 1/2" drain placement and sound deadening pads. Sink overall dimensions to be 42" left-to-right and 27.63" front-to-back. Bowl dimensions to be 36" left-to-right and 18" front-to-back. Sink to feature 29mm radius corners. Sink to be Julien Classic™ collection model 000171 with bowl depth of 8".

Warranty

Julien inc. offers a LIMITED LIFETIME WARRANTY on the fix components of its stainless steel sinks against defects of material and workmanship. For further details on our product warranty, please refer to our catalog or Web site.