

MODEL NUMBER:

- R800 Deck-Mount Tub Filler**
 Rough valve only. 1/2" sweat inlets.
 For use with Colony Soft, Princeton, Tropic, Dazzle and Hampton Tub Spouts.
- R810 Deck-Mount Tub Filler**
 10" Fixed Copper to Copper.

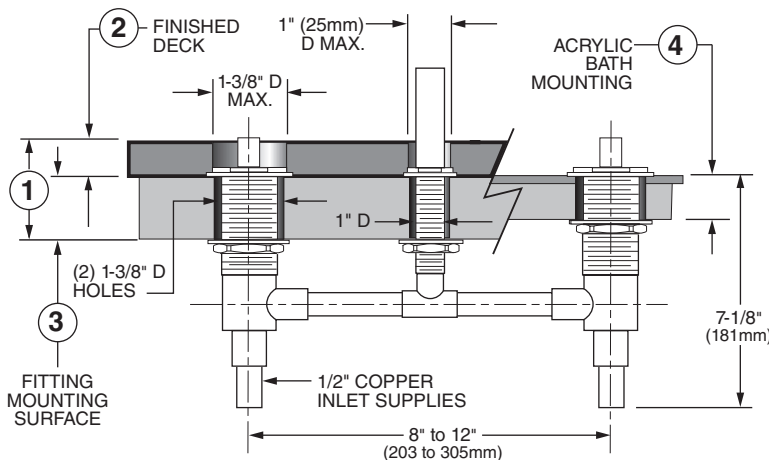

- 1. DECK THICKNESS**
 TOTAL DECK THICKNESS UP TO 2-1/2"
- 2. FINISHED DECK**
 FINISHED DECK VARIABILITY ACCOMMODATES DECKING MATERIAL (TILE, MARBLE, CORIAN@...) TO 1" THICK
- 3. FITTING MOUNTING SURFACE**
 ADJUSTABILITY, TO 1-1/2" THICK
- 4. ACRYLIC BATHS**
 ADJUSTABILITY, TO 1-1/2" THICK

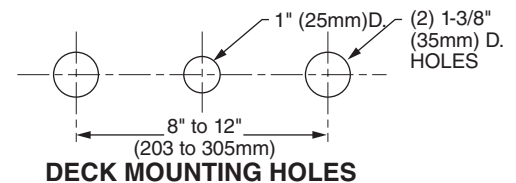

GENERAL DESCRIPTION:

R800 features separate brass and 1/2" copper waterway below deck provided for adjustable installations, R810 features a 10" fixed copper to copper. Washerless 1/4 turn ceramic disc valve cartridges. Total rough-in up to 2-1/2". Rough valve body provides 1-1/2" for rough deck installation. Trim kits provide an additional 1" adjustability for finished deck. Valve body will accept a variety of decorative spouts and handles. Personal shower with separate diverter available (R890).

PRODUCT FEATURES:

- Brass Construction:** Durable. Ideal for prolonged contact with water.
- Ceramic Disc Valve Cartridges:** Assures a lifetime of drip-free performance.
- Many Trim Options:** Wide range of handle & spout styles.

CODES AND STANDARDS

These products meet or exceed the following codes and standards:



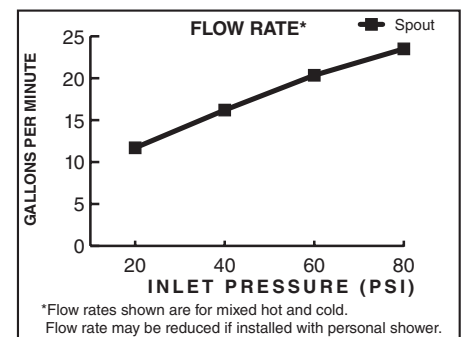







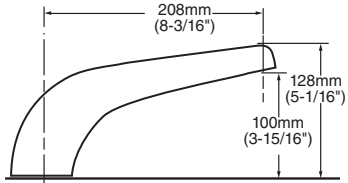

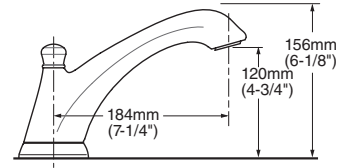
ASME A112.18.1
CSA B 125.1

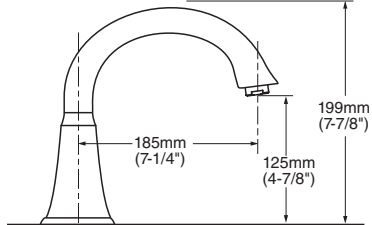

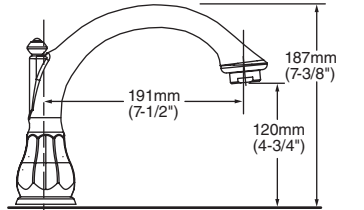
SUGGESTED SPECIFICATION:

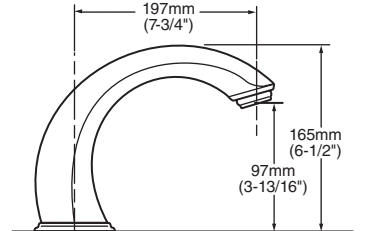
Two handle deck-mount tub filler shall feature cast brass construction with brass and copper waterway. Shall also feature 1/4 turn washerless ceramic disc valve cartridges that are reversible for use with round or lever handles. Fitting shall be American Standard Model # _____ and trim kit # _____.

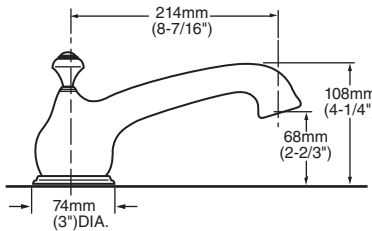
TRIM KITS FOR R800 Rough Valve Bodies

Trim Kit	Model No. Description	Finishes	Roughing-In Dimensions
 <p>T975.500</p>	<p>COLONY® SOFT TRIM KIT</p> <ul style="list-style-type: none"> • Cast Brass slip-fit spout • Lever Handles • LESS Valve 	<p>.002 Polished Chrome .295 Satin Nickel (PVD)</p>	
 <p>T508.900</p>	<p>PRINCETON® TRIM KIT</p> <ul style="list-style-type: none"> • Cast Brass slip-fit spout • Metal Lever Handles • LESS Valve 	<p>.002 Polished Chrome .224 Oil Rubbed Bronze .295 Satin Nickel (PVD)</p>	
 <p>T038.900</p>	<p>TROPIC® TRIM KIT</p> <ul style="list-style-type: none"> • Cast Brass slip-fit spout • Metal Lever Handles • LESS Valve 	<p>.002 Polished Chrome .295 Satin Nickel (PVD)</p>	
 <p>T028.900</p>	<p>DAZZLE® TRIM KIT</p> <ul style="list-style-type: none"> • Cast brass slip-fit spout • Metal Lever Handles • LESS Valve 	<p>.002 Polished Chrome .224 Oil Rubbed Bronze .295 Satin Nickel (PVD)</p>	
 <p>T980.712</p>	<p>HAMPTON® TRIM KIT</p> <ul style="list-style-type: none"> • Brass Crescent slip-fit spout • LESS Valve <ul style="list-style-type: none"> • Porcelain Lever Handles 	<p>.002 Polished Chrome .295 Satin Nickel (PVD)</p>	
 <p>T980.732</p>	<ul style="list-style-type: none"> • Metal Lever Handles 	<p>.002 Polished Chrome .099 Polished Brass (PVD) .295 Satin Nickel (PVD)</p>	
 <p>T970.712</p>	<p>HAMPTON® TRIM KIT</p> <ul style="list-style-type: none"> • Cast brass slip-fit spout • LESS Valve <ul style="list-style-type: none"> • Porcelain Lever Handles 	<p>.002 Polished Chrome .295 Satin Nickel (PVD)</p>	
 <p>T970.732</p>	<ul style="list-style-type: none"> • Metal Lever Handles 	<p>.002 Polished Chrome .099 Polished Brass (PVD) .295 Satin Nickel (PVD)</p>	