

Alexis

The **Alexis** is the essence of style and luxury in any spacious bath environment.

Available Sizes:

60" L x 48" W x 20" D
 65 Gallons



Acrylic Tub – construction features

Acrylic models finished in 1/8" thick layer of deep lustrous acrylic.

Extra thick reinforced fiberglass.

Pre-wired pump on pump platform (standard pump location only)

Integral E-Z Level platform facilitates installation.

Non-skid bottom.

PVC Systems – include:

8 Fully directional adjustable PVC jets

Anti-vortex safety suction.

Color matched system trim

Hydrozone ozone sanitation system

Rigid PVC piping

Self draining pump and system

Soft Touch electronic on/off control with 30-min. integral timer

2.25 HP Single Speed Pump

Cable waste & overflow

Hydro Systems – Options:

Available as Tub only, Thermal Air, Whirlpool or Combo

Microban Antibacterial Protection

Extra High Density Fiberglass

Custom jet and pump locations

Flange - molded

Waterfall Fill Spout (recirculating option available)

Skirt

Plated Metallic finish

Additional directional Jets

Swirling, Rotating, or Jumbo Jets

Micro Therapy Jet

Integral Waste & Overflow

1.5 HP Variable Speed Pump (digital temperature display optional)

Electronic low water protection

In-line Heater

Chromatherapy-LED Lighting System

Chromatherapy-LED Mini Spotlights

Mood Light

Grab Bars

Back Masseuse

Neck Masseuse Pillow

Hydro Fragrance

Hydro Fusion

Hydro Coat

Hydro Express quick ship





Approvals & Listings

Commonwealth of Massachusetts
 UPC & USPC - US & Canada

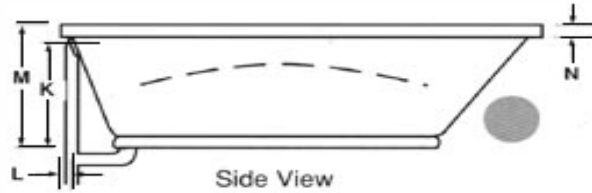
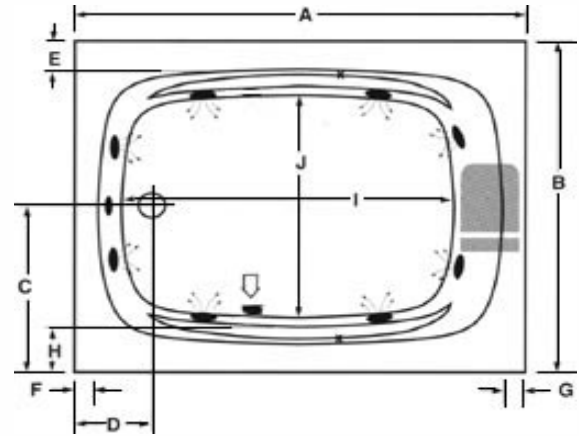

Alexis



-  Pump motor
 -  Jets
 -  Anti-vortex suction
 -  Overflow location
- Must be set in Mortar Base
- AS SHOWN:**
Whirlpool option w/ standard jets
- ALSO AVAILABLE:**
Soaking Tub Only, Thermal Air, Combo

Model	GC	AC	A	B	C	D	E	F	G	H	I	J	K	L	M	Jets	Pump	Wat.Cap.
6048	N/A		59½"	47¾"	23⅞"	10½"	4"	3¼"	3¼"	6½"	43"	32"	17½"	2½"	20"	8	2.25	65 gal.
Amps		Volts		Breaker		Dedicated Service												
13.5		120		20 amps		GFCI Protected												

Framing Dimension

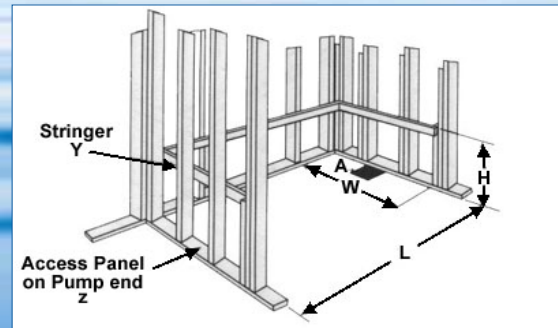
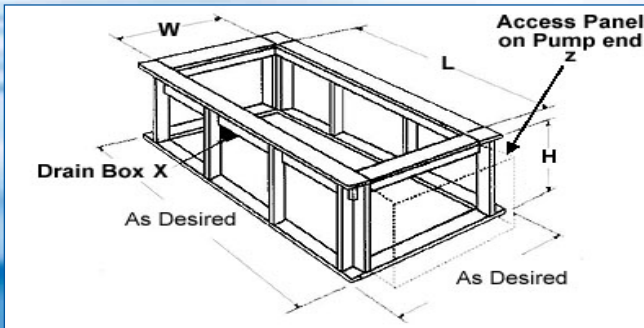

Island Drop-In

3 Wall Installation

Model	(L)ength	(W)idth	(H)eighth Finish	(L)ength	(W)idth	(H)eighth Ledger - Molded Flange
6048	57½"	45¾"	19¼"	59½"	47¾"	20¾"

Disclaimer: Certain options or altering the pump/blower location may cause the pump/blower to extend beyond the tub decking. For cutout dimensions wait for unit to arrive. All specifications subject to change without notice.