

M Collection
Wall-mount vanity
18" height



Furniture

Wall-mount vanity M 2418 WM – 1 drawer – 24" length

21 7/8" depth x 23 9/16" length x 18" height – 557 x 598 x 457 mm

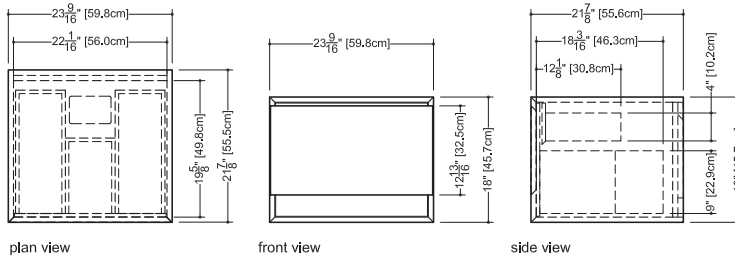

finishes and colors

oak

natural
white
wenge
light grey
blue steel
sand
hemp
smoked

walnut

natural
chocolate

matte lacquer*

white
light grey
blue steel
sand
hemp

high gloss lacquer**

white

- 45 degree bevel cuts precluding the need for drawer hardware
 - all natural wood veneer on dimensionally stable MDF core
 - AWI rated level 5 marine grade finish for moisture resistance and durability (industry's highest finishing class)
 - finished vanity interiors in addition to front and sides finished vanity interiors in addition to front and sides
 - solid maple dovetailed drawer
 - divider for storage
 - drawer within a drawer
 - slow closing ball bearing glides
 - special wall preparation recommendations
- The distance between studs should not exceed 16". Each stud should be reinforced vertically by 2" x 3" wooden studs and horizontally with 2" x 6" wooden studs at a height of 30" all along the width of the vanity.

*ATTENTION: Vessel sink not recommended with this finish

**ATTENTION: High-Gloss finish on sides and drawer facade only. Bottom and interior in white mat. This finish should only be ordered with an integrated countertop (vessel sink not recommended)

WETSTYLE cannot be held responsible for any technical errors and reserves the right to make revisions without notice.

Approximate measurement.
The manufacturer accepts 1/4" (6.35mm) variance.

www.WETSTYLE.CA - Montreal - Canada
Tel. 450.536.9000 - 1 888.536.9001 - Fax. 450.536.0202



Compatible Integrated Countertop for M 2418 WM vanity (countertop sold separately)

Cube Collection Lavatories_22" depth x 24" length x 2" height - 559 x 610 x 51 mm

VCS 24

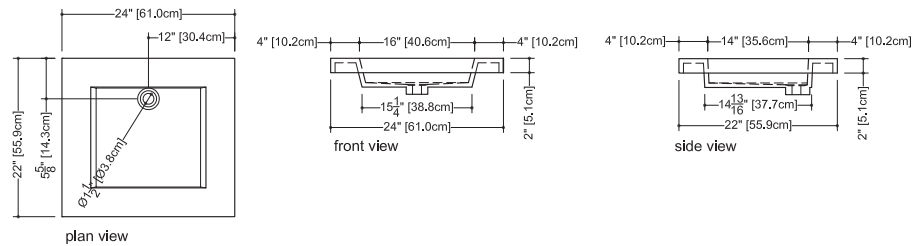

Ove Collection Integrated Countertop_22" depth x 24" length x 2" height - 559 x 610 x 51 mm

VOVS 24

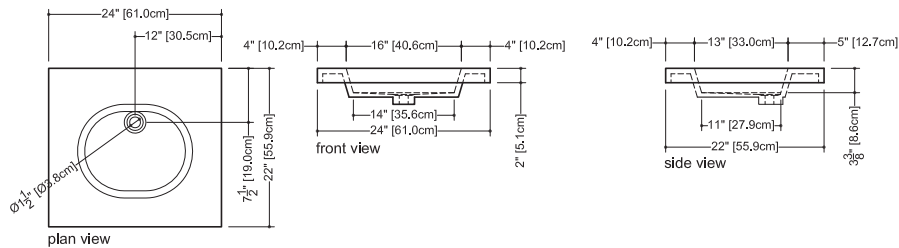

Also compatible with the following WETSTYLE vessel sink models:

VBE821A, VC815A, VC821A, VOV815A, VOV821A, VCR821A, VTP821A

WETSTYLE cannot be held responsible for any technical errors and reserves the right to make revisions without notice.

Approximate measurement.
The manufacturer accepts $\frac{1}{4}$ " (6.35mm) variance.

www.WETSTYLE.CA - Montreal - Canada
Tel. 450.536.9000 - 1 888.536.9001 - Fax. 450.536.0202



M Collection
Wall-mount vanity
18" height



Furniture

Wall-mount vanity M 3618 WM – 1 drawer – 36" length

21 7/8" depth x 35 5/8" length x 18" height – 557 x 905 x 457 mm

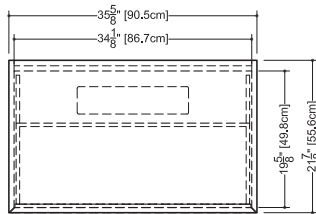

plan view

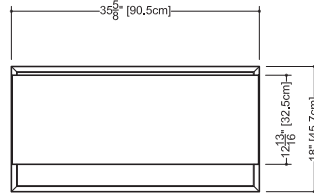

front view

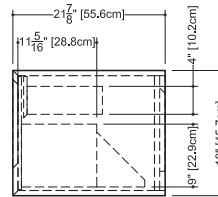

side view

finishes and colors

oak

natural
white
wenge
light grey
blue steel
sand
hemp
smoked

matte lacquer*

white
light grey
blue steel
sand
hemp

walnut

natural
chocolate

high gloss lacquer**

white

- 45 degree bevel cuts precluding the need for drawer hardware
- all natural wood veneer on dimensionally stable MDF core
- AWI rated level 5 marine grade finish for moisture resistance and durability (industry's highest finishing class)
- finished vanity interiors in addition to front and sides finished vanity interiors in addition to front and sides
- solid maple dovetailed drawer
- divider for storage
- drawer within a drawer
- slow closing ball bearing glides
- special wall preparation recommendations
The distance between studs should not exceed 16". Each stud should be reinforced vertically by 2" x 3" wooden studs and horizontally with 2" x 6" wooden studs at a height of 30" all along the width of the vanity.

*ATTENTION: Vessel sink not recommended with this finish

**ATTENTION: High-Gloss finish on sides and drawer facade only. Bottom and interior in white mat. This finish should only be ordered with an integrated countertop (vessel sink not recommended)

WETSTYLE cannot be held responsible for any technical errors and reserves the right to make revisions without notice.

Approximate measurement.
The manufacturer accepts 1/4" (6.35mm) variance.

www.WETSTYLE.CA - Montreal - Canada
Tel. 450.536.9000 - 1 888.536.9001 - Fax. 450.536.0202



Compatible Integrated Countertop for M 3618 WM vanity (countertop sold separately)

Cube Collection Lavatories_22" depth x 36" length x 2" height - 559 x 914 x 51 mm

VCS 36C

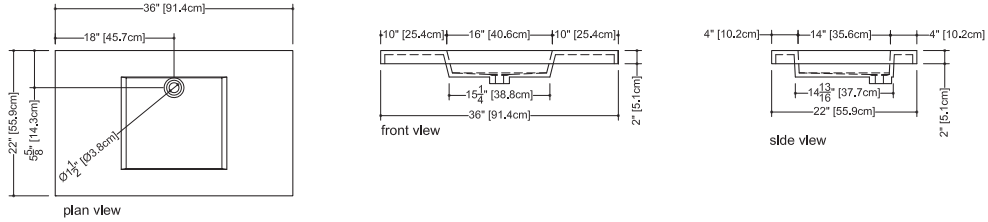

VCS 36L

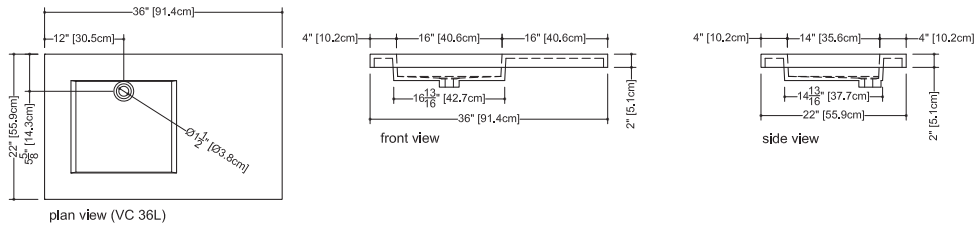

VCS 36R

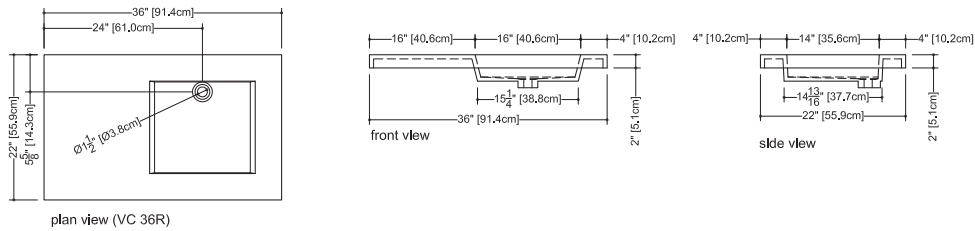

VCS 36

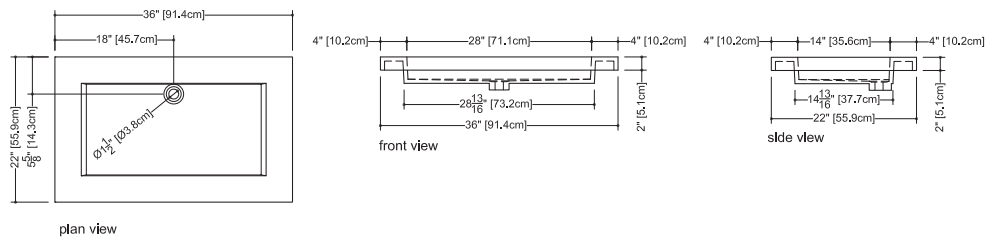

Ove Collection Lavatories_22" depth x 36" length x 2" height - 559 x 914 x 51 mm

VOVS 36

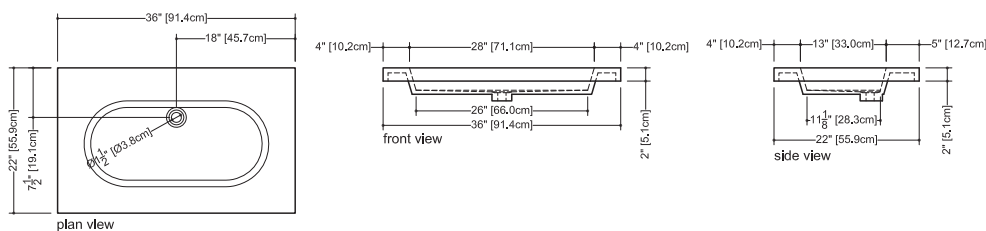

Also compatible with the following WETSTYLE vessel sink models:

VBE821A, VC815A, VC821A, VOV815A, VOV821A, VCR821A, VTP821A

WETSTYLE cannot be held responsible for any technical errors and reserves the right to make revisions without notice.

Approximate measurement.
The manufacturer accepts 1/8" (6.35mm) variance.

www.WETSTYLE.CA - Montreal - Canada
Tel. 450.536.9000 - 1 888.536.9001 - Fax. 450.536.0202



M Collection
 Wall-mount vanity
 18" height



Furniture

Wall-mount vanity M 4818 WM – 2 drawers – 48" length

21 7/8" depth x 47 5/8" length x 18" height – 557 x 1210 x 457 mm

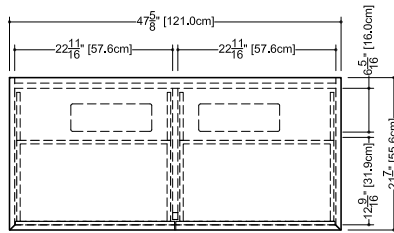

plan view

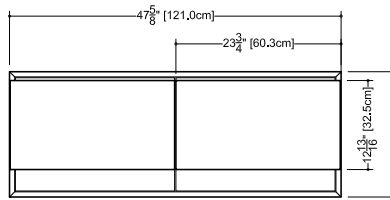

front view

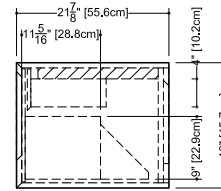

side view

finishes and colors

oak

natural
 white
 wenge
 light grey
 blue steel
 sand
 hemp
 smoked

matte lacquer*

white
 light grey
 blue steel
 sand
 hemp

walnut

natural
 chocolate

high gloss lacquer**

white

- 45 degree bevel cuts precluding the need for drawer hardware
- all natural wood veneer on dimensionally stable MDF core
- AWI rated level 5 marine grade finish for moisture resistance and durability (industry's highest finishing class)
- finished vanity interiors in addition to front and sides finished vanity interiors in addition to front and sides
- solid maple dovetailed drawer
- divider for storage
- drawer within a drawer
- slow closing ball bearing glides
- special wall preparation recommendations
 The distance between studs should not exceed 16". Each stud should be reinforced vertically by 2" x 3" wooden studs and horizontally with 2" x 6" wooden studs at a height of 30" all along the width of the vanity.

*ATTENTION: Vessel sink not recommended with this finish

**ATTENTION: High-Gloss finish on sides and drawer facade only. Bottom and interior in white mat. This finish should only be ordered with an integrated countertop (vessel sink not recommended)

WETSTYLE cannot be held responsible for any technical errors and reserves the right to make revisions without notice.

Approximate measurement.
 The manufacturer accepts 1/4" (6.35mm) variance.

www.WETSTYLE.CA - Montreal - Canada
 Tel. 450.536.9000 - 1 888.536.9001 - Fax. 450.536.0202



Compatible Integrated Countertop for M 4818 WM vanity (countertop sold separately)

Cube Collection Integrated Lavatories_22" depth x 48" length x 2" height - 559 x 1219 x 51 mm

VCS 48L

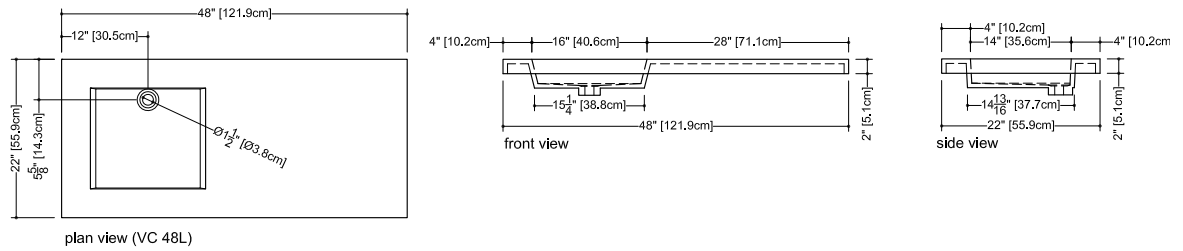

VCS 48R

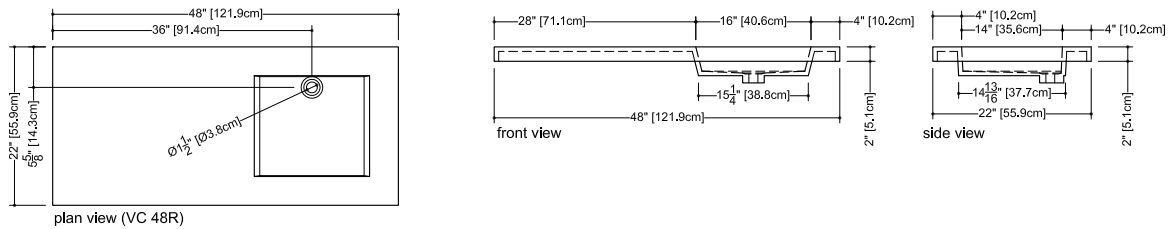

VCS 48

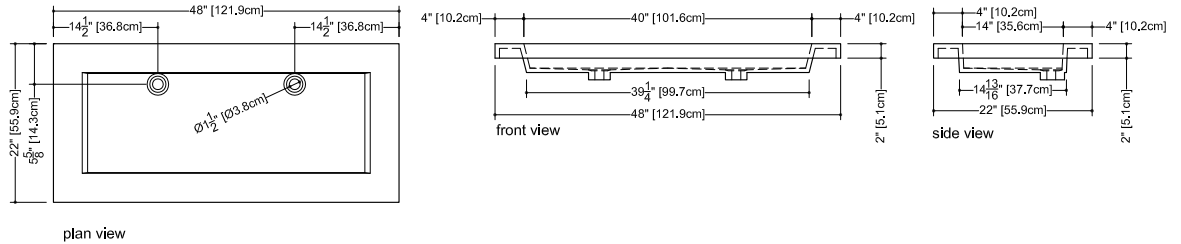

Compatible Integrated Countertop for M 4818 WM vanity (countertop sold separately)

Ove Collection Lavatories_22" depth x 48" length x 2" height - 559 x 1219 x 51 mm

VOVS 48

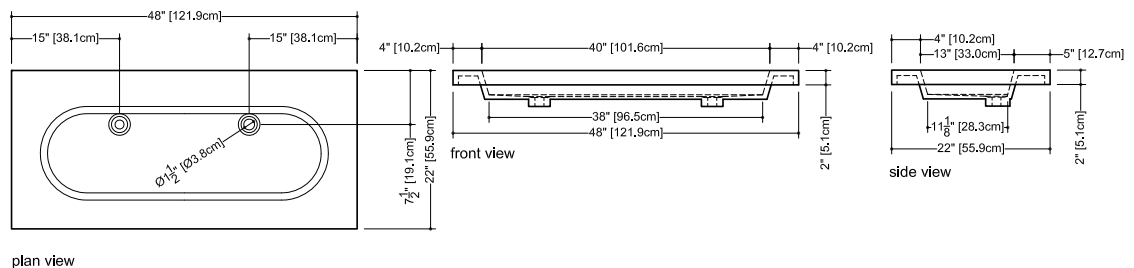

Also compatible with the following WETSTYLE vessel sink models:

VBE821A, VBE836A, VC815A, VC821A, VC836A, VOV815A, VOV821A, VOV836A, VCR821A, VTP821A

WETSTYLE cannot be held responsible for any technical errors and reserves the right to make revisions without notice.

Approximate measurement.
The manufacturer accepts 1/4" (6.35mm) variance.

www.WETSTYLE.CA - Montreal - Canada
Tel. 450.536.9000 - 1 888.536.9001 - Fax. 450.536.0202



M Collection
Wall-mount vanity
18" height



Furniture

Wall-mount vanity M 6018 WM – 2 drawers – 60" length

21 7/8" depth x 60" length x 18" height – 557 x 1524 x 457 mm

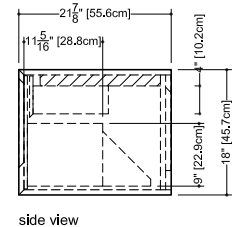
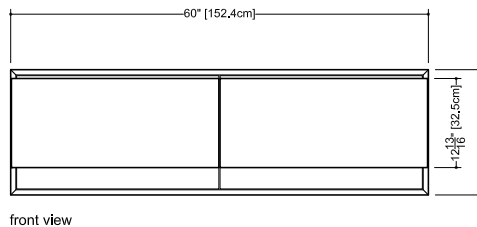
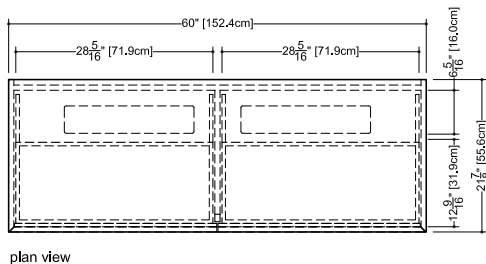

finishes and colors

oak

natural
white
wenge
light grey
blue steel
sand
hemp
smoked

matte lacquer*

white
light grey
blue steel
sand
hemp

walnut

natural
chocolate

high gloss lacquer**

white

- 45 degree bevel cuts precluding the need for drawer hardware
- all natural wood veneer on dimensionally stable MDF core
- AWI rated level 5 marine grade finish for moisture resistance and durability (industry's highest finishing class)
- finished vanity interiors in addition to front and sides finished vanity interiors in addition to front and sides
- solid maple dovetailed drawer
- divider for storage
- drawer within a drawer
- slow closing ball bearing glides
- special wall preparation recommendations

The distance between studs should not exceed 16". Each stud should be reinforced vertically by 2" x 3" wooden studs and horizontally with 2" x 6" wooden studs at a height of 30" all along the width of the vanity.

*ATTENTION: Vessel sink not recommended with this finish

**ATTENTION: High-Gloss finish on sides and drawer facade only. Bottom and interior in white mat. This finish should only be ordered with an integrated countertop (vessel sink not recommended)

WETSTYLE cannot be held responsible for any technical errors and reserves the right to make revisions without notice.

Approximate measurement.
The manufacturer accepts 1/4" (6.35mm) variance.

www.WETSTYLE.CA - Montreal - Canada
Tel. 450.536.9000 - 1 888.536.9001 - Fax. 450.536.0202



Compatible Integrated Countertop for M 6018 WM vanity (countertop sold separately)

Cube Collection Lavatories_22" depth x 60 1/4" length x 2" height - 559 x 1530 x 51 mm

VCS 60L

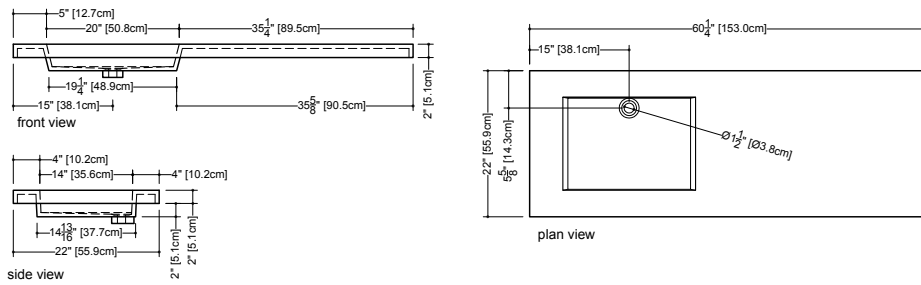

VCS 60R

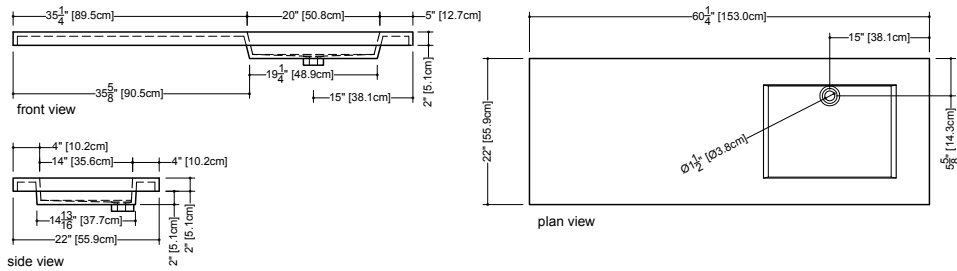

VCS 60

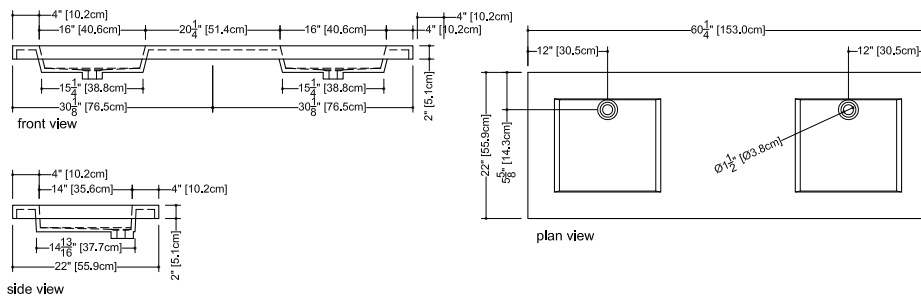

VCS 60T

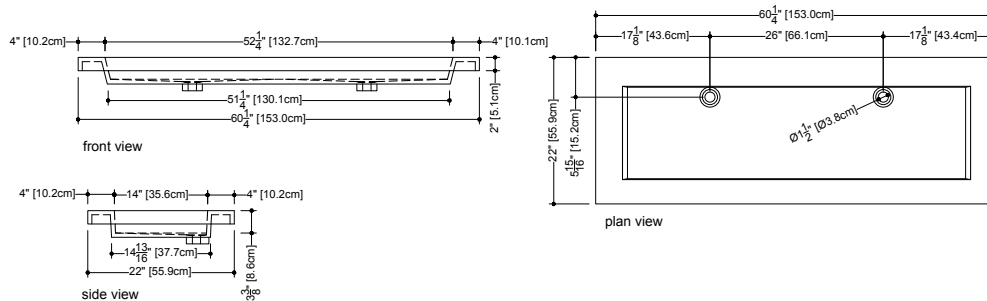

Also compatible with the following WETSTYLE vessel sink models:

VBE821A, VBE836A, VC815A, VC821A, VC836A, VC848A, VOV815A, VOV821A, VOV836A, VOV848A, VCR821A, VTP821A

M Collection
Wall-mount vanity
18" height



Wall-mount vanity M 7218 WM – 3 drawers – 72" length

21 7/8" depth x 72" length x 18" height – 557 x 1829 x 457 mm

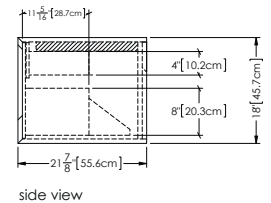
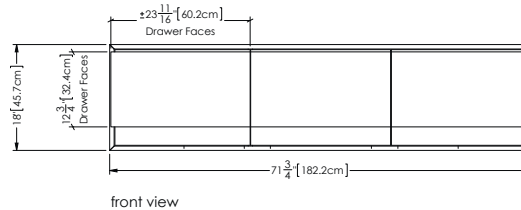
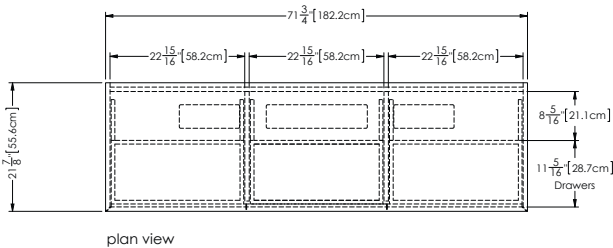

finishes and colors

oak

natural
white
wenge
light grey
blue steel
sand
hemp
smoked

matte lacquer*

white
light grey
blue steel
sand
hemp

walnut

natural
chocolate

high gloss lacquer**

white

- 45 degree bevel cuts precluding the need for drawer hardware
- all natural wood veneer on dimensionally stable MDF core
- AWI rated level 5 marine grade finish for moisture resistance and durability (industry's highest finishing class)
- finished vanity interiors in addition to front and sides finished vanity interiors in addition to front and sides
- solid maple dovetailed drawer
- divider for storage
- drawer within a drawer
- slow closing ball bearing glides
- special wall preparation recommendations

The distance between studs should not exceed 16". Each stud should be reinforced vertically by 2" x 3" wooden studs and horizontally with 2" x 6" wooden studs at a height of 30" all along the width of the vanity.

*ATTENTION: Vessel sink not recommended with this finish

**ATTENTION: High-Gloss finish on sides and drawer facade only. Bottom and interior in white mat. This finish should only be ordered with an integrated countertop (vessel sink not recommended)

WETSTYLE cannot be held responsible for any technical errors and reserves the right to make revisions without notice.

Approximate measurement.
The manufacturer accepts 1/4" (6.35mm) variance.

www.WETSTYLE.CA - Montreal - Canada
Tel. 450.536.9000 - 1 888.536.9001 - Fax. 450.536.0202



Compatible Integrated Countertop for M 7218 WM vanity (countertop sold separately)

Cube Collection Lavatories_22" depth x 72" length x 2" height - 559 x 1829 x 51 mm

VCS 72

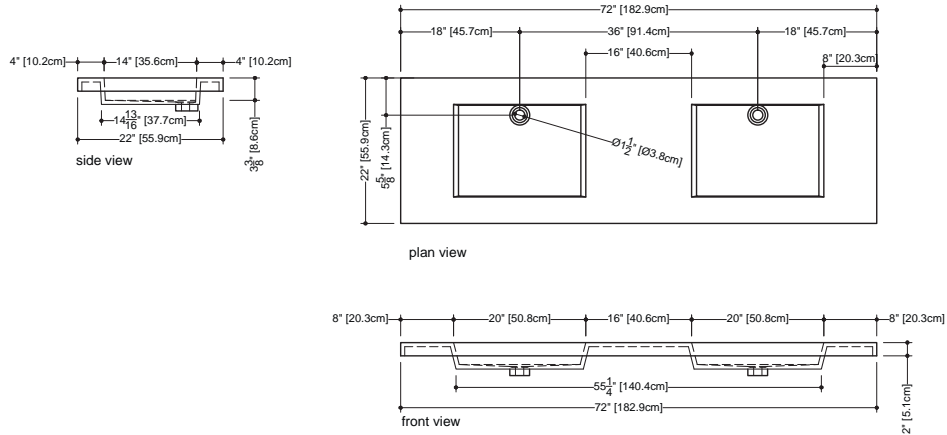

VCS 72T

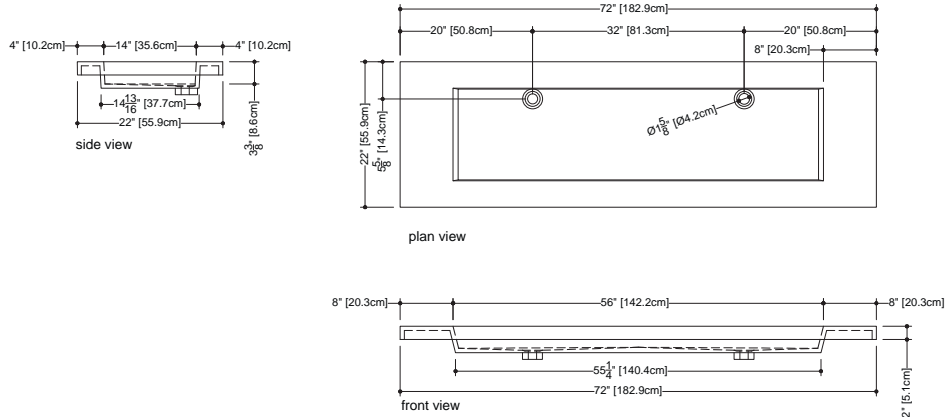

Also compatible with the following WETSTYLE vessel sink models:

VBE821A, VBE836A, VC815A, VC821A, VC836A, VC848A, VOV815A, VOV821A, VOV836A, VOV848A, VCR821A, VTP821A