

# Select Panel Radiators

## The One Range Solution

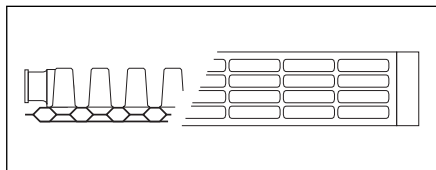

### Type 11G

Single convector with factory fitted top grill and end panels. Available in outputs from 1,243 Btu/hr to 7,217 Btu/hr.

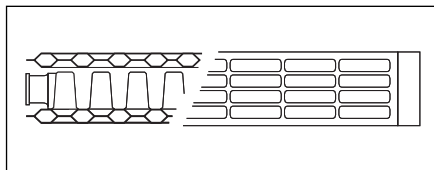

### Type 21G

Single convector with factory fitted top grill and end panels. Available in outputs from 1,857 Btu/hr to 10,138 Btu/hr.

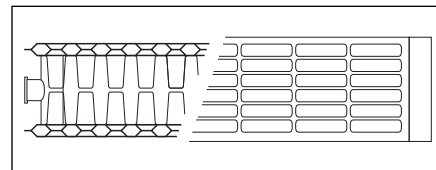

### Type 22G

Standard double convector radiator with factory fitted top grill and end panels. Available in outputs from 2,430 Btu/hr to 13,031 Btu/hr.

## General Specifications

### APPROVAL AND CERTIFICATION

All Myson Select Radiators are manufactured and tested to BS EN 442.

Every radiator carries the BS Kitemark, which certifies independent approval of heat output and verifies production under a quality system to BS EN ISO 9002.



### OPERATING PRESSURES

Every radiator is pressure tested at 101.5 psi and is suitable for working pressures up to 78 psi.

### PAINT FINISH

Every radiator undergoes a multistage pre-treatment process followed by an epoxy polyester primer coat. An epoxy polyester powder coat in white (RAL 9010) is applied to all front and rear surfaces allowing the Myson Select to be fitted without further painting.

### APPLICATION

Myson Select Radiators are for use on two pipe pumped indirect domestic and commercial central heating installations, with a maximum working temperature of 212°F. The system should be designed with particular care taken to avoid air entry or water discharge.

We do not recommend the use of single feed indirect cylinders, as the possibility of aeration due to water interchange may lead to corrosion.

The installation work must be carried out in accordance with recognized good practice, and precautions taken to avoid contamination which could lead to corrosion. If a corrosion inhibitor or other water treatment is to be used, the manufacturer's instructions must be strictly followed.

### CONNECTIONS

All Myson Select Radiators are fitted with four 1/2 inch BSP connections.

An air vent and plug are packed with every radiator.

### PACKAGING

Each radiator is individually wrapped in strong polyethylene reinforced with corner protection pieces.

The pack is clearly marked with the type and size, and mounting brackets are included within the pack.

### MOUNTING BRACKETS

All radiators are supplied with concealed wall mounting brackets to accommodate different wall

construction details. The brackets include plastic inserts to minimize noise caused by the expansion and contraction of the radiator.

### HEAT OUTPUT

Careful design of an optimum profile for the convector plate, and welding directly onto the water channels have combined to give high heat output per surface area of radiator.

The heat outputs shown in the tables are based on a mean water to air temperature difference of 108°F. When the difference is not 108°F, the output should be multiplied by the appropriate factor from the table below:

Factor	Temp. Difference
0.605	72°F
0.700	81°F
0.798	90°F
0.898	99°F
1.000	108°F
1.104	117°F
1.211	126°F

# Myson Select Panel Radiator vs. Baseboard

## *The Choice is Yours*

### Select Panel Radiators

- Mounts on the wall, off the floor, making the cleaning of floors and carpeting simple
- Range of sizes: Select offers a full line which provides from 1,243 Btu/hr to over 13,000 Btu/hr depending on the length and height of the radiator
- Efficient: Deliver two to four times the heat output of hydronic baseboard per running foot
- Quick, responsive, quiet and uniform heating
- Advanced welding techniques allow the convector plates to be welded directly to the water channel, providing quiet, gentle and responsive heating
- Up-to-date fashionable high gloss finish
- Tested to over 100 psi hydrostatic pressure
- Compact: Fits snugly to the wall, requiring only 3"-5<sup>3/16</sup>" of depth
- Backed by Myson's 5 Year Warranty, including leaks, external corrosion, flaking or peeling of the epoxy/polyester enamel powder coat finish
- Everything's in one pack - no on-site assembly

### Baseboard\*

- Over time, baseboards become a dirt trap that cannot be cleaned
- Consumes long lengths of wall space while providing much less heat than Select
- Only one fourth to one half of the Btu per running foot
- Rapid temperature fluctuations
- Typically has that annoying "ticking" noise due to the fins touching each other as they are heating up

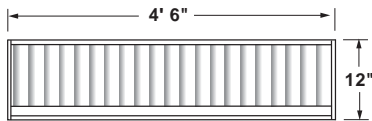

SX30140 (4,333 Btu/hr)

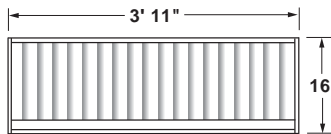
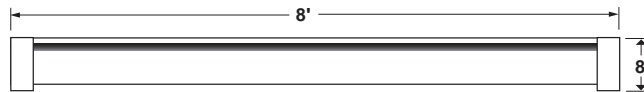

SX40120 (4,758 Btu/hr)

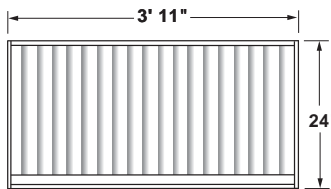
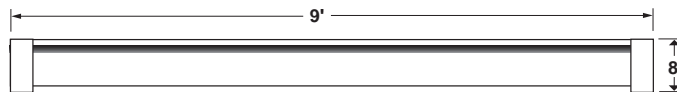

SX60120 (6,698 Btu/hr)

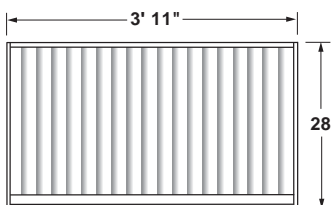
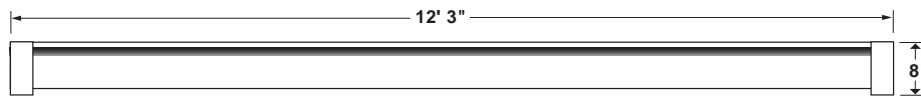

SX70120 (7,603 Btu/hr)

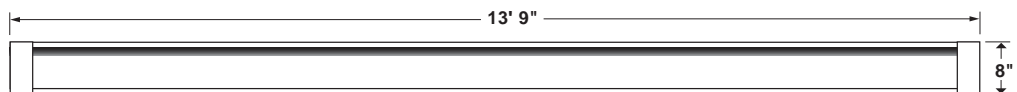

\*Baseboard @ 550 Btu/hr/ft



**Select Type 11G Single Convactor**

Nominal Height (in)	Actual Height (in)	Actual Length (in)	Output (Btu/hr)	Order Code	Weight (lbs)	Water Content (gals)
12	11 <sup>13</sup> / <sub>16</sub>	23 <sup>5</sup> / <sub>8</sub>	1243	SS 30 60G	11.4	0.26
		39 <sup>3</sup> / <sub>8</sub>	2071	SS 30 100G	18.5	0.43
		55 <sup>1</sup> / <sub>8</sub>	2900	SS 30 140G	26.1	0.60
		70 <sup>7</sup> / <sub>8</sub>	3728	SS 30 180G	33.7	0.77
16	15 <sup>3</sup> / <sub>4</sub>	19 <sup>11</sup> / <sub>16</sub>	1360	SS 40 50G	12.7	0.27
		23 <sup>5</sup> / <sub>8</sub>	1632	SS 40 60G	15.2	0.32
		27 <sup>9</sup> / <sub>16</sub>	1904	SS 40 70G	17.7	0.38
		31 <sup>1</sup> / <sub>2</sub>	2175	SS 40 80G	19.6	0.42
		35 <sup>7</sup> / <sub>16</sub>	2447	SS 40 90G	22.2	0.47
		39 <sup>3</sup> / <sub>8</sub>	2719	SS 40 100G	24.7	0.52
		47 <sup>1</sup> / <sub>4</sub>	3263	SS 40 120G	29.8	0.63
		63	4351	SS 40 160G	39.9	0.84
24	23 <sup>5</sup> / <sub>8</sub>	15 <sup>3</sup> / <sub>4</sub>	1576	SS 60 40G	15.1	0.32
		19 <sup>11</sup> / <sub>16</sub>	1970	SS 60 50G	18.8	0.42
		23 <sup>5</sup> / <sub>8</sub>	2365	SS 60 60G	22.6	0.50
		27 <sup>9</sup> / <sub>16</sub>	2759	SS 60 70G	26.4	0.59
		31 <sup>1</sup> / <sub>2</sub>	3153	SS 60 80G	29.2	0.65
		35 <sup>7</sup> / <sub>16</sub>	3547	SS 60 90G	33.0	0.74
		39 <sup>3</sup> / <sub>8</sub>	3941	SS 60 100G	36.7	0.82
		43 <sup>5</sup> / <sub>16</sub>	4335	SS 60 110G	40.5	0.90
		47 <sup>1</sup> / <sub>4</sub>	4729	SS 60 120G	44.3	1.00
		51 <sup>3</sup> / <sub>16</sub>	5123	SS 60 130G	48.0	1.07
		55 <sup>1</sup> / <sub>8</sub>	5517	SS 60 140G	51.8	1.15
		63	6305	SS 60 160G	59.3	1.32
28	27 <sup>9</sup> / <sub>16</sub>	15 <sup>3</sup> / <sub>4</sub>	1804	SS 70 40G	20.1	0.33
		19 <sup>11</sup> / <sub>16</sub>	2255	SS 70 50G	25.2	0.50
		23 <sup>5</sup> / <sub>8</sub>	2706	SS 70 60G	30.2	0.60
		27 <sup>9</sup> / <sub>16</sub>	3157	SS 70 70G	35.2	0.70
		31 <sup>1</sup> / <sub>2</sub>	3609	SS 70 80G	39.0	0.78
		35 <sup>7</sup> / <sub>16</sub>	4060	SS 70 90G	44.1	0.88
		39 <sup>3</sup> / <sub>8</sub>	4511	SS 70 100G	49.1	0.98
		47 <sup>1</sup> / <sub>4</sub>	5413	SS 70 120G	59.1	1.18
		55 <sup>1</sup> / <sub>8</sub>	6315	SS 70 140G	69.2	1.38
		63	7217	SS 70 160G	79.3	1.58

**Select Mounting Panel for Bracket Installation**

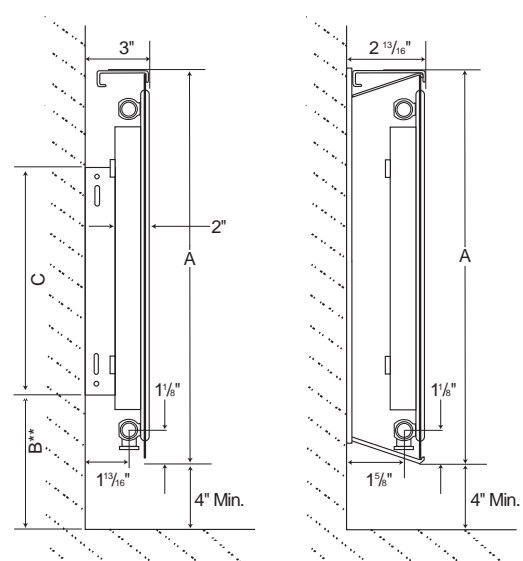

**For Solid or Concrete Walls**      **Conventional Wall Framing**

(dimensions noted below)

Nominal Height	A	B**	C
12"	11 <sup>13</sup> / <sub>16</sub> "	6 <sup>1</sup> / <sub>4</sub> "	6 <sup>1</sup> / <sub>4</sub> "
16"	15 <sup>3</sup> / <sub>4</sub> "	8 <sup>3</sup> / <sub>16</sub> "	6 <sup>1</sup> / <sub>4</sub> "
24"	23 <sup>5</sup> / <sub>8</sub> "	9"	12 <sup>3</sup> / <sub>8</sub> "
28"	27 <sup>9</sup> / <sub>16</sub> "	10 <sup>15</sup> / <sub>16</sub> "	12 <sup>3</sup> / <sub>8</sub> "

\*\*Includes a minimum clearance of 4" from floor to bottom of Select Radiator

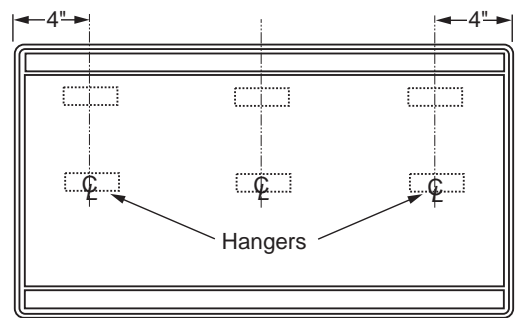

Select Radiators are supplied with two different sets of wall brackets to accommodate different wall construction details. The brackets include plastic inserts to minimize noise caused by the expansion and contraction of the radiator.

Note: The stamping on the bracket indicates which slot to use. The plastic inserts should be fitted into the bracket slots. Most Select Radiators require 2 brackets, positioned 4" from each side. Longer units have a third bracket in the center.

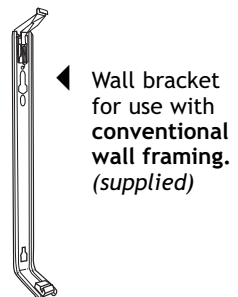
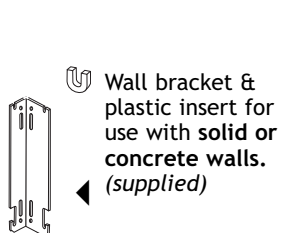

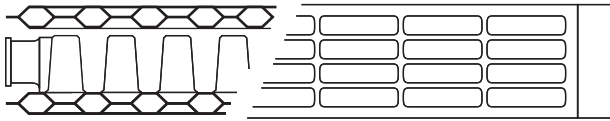

## Select Type 21G Double Panel Single Convectector

Nominal Height (in)	Actual Height (in)	Actual Length (in)	Output (Btu/hr)	Order Code	Weight (lbs)	Water Content (gals)
12	11 <sup>13/16</sup>	23 <sup>5/8</sup>	1857	SX 30 60G	19.4	0.56
		39 <sup>3/8</sup>	3095	SX 30 100G	31.6	0.90
		55 <sup>1/8</sup>	4333	SX 30 140G	44.6	1.27
		70 <sup>7/8</sup>	5570	SX 30 180G	57.6	1.64
16	15 <sup>3/4</sup>	19 <sup>11/16</sup>	1982	SX 40 50G	21.2	0.56
		23 <sup>5/8</sup>	2379	SX 40 60G	25.5	0.68
		27 <sup>9/16</sup>	2775	SX 40 70G	29.7	0.79
		31 <sup>1/2</sup>	3172	SX 40 80G	32.9	0.87
		35 <sup>7/16</sup>	3568	SX 40 90G	37.1	0.98
		39 <sup>3/8</sup>	3965	SX 40 100G	41.4	1.10
		47 <sup>1/4</sup>	4758	SX 40 120G	49.9	1.32
24	23 <sup>5/8</sup>	63	6344	SX 40 160G	66.8	1.77
		15 <sup>3/4</sup>	2233	SX 60 40G	25.5	0.68
		19 <sup>11/16</sup>	2791	SX 60 50G	31.8	0.84
		23 <sup>5/8</sup>	3349	SX 60 60G	38.2	1.01
		27 <sup>9/16</sup>	3907	SX 60 70G	44.6	1.18
		31 <sup>1/2</sup>	4466	SX 60 80G	49.3	1.31
		35 <sup>7/16</sup>	5024	SX 60 90G	55.7	1.47
		39 <sup>3/8</sup>	5582	SX 60 100G	62.1	1.64
		43 <sup>5/16</sup>	6140	SX 60 110G	68.4	1.81
		47 <sup>1/4</sup>	6698	SX 60 120G	74.8	1.98
28	27 <sup>9/16</sup>	51 <sup>3/16</sup>	7257	SX 60 130G	81.1	2.15
		55 <sup>1/8</sup>	7815	SX 60 140G	87.5	2.31
		63	8931	SX 60 160G	100.2	2.65
		15 <sup>3/4</sup>	2534	SX 70 40G	33.3	0.82
		19 <sup>11/16</sup>	3168	SX 70 50G	41.6	1.02
		23 <sup>5/8</sup>	3802	SX 70 60G	50.0	1.23
		27 <sup>9/16</sup>	4435	SX 70 70G	58.3	1.43
		31 <sup>1/2</sup>	5069	SX 70 80G	64.5	1.59
		35 <sup>7/16</sup>	5702	SX 70 90G	72.8	1.79
		39 <sup>3/8</sup>	6336	SX 70 100G	81.2	1.99
47 <sup>1/4</sup>	7603	SX 70 120G	97.8	2.40		
55 <sup>1/8</sup>	8871	SX 70 140G	114.4	2.81		
63	10138	SX 70 160G	131.1	3.22		

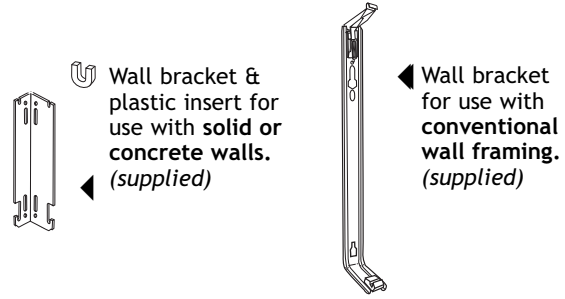

### Select Side Profile with Brackets

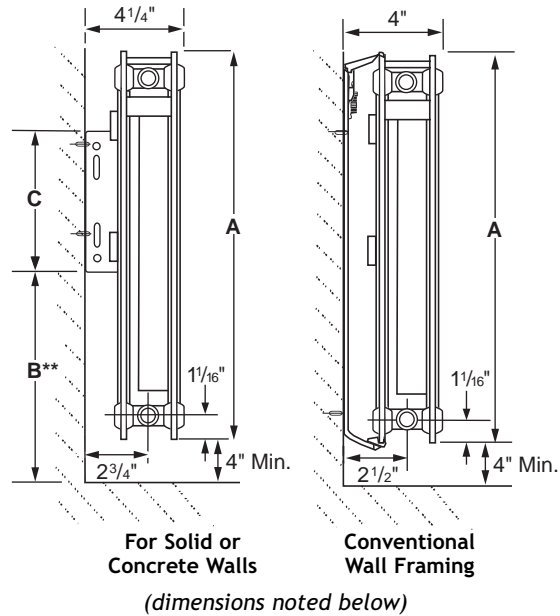

Nominal Height	A	B**	C
12"	11 <sup>13/16</sup> "	6 <sup>1/4</sup> "	6 <sup>1/4</sup> "
16"	15 <sup>3/4</sup> "	8 <sup>3/16</sup> "	6 <sup>1/4</sup> "
24"	23 <sup>5/8</sup> "	9"	12 <sup>3/8</sup> "
28"	27 <sup>9/16</sup> "	10 <sup>15/16</sup> "	12 <sup>3/8</sup> "

\*\* Includes a minimum clearance of 4" from floor to bottom of Select Radiator

### Select Mounting Panel for Bracket Installation

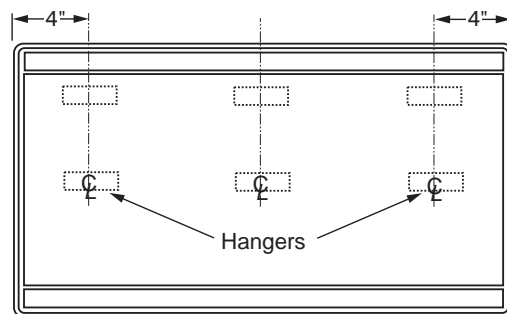

Select Radiators are supplied with two different sets of wall brackets to accommodate different wall construction details. The brackets include plastic inserts to minimize noise caused by the expansion and contraction of the radiator.

Note: The stamping on the bracket indicates which slot to use. The plastic inserts should be fitted into the bracket slots. Most Select Radiators require 2 brackets, positioned 4" from each side. Longer units have a third bracket in the center.

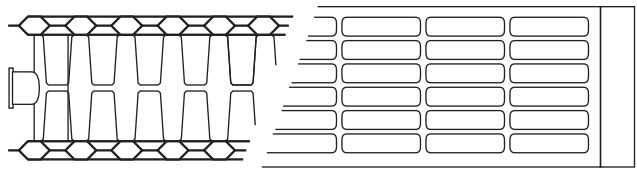

**Select Type 22G Double Convactor**

Nominal Height (in)	Actual Height (in)	Actual Length (in)	Output (Btu/hr)	Order Code	Weight (lbs)	Water Content (gals)
12	11 <sup>13/16</sup>	23 <sup>5/8</sup>	2430	SD 30 60G	21.6	0.56
		39 <sup>3/8</sup>	4050	SD 30 100G	35.1	0.90
		55 <sup>1/8</sup>	5670	SD 30 140G	49.5	1.27
		70 <sup>7/8</sup>	7290	SD 30 180G	63.9	1.64
16	15 <sup>3/4</sup>	19 <sup>11/16</sup>	2603	SD 40 50G	24.2	0.56
		23 <sup>5/8</sup>	3124	SD 40 60G	29.1	0.68
		27 <sup>9/16</sup>	3645	SD 40 70G	33.9	0.79
		31 <sup>1/2</sup>	4165	SD 40 80G	37.6	0.87
		35 <sup>7/16</sup>	4686	SD 40 90G	42.4	0.98
		39 <sup>3/8</sup>	5207	SD 40 100G	47.2	1.10
		47 <sup>1/4</sup>	6248	SD 40 120G	56.9	1.32
63	8331	SD 40 160G	76.3	1.77		
24	23 <sup>5/8</sup>	15 <sup>3/4</sup>	2900	SD 60 40G	29.2	0.68
		19 <sup>11/16</sup>	3625	SD 60 50G	36.4	0.84
		23 <sup>5/8</sup>	4350	SD 60 60G	43.7	1.01
		27 <sup>9/16</sup>	5075	SD 60 70G	51.0	1.18
		31 <sup>1/2</sup>	5800	SD 60 80G	56.5	1.31
		35 <sup>7/16</sup>	6525	SD 60 90G	63.7	1.47
		39 <sup>3/8</sup>	7251	SD 60 100G	71.0	1.64
		43 <sup>5/16</sup>	7976	SD 60 110G	78.3	1.81
		47 <sup>1/4</sup>	8701	SD 60 120G	85.6	1.98
		51 <sup>3/16</sup>	9426	SD 60 130G	92.9	2.15
		55 <sup>1/8</sup>	10151	SD 60 140G	100.1	2.31
63	11601	SD 60 160G	114.7	2.65		
28	27 <sup>9/16</sup>	15 <sup>3/4</sup>	3258	SD 70 40G	39.2	0.82
		19 <sup>11/16</sup>	4072	SD 70 50G	49.0	1.02
		23 <sup>5/8</sup>	4887	SD 70 60G	58.8	1.23
		27 <sup>9/16</sup>	5701	SD 70 70G	68.6	1.43
		31 <sup>1/2</sup>	6516	SD 70 80G	76.0	1.59
		35 <sup>7/16</sup>	7330	SD 70 90G	85.8	1.79
		39 <sup>3/8</sup>	8144	SD 70 100G	95.6	2.00
		47 <sup>1/4</sup>	9773	SD 70 120G	115.2	2.40
		55 <sup>1/8</sup>	11402	SD 70 140G	134.8	2.81
		63	13031	SD 70 160G	154.4	3.22

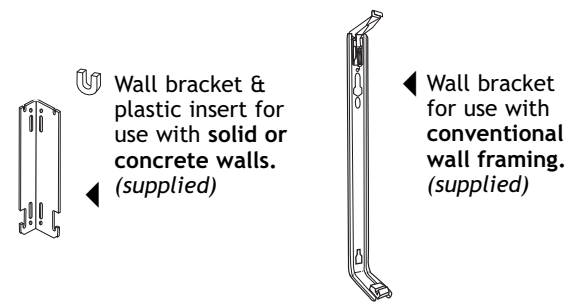

**Select Side Profile with Brackets**

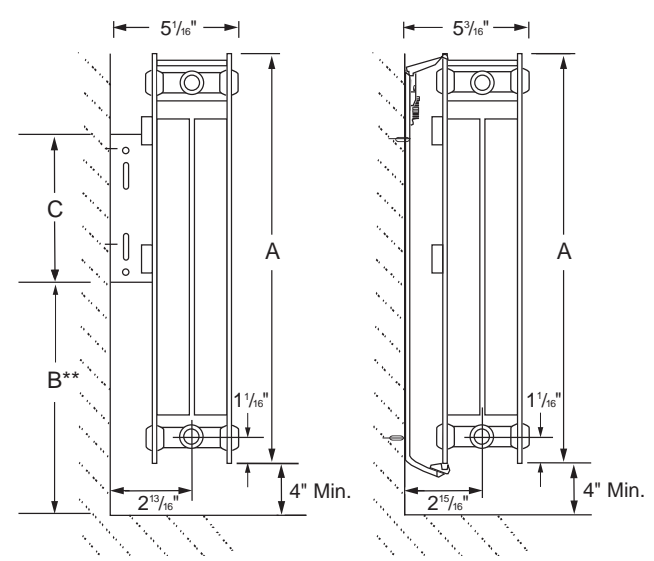

For Solid or Concrete Walls      Conventional Wall Framing

(dimensions noted below)

Nominal Height	A	B**	C
12"	11 <sup>13/16</sup> "	6 <sup>1/4</sup> "	6 <sup>1/4</sup> "
16"	15 <sup>3/4</sup> "	8 <sup>3/16</sup> "	6 <sup>1/4</sup> "
24"	23 <sup>5/8</sup> "	9"	12 <sup>3/8</sup> "
28"	27 <sup>9/16</sup> "	10 <sup>15/16</sup> "	12 <sup>3/8</sup> "

\*\* Includes a minimum clearance of 4" from floor to bottom of Select Radiator

**Select Mounting Panel for Bracket Installation**

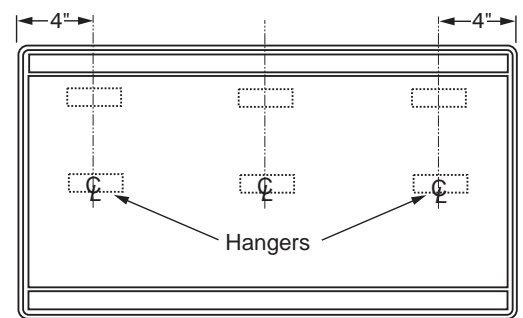

Select Radiators are supplied with two different sets of wall brackets to accommodate different wall construction details. The brackets include plastic inserts to minimize noise caused by the expansion and contraction of the radiator.

Note: The stamping on the bracket indicates which slot to use. The plastic inserts should be fitted into the bracket slots. Most Select Radiators require 2 brackets, positioned 4" from each side. Longer units have a third bracket in the center.

## Heat Output Adjustment Factors

### Temperature Difference<sup>1</sup>

°F	65	70	75	80	85	90	95	100	105	108	110	115	120	125	130
°C	36	39	42	44	47	50	53	56	58	60	61	64	67	69	72

### Adjustment Multiplier

0.53	0.59	0.64	0.69	0.74	0.80	0.85	0.91	0.97	1.00	1.02	1.08	1.14	1.20	1.26
------	------	------	------	------	------	------	------	------	------	------	------	------	------	------

<sup>1</sup>Certified heat output is based upon tests conducted at a room temperature of 68°F (20°C) and a mean water temperature of 176°F (80°C) using T.B.O.E. (Top, Bottom, Opposite End) connections. For temperature differences other than 108°F (60°C) used for these tests, multiply the heat output (given in the table above) by the adjustment multiplier given in this table which correspond to the desired performance conditions. B.O.E. (Bottom, Opposite End) connections give slightly lower heat output.

## Selection of Sizes

Myson has a Select or Eclipse Radiator model to meet every room situation and Btu output requirement. The following examples use Select models.

**Select SX-70-90G**  
 Heat Output: 5702 Btu/hr  
 Length: 35.4"  
 Water Content: 1.71 gal



28"

**Select SX-60-100G**  
 Heat Output: 5582 Btu/hr  
 Length: 39.4"  
 Water Content: 1.63 gal

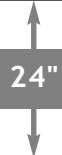

24"

**Select SX-40-160G**  
 Heat Output: 6344 Btu/hr  
 Length: 63"  
 Water Content: 1.66 gal



16"

**Select SX-30-180G**  
 Heat Output: 5570 Btu/hr  
 Length: 70.9"  
 Water Content: 1.60 gal



12"

### STEP 1: Determine the heat output rating needed.

Use the tables (above) to determine the Heat Output Rating required for a specific situation. See the example below.

### STEP 2: Check the locations.

Make sure you are aware of any restrictions with the length or height. (Window or wall dimensions should be reviewed.)

### STEP 3: Pick the size & model you require.

Select offers a range of sizes and often can provide the required heat with any one of several models. The example below illustrates the range of choices possible.

**QUESTION:** Room needs about 4500 Btu/hr on a low water temperature system. Will the SX-70-90G do the job?

**Requirement:** 4500 Btu/hr (actual heat output)

**Conditions:** Hot water temperature: 158°F  
 Room air temperature: 68°F  
 Temperature difference: 90°F

**Calculation:** Adjust the Certified Heat Output from the top table to account for the lower temperature difference between the hot water supply and the room air. (The table is based upon a difference of 108°F.)

#### Example:

Certified Heat Output for  
 Model SX-70-90G: **5702 Btu/hr** (page 4)  
 Adjustment Multiplier at 90°F: **x 0.80** (2nd table)  
 Actual Heat Output: **4562 Btu/hr**

**Answer:** The SX-70-90G provides what the room needs.

**Question:** Will other models do the job?

**Answer:** YES. Any one of the models described to the left will work.