

Discontinued product



SKF TKTL 30

Instructions for use
Mode d'emploi
Bedienungsanleitung
Instrucciones de uso

Manuale d'istruzioni
Instruções de uso
使用说明书
Инструкция по эксплуатации

EC DECLARATION OF CONFORMITY

We, SKF Maintenance Products, Kelvinbaan 16, 3439 MT Nieuwegein, The Netherlands, declare that the

SKF Infrared Thermometer TKTL 30

is been designed and manufactured in accordance with European Directive EMC 2004/108/EC as outlined in the standards

EN 61326-1:2006 CISPR 11:2003, class B IEC 61000-4-2:2008

EN 61326-2-2:2006

IEC 61000-4-3:2008

The laser complies with 21CFR, Ch 1-J

The Netherlands, January 2011



Sébastien David

Manager Product Development and Quality



TKTL 30
MP5382

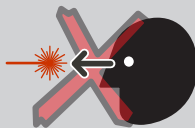

CAUTION AVOID EXPOSURE
LASER RADIATION IS EMITTED
FROM THIS APERTURE



LASER RADIATION
DO NOT STARE INTO BEAM
CLASS II LASER PRODUCT



Max. Output < 1mW, Wavelength: 635-650nm
Complies with 21CFR, Chapter 1, Subchapter J

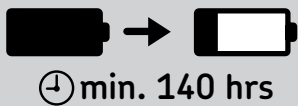
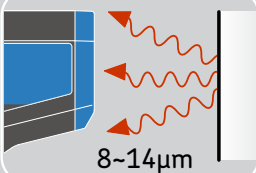
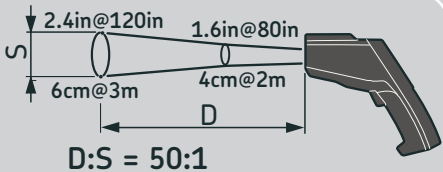
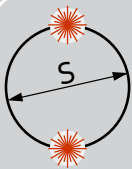
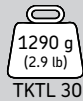
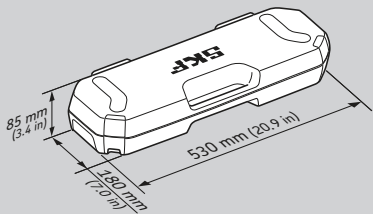
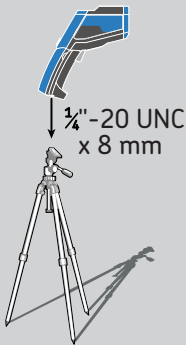
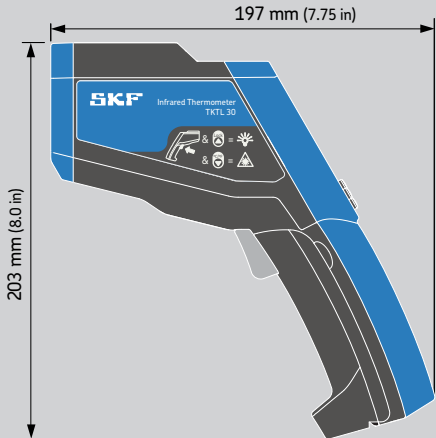

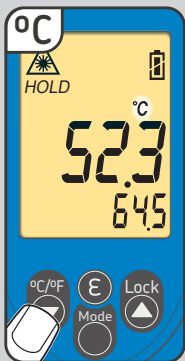
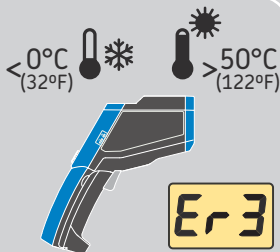
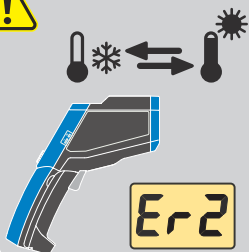
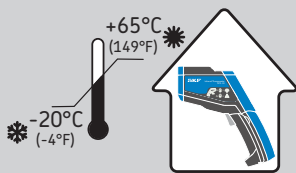
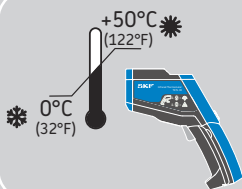
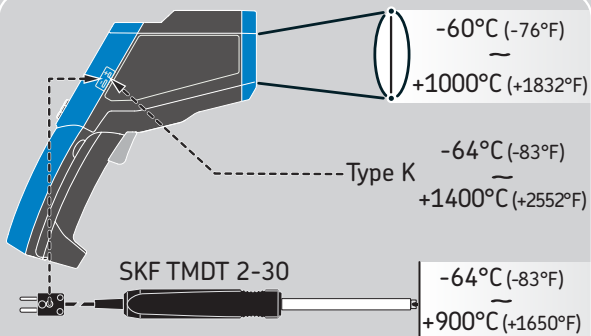



AUTO-OFF

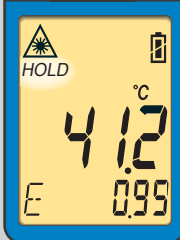

⌚ 1min

AUTO-OFF

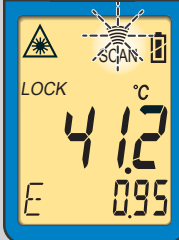

⌚ 60min

AUTO-OFF

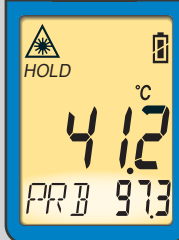

⌚ 12min

LOCK

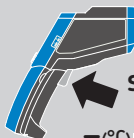
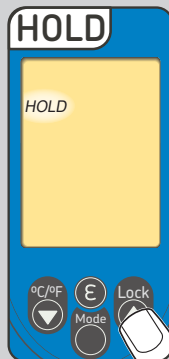
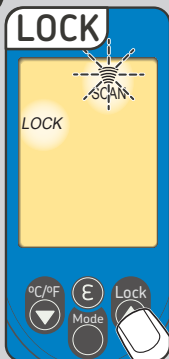

start 1 sec

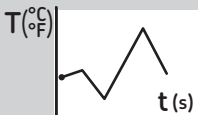

1 sec

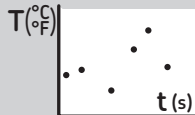

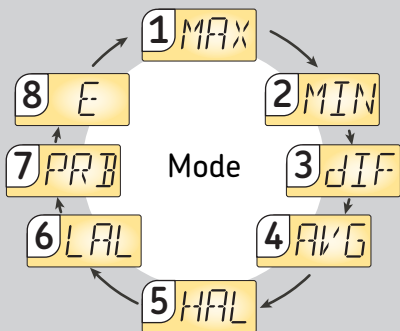

5 HAL

HOLD

78.3 °C

HAL 108

°C/°F Mode Lock

6 LAL

HOLD

64.5 °C

LAL 56

°C/°F Mode Lock

°C/°F Mode Lock

- +

°C/°F Mode Lock

- +

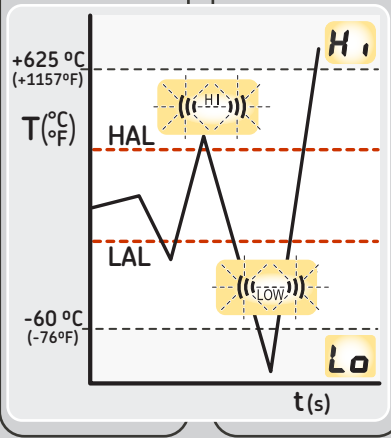

1 MAX

HOLD

41.2 °C

MAX 53.1

°C/°F Mode Lock

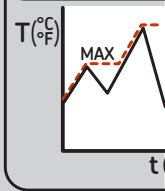

7 PRB

HOLD

34

PRB

°C/°F Mode Lock



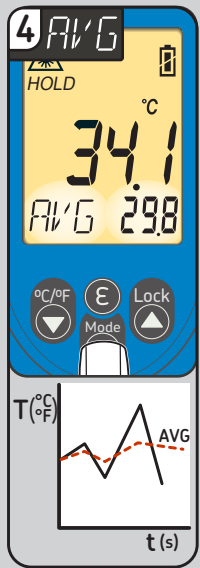
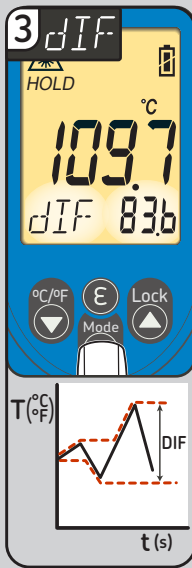
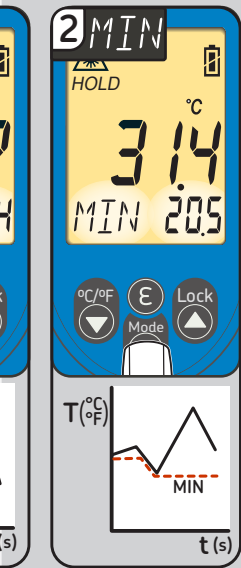

°C (-83°F)

°C (+1999°F)



&

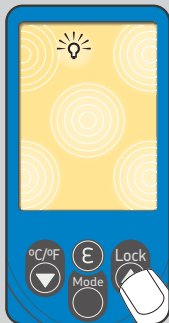

=



&

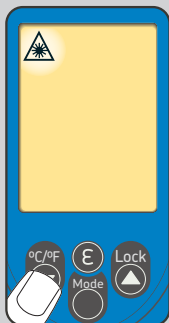

=

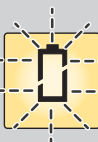

1

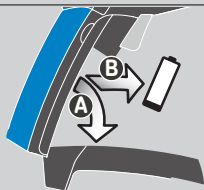

2

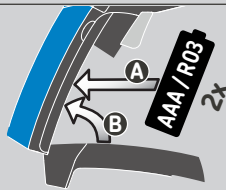

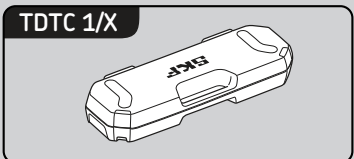
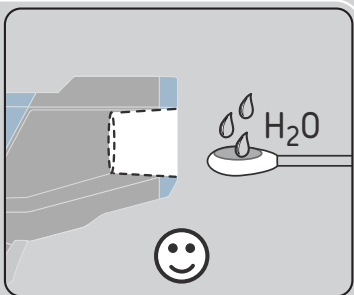
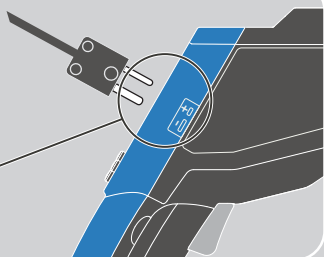
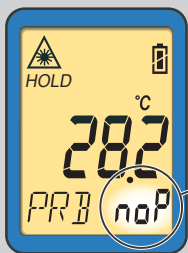

The contents of this publication are the copyright of the publisher and may not be reproduced (even extracts) unless prior written permission is granted. Every care has been taken to ensure the accuracy of the information contained in this publication but no liability can be accepted for any loss or damage whether direct, indirect or consequential arising out of the use of the information contained herein.

Le contenu de cette publication est soumis au copyright de l'éditeur et sa reproduction, même partielle, est interdite sans autorisation écrite préalable. Le plus grand soin a été apporté à l'exactitude des informations données dans cette publication mais SKF décline toute responsabilité pour les pertes ou dommages directs ou indirects découlant de l'utilisation du contenu du présent document.

Nachdruck, auch auszugsweise, nur mit unserer vorherigen schriftlichen Genehmigung gestattet. Die Angaben in dieser Druckschrift wurden mit größter Sorgfalt auf ihre Richtigkeit hin überprüft. Trotzdem kann keine Haftung für Verluste oder Schäden irgendwelcher Art übernommen werden, die sich mittelbar oder unmittelbar aus der Verwendung der hier enthaltenen Informationen ergeben.

El contenido de esta publicación es propiedad de los editores y no puede reproducirse (incluso parcialmente) sin autorización previa por escrito. Se ha tenido el máximo cuidado para garantizar la exactitud de la información contenida en esta publicación, pero no se acepta ninguna responsabilidad por pérdidas o daños, ya sean directos, indirectos o consecuentes, que se produzcan como resultado del uso de dicha información.

La riproduzione, anche parziale, del contenuto di questa pubblicazione è consentita soltanto previa autorizzazione scritta della SKF. Nella stesura è stata dedicata la massima attenzione al fine di assicurare l'accuratezza dei dati, tuttavia non si possono accettare responsabilità per eventuali errori od omissioni, nonché per danni o perdite diretti o indiretti derivanti dall'uso delle informazioni qui contenute.

O conteúdo desta publicação é de direito autoral do editor e não pode ser reproduzido (nem mesmo parcialmente), a não ser com permissão prévia por escrito. Todo cuidado foi tomado para assegurar a precisão das informações contidas nesta publicação, mas nenhuma responsabilidade pode ser aceita por qualquer perda ou dano, seja direto, indireto ou consequente como resultado do uso das informações aqui contidas.

本出版物内容的著作权归出版者所有且未经事先书面许可不得被复制（甚至引用）。我们已采取了一切注意措施以确定本出版物包含的信息准确无误，但我们不对因使用此等信息而产生的任何损失或损害承担任何责任，不论此等责任是直接、间接或附随性的。

Содержание этой публикации является собственностью издателя и не может быть воспроизведено (даже частично) без предварительного письменного разрешения. Несмотря на то, что были приняты все меры по обеспечению точности информации, содержащейся в настоящем издании, издатель не несет ответственности за любой ущерб, прямой или косвенный, вытекающий из использования вышеуказанной информации.

SKF Maintenance Products

www.mapro.skf.com
www.skf.com/mount

MP5382

