

BURCO

Instruction Manual Autofill Wallmount Water Boilers (Filtered & Unfiltered Models)

These instructions cover the following Burco models:

	3L	5L	7.5L	10L
Burco Autofill (Filtered)	N/A	069801	N/A	069818
Burco Autofill (Unfiltered)	069924	N/A	069931	N/A



Please read and
keep these
instructions

<p>Glen Dimplex UK Ltd., trading as, Glen Dimplex Heating & Ventilation Millbrook House, Grange Drive, Hedge End, Southampton, SO30 2DF. Web: www.gdhv.com</p>	<p>Glen Dimplex Europe Ltd. Airport Road, Cloghran, Co. Dublin, K67 VE08, Ireland Web: www.glendimplex.com</p>	
<p>Customer Service Tel: +44 [0]344 879 3588 Email: customer.services@glendimplex.com</p>	<p>Customer Service Tel: +353(0)1 842 833 Email: serviceireland@glendimplex.com</p>	
<p>www.burco.co.uk</p>		

© Glen Dimplex. All rights reserved. Material contained in this publication may not be reproduced in whole or in part, without prior permission in writing of Glen Dimplex.

Contents

1.0 About my Product.....	3
2.0 Scope of Delivery	3
3.0 Warnings and Precautions.....	4
4.0 Introduction	5
5.0 Warranty Cover.....	6
6.0 Technical Data.....	6
7.0 Installation	7
7.1 Mounting to Wall.....	7
7.2 Before Connecting to the Power Supply	8
7.3 Connecting to the Water Supply	8
7.4 Venting.....	8
7.5 Electrical Connection	9
8.0 Overflow and Drainage	10
9.0 Operating Instructions	11
9.1 Boiler Overview.....	11
9.2 Controller Overview.....	11
9.3 Controller Set Up	12
10.0 Cleaning and Descaling Advice and Information	16
10.1 Descaling.....	16
11.0 Changing Water Filter (Filtered Models Only).....	17
12.0 Cleaning Instructions	18
13.0 Troubleshooting.....	18
14.0 Disposal	18
15.0 Spare / Replacement Parts	20
16.0 Frequently Asked Questions (FAQ's).....	21
17.0 Warranty Information.....	22
18.0 Terms and Conditions	23

1.0 About my Product

Please take some time to complete the information below, it may save time if you need to contact us for any reason.

Model Number	0					
Serial Number (this can be found on the data badge on the back of the product)						
Date of Purchase						
Purchased from						
In your instruction pack you will find a duplicate data badge which contains all the critical information above. You can peel of the backing and stick in the box below:						





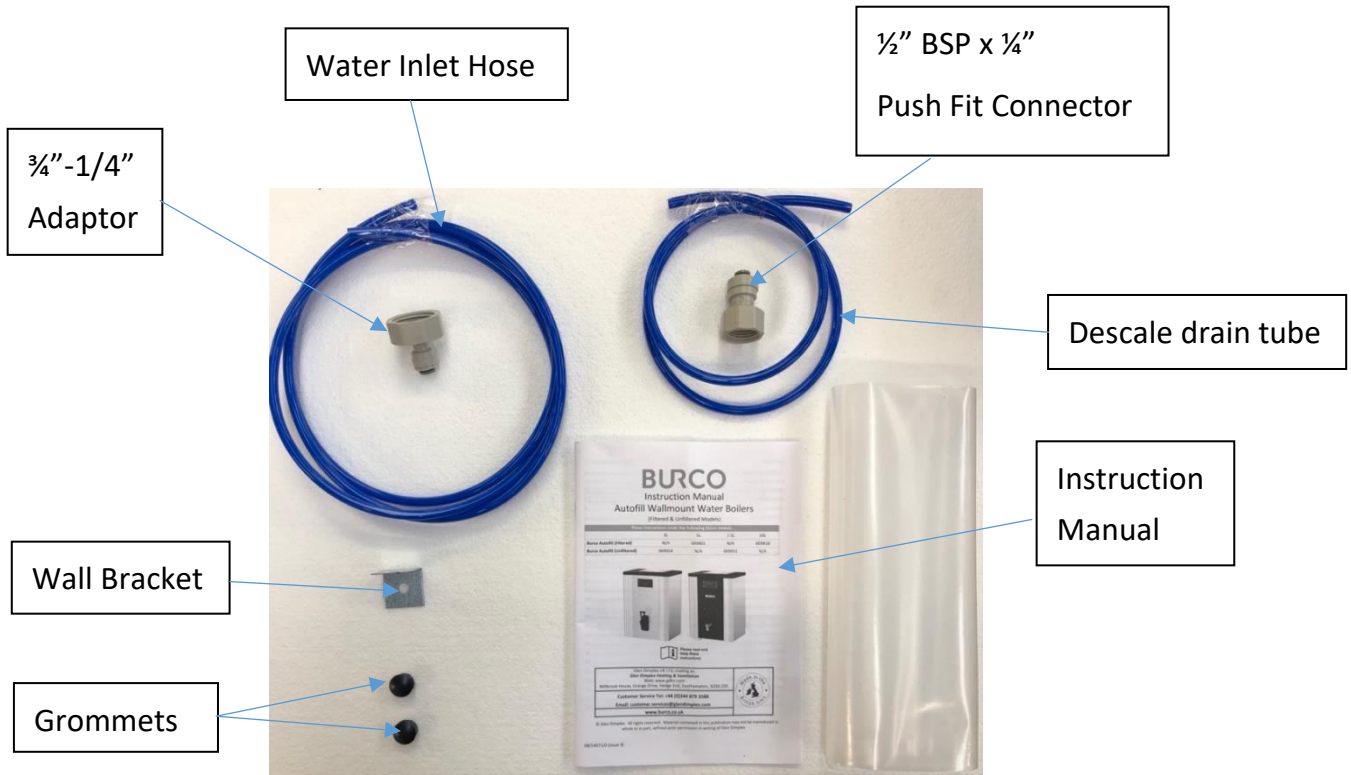



2.0 Scope of Delivery

- Chosen burco boiler variant
- Accessories kit (descale drain tube, water inlet hose, blanking grommets, wall bracket, 3/4-1/4 adaptor, 1/2" BSP x 1/4" push fit connector)
- No Filter for 069924 & 069931
- Instruction booklet



3.0 Warnings and Precautions

	<p>WARNING. THIS SYMBOL MEANS THERE IS A RISK OF PERSONAL INJURY.</p>
	<p>IMPORTANT. THIS SYMBOL MEANS THERE IS A RISK OF DAMAGING THE APPLIANCE</p>
	<p>THIS APPLIANCE MUST BE INSTALLED, COMMISSIONED AND SERVICED BY A QUALIFIED PERSON IN ACCORDANCE WITH THE NATIONAL AND LOCAL REGULATIONS IN FORCE IN THE COUNTRY OF INSTALLATION. ALSO TAKE INTO CONSIDERATION.</p> <ul style="list-style-type: none"> • HEALTH AND SAFETY AT WORKS ACT • IEE REGULATIONS • BS CODES OF PRACTICE • LOCAL AND NATIONAL BUILDING REGULATIONS • LOCAL AND NATIONAL WATER REGULATIONS
	<p>THIS APPLIANCE MUST BE INSTALLED IN LOCATIONS OVERSEEN BY TRAINED PERSONNEL</p>
	<p>THIS APPLIANCE CAN BE USED BY CHILDREN AGED FROM 8 YEARS AND ABOVE AND PERSONS WITH REDUCED PHYSICAL SENSORY OR MENTAL CAPABILITIES OR LACK OF EXPERIENCE AND KNOWLEDGE IF THEY HAVE BEEN GIVEN SUPERVISION</p>

	OR INSTRUCTION CONCERNING USE OF THE APPLIANCE IN A SAFE WAY AND UNDERSTANDING THE HAZARDS INVOLVED. CHILDREN SHALL NOT PLAY WITH THE APPLIANCE. CLEANING AND USER MAINTENANCE SHALL NOT BE MADE BY CHILDREN WITHOUT SUPERVISION.
	DISCONNECT APPLIANCE BEFORE SERVICING, MAINTENANCE OR CLEANING.
	IF THE SUPPLY CORD IS DAMAGED, IT MUST BE REPLACED BY THE MANUFACTURER, ITS SERVICE AGENT OR SIMILARLY QUALIFIED PERSONS IN ORDER TO AVOID A HAZARD.
	THE UNIT MUST BE INSTALLED ON A SOLID CONCRETE / BRICK OR OTHER SUITABLY ROBUST WALL, WITH APPROPRIATE FITTINGS BY A QUALIFIED FITTER. THE COMPANY DOES NOT ACCEPT ANY RESPONSIBILITY FOR THE SAFETY OF ANY UNIT NOT INSTALLED IN THIS WAY.
	DO NOT IMMERSE CORD, PLUG, OR WATER BOILER IN WATER OR ANY OTHER LIQUID.
	THE FLEXIBLE HOSE CONNECTED FROM THE OVERFLOW ALSO ACTS AS A VENT FOR THE APPLIANCE. UNDER NO CIRCUMSTANCES SHOULD THIS FLEXIBLE HOSE BECOME BLOCKED OR RESTRICTED IN ANY WAY.
	THIS APPLIANCE MUST ONLY BE USED FOR HEATING WATER.
	DURING OPERATION PARTS & SURFACES MAY BECOME HOT – AVOID ACCIDENTAL CONTACT.
	THIS APPLIANCE IS NOT SUITABLE FOR OUTDOOR USE OR AN AREA WHERE WATER JET COULD BE USED.

4.0 Introduction

Thank you for purchasing this Burco Autofill Water Boiler.

To ensure you obtain the full benefits from your new appliance:

- Please read this instruction book carefully and follow all advice given. Please pay attention to any warnings.
- If you are unsure of any aspects of the information provided, or the setup and performance of the product, please contact our Aftersales team on +44 [0]344 879 3588 (UK) or +353(0)1 842 833 (ROI)

This boiler is intended for commercial use as detailed in these instructions. The Company has a policy of continuous improvement in product quality and design. The company therefore reserves the right to change the specification at any time.

5.0 Warranty Cover

This Burco boiler comes with a comprehensive 1-year parts and labour warranty (069924 & 069931). If you have purchased a Burco boiler with a water filter, then the warranty is 2 years parts and labour (069801 & 069818).

(Please see full warranty information section)

The warranty **does not** cover:

- Consequential damage arising out of any failure acceptable under warranty.
- Accidental damage or misuse as detailed in these instructions.
- Unauthorised alterations made to the appliance that aren't made by a Burco-approved engineer.
- Consumable items such as filter cartridges.

Any damage due to incorrect installation, or build-up of scale or food debris.

It is important that you descale your water boiler regularly, particularly in hard water areas.

⚠ Failure to descale your water boiler or replace your filter cartridge when prompted to do so, will invalidate your warranty.

6.0 Technical Data

Model	3L	5L	7.5L	10L
Height (mm)	301	486	451	586
Width (mm)	344			
Depth (mm)	234 (310 Inc. tap)			
Capacity (Litres)	3	5	7.5	10
Weight (Kg) *dry	10	11.5	11	13
Ambient Temperature (°C)	5°C – 30°C			
Water Inlet Pressure (Bar)	1 - 8 (Bar)			
Voltage (V)	220-240V (50/60Hz)			
Sound level (db)	<60			

7.0 Installation

7.1 Mounting to Wall

Please ensure there is at least 220mm of clearance below the boiler to allow for filter changes, the location must be frost free.

 **The unit must be installed on a solid concrete / brick or other suitably robust wall, with appropriate fittings by a qualified fitter. The company does not accept any responsibility for the safety of any unit not installed in this way.**

1. Mark the position of the 2 mounting holes 300mm apart as shown in the diagram below.
2. Ensure the marked positions are level.
3. Drill the wall and insert suitable wall plugs and screws.
4. Fix the wall bracket from the accessory kit, using 4.5mm hole screws to boiler. The screw required is included and can be found in the base of the boiler.
5. Hang the boiler on the two top lugs and locate the third hole position.
6. Drill the wall and insert suitable a wall plug.
7. Fix the boiler to the wall using a suitable screw.

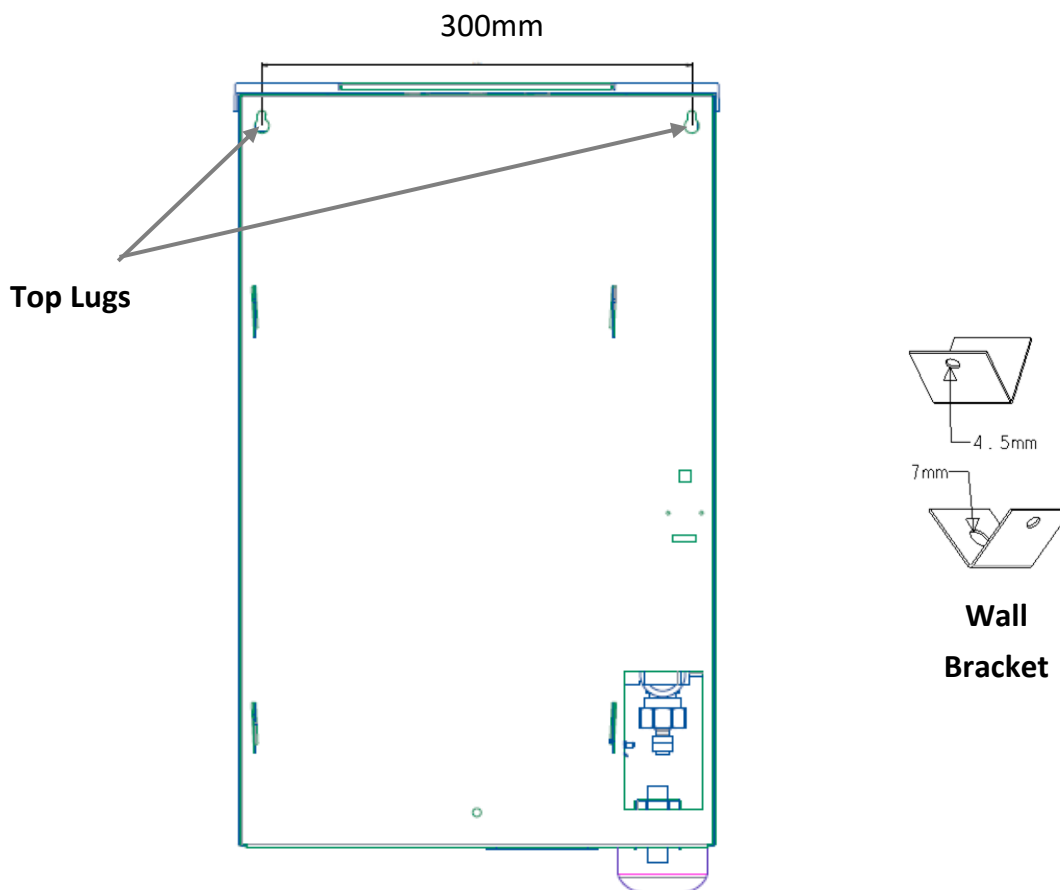



7.2 Before Connecting to the Power Supply

- Remove all packaging and plastic coating from the appliance.
- Check the unit has not been damaged in any way during transportation. Report any damage to the company who sold you the boiler right away.
- Check the available power supply corresponds to that shown on the rating label of the appliance, which must be A.C. (Alternating Current).
- **Ensure the yellow steam cap is removed from the steam vent prior to powering appliance.**

7.3 Connecting to the Water Supply

- Connection to the cold-water supply and the appliance should only be made by the hose supplied.
- In hard water areas, it is always advisable to fit an inline filtration unit to limit scale build-up. If you have purchased a Burco boiler that does not have a water filter system included, we recommend you fit a separate water filter between the boiler and the mains supply.
- Always ensure mains water supply is turned off, or localised isolation valves are closed before attempting to connect boiler to the mains water supply.
- The inlet water connection to the inlet solenoid valve is $\frac{3}{4}$ " BSP, this should be connected to the mains water supply via an accessible isolating tap.



Water Connection at Boiler

- The blue pipe at the bottom of the boiler connects to the grey fitting as shown in the image above.
- If not pre-plumbed, firmly push the blue pipe into the small outlet hole on the grey fitting.
- Ensure grey connection is screwed tight on the mains water supply and not leaking, forming a cold-water feed from the mains water supply to the Burco boiler.
- Do not use old water hoses.

7.4 Venting

- There is a possibility the steam vent may discharge hot or cold water and/or steam into the local vicinity of the boiler. If uncontrolled, steam or water damage may occur in this area. It is recommended that the vent on the base of the boiler is plumbed to a safe visible location.
- Please ensure that any building and/or water regulations are fully adhered to.

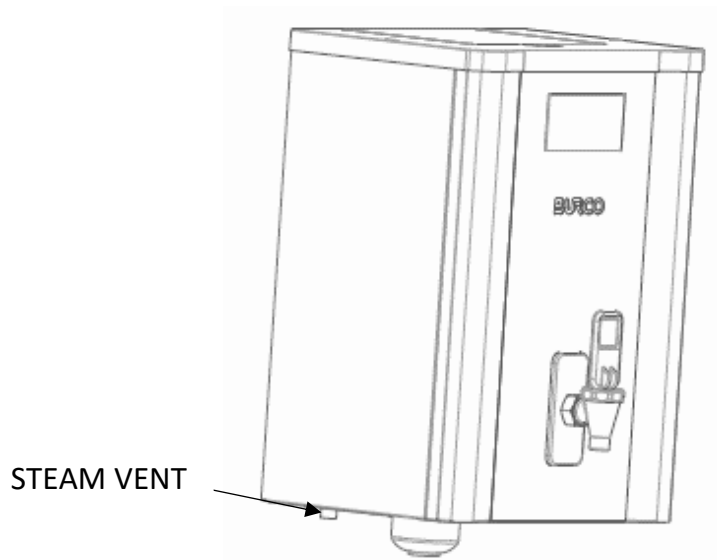

7.5 Electrical Connection

- All electrical work must comply with all relevant wiring regulations and carried out by a qualified electrician.
- To protect against fire, electric shock and personal injury, do not immerse cord, plug, or water boiler in water or any other liquid.
- If the supply cord is damaged, it should be replaced by the manufacturer, its service agent or similarly qualified persons in order to avoid hazard.



This appliance must be earthed.



The wires in the mains lead are coloured in accordance with the following code:

Wire Colour	Wire Name	Wire Code
Green & Yellow Wires	Earth	E
Blue Wire	Neutral	N
Brown Wire	Live	L

Means of isolation with at least 3mm contact separation in all poles must be incorporated into fixing of this appliance.

The fixed wiring insulation must be protected by insulated sleeving having a temperature rating of at least 60°C.

Supply cords should be oil resistant, sheathed flexible cable not lighter than ordinary polychloroprene or equivalent elastomer sheathed cord (code 60227 IEC 57).

The appliance is supplied with a terminal block suitable for flexible wires up to 6mm².

8.0 Overflow and Drainage

As an option, the boiler overflow outlet may be connected to a drainage system.



There may be some steam emitted from the vent at the base of the appliance during the initial fill stages (or if the tank is refilled after being fully emptied) but this will reduce as the volume of water increases in the tank. As an alternative, a flexible hose may be used to redirected steam to a sink/draining board.



The flexible hose connected from the over flow also acts as a vent for the appliance. Under no circumstances should this flexible hose become blocked or restricted in any way.

9.0 Operating Instructions

Burco boilers are designed for continuous operation and should only be switched off for the purpose of maintenance or emergency.

9.1 Boiler Overview



This product is supplied with a power cord. Connection to electrical outlet is required and should be carried out by qualified personnel to the appropriate standards. Appliance not available with a standard 13Amp UK 3 pin plug.

9.2 Controller Overview

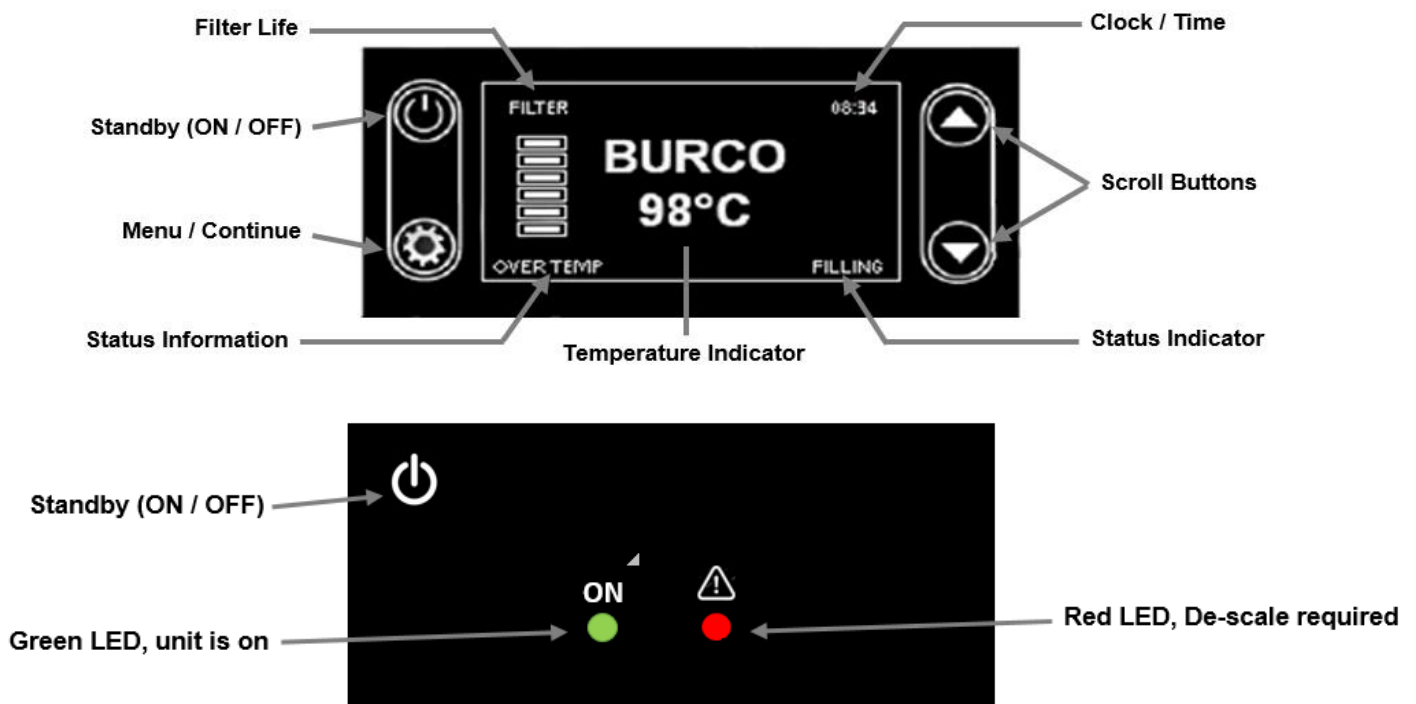

Before general use, please follow these important commissioning steps:

- Ensure boiler is connected to the mains water supply.
- Turn on the mains power and press and hold the power button  for 10 seconds. The boiler should begin filling and heating.
- Ensure boiler is set to 98°C, fully drain the boiler contents from the tap and repeat. **Boiler should be fully drained twice before general use.**

9.3 Controller Set Up

Touch Screen Display (Filtered Models Only):

The LCD screen will illuminate with the Burco logo. The default temperature and the time will flash waiting to be set. The hour figure will flash. Use the scroll buttons and press MENU to set when the correct time is shown. To change default temperature, press UP/DOWN SCROLL buttons to adjust to required temp.



Touch Screen Safety Lock:

Pressing and holding both the MENU and the UP-SCROLL button for 3 seconds activates the screen lock function. When the Screen Lock function is active settings cannot be changed. Press and hold the same buttons to deactivate the screen lock function. If in locked mode, the lock logo will blink on the screen for a couple of seconds if any button is pressed.



Set Time:

Press MENU SET CLOCK will be highlighted. Press MENU to enter the SET CLOCK menu. The time will be displayed, and the hour value will be flashing. Use the SCROLL buttons to select the correct value then press MENU. The minute values will now be flashing. Use the SCROLL buttons again to select the correct values. To store the time press MENU button again, this will also take you back to the SET UP menu. To exit the SET UP menu, press the STANDBY button.

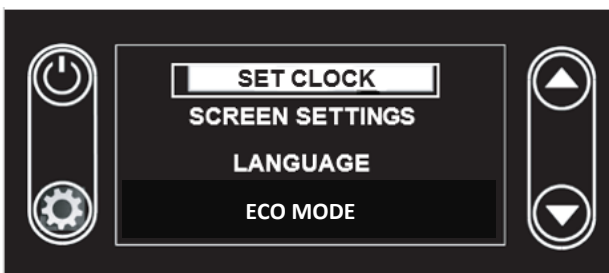

Set Temperature:

Use the UP and DOWN buttons to adjust the temperature. Press and hold the UP or Down button for 3 seconds before setting desired temperature.

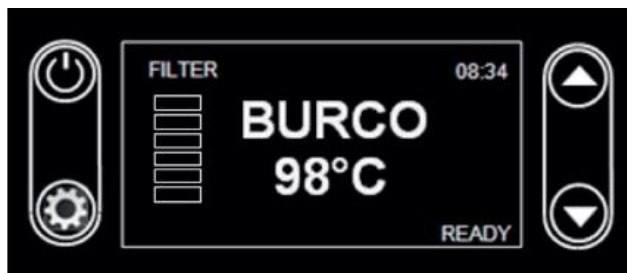

Screen Settings:

Press MENU and navigate down using the SCROLL button until SCREEN SETTINGS is highlighted, and then press MENU. For the backlight brightness, the values will flash. Use the SCROLL buttons to choose between 5 levels of backlight brightness. Hold MENU to store. Now the contrast values will flash. Repeat for the contrast. Hold MENU to store and to exit.

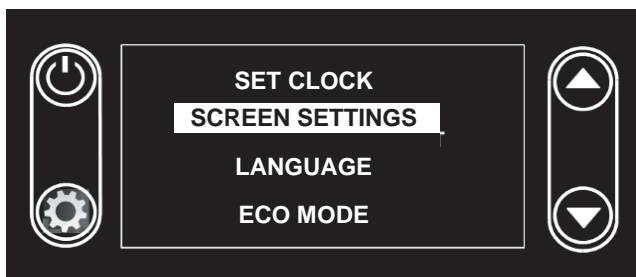

Language:

Press MENU and navigate down using the SCROLL button until LANGUAGE is highlighted, then press MENU. Scroll down to which language you want. Hold MENU to store and exit. Luxembourgish can also be selected in this menu.

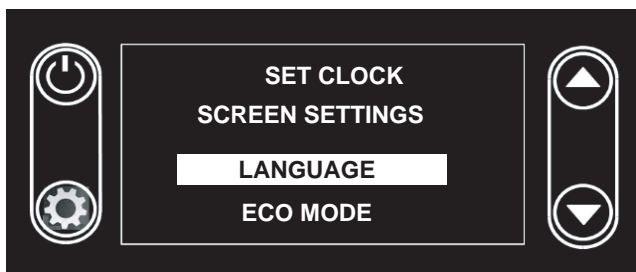

Eco Mode (Filtered Models Only):

When no water is drawn from the boiler in 2 hours, the eco mode is engaged. The backlight turns off and the only data displayed is the Burco logo along with the time and the status indicator. Water should be drawn off to resume normal operation. To set the Eco mode timer, simply scroll down to 'ON' to set the desired time. Once you are happy with the time that has been set, press the menu button to confirm this. This will then take you to 'OFF', where you can then set the time that you want the Eco mode to finish. If you want to turn the Eco mode off altogether, simply scroll down and select 'OFF'.

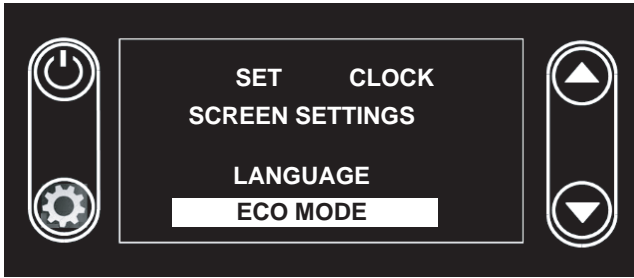

TO EXIT MENUS, PRESS THE STANDBY BUTTON



Heating Up:

HEATING will flash on controller screen during the heating up period. LOW TEMP may be shown on the screen during this time. When selected temperature is achieved – READY is shown.



Filling:

Once the INITIAL SET UP is complete, the filling process will start. The LCD Screen will show the word FILLING. After the filling is complete, the heating will start until it reaches the set temperature. The LCD Screen will show the word HEATING.



Filter Life (Filtered Models Only):

During operation, the bars fill to represent filter usage. Once exhausted, all the bars are solid and the fault code for changing the filter is displayed. The unit should be powered down. Filters replaced and filter counter reset (refer to replacement parts).

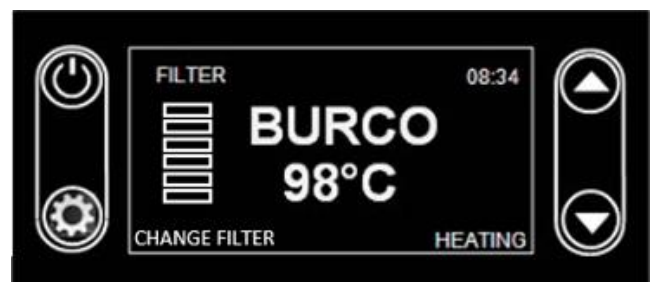

Power Down:

To power down the product, the STANDBY button should be held when on the normal operation screen for 10 seconds. The shutdown screen will appear and using the scroll buttons, 'Yes' should be selected by pressing MENU. The unit will then shutdown.

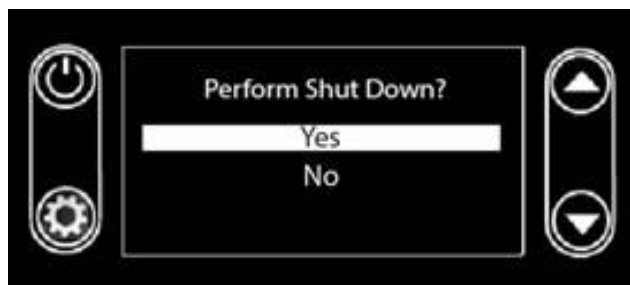

Tap Function:

The tap can be changed between a controllable and constant flow. For 'Controllable' flow, simply pull the plastic handle towards from you to dispense water and release to stop, see image 1. If you turn the plastic tap handle through 180 degrees, the tap will be in 'Constant' mode, see image 2. Now when you pull the tap towards you, it will remain locked downwards in an 'open' state until you lift the black handle back upwards to stop. The tap function is the same on tap models on both our Filtered and Unfiltered boilers.



1.



2.



Always take care when operating the tap as the water will be boiling hot.

10.0 Cleaning and Descaling Advice and Information

10.1 Descaling

The descaling procedure must be performed by suitable personnel as it requires the removal of panels from the boiler and access to live electrical components.



Always use a descaling agent suitable for stainless steel.

1. Isolate the boiler from electrical supply.
2. Allow the water to cool to approximately 60°C
3. Lift-up the lid on the top of the boiler (Picture 1).
4. Twist the black tank cap **clockwise** and remove it. (Picture 2)
5. Add descaling agent through opening (Picture 3) in accordance with manufacturer's instructions.
6. Replace the black tank cap (**anti-clockwise**) and ensure it is secure.
7. Turn on the electricity and allow the boiler to operate normally for approximately 45 minutes.
8. Isolate / turn off the boiler and allow to cool down.
9. Remove the tank cap again, to inspect the tank and level detectors for scale deposits.
10. Drain and flush the de-scaling agent from the tank, using tap on the front of the appliance.
11. To drain the tank completely, remove panel under appliance (picture 4), locate the drain valve (picture 5) & attach overflow pipe (picture 6)
12. Connect a hose from the overflow pipe into a bucket and open the valve to drain the tank.
13. When empty, close the valve and replace panel removed in step 12.
14. Replace tank cap and lid.
15. Turn the boiler back on.



1



2



3



4



5

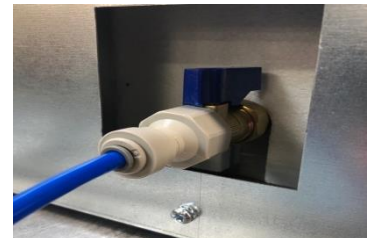

6

It is important that you descale your water boiler regularly, particularly in hard water areas.

❗ Failure to descale your water boiler or replace your filter cartridge when prompted to do so will invalidate your warranty.

11.0 Changing Water Filter (Filtered Models Only).

❗ The filter must be installed for the product to function for filtered models

The boiler will alert when a new filter cartridge is required. The boiler should be descaled in conjunction with the filter change, see page 14 of instructions.



❗ The water filter cartridge is unique to Burco. Only Burco “BC02” replacement filter (Part No. 01/74334/0) will fit these models. Please either purchase a replacement from your catering equipment supplier, or alternatively order replacements via: ☎+44 [0]344 879 3588 (UK) or +353(0)1 842 833 (ROI)  www.burco.co.uk



1. Locate the filter below the boiler.



2. Twist cartridge anticlockwise & remove. (residual water may be present)



3. Remove all film and packing, insert new filter cartridge.



4. Twist the cartridge clockwise until locked in position.



5. To reset filter timer, PRESS & HOLD the UP & DOWN buttons until you hear a beep.



Failure to use the correct filter cartridge will affect performance and invalidate the boilers warranty.

12.0 Cleaning Instructions

It is recommended that your water boiler is cleaned on a regular basis. Failure to do so may result in the appliance not operating to its full potential and may invalidate your warranty.



Disconnect from the electrical supply before cleaning and allow water boiler to cool. Do not immerse the water boiler in water or any other liquids and take care to keep water away from the supply cord and connections. Do not use a water jet or steam cleaner.

External Cleaning

Wipe the external surfaces & dispensing tap of the appliance with a damp cloth. It is recommended that this is done daily to prevent lime scale build up. Stubborn stains may be removed using a good stainless-steel cleaner or non-abrasive cleaner. Hard to reach areas should be cleaned using a soft brush & mild cleaning solution.



Failure to clean on a regular basis may invalidate your warranty.

13.0 Troubleshooting

If you experience any problems with the water boiler, please contact our Aftersales team on +44 [0]344 879 3588 (UK) or +353(0)1 842 833 (ROI). To ensure we can offer you the best possible service, please ensure you have the product code and serial number available (from page 2).

Your boiler is fitted with a fault system that can detect fault conditions. Some of the conditions are less serious and the boiler will continue to operate normally, while other faults are more serious and will disable the appliance. Before calling the service line, switch off appliance at the main supply, then draw off a small amount of water and switch back on after 10 minutes. If the fault continues, please call the service line for advice on **+44 [0]344 879 3588 (UK) or +353(0)1 842 833 (ROI)**

QR codes that appear on the screen can be scanned using an iPhone, Android and Windows device, which will take you to the Burco website.

If you believe your Burco Boiler isn't working correctly, please contact our Aftersales Team on +44 [0]344 879 3588 (UK) or +353(0)1 842 833 (ROI)

14.0 Disposal

At the end of the appliance's useful life, it should not be disposed of with household waste. Please recycle where facilities exist. Check with your local authority for recycling facilities and advice in your area.



For electrical products sold within the European Community. At the end of the electrical products useful life it should not be disposed of with household waste. Please recycle where facilities exist. Check with a Local Authority or retailer for recycling advice in your country. Batteries should be disposed of or recycled in accordance with WEEE Directive 2012/19/EU (ROI) or in accordance to The Waste Electrical and Electronic Equipment Regulations 2013 (UK). Packaging should be recycled where possible.

15.0 Spare / Replacement Parts



Genuine replacement Burco parts must be fitted. If generic non-Burco parts are fitted, you may prevent your appliance from operating safely and in the most efficient manner and invalidate your warranty.

Spare PN	Description	069801	069818	069924	069931
SP04/19668/0	VALVE solenoid 3/4" BSP R90884	SP04/19668/0	SP04/19668/0	SP04/19668/0	SP04/19668/0
SP083211800	ADAPTOR 3/4-1/4 JG C1320816S	SP083211800	SP083211800	SP083211800	SP083211800
SP083297800	SWITCH L95C thermal cut out	SP083297800	SP083297800	SP083297800	SP083297800
SP04/19669/0	ELEMENT 3KW CT	SP04/19670/0	SP04/19670/0	SP04/19670/0	SP04/19670/0
SP083616100	SWITCH thermal L130 MR (16Amp)	SP083616100	SP083616100	SP083616100	SP083616100
SP01/74339/0	SEAL TANK CT / WM	SP083388800	SP083388800	SP083388800	SP083388800
SP01/74370/0	LID TANK CT / WM (SELF)	SP01/74379/0	SP01/74379/0	SP01/74379/0	SP01/74379/0
SP03/23761/0	CAP TANK ACCESS	SP03/23761/0	SP03/23761/0	SP03/23761/0	SP03/23761/0
SP100000012	TUBE 1/4LLDPE PE-08-BI-0500F-	SP100000012	SP100000012	SP100000012	SP100000012
SP01/74354/0	SURROUND TAP	SP01/74354/0	SP01/74354/0	SP01/74354/0	SP01/74354/0
SP01/74335/0	TAP DISPENSE CHROME #1026039	SP01/74335/0	SP01/74335/0	SP01/74336/0	SP01/74336/0
SP03/23765/0	CONTROLLER 3KW ADV	SP03/23765/0	SP03/23765/0	SP083634400	SP083634400
See across	PANEL FRONT FORMED	SP04/19676/0	SP04/19675/0	SP21/74526/0	SP21/74527/0
SP01/74351/0	LID FIXED	SP01/74352/0	SP01/74352/0	SP01/74352/0	SP01/74352/0
SP01/74353/0	LID LIFT OFF	SP01/74515/0	SP01/74515/0	SP01/74515/0	SP01/74515/0
SP01/74429/0	HEAD FILTER H2O	SP01/74429/0	SP01/74429/0	N/A	N/A
SP01/74334/0	CARTIDGE FILTER H2O	SP01/74334/0	SP01/74334/0	N/A	N/A
SP083211900	ELBOW 1/4 stem JG P1220808S	SP083211900	SP083211900	SP083211900	SP083211900
SP083632501	SENSOR assy upper AF	SP083632506	SP083632501	SP083632501	SP083632501
SP083632500	SENSOR assy descale AF	SP083632500	SP083632500	SP083632500	SP083632500
See across	SENSOR assy low	SP083632504	SP083632504	SP083632505	SP083632504
SP083212000	ELBOW 3/8-1/4 JG P1211208S	SP083212000	SP083212000	SP083212000	SP083212000
SP59042	HEAT SINK COMPOUND	SP59042	SP59042	SP59042	SP59042

Master File SM 027 REV 01

For further information or to purchase spare parts, please contact our Aftersales team on +44 [0]344 879 3588(UK) or +353(0)1 842 833 (ROI). Please ensure you have the details of the model and serial numbers to hand. These can be found in the "About my product" section on page 2. These can also be found on the data label at on the back of the appliance

16.0 Frequently Asked Questions (FAQ's).

The following list of FAQs' may help you with any information or problems with your Burco boiler. Alternatively, please contact our Aftersales Team on +44 [0]344 879 3588(UK) or +353(0)1 842 833 (ROI) if your question is not covered below or if you aren't sure about something.

Q. Are there any restrictions as to where I should locate my Burco water boiler?

A. Yes, your appliance should be positioned on a flat, vertical wall that can take the weight of the appliance when full of water. Consideration must also be given to servicing requirements and safe operational access to the appliance must also be ensured. For a detailed overview of installation requirements, please refer to page 7 of this instruction book.

Q. There is no water coming from the tap?

A. Check that the appliance is connected to mains power/water and that there is no blockage/kink in the supply hose.

Q. My screen is not illuminating?

A. Check the appliance is connected to mains power and turned on then adjust the brightness/contrast setting if required.

Q. My boiler displays 'CHANGE FILTER'?

A. Replace filter and reset the filter counter. If you need further help, please contact our Aftersales Team on +44 [0]344 879 3588.

Q. The water from the tap is cold?

A. Check appliance is connected to mains power and set temperature at the desired setting.

Q. The water in my appliance has a strange taste?

A. All new appliances must be heated and drained to sanitise. Follow the instructions outlined on page 12 to complete this process.

Q. What warranty does my water boiler have?

A. Your Burco boiler will come with a 1-year parts and labour warranty. If you have purchased a boiler with a water filter, it will come with a 2 years parts and labour warranty. Please see the 'Warranty' section on page 6 for details.

Q. My boiler doesn't seem to be heating what is wrong with it?

It could be that your boiler requires descaling. Follow the instructions on page 16 to do this. **Regular descaling is the responsibility of the site.** If the boiler has not been descaled when our Service Engineer visits, the service call will be chargeable.

Q. Can I purchase any replacement parts?

A. Yes, we have a number of replacement parts available. If you require any spare parts, please do not hesitate to contact our Aftersales Team on +44 [0]344 879 3588(UK) or +353(0)1 842 833 (ROI) and they will be happy to assist.

17.0 Warranty Information

What does a Burco Warranty Cover?

Burco products deliver reliable service for normal, household use in domestic settings. All Burco products are individually tested before leaving the factory.

If you are a consumer and you experience a problem with your Burco product, which is found to be defective due to faulty materials or workmanship within the Warranty Period, this Burco Warranty will cover repair or - at the discretion of Burco – replacement with a functionally equivalent Burco product.

The Burco Warranty Period is two calendar years from the date of purchase of your Burco product, or the date of delivery of the product, if later. The Burco Warranty is conditional upon you providing the original purchase receipt as proof of purchase. Please therefore retain your receipt as proof of purchase.

If you do experience a problem with your Burco product, please call the Helpline on **+44 [0]344 879 3588** or visit **<https://www.dimplex.co.uk/support>**. For ROI please email **serviceireland@glendimplex.com** or call **+353(0)1 842 833**. We will need details of your Burco product, its serial number and a description of the fault which has occurred. You can find the model number and serial number for your Burco product on the heaters side. Once we receive your information and proof of purchase, we will contact you to make the necessary arrangements.

If your Burco product is not covered by this Burco Warranty there may be a charge to repair your product. However, we will contact you for agreement to any charges before any chargeable service is carried out.

What is *NOT* Covered by a Burco Warranty?

The Burco Warranty does not cover any of the following:

- Any fault or damage to your Burco product due to faulty materials or workmanship occurring outside the two-year Warranty Period.
- Any fault or damage occurring to any pre-owned Burco product or to any other equipment or property.
- Accidental damage to your Burco product or damage to your Burco product from external sources (for example, transit, weather, electrical outages or power surges).

Fault or damage to your Burco product which is:

- Not due to faulty materials or workmanship or which is due to circumstances outside Burco's control.
- Caused by use of your Burco product for anything other than normal domestic household purposes in the country where it was purchased.

- Caused by any misuse, abuse or negligent use of the Burco product, including but not limited to any failure to use it in accordance with the Operating Instructions supplied with the product.
- Caused by any failure to assemble, install, clean and maintain your Burco product in accordance with the Operating Instructions supplied with the product unless this was carried out by Burco or its authorised dealers.
- Caused by repairs or alterations to your Burco product not carried out by Burco service personnel or its authorised dealer(s).
- Caused by use of any consumables or spare parts for your Burco product which are not Burco -specified.

18.0 Terms and Conditions

- The Burco Warranty is valid from Burco from the date of purchase of your Burco product from a recognised retailer in the country of purchase and use, or the date of delivery of the product if later, always provided the original receipt has been retained and is produced as proof of purchase.
- You must provide to Burco or its authorised agents on request the original receipt as proof of purchase and - if required by Burco - proof of delivery. If you are unable to provide this documentation, you will be required to pay for any repair work required.
- Any repair work under the Burco Warranty will be carried out by Burco or its authorised dealer(s) and any parts that are replaced will become the property of Burco. Any repairs performed under the Burco Warranty will not extend the Warranty Period.
- Any replacement of your Burco product by Burco during the Warranty Period will start the two-year Warranty Period afresh from the date of delivery of the replacement Burco product to you.
- The Burco Warranty does not entitle you to recovery of any indirect or consequential loss or damage including but not limited to loss or damage to any other property.
- The Burco Warranty is in addition to your statutory rights as a consumer and your statutory rights are not affected by this Burco Warranty.

Contact Burco

If you have any questions about what the Burco Warranty covers and does not cover or how to claim under the Burco Warranty, please contact us using the information on the back page.

Contact Details

Glen Dimplex UK LTD. (UK Customers)

Millbrook House, Grange Drive, Hedge End, Southampton, SO30 2DF

Glen Dimplex Europe Limited (ROI Customers)

Airport Road, Cloghran, Co. Dublin, K67 VE08, Ireland

Disregarding the instructions given in this manual in its entirety and any relevant regulations, standards and code of practice will void the guarantee of this product. Glen Dimplex reserve the right to revise products, literature and guarantee terms without prior notice due to a policy of continuous improvement

To speak to customer services please contact (UK & ROI):

Glen Dimplex UK LTD.

Millbrook House Grange Drive, Hedge End,

Southampton, SO30 2DF

Telephone: +44 [0]344 879 3588

Fax: 0844 879 3583

Email: customer.services@glendimplex.com

Or

Glen Dimplex Europe Limited

Airport Road, Cloghran,

Co. Dublin, K67 VE08, Ireland

Telephone: +353(0)1 842 833

Email: serviceireland@glendimplex.com

