



Swan Retro

designed for life



Swan Espresso Coffee Machine

Model: SK22110 (all colours)

Help line: **0333 220 6050**

Hints, tips & videos

www.swan-brand.co.uk/coffee

v1.1



IMPORTANT INFORMATION - RETAIN FOR FUTURE USE

When using any electrical appliance, basic safety precautions should always be followed including the following:

- Always ensure that the voltage on the rating label corresponds to the mains voltage in your home
- Incorrect operation and improper use can damage the appliance and cause injury to the user.
- This appliance can be used by children aged from 8 years and above if they have been given supervision or instruction concerning use of the appliance in a safe way and if they understand the hazards involved. Cleaning and user maintenance shall not be made by children unless they are older than 8 and supervised. Keep the appliance and its cord out of reach of children aged less than 8 years. Check the power cord and plug regularly for any damage. If the cord or the plug is damaged, it must be replaced by the manufacturer or qualified person in order to avoid an electrical hazard.
- Do not use the appliance if it has been dropped or damaged in any way. In case of damage, take the unit in for examination and/or repair by an authorised service agent.
- Never immerse the unit in water or any other liquid for cleaning purposes.
- Remove the plug from the socket by gripping the plug. Do not pull on the cord to disconnect the appliance from the mains. Always unplug the unit when not in use, before cleaning or when adding or removing parts.
- The use of accessory attachments that are not recommended or supplied by the manufacturer may result in injuries, fire or electric shock.





IMPORTANT INFORMATION - RETAIN FOR FUTURE USE

- Do not let the cord hang over the edge of a table or counter. Ensure that the cord is not in a position where it can be pulled on inadvertently.
- Do not allow the cord to touch hot surfaces and do not place on or near a hot gas or electric burner or in a heated oven.
- Do not use the appliance on a gas or electric cooking top or over or near an open flame.
- Use of an extension cord with this appliance is not recommended. However, if it is necessary to use an extension lead, ensure that the lead is suited to the power consumption of the appliance to avoid overheating of extension cord, appliance or plug point. Do not place the extension cord in a position where it can be pulled on by children or animals or tripped over.
- This appliance is not suitable for outdoor use. Do not use the appliance for anything other than its intended use.
- Do not carry the appliance by the power cord.
- Do not leave the appliance unattended during use. Always unplug the unit when not in use or before cleaning.
- Always operate the appliance on a smooth, even, stable surface. Do not place the unit on or near a hot surface.
- Ensure that the unit is switched off after use.
- The manufacturer does not accept responsibility for any damage or injury caused by improper or incorrect use, or for repairs carried out by unauthorised personnel.
- In case of technical problems, switch off the product and do not attempt to repair it yourself. Return the appliance to an authorised service facility for examination, adjustment or repair. Always insist on the use of original spare parts.





IMPORTANT INFORMATION - RETAIN FOR FUTURE USE

Failure to comply with the above mentions precautions and instructions, could affect the safe operation of this product.

- Your appliance must never be switched on through an external timer or any kind of separate remote control system
- Do not operate the product without water
- This appliance is intended to be used in household and similar applications such as staff kitchen areas shops, offices and other working environments, farm houses, by clients in hotels, motels and other residential type environments, bed and breakfast type environments.
- Do not use outdoors.

DO NOT OVERFILL THE WATER TANK PAST THE MAX LEVEL. DOING SO POSES A SCALDING, ELECTRIC SHOCK OR FIRE RISK.



TECHNICAL DATA

Description: Espresso Coffee Machine

Model: SK22110 (all colours)

Input Voltage: 220-240V

Frequency: 50Hz

Power consumption: 1100 Watts



WARNING

HOT SURFACES



INTRODUCTION

Beat the Daily Grind with our at home Barista Guide

The sweet scent of that first cup in the morning can melt all resistance to the day ahead and bring life to the sleep heavy limbs of any early morning riser. Coffee is truly man's best friend and as we launch our stylish and chic Retro Coffee Maker, we have some ways you can make the most of your coffee.

Keeping it Simple with Espresso

Perhaps ex-presso would be a better name, the espresso is favoured by the Italians for its quick hit and strong flavour. The espresso is coffee, simply. For a lighter caffeine hit a single shot of coffee will do, add a little water and, hey presto! An espresso is ready to spur you into the day ahead, or the night if you have big plans. If you need a little extra umph, add a second shot of coffee to feel the buzz last longer.

Hombre, Hombre, Americano!

Some might call this simply, a black coffee. However, the Americano is Barista for a delicious steaming cup of Joe. 2/3 hot water and 1/3 espresso, this drink can be prepared using an espresso machine or the humble cafetiere. Hold that burning hot pot! If you're using a cafeteria, in order not to boil the nutty tones of this beverage, allow the boiled water five minutes to cool before pouring over your cool beans. Leave to brew for another three to five minutes and then, pour.

Never too Late for a Latte

The latte has evolved into a drink with so many opportunities for flavour it's almost overwhelming. Chai Latte, Caramel Latte, Vanilla Latte... heads have been known to spin right off in confusion on arriving at the local coffee shop, so struck by the numerous options available for this single drink. To keep things simple, it requires only one or two shots of water filtered coffee, and the addition of thinly foamed milk to create the original Café Latte.

Cap it off with a Cappuccino

A regular after dinner feature the cappuccino is a smooth and milky delight. A single shot of coffee first and then, the frothy top! Add approximately 6oz of milk to your metal jug and steam until the milk begins to swirl and has a delightful frothy appearance. Pour this into your shot of espresso and foam ahoy! Your cappuccino is ready. If you have a sweet tooth, sprinkle a light coating of chocolate powder or cinnamon on top.





INTRODUCTION

The Unfathomable Flat White

White as a midnight Spector, mysterious as the lady of the lake. It seems that the Flat White-delicious, milky and maddening has become a talking point as nobody seems to know quite what it is. Well, mystery solved! One shot of espresso and the addition of very thin, ever so lightly steamed milk and what we have is the simply solved Flat White. I think we can all agree that the mystery was rather elementary, dear Watson.

Mix it up with a Mocha

Craving a little luxury? Need the caffeine hit but looking for a sweet fix as well? The mocha is a magical blend of coffee's enriching sustenance and chocolate's sweet seductive flavours. Add one shot of espresso to your favourite mug and a table-spoon or two of your favourite hot chocolate drink. Steam your milk until it's hot and smooth with a slight foam before adding it to your coffee-chocolate mix. Stir your potion until it's a mug of silky perfection. Indulge.

Have you been crafting some coffee magic in the kitchen? Share your favourite coffee brewing tips with us on social media so we can enjoy the perfect cappuccino, together. @swanbranduk



SAFETY TIPS

- Do not touch the hot surface of appliance (such as steam wand, and the coffee filter just after boiling). Use handle or knobs.
- Do not let the coffee maker operate without water.
- DO NOT remove the porta-filter while brewing coffee.
- Only remove the porta-filter to make additional coffee after at least 10 seconds.
- Caution should also be taken while removing the porta-filter since the metal parts will be hot. Please make sure to hold it by the handle and to use the filter retention clip to dispose the grounds.
- Caution should be used when moving unit with hot liquids.



AN INTERLUDE

This is so important, we have dedicated an entire page to it!

- Have a quick look inside your kettle
- Is there any lime scale in it?
- If there is then you need to use bottled water in this appliance because lime scale will clog the precision engineered parts and break it.
- If there isn't any lime scale and you never need to de-scale your kettle then you're probably OK with tap water.





GETTING TO KNOW YOUR ESPRESSO MACHINE

MAIN PARTS

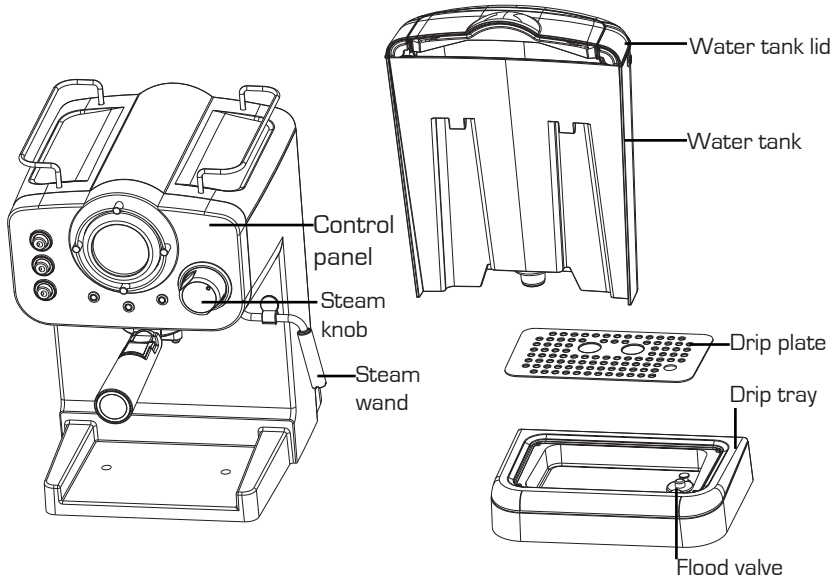

CONTROL PANEL

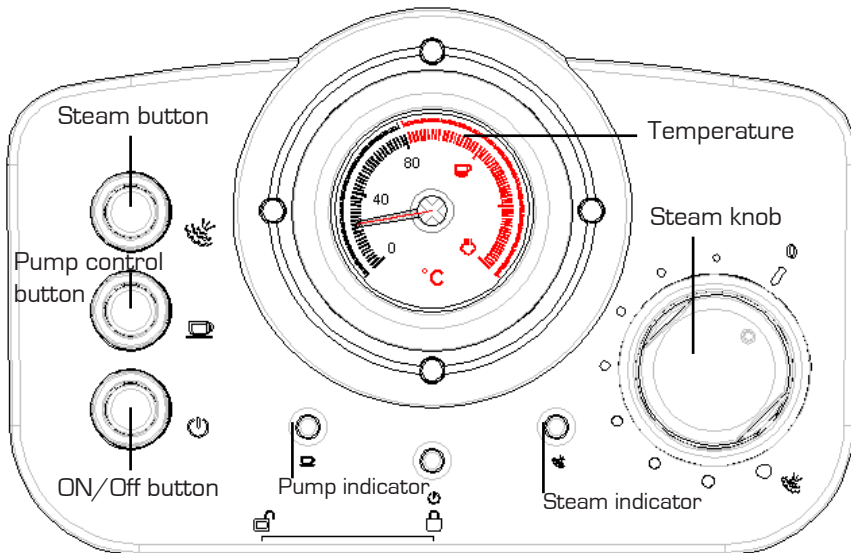



HOW TO USE

INSERTING THE FILTER

To insert the selected filter in the porta-filter, make sure to align the notch on the filter with the groove inside the porta-filter.

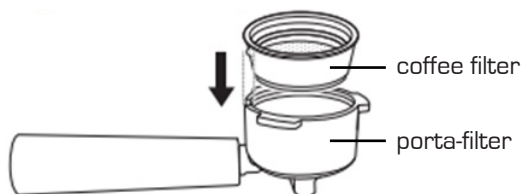

Turn the filter to the left or right to lock in place. This will help secure the filter in the porta-filter. There are two coffee filters: shallow (single shot) and deep (double shot).

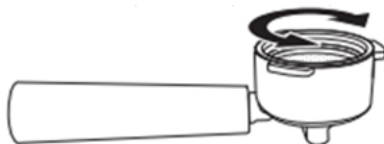

BEFORE THE FIRST USE

Remove all packaging. Make sure the steam knob is at 0 and the steam button, pump control button and On/Off button are in the OFF (out) position.

To ensure the first cup of coffee tastes excellent, you should rinse the coffee maker with warm water as follows:

- Pull out the water tank of the coffee maker. Pour water into the tank. Do not fill past the MAX level. Insert the tank back into the coffee maker.
- Set coffee filter into porta-filter (no coffee in coffee filter), then put it into the dock (see Fig.1), and turn it anti-clockwise until it is fixed tightly (see Fig.2 and Fig.3).

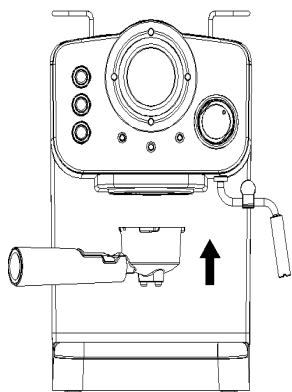

fig.1

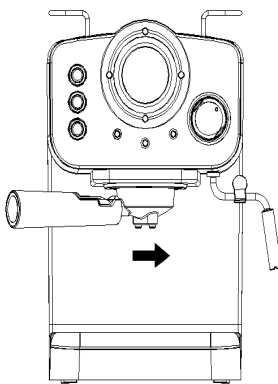

fig.2

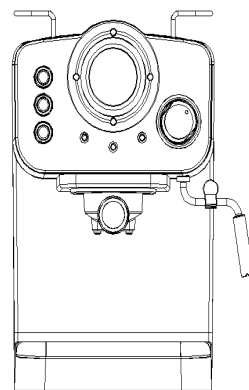







fig.3









HOW TO USE

- Place an espresso cup you have prepared on to the drip plate. Make sure the steam knob is at the “O” position.
- Connect into power source, press down the ON/OFF button  to turn on the unit. The power indicator (red) will be illuminated.
- Press down the pump control button , the pump will pump water. When there is water flowing out close the pump by pressing the pump control button  again.
- Make sure the steam button  is in the OUT position and wait for a moment. The appliance will begin preheating until the coffee indicator (green) illuminates. This means that the preheating is finished.
- Press down the pump control button  again, and water will flow out.
- After water has flowed for 1 minute, press the pump control button , you can pour out the water in each container then clean them thoroughly, now you can start brewing coffee.
- Note: There may be noise when pumping the water for the first time. This is normal, as the appliance is releasing the air in the system. After about 20 seconds, the noise will disappear.

PREHEATING

To make a cup of good hot Espresso coffee, it is recommended to preheat the appliance before making coffee, including the funnel and cup, so that the coffee flavour will not be influenced by the cold parts.

- Remove the removable water tank and fill it with desired water, the water level should be between the “MAX” mark and the “MIN” mark in the tank. Then insert the tank into the appliance properly.
- Set coffee filter into porta-filter (no coffee in coffee filter), then put the porta-filter under the porta-filter dock (see Fig.1), and turn it anti-clockwise until it is fixed tightly (see Fig.2 and Fig.3).
- Place an espresso cup you have prepared on removable cup shelf.
- Connect the appliance to power supply. Make sure the steam knob is at the “O” position.
- Press the ON/OFF button  to turn on the unit, the power indicator (red) will illuminate, make sure the steam button  is in the OUT position.
- Press down the pump control button  to the lower position. When there is water flowing out, close the pump immediately by pressing the pump control button  again to the OUT position. The purpose of the step is to pump the water from the tank into the housing.
- When the coffee indicator (green) is illuminated, and you should press down the pump control button  again, there will be hot water flowing out.









HOW TO USE

- After water has flowed for 20 seconds, press the pump control button  to the OUT position. The preheating is finished.

MAKE ESPRESSO COFFEE

- Remove the porta-filter by turning it clockwise.
- Add ground coffee to coffee filter with measuring spoon, a ground coffee powder can make about a cup of top-grade coffee, then press the ground coffee powder tightly with the tamper. Use shallow coffee filter for single shot or deep coffee filter for double shot.
- Set coffee filter into porta-filter, then put the porta-filter under the dock (see Fig.1), and turn it anti-clockwise until it is fixed tightly (see Fig.2 and Fig.3).
- Pour out the hot water in the cup. Then place your hot cup on removable cup shelf.
- Make sure the steam knob is at the "0" position and the steam button  is in the OUT position.
- Once the green lamp illuminates, press down the pump control button  to the lower position, wait for a moment, there will be coffee flowing out.
- You should press and release the pump control button  to the OUT position manually when desired coffee is obtained or the colour of coffee changes to a lighter colour - indicating it is weak.
- After finishing making coffee, press the ON/OFF button . The power indicator and coffee indicator will go out and the coffee maker will stop working. Your coffee is ready now.
- **WARNING:** do not leave the coffee maker unattended during making coffee, as you need to operate it manually sometimes!
- **Note:** During brewing coffee or making steam, it is normal for the ready indicator to go out. It only means that the heater is heating up to keep the temperature at the standard range.
- You can take the porta-filter out by turning clockwise, then pour the coffee residue out with the coffee filter pressed by pressing the bar.
- Let them cool down completely, then rinse under running water.





HOW TO USE

MAKE CAPPUCCINO

You can get a cup of cappuccino by topping a cup of espresso with frothed milk.

Note: during making steam, the porta-filter must be in position.





Method:

- Prepare espresso as detailed above in "MAKE ESPRESSO COFFEE". Make sure the cup is big enough to accommodate the coffee and the frothed milk. Also make sure that the steam knob is at the "0" position.
- Press down the steam button  to the lower position, until the steam indicator (yellow) illuminates.
- Fill a jug with about 100 ml of milk for each cappuccino to be prepared, you are recommended to use whole milk at refrigerator temperature (not hot).
- In order to get better milk foam performance, open steam knob for approximately 15 seconds without putting it in the milk yet. This will clear out any cold water in the system. Then put the knob back to "0" position and conduct the next step. **NOTE:** Often when the steamer is first used hot water will come out when turned on. Make sure a cup or some paper is put down to catch any water.
- Insert the steam wand into the milk about two centimetres deep, then turn the steam knob **slowly** anti-clockwise. Steam will come out from the steam wand. **For Latte:** the Milk needs to be smooth and milky, when pouring start from high and work down as the cup is being filled. When the milk is nearly at the top of the cup go lower with the jug allowing the frothier milk come out. **For Cappuccino:** The milk needs to be frothy, pour on a side angle allowing the frothy milk into the cup. **Note: Never touch steam outlet during steam jetting and be careful not to get burnt.**
- **Note:** Always turn the steam knob slowly to release the steam in a controlled manner
- When frothing of the milk is complete, you can turn the steam knob back to the "0" position.
- Best temperature for frothed milk is 70 degrees C. There will be plenty of steam coming from it.
- After frothing the milk, put an empty jug under the steam wand, then turn on the steam knob and press down the pump control button  to the lower position, for 30 seconds, then turn it off again. This will clean out the steam tube. Finally, clean the steam outlet with wet sponge, but take care not to get burnt!
- Press and release the ON/OFF button  to switch the machine off.
- Pour the frothed milk into the espresso prepared, now the cappuccino is ready. Sweeten if desired and sprinkle the froth with a little cocoa powder.









HOW TO USE

- **Note:** If the steam outlet becomes blocked: Turn the steam knob to “O” position and allow the coffee maker cool down for about half an hour, then poke the steam outlet several times with a needle about 1 mm in diameter until it clears.
- Finally, press down the steam button  and turn on the steam knob to check if the appliance can produce steam normally when the steam indicator (yellow) illuminates. Please contact the service department if the appliance can not produce steam after performing the above operation
- **Please see the section below about lime scale. It can seriously damage the machine if steps are not taken to mitigate it.**
- Note: after steaming, we recommend you allow the machine to cool down for at least for 5 mins before making coffee again. Otherwise a burnt odour may manifest itself in your Espresso coffee.
- If you want to make more coffee immediately press and release the steam button  to the OUT position; dip the steam wand into a cup, Press the pump control button  down to the lower position and turn on the steam control knob and there will be water flowing from steam wand ; after the ready indicator goes out, press and release the pump control button  to the OUT position, then turn the steam control knob to “O” position. When the ready indicator illuminates, you can start to brew coffee again.



FROTHING MILK/PRODUCING STEAM TO HEAT LIQUIDS

The steam wand can be used to froth milk and make hot beverages like drinking chocolate, water or tea.

- Remove the tank and fill it with required amount of water, the water level should not exceed the “MAX” mark in the tank. Then insert the tank on to the appliance.
- Connect the appliance to power supply and press down the ON/OFF button  to turn on the unit, the power indicator (red) illuminates.
- Press down the pump control button  to the lower position, make sure the steam button  is at the OUT position, the pump will pump water, when there is water flowing out, close the pump immediately.
- Press down the steam button  to the lower position and wait for a moment. The appliance begins to heat until the (yellow) lamp illuminates, it means the heating is finished.



HOW TO USE

- Dip the steam wand into the liquid to be heated. If you want to froth milk, dip the steam wand about 2 centimetres into the milk. Turn the steam knob in anti-clockwise slowly to start making steam.
- When you have finished turn the steam knob to the “0” position.
- After you finish frothing milk each time, put an empty jug under the steam band, then turn on the steam knob and press down the pump control button  to the lower position. Let the pump operate for 30 seconds, then turn it off again. Finally, clean the steam outlet with wet sponge, but take care not to get burnt!
- Press and release the ON/OFF button  to switch the machine off.
- **Note:** If the steam outlet becomes blocked: Turn the steam knob to “0” position and allow the coffee maker cool down for about half an hour, then poke the steam outlet several times with a needle about 1 mm in diameter until it clears. Clean any access coffee from under the filter using the coffee brush
- Finally, press down the steam button  and turn on the steam knob to check if the appliance can produce steam normally when the steam indicator (yellow) illuminates. Please contact the service department if the appliance can not produce steam after operate as above.
- Please see the section below about lime scale. It can seriously damage the machine if steps are not taken to mitigate it.

AUTOMATIC POWER OFF FUNCTION

The appliance will turn itself off automatically 29 minutes after pressing ON/OFF button.



HOW TO USE

LIME SCALE







When you heat tap water, calcium and other mineral deposits attach themselves to the inside of your coffee maker, kettle, iron, washing machine etc.

Excessive lime scale build up will damage your Espresso Coffee Machine. The steam tube is particularly vulnerable to lime scale blockage and should be cleaned regularly.

We recommend using pre-filtered or bottled water. If you cannot do this and use water straight from the tap then it will be necessary to de-scale the product regularly. There are plenty of good, inexpensive lime scale remedies available - including from Swan website.

HOW TO DE-SCALE

To ensure your coffee maker can operate efficiently the internal piping must be clean so as not to affect the flavour of the coffee. You should clean away the mineral deposits left every 4 weeks - if you live in a hard water area every 2 weeks. Better still, just use bottled water and none of this will be necessary!

- Fill the tank with water and descaler to the MAX level (the proportion of water and descaler is 4:1 or refer to the instruction of descaler. Please use "household descaler", you can use the citric acid (obtainable from chemist's or drug stores) instead of the descaler (one hundred parts of water and three parts of citric acid).
- Follow the steps as detailed in "PREHEATING" above.
- Press down the ON/OFF button  to turn on the unit, the power indicator (red) will be illuminated, you should press the pump control button  to the lower position, make sure the steam button  is at the OUT position, when there is water flowing out, close the pump by pressing the pump control button  again, and wait for a moment. The coffee maker begins to be heated.
- When the ready the green indicator illuminates, showing the heating is finished. Pressing down the pump control button  to the lower position. Then close the pump and wait for 5 seconds.
- Press down the steam button  to the lower position, and wait until the yellow indicator is illuminated. Make steam for 2 minutes, then turn the steam knob to the "O" position to stop making steam.
- Press the ON/OFF button to turn off the unit immediately, leave the descaler in the unit for at least 15 minutes.
- Empty the tank and refit with clean water. Restart the unit and repeat the above steps at least 3 times - with clean water.



HOW TO USE

- A lot of bother isn't it? Just use bottled water. It's easier!

CLEANING & MAINTENANCE

- Unplug from the mains and allow coffee maker cool down completely before cleaning.
- Clean housing of coffee maker with moisture-proof sponge often and clean water tank, drip tray and removable shelf regularly, then dry them.
- Do not clean with alcohol or solvent cleanser. Never immerse the housing in water for cleaning.
- Detach the metal funnel by turning it clockwise, get rid of coffee residue inside, then you can clean it with cleanser, be sure to rinse with clear water. Do not wash the metal funnel in a dishwasher.
- Clean all the attachments in the water and dry thoroughly.
- Note: Clean the appliance after every use in order to keep it working properly.

DO NOT ALLOW WATER TO SIT IN THE TANK FOR MORE THAN 2 DAYS. IT IS UNHYGIENIC. MICROBES COULD TAINT THE TASTE OF THE WATER

TROUBLE SHOOTING

Symptom	Cause	Remedy
Water leaks from the bottom of the machine	There is too much water in the drip tray or the tank is not seated properly	Clean out the drip tray and ensure tank is properly seated
Water leaks out of outer side of filter.	There is some coffee powder on filter edge	Clean it off
Tainted taste to the coffee	Improper cleaning, not descaling, allowing water to sit in the tank too long	Clean and descale as described above. Coffee powder could be off
Low or no steam from wand	Clogged up	Clean and descale properly
Poor milk frothing	Using skimmed milk	Full fat milk is best
Tainted taste	Poor water, unclean filter	Use good water. Clean filter after each use



SPARE PARTS

If you need any spare parts for this product please visit our web site and search "SK22010".

www.swan-brand.co.uk



NOTES





NOTES





WARRANTY

This product is guaranteed for 2 years from the date of original purchase. If any defect arises due to faulty materials or workmanship the faulty products must be returned to the place of purchase. Refunds or replacement is at the discretion of the store.

The following conditions apply:

- The product must be returned to the retailer with proof of purchase.
- The product must be installed and used in accordance with the instructions contained in this instruction guide.
- It must be used only for domestic purposes.
- It does not cover wear and tear, damage, misuse or consumable parts.
- Swan Products Ltd has limited liability for incidental or consequential loss or damage.
- This guarantee is valid in the UK and Eire Only.



BS PLUG

The wires in the mains lead are coloured in accordance with the following code:

BLUE	NEUTRAL
BROWN	LIVE
GREEN/YELLOW	EARTH

As the colours of the wire in the mains lead of this appliance may not correspond with the colour markings identifying the terminals on your plug, proceed as follows:

The wire which is coloured BLUE must be connected to the terminal which is marked with the letter N or coloured black. The wire which is coloured BROWN must be connected to the terminal which is marked with the letter L or coloured red. The wire which is coloured GREEN/YELLOW must be connected to the terminal which is marked with the letter E or [earth symbol] and is coloured GREEN or GREEN/YELLOW.

WARNING: THIS APPLIANCE MUST BE EARTHED



DISPOSAL OF UNIT



Appliances bearing the symbol shown here may not be disposed of in domestic rubbish. You are required to dispose of old electrical and electronic appliances like this separately. Please visit www.recycle-more.co.uk or www.recyclenow.co.uk for access to information about the recycling of electrical items. Please visit www.weeeiireland.ie for access to information about the recycling of electrical items purchased in Ireland. The WEEE directive, introduced in August 2006, states that all electrical items must be recycled, rather than taken to landfill. Please arrange to take this appliance to your local Civic Amenity site for recycling, once it has reached the end of its life.



www.swan-brand.co.uk



Scan this QR code
to hear about
our story



We love
what we do



we're proud
of our quality



Find us on Facebook

* on selected products

Copyright © Swan Products Ltd.
PO Box 3117, Stoke-on-Trent ST4 9GD

