



FACILITIES MAINTENANCE RANGE

Discover RS PRO, the value alternative at the right price.

Discover the complete RS PRO offer of solutions to make your everyday professional life easier, from batteries, tool kits, PPE, janitorial, cleaning and site safety equipment, to 3D printing supplies!

rspro.com



YOUR SMART CHOICE FOR FACILITIES MAINTENANCE

Discover RS PRO, the own brand, of RS, and our wide range of quality products across all industries. Our value alternative at the right price.

RS PRO offers customers with one brand that gives huge choice and solutions, proven quality and prices that can be trusted.

The wide range of facilities maintenance products from RS PRO covers all the needs of the professional engineer, technician and tradesman with quality products you can trust.

Since 1937, RS PRO has had a passion for industrial parts. More importantly, we believe that every part matters, because the quality of your applications will always be linked to the quality of every part going into them.

This is why we rigorously test every part against demanding industry standards to gain the RS PRO Seal of Approval.



To view our latest prices, charges and full terms see RS Conditions of Sale as set out online at sg.rs-online.com, my.rs-online.com, ph.rs-online.com and th.rs-online.com.

Published by: RS Group Plc

Registered offices:

Singapore: 133 Cecil Street #14 - 01 Keck Seng Tower Singapore 069535

Malaysia: Suite 12-9, The office Club, Level 12, Menara Mudajaya, No 12A, Jalan PJU 7/3 Mutiara Damansara, 47810 Petaling Jaya, Selangor

Philippines: 21/F Multinational Bancorporation Centre 6805 Ayala Avenue Makati City Philippines 1226

Thailand: 50 GMM Grammy Place, 19th Floor, Unit 1901-1904, Sukhumvit 21 Road (Asoke), Kongtoey Nua, Wattana, Bangkok Thailand 10110

DISCOVER THE WINNING COMBINATION FOR YOUR INDUSTRIAL SUPPLIES



Our products are tested for great performance and come with a 3-year warranty, where applicable.



Over 80,000 products available with a low return rate of less than 0.02%.



A combination of quality and choice, and sustainable product solutions, with competitive pricing against branded alternatives.

Always in stock, with reliable RS service

QUALITY TESTED

RS PRO products are audited against demanding international standards, inspected for durability and consistency and tested by leading engineers.

Only when products have been through this process they are awarded our seal of approval, demonstrating quality that can be trusted. Confidence in this process is reflected in our long product warranties - proof that our products will consistently deliver the quality you expect for a long time to come.



AUDITED

In compliance with industry standard



INSPECTED

By leading engineers



TESTED

For guaranteed quality and performance



MAINTENANCE SOLUTIONS FOR EVERY WORKING ENVIRONMENT

BUILDING & FACILITIES



Abrasives & Tools	Batteries	Cables & Wires
Chemical, Lubricants, Adhesives	Connectors	Environmental Monitoring
Fasteners	Facilities Cleaning & Maintenance	First Aid
Flooring & Mats	Fuses	Hand Tools
HVAC	Lockouts	Lighting
Power Supplies	Printing & Office	PPE, Workware & Footwear
Safety Signs & Labels	Storage & Material Handling	Tapes

OFFICE, PRODUCTION & DISTRIBUTION



Abrasives & Tools	Batteries	Cables & Wires
Cable Management	Chemical, Lubricants, Adhesives	Connectors
Environmental Monitoring	Facilities Cleaning & Maintenance	Fasteners
First Aid	Flooring & Mats	Fuses
Hand Tools	HVAC	Lockouts
Lighting	Multimeters	Pneumatics
Printing & Office	PPE, Workware & Footwear	Power Supplies
Safety Signs & Labels	Sensors & Thermocouples	Storage & Material Handling
Tapes	Temperature Monitoring	Traffic & Barriers

DESIGN & DEVELOPMENT LABORATORIES



Abrasives & Tools	Batteries	Cables & Wires
Chemical, Lubricants, Adhesives	Connectors	Environmental Monitoring
ESD Control	Fasteners	Facilities Cleaning & Maintenance
First Aid	HVAC	Janitorial & Cleaning
Lighting	Padlocks & Security	Printing & Office
Power Supplies	PPE, Workware & Footwear	Safety Signs & Labels
Storage & Material Handling	Tapes	Test & Measurement

WASHROOM



Batteries	Overalls	Facilities Cleaning & Maintenance
Padlocks & Security	Storage & Material Handling	Hand Care & Cleaning
Environmental Monitoring	Janitorial & Cleaning	First Aid
PPE, Workware & Footwear	Safety Signs & Labels	Lockouts
Tapes	Flooring & Mats	Lighting

PROFESSIONAL TOOL KITS 8

Engineering Tool Kits	9
Electrical Tool Kits	12
Mechanical Tool Kits	15

TOOL STORAGE 18

Tool Storage	19
--------------	----

INSULATED TOOLS 20

Insulated Pliers	21
Insulated Spanners	22
Insulated Screwdrivers	23

PLIERS & CUTTERS 24

Pliers	25
Utility Multigrip Pliers	26
Cutters & Shears	27

SPANNERS, SOCKETS & WRENCHES 28

Socket Sets - Impact	29
Socket Sets - 1/4 Inch	30
Socket Sets - 1/2 Inch	32
Socket Sets - 3/8 Inch	34
Socket Metric	35
Spanners & Wrenches	36
Cross Wrenches & Control Cabinet Keys	38
Nut Drivers & Splitters	39
Socket Wrenches	40

RIVET GUNS 41

Rivet Guns	41
------------	----

SCREWDRIVERS, HEX & TORX KEYS 42

Screwdrivers - Hex	43
Screwdrivers - Bits	45

HAMMERS & MARKING TOOLS 46

Hammers	46
Marking Tools	47

POWER TOOLS, SOLDERING & WELDING 48

Soldering & Welding	49
Drill Bits	50

SANDING, FILING & POLISHING TOOLS 52

Sanding Belts, Discs & Wheels	53
Sanding, Filing & Polishing Tools	54

THREADING TOOLS 55

Threading Tools	55
-----------------	----

CABLES, CONNECTORS & CRIMPING TOOLS 58

Terminal Blocks	59
AV Cables - HDMI	60
AV Cables	61
Computer Cables & Adaptors	62
Cable Management	64

TEST & MEASUREMENT TOOLS 66

Engineering Test & Measurement	67
Electrical Test & Measurement	68
Test Leads & Connectors	69
Environmental Test & Measurement	70
Temperature Test & Measurement	71
Test Leads & Connectors	72
Lab Equipment	73

SPECIALIST TOOLS 75

Specialist Tools	75
Tweezers	76

ESD CONTROL, CLEANROOM & PCB PROTOTYPING 77

PCB Prototyping	77
Anti Static Packaging	78
ESD Personal Grounding & Clothing	79
ESD Grounding Accessories, Brushes & Probes	81
ESD Matting	82
Clean Room Office Supplies	83
ESD Tools & Tapes	84
3D Printing Materials	86

ENCLOSURES & SERVER RACKS 87

Enclosures	87
Enclosures & Racking Components	89

HVAC, FANS & THERMAL MANAGEMENT 90

HVAC Air Filters	91
Air Conditioning & Heating Accessories	92

TORCHES 93

Torches	93
---------	----

ACCESS, STORAGE & MATERIAL HANDLING 94

Storage Boxes	95
Compartment Boxes	97
Storage & Shelving	98
Material Lifting & Loading Equipment	100

FACILITIES CLEANING & MAINTENANCE 102

Cleaning Equipment	103
Grease, Oil & Lubricant Dispensers	104

OFFICE & WAREHOUSE SUPPLIES 106

Office Furniture	107
Posting & Packaging	108
Site Essentials	111

ADHESIVES, SEALANTS & TAPES 112

Tapes	113
Safety & Hazard Tapes	115

PPE & SITE SAFETY 116

PPE & Workwear	116
Site Safety	118

SECURITY & IRONMONGERY 120

Locks & Bolts	121
Latches, Hinges & Handles	122

ENGINEERING MATERIALS & INDUSTRIAL HARDWARE 125

Anti Vibration & Levelling Components	125
Anti Vibration Mounts	126
Clamping Knobs & Levers	127
Plastic & Rubber Materials	128

PLUMBING & PIPELINE 130

Stainless Steel Pipe Fittings	131
Steel Ball Valves	132
Brass Ball Valves	133
Check Valves	136

PNEUMATIC CYLINDERS 138

Mini Cylinders & Accessories	139
ISO Cylinders & Accessories	140

PNEUMATIC VALVES 142

Solenoid Valves	143
Solenoid Pilot Valves	144

PNEUMATIC FITTINGS 146

Push-In Fittings - Polymer	147
Push-In Fittings - Stainless Steel	149
Threaded Adaptors - Stainless Steel	150
Adaptors - Nickel-Plated Brass	152
Function Fittings	154

TUBING & AIR TOOLS 155

Instrumentation Tubes	155
Air Tools	156

COMPRESSED AIR TREATMENT 158

Combination Units	159
-------------------	-----

PROFESSIONAL TOOL KITS

The RS PRO professional tool kit range is a collection of specialised tools and equipment designed to meet the needs of trades people in various industries, such as mechanics, electricians, plumbers, carpenters, and other skilled trades.

Engineering Tool Kits

RS PRO Engineering tool kits are carefully curated collections of high-quality tools and equipment specifically designed to cater to the needs of engineers. From mechanical assembly to equipment maintenance, prototyping to troubleshooting, these kits offer a comprehensive range of essential tools that are essential for a wide range of engineering tasks.

The kits include a range of essential tools such as wrenches, screwdrivers, pliers, and measuring instruments. Each tool is crafted with durability and ergonomic design in mind, ensuring long-lasting performance and comfortable use.



• Central locking system

• Low friction telescopic ball bearing slides, fully accessible drawers.

• Smart-Lock system on every drawer preventing accidental opening on the move.



• Recessed worktop

• Side holder for spray cans, etc. (only on RS-PLUS)

• Heavy duty oil proof rubber wheels (RS-PLUS Ø125 mm - 2 fixed and 2 swivelling, 1 with brake system)

Tool Set with 7 Drawer Roller Cabinet 240 Piece

- 7 drawer roller cabinet
- 240 Piece tool kit
- Recessed worktop with a high-quality mat
- Side compartments ideal for spray cans and paper rolls
- Low friction telescopic ball bearing slides ensuring smooth operation
- Fitted with an emergency brake
- Oil resistant wheels

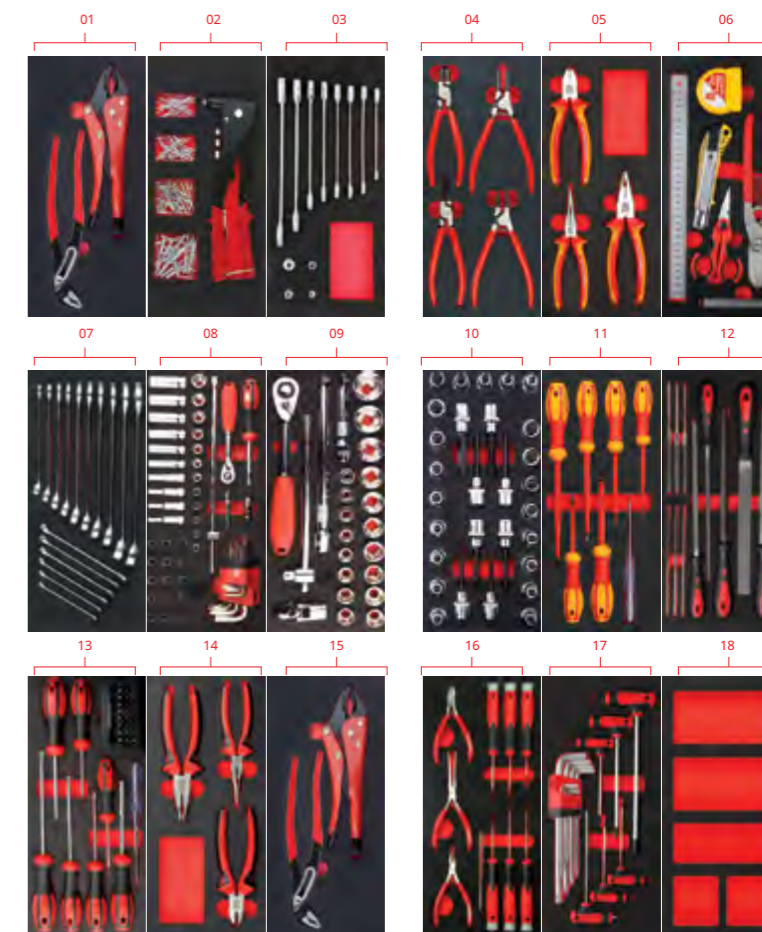

Tool Modules

Increased efficiency in workshops, missing tools can be identified at a glance thanks to the two colour design. 3 dimensional cut outs for each tool for a comfortable, snug fit.

Finger spaces for easy removal of tools

Chemically resistant high quality EVA material



Easy identification of missing tools

125-3046 240 Piece Tool Kit with 7 Drawer Roller Cabinet

Kit contains:

833-5966	01	2 Piece Climper and Stripper Set	833-5941	11	7 Piece Insulated Slotted/PH Screwdriver Set
833-5969	02	5 Piece Hand Riverter Set	833-5953	12	11 Piece Standard and Needle File Set
833-5925	03	12 Piece Ratcheting Combination Wrench Set	833-5947	13	39 Piece Slotted/PZ Screwdriver and Bit Set
833-5944	04	6 Piece Measuring and Cutting Tool Kit with Foam Inlay	833-5972	14	3 Piece Softgrip Pliers Set
833-5931	05	3 Piece VDE Insulated Pliers Set	833-5938	15	3 Piece Pliers and Adjustable Wrench Set
833-5929	06	4 Piece Circlip Pliers Set	833-5919	16	10 Piece Precision Plier and Screwdriver Set
833-5922	07	16 Piece Combination Wrench Set	833-5913	17	15 Piece L, T Metric Hex Key Set, 1.5 > 10, 2 > 6mm
833-5935	08	52 Piece 1/4" Drive Socket and Hex Key Set		18	5 Division EVA Module
833-5950	09	23 Piece 1/2" Drive Socket Set with Ratchet	833-5900	19	7 Drawers, 975 x 710 x 450, 66.4 kg
833-5957	10	29 Piece 1/2" TORX/Hex/XZN Socket Bits Set			

Engineers Tool Kit With Trolley
213 Piece

- Recessed worktop with a high-quality mat to ensure a convenient working area
- Holders for spray cans and paper rolls
- Smart-Lock system that prevents accidental opening
- Heavy duty oil resistant rubber wheels, with two fixed and two swivel wheels and emergency brake

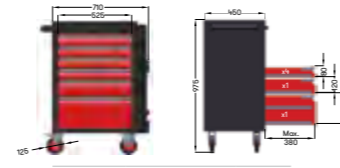

125-3047 213 Piece Engineers Tool Kit with Trolley

Kit contains:

- 833-5922** 01 16 Piece Combination Wrench Set
- 833-5935** 02 52 Piece 1/4" Drive Socket and Hex Key Set
- 833-5950** 03 23 Piece 1/2" Drive Socket Set with Ratchet
- 833-5957** 04 29 Piece 1/2" TORX/Hex/XZN Socket Bits Set
- 833-5941** 05 7 Piece Insulated Slotted/PH Screwdriver Set
- 833-5953** 06 11 Piece Standard and Needle File Set
- 833-5947** 07 39 Piece Slotted/PZ Screwdriver and Bit Set
- 833-5972** 08 3 Piece Softgrip Pliers Set
- 833-5938** 09 3 Piece Pliers and Adjustable Wrench Set
- 833-5919** 10 10 Piece Precision Plier and Screwdriver Set
- 833-5913** 11 15 Piece L, T Metric Hex Key Set, 1.5 > 10, 2 > 6mm
- 833-5944** 12 6 Piece Measuring and Cutting Tool Kit with Foam Inlay

6 Drawer Trolley 975 x 710 x 450



Roller Cabinet Tool Kit
160 Piece

- Premium sheet steel construction with electrostatic powder coating
- 5 drawers compatible with SBS inlays, each holds 3 SBS EVA tool modules
- Smooth telescopic ball bearing slides, central locking mechanism
- Recessed worktop with high-quality mat for convenient workspace

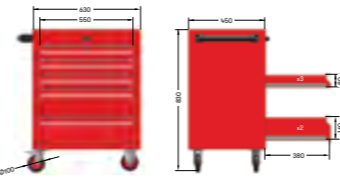

125-3048 160 Piece Roller Cabinet Tool Kit, 825 x 630 x 450

Kit contains:

- 833-5919** 01 10 Piece Precision Plier and Screwdriver Set
- 833-5913** 02 15 Piece L, T Metric Hex Key Set, 1.5 > 10, 2 > 6mm
- 833-5922** 03 16 Piece Combination Wrench Set
- 833-5950** 04 23 Piece 1/2" Drive Socket Set with Ratchet
- 833-5947** 05 39 Piece Slotted/PZ Screwdriver and Bit Set
- 833-5938** 06 3 Piece Pliers and Adjustable Wrench Set
- 833-5972** 07 3 Piece Softgrip Pliers Set
- 833-5935** 08 52 Piece 1/4" Drive Socket and Hex Key Set
- 09 5 Division EVA Module

5 Drawer Heavy Duty Roller Cabinet, 825 x 630 x 450

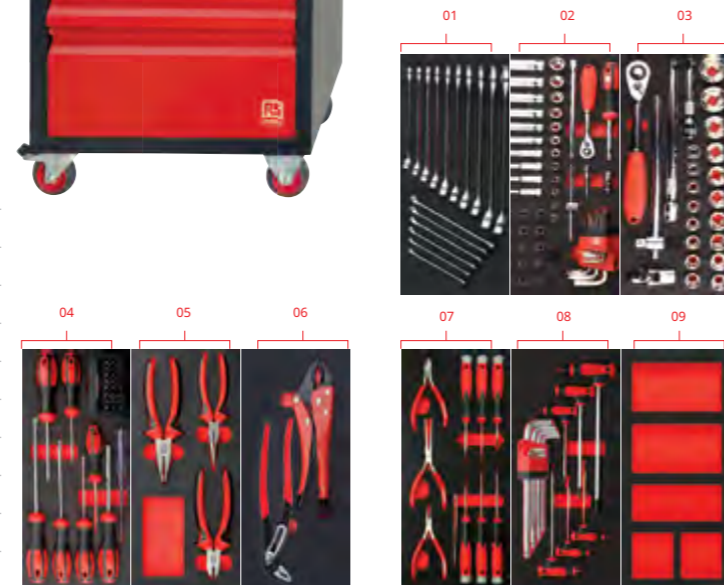

Engineers Tool Kit
25 Piece

- Impact resistant, waterproof IP67 case with customisable tool fixing system and a soft grip handle
- Comes complete with high-quality tools



136-3400 25 Piece Engineers Tool Kit with Case

Kit contains:

- | | |
|---|---|
| 01 Double Open End Wrench - 5x5.5 / 6x7 / 8x10 mm | 12 Compact Tape Measure - 3x16 mm |
| 02 6 Piece Needle File Set | 13 Electronics Short Needle Nose Pliers |
| 03 Gas Soldering Iron | 14 7 Piece Hexagon L Key Set - Metric |
| 04 Solder Sucker | 15 0.70 mm Wire Lead Solder, 100 g |
| 05 Trimming Knife | 16 Adjustable Wrench (Phosphate/PVC) - 150 mm |
| 06 Extra Fine Straight Tweezers | 17 Wire Stripping Pliers - 160 mm |
| 07 Jeweller's driver (4 blades) | 18 Diagonal Cutter - 140 mm |
| 08 3 Piece Trim Tool Kit | 19 Combination Pliers - 160 mm |
| 09 Single-Pole Voltage Tester | 20 Slotted Screwdriver - 4.0x100 / 6.5x100mm |
| 10 Electronics Slotted Screwdriver - 3x80 mm | 21 Pozidriv Screwdriver - PZ1x80 mm / PZ2x100mm |
| 11 Electronics Diagonal Cutter (Small Bevel) | |

VDE 1000 V Engineers Tool Kit

- Ergonomic multi-component handles
- Optimum balance of torque and control
- Ideal for fine and delicate work
- High quality



829-6549 23 Piece VDE 1000 V Engineers Tool Kit

Kit contains:

- 01 Phillips Screwdrivers PH1 x 100, PH2 x 100 mm, Slotted Screwdriver 1 x 5.5 x 125 mm, 0.8 x 4 x 100 mm
- 02 1/2" Sockets 10, 12, 13, 14, 17, 19, 22, 24 mm
- 03 Insulated VDE Open Ended Spanner Set 7, 8, 10, 12, 14 mm
- 04 150 mm Diagonal Pliers
- 05 200 mm Combination Pliers
- 06 1/2" Reversible Ratchet
- 07 1/2" T-Handle
- 08 Cable Knife

Electrical Tool Kits

Electrical tool kits are essential collections of tools and equipment specifically designed for electrical work. They provide users with a convenient and comprehensive solution for performing a wide range of electrical tasks safely and efficiently. These kits typically include a variety of hand tools such as screwdrivers, pliers, wire cutters, and strippers, as well as specialized instruments like multimeters, voltage testers, and cable trackers.

Whether you're tackling installations, repairs, or maintenance projects, RS PRO offers a diverse range of high-quality electrical tool kits that are designed to meet the needs of electricians and engineers. With ergonomic designs and durable components, the kits are built to withstand the demands of electrical work and ensure long-lasting performance.



**Electrician's Tool Kit
32 Piece**

- Ergonomic multi-component handles
- Optimum balance of torque and control
- High quality
- VDE approved for electrical safety
- Tool storage - comes in a sturdy tool case



136-3411 32 Piece Electricians Tool Kit with Case

Kit contains:

- | | |
|--|---|
| 01 Wallboard Saw - 160 mm | 14 Slotted Screwdriver (Flared Tip) - 10.0x200 mm |
| 02 Safety Goggles | 15 150 mm Screw Gripping Screwdriver |
| 03 Compact Tape Measure - 3x16 mm / 10 ft | 16 Stubby Slotted Screwdriver - 5.5x25 mm |
| 04 Claw Hammer - 16 oz. | 17 Stubby Pozidriv Screwdriver - PZ2x25 mm |
| 05 Flat Cold Chisel - 16x150/20x175mm | 18 Insulated Pozidriv Screwdriver (VDE) - PZ1x80/PZ2x100 mm |
| 06 Hacksaw (in-Handle Fixing System) | 19 Insulated Slotted Screwdriver (VDE) - 2.5x 75 / 4.0x100 mm |
| 07 Mini Hacksaw | 20 Long Nose Pliers - 160 mm |
| 08 Automatic Wire Stripper | 21 Diagonal Cutter - 160 mm |
| 09 Trimming Knife | 22 Combination Pliers - 200 mm |
| 10 Professional LED Flashlight | 23 RZR Series Cable Shears - 170 mm |
| 11 Marker Pen | 24 Multi-Purpose Cutter (Straight) |
| 12 Single-Pole Voltage Tester (Short) | 25 Adjustable Wrench (Phosphate/PVC) - 200 mm |
| 13 Electronics Slotted Screwdriver - 3x80 mm | 26 Water Pump Pliers (Box Joint/PVC) - 250 mm |
| | Water Pump Pliers (Box Joint/PVC) - 300 mm |

**Electricians Tool Kit
36 Piece**

- Ergonomic multi-component handles
- Optimum balance of torque and control
- High quality
- VDE approved screwdrivers and pliers for electrical safety
- Tool storage - comes in a sturdy tool case

VDE APPROVED



136-3417 36 Piece Electricians Tool Kit with Case

Kit contains:

- | |
|---|
| 01 Claw Hammer - 16 oz. |
| 02 Mini Hacksaw |
| 03 Compact Tape Measure - 3x16 mm / 10 ft |
| 04 Torpedo Level |
| 05 Ratchet Bit Driver Set |
| 06 Rethreading Tool - M3.5 |
| 07 Single-Pole Voltage Tester (Short) |
| 08 Non-Contact |
| 09 Insulated Pozidriv Screwdriver (VDE) - PZ1x80 / PZ2x100 / Flat-Pozi 2x100mm |
| 10 Insulated C-PLUS Phillips Screwdriver (VDE) - PH1x80/PH2x100 mm |
| 11 Insulated C-PLUS Slotted Screwdriver (VDE) - 3.0x100/4.0x100/ 5.5x125/6.5x150 mm |
| 12 Automatic Wire Stripper |
| 13 Cable Stripper |
| 14 Electrician Knife (1000V) |
| 15 Insulated Combination Pliers (VDE) - 180 mm |
| 16 Insulated Diagonal Cutter (VDE) - 160 mm |
| 17 Insulated Long Nose Pliers (VDE) - 200 mm |
| 18 RZR Series Insulated Cable Shears (VDE) - 170 mm |
| 19 Insulated Water Pump Pliers (VDE) - 250 mm |
| 20 Tool Case, 530 x 180 x 400mm |

Electrician's Tool Kit

- Ergonomic multi-component handles
- Optimum balance of torque and control
- Ideal for fine and delicate work
- High-quality multi-tools and accessories
- Range of labels

**136-3402** 29 Piece Electricians Tool Kit with Case**Kit contains:**

- | | |
|---|---|
| 01 Electrician Knife (1000V) | 13 Insulated Pozidriv Screwdriver (VDE) - PZ0x60/PZ1x80/PZ2x100/PZ3x150mm |
| 02 RZR Series Insulated Cable Shears (VDE) - 170 mm | 14 Insulated Slotted Screwdrivers (VDE) - 2.5x75/4.0x100/5.5x125/6.5x150/8.0x175mm |
| 03 Insulated Wire Stripping Pliers (VDE) - 160 mm | 15 "Danger" Label |
| 04 Insulated Diagonal Cutter (VDE) - 160 mm | 16 "H.V. Test Area" Label |
| 05 Insulated Combination Pliers (VDE) - 180 mm | 17 "Electric Shock" Label |
| 06 Insulated Long Nose Pliers (VDE) - 200 mm | 18 "Live Wires" Label |
| 07 Insulated Open End Wrench (1000V) - 5.5/6/7/8/10/12/13/17/19 mm | 19 "High Voltage Label |
| 08 Safety Goggles | 20 "Disconnect" Label |
| 09 Black/Yellow insulation tape | 21 "415 V a.c." Label |
| 10 "Unsafe" Label | 22 "240 V a.c." Label |
| 11 Junior Hacksaw (1000V) | 23 "115 V a.c." Label |
| 12 Insulated Water Pump Pliers (VDE) - 250 mm | |

125-3049 Tool Case, 530 x 180 x 400mm**Electricians Tool Kit**

- An extensive VDE approved tool kit designed for professionals who work on or around electrically live circuits.
- Ergonomic multi-component handles
- Constructed from Chrome Vanadium Steel
- Versatile and durable carry case complete with cut-out slots for each individual component.

**VDE APPROVED****734-8885** 88 Piece Electricians Tool Kit with Case**Kit contains:**

- | | |
|-------------------------------------|--|
| 1/2 Inch Sockets (14 - 32mm) | 6in Insulated Slip joint pliers |
| 1/2 Inch Extension (125 & 250mm) | 6in Insulated Nipper pliers |
| 1/2 Inch Plug Wrench (16 & 21mm) | 6in Insulated Wire strippers, 7in Insulated Wire cutters |
| 1/4in Sockets (4 - 13mm) | Insulated Water pump pliers |
| 1/4in Extension (55 & 100mm) | Electricians Shears |
| 1/4in Connector | 250V Test pencil |
| 1/2 Inch & 1/4in Reversible Ratchet | 300g Hammer |
| 1/2 Inch & 1/4in Universal Joint | 5m Tape measure |
| 1/2 Inch & 1/4in Sliding T bar | Driver bits (x20) |
| Metric Wrench (8 - 17mm) | Insulated Screwdrivers (x5) |
| | Hex Keys (x9) |

Mechanical Tool Kits

Designed to cater to the needs of professionals tackling mechanical tasks, the RS PRO Mechanical Tool Kits offer curated assortments of essential tools.

Featuring a diverse range of instruments including wrenches, sockets, screwdrivers, pliers, hammers, and measuring tools, these kits provide comprehensive support for tasks ranging from intricate assembly to routine maintenance and complex repairs.

Whether you're an automotive mechanic fine-tuning engine components, an industrial engineer overseeing machinery operations, or a maintenance technician ensuring system integrity, these kits equip you with the versatility and reliability needed to excel in your mechanical endeavors.

**Electro-Mechanical Basic Tool Kit**

- Supplied in a hard-wearing case made from highly resistant injected polypropylene
- Case has combination lock, document holder, a ceramic soldering iron holder and a single and double sided tool holder tray
- Three adjustable separators

**178-043** 48 Piece Electro-Mechanical Basic Tool Kit with Case**Kit contains:**

- 1 Nylon Cleaning Brush
- 1 Cylindrical Punch
- 1 Adjustable Spanner
- 10 Angled Male Spanners
- 4 Flat Spanners
- 1 Electrician's Knife
- 1 Soldering Iron
- 1 Rivet Hammer
- 1 Insulated Mirror
- 1 Saw Frame with Spare Blades
- 1 Pair of Electrician's Scissors
- 1 Pair of Stripping Pliers
- 1 Pair of Straight Tweezers
- 1 Reversible Retaining Ring Pliers
- 4 Pairs of Cutting Pliers
- 1 Pair of Multigrip Pliers
- 1 Pair of Flat Pliers
- 1 Pair of Round Electronic Pliers
- 1 Steel Punch
- 500 g 10/10 mm Lead-Free Solder Wire
- 1 Roll of Adhesive Tape
- 1 Jeweller's Screwdriver
- 5 Expert Screwdrivers
- 4 PH00-PH0-PH1-PH2 Screwdrivers
- 2 Desoldering Braids

**Mechanics Tool Kit
94 Piece**

- Contains a useful selection of sockets, spanners, universal joints, hex bit couplers, hex bits, precision screwdrivers and extension bars in various sizes
- And all are high quality RS PRO tools

**734-8889** 94 Piece Mechanics Tool Kit**Kit contains:**

- 1/2" Sockets 13, 14, 15, 16, 17, 18, 19, 20, 21, 22, 23, 24, 27, 30, 32 mm
- 1/4" Sockets 4, 4.5, 5, 5.5, 6, 7, 8, 9, 10, 11, 12, 13 mm
- Ratchet Handle, Universal Joint and Sliding T-bar
- 1/2" Quick Release Ratchet
- 1/4" Quick Release Ratchet
- 1/2" Universal Joint (Rivet Type)
- 1/4" Universal Joint (Rivet Type)
- 3/8" T-bar Adapter
- 1/4" 110 mm Sliding T-bar
- Combination Spanners 8, 10, 11, 12, 13, 14, 17, 19, 22 mm
- Precision Screwdrivers Slotted: 1.5, 2, 3 mm Phillips: No.0-0, No.0, No. 1 Torx: T6, T8, T10
- Screwdriver Bits 25 (L) x 6.35 mm Hexagon Bits; Slotted: 4, 5, 6 mm; Phillips: No.1, No.2; Pozi: No.1, No.2; Hex Bits: 3, 4, 5 mm; Torx: T10, T15, T20, T25, T27, T30; 30 (L) x 10 mm
- Hexagon Bits Slotted: 7, 8, 10 mm; Phillips: No.3, No.4; Pozi: No.3, No.4; Hex Bits: 6, 7, 8, 10 mm; Torx: T30, T40, T45, T47, T50
- Spark Plug Sockets 16 and 21 mm
- 1/2" 125 and 250 mm Extension Bar
- 1/4" 55, 100 and 250 mm Extension Bar
- 1/4" 150 mm Spinner
- 1/4" Screwdriver Bit Coupler
- 1/2" Screwdriver Bit Coupler
- Blow Moulded Case

78 Piece Mechanics Socket & Tool Set

- High quality set supplied fitted in a blow moulded carry and storage case
- Chrome Vanadium steel construction
- Socket stamp with sizes for quick identification
- Visit our website for more details on contents



829-6568 78 Piece Mechanics Socket & Tool Set

Kit contains:

- Sockets
 1/2" Sockets: 10, 11, 12, 13, 14, 15, 17, 19, 22, 24, 27, 30, 32 mm
 1/4" Sockets: 4, 5, 6, 7, 8, 9, 10, 11, 13 mm
 1/4" Deep Sockets: 8, 10, 12, 13 mm

- Spark Plug Socket
 16 and 21 mm

- Ratchet and Handles
 1/2" Quick Release Ratchet
 1/2" Sliding T-Handle
 1/4" Quick Release Socket Ratchet
 1/4" Sliding T-Handle
 1/4" Spinner Handle

- Socket Attachments
 1/2" Extensions - 125 and 250 mm
 1/4" Extension Bar - 75 mm
 1/4" Flexible Extension
 1/2" Universal Joint
 1/4" Universal Joint
 1/4" Coupler

- Pliers
 180 mm Combination Pliers
 250mm Water Pump Pliers

- 18 Piece Hex Bit Set
 1/4" Hex Bits: 3, 4, 5, 6 mm
 1/4" Slotted Bits: 3, 4, 5, 6 mm
 1/4" Phillips Bits: PH1, PH2, PH3
 1/4" Pozidriv Bits: PZ1, PZ2, PZ3
 1/4" Torx Bits: T10, T15, T20, T25

- Combination Spanners
 8, 10, 12, 13, 14, 15, 17, 19 mm

- Screwdrivers
 Slotted: 6 x 100, 4 x 100 mm
 Phillips: PH1 x 75, PH2 x 100, PH3 x 150 mm

- Additional Extras
 Hex Key Set 300 g Hammer

73 Piece Mechanical Tool Kit with Case

- 3/8in socket components
- Chrome Vanadium steel construction
- Sandblasted finish
- Sockets stamp with sizes for quick identification
- Full Allen key set



829-6561 73 Piece Mechanical Tool Kit with Case

Kit contains:

- Screwdrivers
 Slotted: 5.5 x 100, 6.5 x 150, 6.5 x 38 mm
 Phillips: PH1 x 100, PH2 x 150, PH2 x 38 mm

- Ratchets and Sockets
 3/8" Quick Release Ratchet
 Spark Plug Socket: 16 mm
 3/8 in Extension: 75 mm
 3/8 in Universal joint
 3/8 in Sockets
 6, 7, 8, 9, 10, 11, 12, 13, 14, 15, 16, 17, 18, 19 mm

- Spanners
 Combination: 8, 10, 11, 12, 13, 14, 15, 16, 17, 18, 19 mm
 200 mm Adjustable Wrench

- Pliers
 160 mm Long Nose
 180 mm Combination
 250 mm Water Pump

- Bits and Drivers
 Bit Driver

- 21 Bit Piece Set
 x4 Phillips Bit: PH0, PH1, PH2, PH3
 x4 Pozidriv Bits: PZ0, PZ1, PZ2, PZ3
 x5 Torx Bits: T10, T15, T20, T25, T30
 x5 Slotted Bits: 3, 4, 5, 6, 7 mm
 x3 Hex Bits: 3, 4, 5 mm

- Additional Extras
 300g Hammer
 Utility Knife
 Magnetic Pick Up
 5 M Tape Measure
 Hex Key Set: 1.5, 2, 2.5, 3, 4, 5, 6, 8, 10 mm

Mechanics Tool Kit 82 Piece

- Ergonomic multi-component handles
- Optimum balance of torque and control
- High quality
- Tool storage - comes in a sturdy toolbox - foldout construction for easy access & large storage capacity



136-3412 82 Piece Mechanics Tool Kit

Kit contains:

- | | | | |
|----|---|----|--|
| 1 | Flat Chisel 21x150mm/Centre Punch - 4x120mm/ Parallel | 14 | 1/2 Inch Dr. Extension Bar-125mm |
| 2 | Pin Punch 3,4,5,6 x150mm | 15 | 1/2 Inch Dr. Extension Bar-250mm |
| 3 | Soft Face Hammers | 16 | 1/2 Inch Dr. Universal Joint |
| 4 | Ball Pein Hammer - 16 oz. | 17 | 18 Piece Hexagon L Key Set - Metric / Imperial |
| 5 | Stainless Steel Rules - 30mm | 18 | Long Nose Pliers - 160 mm |
| 6 | Water Pump Pliers (Box Joint/PVC) - 250 mm | 19 | Diagonal Cutter - 160 mm |
| 7 | Compact Tape Measure - 3x16 mm / 10 ft | 20 | Combination Pliers - 180 mm |
| 8 | Feeler Gauge(Metric- 0.05-1.00mm) | 21 | Pozidriv Screwdriver - PZ1x80 mm / PZ2x100 mm |
| 9 | Trimming Knife | 22 | Slotted Screwdriver - 4.0x100 / 5.5x125 / 6.5x150 / 8.0x150mm |
| 10 | Double Open End Wrench - 5x5.5/6x7/8x10 mm | 23 | Single-Pole Voltage Tester (Short) |
| 11 | 12 Piece Combination Wrench Set | 24 | Stubby Slotted Screwdriver - 5.5x25 mm / Stubby Pozidriv Screwdriver - PZ2x25 mm |
| 12 | 1/2 Inch Dr. 6-Point Sockets - 18 pieces | 25 | Padlock |
| 13 | 1/2 Inch Dr. Quick Release Reversible Ratchet | | |
| | 1/2 Inch Dr. Sliding T-Handles | | |



Mechanical Tool Kit 42 Piece

- Ergonomic multi-component handles Optimum balance of torque and control
- High quality
- Sturdy tool box



136-3415 42 Piece Mechanical Tool Kit

Kit contains:

- | | | | |
|---|--|----|--|
| 1 | Ball Pein Hammer - 16 oz. | 8 | Combination Pliers - 180 mm |
| 2 | 12 Piece Combination Wrench Set | 9 | Water Pump Pliers (Box Joint/PVC) - 250 mm |
| 3 | Trimming Knife | 10 | Single-Pole Voltage Tester (Short) |
| 4 | Compact Tape Measure - 3x16 mm / 10 ft | 11 | Pozidriv Screwdriver - PZ1x80 / PZ2x100 mm |
| 5 | Flat Chisel 21x150mm/Centre Punch - 4x120 mm/Parallele | 12 | Slotted Screwdriver (Cabinet Tip) - 3.0x075 / 4.0x100 / 5.5x125 / 6.5x150 mm |
| 6 | Pin Punch 3,4,5,6 x 150mm | 13 | 9 Piece Hexagon L Key Set - Metric |
| 7 | Long Nose Pliers - 160 mm | 14 | Padlock |
| | Diagonal Cutter - 160 mm | | |



TOOL STORAGE

A range of tool storage solutions, including toolboxes, tool cabinets, and tool chests, offering organized and secure storage for tools and accessories, ensuring easy access and efficient management.

Wall Mount Tool Cabinet With Drawers

- Lockable doors
- Hook tool storage
- Fully extendable drawer
- Sturdy steel construction
- Two piano hinged lockable doors
- Assorted hooks
- Made from heavy gauge steel



851-7610 2 Drawers, 890mm x 225mm x 750mm

851-7616 1 Drawer, 900mm x 195mm x 615mm

Tool Chests

- Electrostatic matt powder coated, scratch proof.
- 80 mm deep top locker.
- Integrated carrying handles.



768-1671 6 Drawers, 350mm x 530mm x 340mm, 18kg

768-1678 3 Drawers, 365mm x 620mm x 440mm, 20kg

7 Drawer Cabinet

- Sturdy, premium sheet steel construction
- Electrostatic powder coating, scratch-resistant
- 7 fully extendible drawers with tool module compatibility
- Smart-Lock™ system prevents accidental opening
- Smooth telescopic ball bearing slides
- Central locking, holders for spray cans and paper rolls
- Recessed worktop with quality mat



833-5900 7 Drawers, 975 x 710 x 450, 66.4 kg

833-5903 7 Drawers, Jumbo Size, 975 x 890 x 450, 72.5 kg

4 Drawer Tool Chest

- Sturdy and dependable construction, premium quality sheet steel.
- Elegant and durable electrostatic matt powder coated, scratch proof.
- 4 drawers - compatible with tool modules inlays.
- Each drawer can accommodate 4 EVA tool modules.
- 80 mm deep top locker with integrated locking mechanism
- Low friction telescopic ball bearing slides ensuring silk smooth operation.
- Integrated carrying handles



833-5907 4 Drawers, Jumbo Size, 476mm x 440mm x 794mm, 31.2kg

8 Drawer Steel Tool Chest

- 80mm deep top locker with an integrated locking mechanism
- Low friction telescopic ball bearing slides
- 8 separate drawers with varying sizes
- Carrying handles



773-2735 427mm x 660mm x 307mm

Tool Case

- Waterproof (IP67)
- Dustproof
- Impact/shock resistant
- Stackable
- Soft-grip carry handle
- Lockable with padlock (not included)



125-3049 530 x 180 x 400mm, 5kg

IP67
RATED

11 Drawer Cabinet

- Sturdy, premium sheet steel construction
- Electrostatic powder coating, scratch-resistant
- 11 fully extendible drawers, 5 compatible with tool modules
- Telescopic slides for smooth operation, bottom drawer with double slides
- Foamed rubber mats in drawer bases, central locking
- Smart-Lock™ system prevents accidental opening
- Recessed worktop with quality mat



833-5916 11 Drawers, 985 x 1085 x 450, 90 kg

6 Drawer WRS PLUS

- Sturdy construction, premium sheet steel
- Electrostatic powder coating, scratch-resistant
- 6 drawers compatible with SBS inlays
- Telescopic slides, bottom drawer with double slides
- Each drawer holds 3 SBS EVA tool modules
- Smart-Lock™ system prevents accidental opening
- Central locking, adjustable middle tray
- Directly accessible tray for bulky items
- Recessed worktop with quality mat, compatible with A01-PL tool panel



875-5789 6 Drawers, 980 x 1090 x 450, 66.3 kg

Backpack With Shoulder Strap

- Reflective piping enhances visibility for safety.
- Comfortably padded shoulder straps ensure ease of carrying.
- Double zipped bottom section provides secure laptop storage, with additional pockets and holders for organisation.



788-7211 340mm x 220mm x 410mm

Tool Bag With Shoulder Strap

- Constructed with tear-resistant padded polyester, with a durable welded waterproof plastic base. This ensures that your cargo is adequately protected against the elements and casual impacts.



788-7205 310mm x 200mm x 210mm

Instrument Bag

- Padded bags designed for the safe transportation of sensitive electronic equipment, tools and components.
- Constructed from tough, waterproof Polyester.
- Front zipper pocket, black shoulder strap, with adjustable function & buckle
- Removable base board



707-7335 445mm x 170mm x 330mm

INSULATED TOOLS

RS PRO offers a wide range of insulated tools, including insulated screwdrivers, insulated pliers, insulated wrenches, and insulated electrical testers, ensuring safety and protection against electrical shocks for professionals working with live circuits.

VDE Approved Tools

The best electrician's tools are fully insulated against electrical shocks: an obvious safety hazard. Look for those with accreditation from the Verband der Elektrotechnik, Elektronik und Informationstechnik (VDE) – the German Association of Electrical Engineering, Electronics and Information Technology, which provides an internationally recognised standard for electrical safety.

VDE approval ensures that tools like screwdrivers are safe to use when working with electricity. A VDE approved tool means that it has passed a series of rigorous tests ensuring the quality, safety and construction.



Insulated Screwdriver and Pliers Set

- A 5 piece electricians' hand tool kit which includes the most essential tools to perform a variety of repair and maintenance tasks within an electrical environment
- Made from Chrome Vanadium Steel for increased durability and strength, allowing for longer-lasting tool life
- DuoTech soft-grip plier handles for optimum comfort and grip, even when working for long periods of time
- Each screwdriver has been designed with the ergonomic C-PLUS soft-grip handles, allowing for even transfer of force and increased comfort when applying large amounts of force for stubborn fasteners



125-3096 5 Piece Set - 1 x Insulated Combination Pliers (G10 Series), 1 x Insulated Diagonal Cutter (G12 Series), 2 x C-PLUS Insulated Slotted Screwdrivers (G01 Series), 1 x C-PLUS Insulated Pozidriv Screwdrivers (G03 Series)

VDE APPROVED

Insulated Electrician's Knife

- 1000V approved cable knife, ideal for use on or around energised systems
- Sickle shaped strong and durable stainless-steel blade for long lasting blade life and can easily and efficiently cut the cable sheath without the risk of damaging the cable
- Blade guard on handle to avoid slippage injuries



829-6518 44mm Blade

VDE APPROVED

RS PRO

INSULATED PLIERS

Plier Sets

- Special tool steel Polished finish (electofilmed)
- DuoTech soft grip handles
- G10 - ISO 5745
- G12 - ISO 5749

VDE APPROVED



125-3094 2 Piece Set - Insulated Combination Pliers (G10 Series) & Insulated Diagonal Cutter (G12 Series)

Insulated Plier Set with Foam Module

- 3 Piece VDE Plier Quality Set is for working on 1000V AC or 1500V DC
- DuoTech Soft grip handles allow for easy and smooth action
- Smooth Operating Action reduces the fatigue of the user
- Supplied with Foam Module ensures the tools are kept tidy

VDE APPROVED



833-5931 3 Piece Set, 180mm Combination Pliers (G10), 160mm Diagonal Cutters (G12), 160mm Long Nose Pliers (G15)

Plier Sets

- Special tool steel
- Chrome finish
- DuoTech soft grip handles

VDE APPROVED



125-3095 3 Piece Set - Diagonal cutter, long nose plier & combination plier

Insulated Water Pump Pliers

- Ideal for live working up to 1000Vac or 1500Vdc
- 9 position adjustment
- Chrome Vanadium steel
- Phosphate finish
- Soft-grip handles

VDE APPROVED



125-3076 Multigrip Slip Joint, 250mm

Insulated Combination Pliers

- Special tool steel and chrome finish
- DuoTech soft grip handles
- VDE Approved, ISO 5745

VDE APPROVED



125-3065 G10 Series, Combination, 160mm

125-3066 G10 Series, Combination, 180mm

125-3067 G10 Series, Combination, 200mm

Insulated Long Nose Pliers

- Chrome finish
- DuoTech soft grip handles
- ISO 5745
- G15 Series

VDE APPROVED



125-3072 G15 Series, Long nose, 160mm

125-3073 G15 Series, Long nose, 200mm

Diagonal Cutters

- Special tool steel; Chrome finish
- DuoTech soft grip handles
- ISO 5749, G12 Series

VDE APPROVED



125-3070 G12 Series, 180 mm

125-3068 G12 Series, 140 mm

125-3069 G12 Series, 160 mm

Angled Long Nose Insulated Pliers

- Special tool steel
- Chrome finish
- DuoTech soft grip handles
- VDE Approved, ISO 5745

VDE APPROVED



125-3074 G16 Series, Bent nose, 200mm

Insulated Pliers

- 45° angled blades
- Ergonomic handles
- Ideal for precision work with soft wire

VDE APPROVED



847-3800 Long nose

Insulated Non-Impact Sockets

- Bi-Hex (12 point) Socket Heads
- Each tool is injection moulded
- Nylon 11 insulation
- 1/2 Inch Square drive
- 8mm to 32mm sizes available
- IEC60900, Category 'C', 1000v

IEC 60900:2004



911-1402	8mm
911-1409	10mm
911-1411	12mm
911-1415	13mm
911-1424	14mm
911-1421	16mm
911-1430	17mm
911-1433	18mm
911-1437	19mm
911-1446	20mm
911-1443	22mm
911-1455	24mm
911-1459	25mm
911-1461	27mm

Insulated Ratcheting Ring Spanners

- The 72-tooth ratchet ring and gear produce a 5° rotation allowing it to function in tight spaces.
- Each tool is injection moulded
- Nylon 11 insulation
- IEC 60900:2004 specification

IEC 60900:2004



911-1308	10mm
911-1310	13mm
911-1326	17mm

Insulated Reversible Ratchet Spanners

- Each tool is injection moulded
- Reversible for added flexibility
- Nylon 11 insulation
- IEC 60900:2004 specification

IEC 60900:2004



911-1487	13x17mm
911-1496	17x19mm

Insulated Ring Spanners

- Single Ended with 60° Offset Head
- Each tool is injection moulded with Nylon 11 insulation
- IEC 60900:2004 specification
- Heavy-duty spanners for use in any application

IEC 60900:2004



911-1288	10mm
911-1281	13mm
911-1285	17mm
911-1294	19mm

Insulated Open Ended Spanners

- Each tool is injection moulded
- Nylon 11 insulation
- IEC 60900:2004 specification
- Warning thumb stop

IEC 60900:2004



911-1187	10mm
911-1193	13mm
911-1203	17mm

Insulated Torque Wrenches

- Each tool is injection moulded with Nylon 11 insulation
- IEC 60900:2004 specification
- Easy to read Window scale
- Reversible action

IEC 60900:2004



911-1531	1/2"
911-1522	3/8"

Hexagon Nut Driver Set

- Made from chrome vanadium molybdenum steel blade material
- Hexagon tip type
- VDE/1000 V approved

VDE APPROVED



182-9772	Set of 5 - Tip size of 6 mm, 7 mm, 8 mm, 10 mm, 13 mm
----------	---

Insulated Nut Spinners

- 150mm stud clearance
- Each tool is injection moulded
- Nylon 11 insulation
- IEC 60900:2004 specification
- Available in various metric and BA sizes

IEC 60900:2004



911-1503	0BA
911-1506	1BA
911-1500	2BA
911-1519	3BA
911-1512	4BA
911-1525	8mm
911-1528	10mm

Insulated Screwdrivers

- For live working up to 1000 V ac or 1500 V dc
- Chrome Vanadium Molybdenum steel blade (phosphate finish)
- C-PLUS soft-grip handle
- Individually tested as per DIN EN 60900: 2004 norm

VDE APPROVED



125-3078	2.5 x 75mm
125-3080	3.5 x 100mm
125-3079	3 x 100mm
125-3081	4 x 100mm
125-3082	5.5 x 125mm
125-3083	6.5 x 150mm
125-3088	MOD1 x 80mm
125-3089	MOD2 x 80mm
125-3084	Ph1 x 80mm
125-3085	Ph2 x 100mm
125-3086	Pz1 x 80mm
125-3087	Pz2 x 100mm

Screwdriver Set with Voltage Tester

- Slotted and Pozidrive screwdrivers
- VDE approved tools for working in rigorous health and safety standards
- Voltage tester included
- Ergonomic soft grip handles

VDE APPROVED



875-5812	4 x Slotted Screwdrivers (3 mm, 4 mm, 5.5 mm, 6.5 mm), 2 x Philips Screwdriver (PH1, PH2), 1 x Voltage Tester
----------	---

Insulated Screwdriver Set

- 10-Piece 1000V insulated screwdriver set manufactured with durable chrome-molybdenum vanadium steel and easy grip handles

VDE APPROVED



253-015	Slotted (2.5; 3; 4; 5.5; 6.5mm), Phillips (PH0; PH1 PH2), Pozidriv (PZ0; PZ1)
---------	---

4 Piece Slotted Insulated Screwdriver Set

- 1000Vac and 1500Vdc voltage isolation
- DuoTech ergonomic handle
- Tested according to DIN EN 60900: 2004
- For full set contents visit our website

VDE APPROVED



125-3092	3 x Slotted, 1 x Phillips
125-3093	3 x Slotted, 1 x Pozi

Screwdriver Set with Voltage Tester

- Slotted and Pozidrive screwdrivers
- VDE approved tools for working in rigorous health and safety standards
- Voltage tester included
- Ergonomic soft grip handles

VDE APPROVED



875-5821	4 x Slotted Screwdrivers (3 mm, 4 mm, 5.5 mm, 6.5 mm), 2 x Pozi Screwdrivers (PZ1, PZ2), 1 x Voltage Tester
----------	---

PLIERS & CUTTERS

RS PRO offers a wide variety of pliers and cutters, including combination pliers, long-nose pliers, wire cutters, and cable cutters, providing reliable gripping and cutting solutions for various applications.

Cr-V Snipe Nose Pliers

- Made from chrome vanadium steel
- Ergonomic handles, make an excellent choice for electricians, designers etc.



847-3765 120 mm Overall, Straight Tip

General Purpose Electronic Pliers

- Strong pressed steel frame
- Riveted lap joint
- Precision ground 3mm jaw
- Ribbed soft plastic grips and lightweight return spring
- Integral stop



606-535 Flat
606-529 Needle nose
606-541 Serrated jaw

Din Standard Pliers

- Soft grip dual component handles for ease of use
- Box joint construction
- Manufactured from high-grade steel
- Ergonomically designed sleeves for comfort and effortless use.
- Made in Germany



161-142 Round nose

High Carbon Steel Long Nose Pliers

- Ideal for electricians or tradesmen that need to grip and cut wires, bend loops or grip small objects



847-3803 Bent nose 200mm
847-3793 Long nose

Long Nose Pliers

- The Unigrip ergonomic handles, make these pliers suitable for cutting soft and hard wire



875-5809 160mm

Stainless Steel Pliers

- 25mm long stainless steel jaws
- Fitted with moulded plastic grip with lightweight return spring
- Overall length 130mm



536-335 Half round
536-357 Bent nose
536-341 Serrated flat

3 Piece Plier Set, 250 Mm Overall

- 3 Piece Plier Quality Set with Polished Finish
- Ergonomic Soft grip handles allow for easy and smooth action
- Smooth Operating Action reduces the fatigue of the user
- Serrated jaws for an excellent prolonged grip
- Supplied with Foam Module ensuring the tools are kept tidy



833-5972 3 Pieces - 180 mm Combination Pliers, 160 mm Diagonal Side Cutters & 160 mm Long Nose Pliers

Combination Pliers

- Optimum cutting edge geometry
- Precision milled
- Heat treatment to exacting standards
- Redesigned DuoTech grips



875-5767 140mm
487-230 150mm
875-5761 160mm
875-5770 180mm
875-5773 200mm
875-5802 200mm

Engineers Pliers

- Induction hardened with a natural finish to ensure a long, reliable working life
- Ergonomically designed bow handles with PVC grip provide maximum leverage and comfort



541-7093 Radio 140mm
541-7071 Snipe nose 120mm
541-7043 Snipe nose 160mm

Electronic Pliers

- Strong and Hardwearing body
- Specially designed ergonomic handles



847-3780 Slim Side cutters, 4.5 inch, Cutting capacity soft wire: <0.8mm
847-3784 Side cutters, 4.5 inch, Cutting capacity soft wire: <1.3mm
847-3816 End nipper

Diagonal Cutters

- Duo Tech soft grip handles
- Polished finish (Electrofilmed)
- DIN/ISO 5749, TS 11071



875-5792 140mm
875-5795 160mm
875-5799 180mm
875-5806 Power 180mm

Electronic Pliers

- Strong and Hardwearing body
- Specially designed ergonomic handles



847-3756 Radio 140mm
847-3724 Radio 200mm
847-3730 Round nose 130mm
847-3752 Snipe nose 120mm
847-3737 Snipe nose 130mm

Plier and Wrench Tool Module

- Box jointed waterpump pliers with PVC sleeves for a firm grip
- Locking grip plier with fine adjustment. Ideal for automotive or welding applications
- Adjustable wrench with scale marked onto jaws for easy adjustment and setting. Phosphated finish for protection and long tool life
- Bright red foam helps identify missing parts quickly
- Foam tool modules are designed for regular easy removal from drawers



833-5938 3 Piece Set - 250mm Waterpump Pliers, 240mm Grip Plier, 250mm Adjustable Wrench

Utility Pliers

- Right angle teeth grip in all directions
- Undercut tongue and groove with 3 to 12 adjustment positions
- Reinforced edge minimizes stress breakage
- Made of high carbon C1080 steel for superior performance
- Specially coated for ultimate rust prevention



216-6039 400mm
325-6228 500mm

Box Joint Pliers

- Hardened and tempered throughout for strength and durability
- Narrow/slim heads are ideal for use in confined spaces
- Serrated jaws give positive grip on round, square, triangular, flat and irregular surfaces
- PVC Handle Grip Material
- DIN 5231 D



541-7059 250mm
541-7116 300mm

Soft Jaw Utility Pliers

- Adjustment is easy because of a sprung adjuster mechanism, which also prevents the adjusted pliers slipping to another position
- Nylon replaceable jaws are available separately as a set of two on 734-012



734-006 Water Pump Pliers, 250 mm Overall

Water Pump Pliers

- Pliers made from chrome-vanadium steel
- Powerful and robust multiple slip-joint pliers
- Self-locking pliers with anti-slip action
- Narrow jaw profile
- Non-slip grips and hardened jaws.



668-5900 250mm DRV handle
668-5938 250mm

300mm Circlip Plier Set

- 4 Piece Circlip Plier Quality Set for inserting and removing circlips
- Ergonomic Red PVC grip handles allow for easy and smooth action
- External Pliers have a sprung design to help handles open
- Supplied with a Foam Tool Module to ensure the tools are kept tidy
- Made from Chrome Vanadium Steel



833-5929 External Circlip Pliers (Straight with Spring), External Circlip Pliers (Bent with Spring), Internal Circlip Pliers (Straight), Internal Circlip Pliers (Bent)

Din Standard Circlip Pliers

- Fitted with red PVC vinyl dipped covered handles
- External types incorporate return springs
- Black oxidised finish



541-6781 Internal bent 3-10mm
541-6826 External straight 3-10mm
541-6753 Internal straight 3-10mm
541-6769 Internal straight 8-25mm

Interchangeable Multi-Position Circlip Pliers

- Cushion-grip handles and spring loaded for faster comfortable operation



541-7267 External 6.4-25.4mm
182-436 External/internal 6.4-48mm/6.4-25.4mm

Locking Pliers Set

- Locking pliers maintain constant gripping force
- The guarded release lever is an important safety feature
- Supplied in a plastic tool roll pouch
- Ease of storage and transportation



847-3762 Chrome Molybdeum Steel, 180mm, 3 Pieces - 10" & 7" Locking Pliers with built-in wire cutter, 6" Long Nosed Pliers
847-3768 Chrome Vanadium Steel, 250mm, 3 Pieces - 10" & 7" Locking Pliers with built-in wire cutter, 6" Long Nosed Pliers

SPANNERS, SOCKETS & WRENCHES

The RS PRO range provides you choice to cover a wide range of applications and tasks; complete kits, impact sets, 1/4 inch, 1/2 inch imperial & metric options across sockets, torx & hex drives, combination spanners, open ended, ring & ratchet spanners, nut drivers, and cabinet keys.

66 Pieces 1/4 Inch And 1/2 Inch Socket Set

- Chrome Vanadium for excellent strength and corrosion resistance
- Soft comfortable ratchet handles for reduced fatigue and a tighter grip
- Fitted case reduces lost parts
- Bit sizes marked directly on the holders for quick identification of missing bits
- Strong latches for secure closing
- 75 mm and 250 mm extension bar for hard to reach areas



817-9249 66 Piece Metric 1/2 in; 1/4" Standard Socket/Bit Set with Ratchet

Socket Bit Set

- 45 Piece hexagon, spline & TX bits with adaptors in a handy storage case



213-1011 45 Piece Metric 1/2 in; 3/8" Standard Socket/Bit Set

46 Pieces 1/4 inch and 3/8 inch Socket and Bit Set

- Chrome Vanadium for excellent strength and corrosion resistance
- Soft comfortable ratchet handles for reduced fatigue and a tighter grip
- Fitted case reduces lost parts
- Bit sizes marked directly on the holders for quick identification of missing bits
- 1/4 and 3/8 Inch drive options



817-9242 46 Piece Metric 1/4 in; 3/8" Standard Socket/Bit Set with Ratchet

61 Piece Socket Set, 1/2 In, 1/4 Inch, 3/8 Inch Square Drive

- Drive size of 1/2 in, 1/4 Inch and 3/8 in
- Square drive type
- Chrome finish
- Chrome vanadium steel material
- 61 Pieces



480-6880 Socket Sizes (4 x 14, 9 x 19, 9 x 24mm), Drive Sizes (1/2 in, 1/4", 3/8 in)

Impact Socket Sets

- Impact-rated 6-point chrome molybdenum sockets
- Storage case with labelled moulds for each size
- Exceed ANSI specifications, with two grease rings for grip
- Centre hole punched for extra depth, Z-Drive for strong grip
- Thin wall design with chamfered openings



137-0909 18 Piece Impact Socket Set, 1/2" Metric, 10 x 32mm

137-0908 8 Piece Air Impact Socket Set, 1/2" Metric, 12 x 24mm

6 Piece Imperial Socket Rail

- Low Profile impact sockets
- Allow access to tight spaces
- Ideal for automotive applications
- Industrial grade strength



125-0929 Impact

10 Piece Metric 1/2" Impact Socket Set, 6 point

- Professional quality
- Offers high torque without damage to fasteners
- Increased durability
- Chrome Molybdenum Steel
- Phosphate finish



125-3056

18 Piece Inch Drive Impact Socket Set

- 16 socket bits
- Adapter and extension arm included
- Professional quality
- Offers high torque without damage to fasteners
- Increased durability
- Chrome Molybdenum Steel
- Phosphate finish



125-3055 in. x 125 mm Pneumatic Extension Arm, in. Pneumatic Socket Adapter, (10-11-12-13-14-15-16-17-18-19-21-22-24-27-30-32 mm) in 6-point air sockets - Metric

Metric Socket Set

- Chrome Vanadium for excellent strength and corrosion resistance
- Soft comfortable ratchet handle for reduced fatigue and a tighter grip
- Extension bars for hard to reach areas
- Labelled with the corresponding items for quick and easy identification
- Sturdy case with strong latch for secure closing, easy storage and protection



817-9233 29 Piece Set - 12 x 1/4in Sockets: 4, 4.5, 5, 5.5, 6, 7, 8, 9, 10, 11, 12, 13 mm; 10 x 1/4in Bit Sockets - Slotted: 3, 4, 5.5, 7mm, Phillips: PH1, PH2, PH3, Pozidriv: PZ1, PZ2, PZ3

39 Piece Metric Socket And Bit Set

- Heat-treated, forged Chrome Vanadium Steel for durability
- 'Sure Drive' system prevents slipping of fasteners
- Comfortable, ergonomic 1/4" Ratchet handle
- Metal case with marked liner for easy part identification



623-6390 39 Piece Metric 1/4" Standard Socket/Bit Set with Ratchet

Bit/Socket Set

- Hardened Chrome Molybdenum Steel bits
- Chrome Vanadium Steel nuts with zinc alloy
- Chrome-plated bit holder, sandblasted finish
- Innovative case for easy access and transport
- Kit includes various drivers, sockets, and screwdriver heads



213-1005 30 Piece Set - Bit Holder (1), Bits (20), Screw Finders (2), Sockets (7)

52 Piece Metric 1/4 Inch Deep Socket/Standard Socket/Allen Key/Bit Set With Ratchet

- High-quality square 6-point metric socket set and hex keys
- Steel construction for strength and durability
- Bright red foam for quick part identification
- Comfortable reversible quick-release ratchet handle
- Long arm L-shaped key set in plastic caddy for easy storage
- Foam tool modules designed for easy removal from drawers



833-5935 52 Piece 1/4" Drive Socket and Hex Key Set

16 Piece Square Drive Metric Socket Set

- Manufactured from Chrome Vanadium for excellent strength and corrosion resistance
- Ergonomically designed soft comfortable handles for reduced fatigue and a tighter grip
- Ratchet with quick release with red/black double injection grip
- 75 mm extension bar for hard to reach areas, the extension gives a longer reach



623-6413 12 Chrome Vanadium Steel sockets (Metric sizes 4, 4.5, 5.5, 6, 7, 8, 9, 10, 11, 12, 13 mm), Ratchet handle, 75 mm extension and universal joint, Spinner Handle with inch drive recess

Metric 6 Point Socket Set

- Made from chrome vanadium steel
- Hardened and tempered and chrome plated for corrosion protection
- Set supplied on a socket rail retaining bar, which may be wall mounted or used inside a tool box compartment in a roller cabinet



499-2543 10 Piece Metric 1/4" Deep Socket Set , 6 point

12 Piece Socket Set, 1/4 Inch Square Drive

- Drive size of 1/4 in
- Square drive type
- Chrome finish
- Chrome-vanadium steel material
- Socket set type



487-113 12 Pieces

7 Piece 1/4 Inch Bit Socket Set, Torx Bit

- Bits and sockets are made from a high-grade chrome molybdenum vanadium steel
- Heat treated to HRC: 56 □ 62
- Suitable for use with power tools
- Supplied with a socket rail and socket clips



262-0268 7 Piece 1/4" Bit Socket Set , Torx Bit

46 Piece Screwdriver & Socket Set

- High torque reversible ratchet drive with a magnetic shaft, fitted with cushion grip handle and internal bit storage compartment
- Chrome plated bit driver shaft
- Sandblast finish for bits double injection grip
- All bits and sockets are manufactured from high-grade alloy steel with a rust-resistant finish and are supplied in removable plastic clips to prevent loss
- 1/4 Inch square drive adaptor included



623-6441 1/4" Hexagonal reversible ratchet bit driver, 1/4" Dr. shallow sockets (imperial 3/16", 1/4", 5/16", 11/32", 3/8", 7/16", Metric 6,7,8,10,11,13 mm), 25mm length S2 Bits (Slotted 3, 4, 4.5, 5, 5.5, 6, 7 mm, Phillips #0, 1, 2, 3, Pozidriv #0, 1, 2, 3, Hex 1.5, 2, 2.5, 3, 4, 5, 5.5, 6mm, Tamperproof Torx: T8, 10, 15, 20, 25, 27, 30, 40), 25mm socket adaptor

60 Piece 1/4" Drive Imperial/Metric Socket Set

- Imperial and Metric Sets
- Quick-release reversible ratched and accessories
- Durable PP copolymer injection moulded case
- EVA high density foam inserts



224-2248 Quick release reversible ratchet; bit holder socket; 50mm extension bar; 150mm extension bar; 150mm spinner handle; universal joint; 115mm sliding t-handle; 6-point socket x11; 12-point socket x9; 6-point deep socket x6; 12-point deep socket x6; Slotted bit x3; Phillips bit x2; pozidriv x2; torx x6; hex bit x4; hex I key x4

8 Piece Socket Set, Inch Hexagon Impact Drive

- Ensure a secure hold, regardless of the application
- Ring magnet allows for secure holding
- Colour coded for easy identification
- Chrome vanadium material ensures strength and durability
- Supplied in a convenient case



180-7090 1/4" Hex Bit Socket Set , 65mm Nut Driver 6mm, 7mm, 8mm, 9mm, 10mm, 11mm, 12mm, 13mm

Tamperproof Bit Sets

- Made with the highest-quality materials to ensure the operator a long and safe service -Bits are chrome molybdenum vanadium steel and socket body are chrome vanadium steel
- Supplied with a socket rail and a socket clips



262-0202 11 Piece set - 6, 8, 10 (TORX) 4, 6, 8, 10 (Spanner) No. 1, 2, 3, 4 (Triwing)
262-0218 6 Piece Set - Imperial 1/4" Bit Socket Set , Tamperproof Hex Bit 5/64, 3/32, 7/64, 1/8, 9/64, 5/32
262-0224 Set contents: Tx8, Tx10, Tx15, Tx20, Tx25, Tx30, Tx40

32 Piece Metric Socket Set, 1/2 Inch Square Drive

- Chrome Vanadium for excellent strength and corrosion resistance
- Soft comfortable ratchet handle
- Sizes marked directly on the holders
- Strong latch for secure closing
- Sturdy case for clear and easy storage



229-7278 32 Piece Metric 1/2" Deep Socket/Standard Socket Set with Ratchet, 6 point; 12 point

34 Piece 1/2" Drive Imperial/Metric Socket Set

- Imperial and Metric Sets
- Quick-release reversible ratched and accessories
- Durable PP copolymer injection moulded case
- EVA high density foam inserts



224-2250 Contains quick-release reversible ratchet, Bit holder socket, 125mm extension bar, 250mm extension bar, 200mm sliding t-handle, Universal joint, 6-point socket x 19, 12-point socket x 10, storage case with EVA foam insert

1/2 Inch Drive Metric Socket Set

- Chrome Vanadium for excellent strength and corrosion resistance
- Soft comfortable handles for reduced fatigue and a tighter grip
- 8-32mm sockets



817-9230 26 Piece Metric 1/2" Standard Socket Set with Ratchet, 6 point

12 Piece Metric Socket Set

- Drive size of 1/2 in
- Square drive type
- Chrome finish
- Chrome vanadium steel material 12 Pieces
- Contents include sockets and ratchet



668-5792 12 Piece Metric 1/2" Standard Socket Set with Ratchet, 12 point

1/2 Inch Socket & Wrench Set with Foam Module

- Steel construction for excellent strength and durability
- Soft comfortable reversible quick release ratchet handle for reduced fatigue and easy speedy bit replacement
- Supplied with a full accessory assortment for a complete kit
- Bright red foam helps identify missing parts quickly
- Foam tool modules are designed for regular easy removal from drawers



833-5950 2 x Extensions, 1 x Ratchet, 1 x Sliding T-Bar, 18 x Sockets, 1 x Universal Joint

3 Piece Imperial 1/2 Inch Wheel Nut Socket Set

- Impact-rated 6-point chrome molybdenum sockets
- Includes 3 alloy wheel sockets for 1/2-inch impact wrench
- Storage case with labelled moulds for each size
- Exceeds ANSI specifications, features two grease rings
- Center hole for extra depth, Z-Drive for stronger grip
- Thin wall design with chamfered openings



137-0910 3 Piece Imperial 1/2" Wheel Nut Socket Set

29 Piece 1/2in Torx, Hex & XZN Bit Socket Tool Module

- Steel construction for excellent strength and durability
- Soft comfortable reversible quick release ratchet handle for reduced fatigue and easy speedy bit replacement
- Supplied with a full accessory assortment for a complete kit
- Bright red foam helps identify missing parts quickly
- Foam tool modules are designed for regular easy removal from drawers



833-5957 8 x Short Torx Socket Bits (T20 to T60), 4 x Long Torx Socket Bits (T30 to T50), 7 x Short Hex Socket Bits (5 to 14mm), 4 x Long Hex Socket Bits (6 to 12mm), 5 x Short XZn Socket Bits (M05 to M12), 1 x Short L Hex Key (2.5mm)

13 Piece Deep Socket Set

- 13 Piece deep socket set
- Drive size: 1/2 in
- Professional quality
- Non-Impact
- Chrome mirror finish for easy cleaning
- Offers high torque without damage to fasteners
- Increased durability
- Chemical Resistant Foam



249-0349 10 x 24mm

1/2 Inch Square Drive Torx Bit Driver Sets

- Chrome Vanadium steel sockets with S2 screwdriver bits



262-0303 10 Piece 1/2" Bit Socket Set , Torx Bit

1/2 Inch Square Drive Hex Bit Sets

- Durable hex bits
- Bit adapters for use with 1/2 inch square drivers
- Supplied on a convenient mounting rail
- All bits are 100mm in length



262-0331 6 Pieces, HEX, 5 x 12mm

6 Piece Imperial Socket Rail

- Universal sockets in sizes: 9/16", 5/8", 11/16", 3/4", 13/16" and 7/8"
- Available as standard use or impact type



125-0928 9/16", 5/8", 11/16", 3/4", 13/16" and 7/8"

1/2 Inch Square Drive Torx Bit Driver Sets

- Hardened and tempered Torx (or Star) bit set for heavy duty use.
- Each set is supplied complete on a rail retaining bar which can be wall mounted or used within a roller cabinet storage box.
- Chrome Vanadium steel sockets with S2 screwdriver bits



262-0296 10 Pieces, Torx Bit

8 Piece Socket Set 1/2 Inch Square Drive

- Made from chrome vanadium steel
- Hardened and tempered and chrome plated for corrosion protection
- Set supplied on a socket rail retaining bar, which may be wall mounted or used inside a tool box compartment in a roller cabinet



262-0252 E10; E12; E14; E16; E18; E20; E22; E24

40 Piece Flexible Head Ratchet Set

- Durable high grade Steel construction
- Ergonomic, soft grip handle for comfortable handling and reduced user fatigue
- 2 extensions and compact bit set makes this an ideal all-in-one set for any job



253-166

41 Piece Imperial/Metric Socket Set, 3/8-Inch Hexagon Non-Impact Drive

- Imperial & Metric socket set
- Quick-release reversible ratchet and accessories
- Durable PP copolymer injection moulded case
- EVA high density foam inserts



224-2249 6-Point Deep Socket x4, 6-Point Socket x16, 12-Point Deep Socket x4, 12-point Socket x11, 75mm Extension Bar, 150mm Extension Bar, 200mm Sliding T-handle, Quick Release Reversible Ratchet, Spinner Handle, Universal Joint

3/8 Inch Drive Hex Bit Set

- Durable hex bits
- Bit adapters for use with 3/8in drivers and adapters
- Supplied on a convenient mounting rail
- All bits are 50mm in length



262-0319 Hex 3-12mm

12 Piece Socket Set, 3/8 Inch Square Drive

- Drive size of 3/8 in
- Square drive type
- Chrome finish
- Chrome-vanadium steel material
- 12 Pieces
- Contents include sockets and ratchet



668-5783 12 Piece Metric 3/8" Standard Socket Set with Ratchet, 12 point

3/8 Inch Drive Hex Bit Set

- Heavy-duty Torx bit set
- 11 Piece set
- 3/8 Inch Square driver adapter
- Durable S2 steel construction
- Neat rack holder



262-0274 Torx T8-60

13 Piece Socket Set, 3/8 Inch Square Drive

- Drive size of 3/8 in
- Square drive type
- Chrome finish
- Chrome-vanadium steel material



487-167 42 Piece Mechanical Tool Kit with Case

18 Piece Socket Set, 3/8 Inch Square Drive

- 3/8-inch square drive socket set
- Mirror chrome finish
- 18 Pieces
- 13 six-point sockets from 8 to 22 mm (excluding 9 mm and 20 mm)
- Includes 75 mm and 150 mm extension arms, one sliding T-bar, one universal joint and one reversible ratchet arm



125-3053 1/4in Torx Bits (T6, T8, T10), 1/4in Spanner Bits (4, 6, 8, 10mm), 1/4in Tri-wing (TW1, TW2, TW3, TW4)

1/2 Inch & 3/8 Inch Square Drive Double Hexagon Sockets

- Double Hex/Bi-Hexagon Sockets with 12 angles
- Non impact sockets
- Smooth sandblasted finish
- Knurled grip



- 830-4094** 1/2" Square Drive, 10mm
- 830-4098** 1/2" Square Drive, 11mm
- 830-4108** 1/2" Square Drive, 12mm
- 830-4101** 1/2" Square Drive, 13mm
- 830-4105** 1/2" Square Drive, 14mm
- 830-4114** 1/2" Square Drive, 15mm
- 830-4117** 1/2" Square Drive, 16mm
- 830-4111** 1/2" Square Drive, 17mm
- 830-4120** 1/2" Square Drive, 18mm
- 830-4123** 1/2" Square Drive, 19mm
- 830-4127** 1/2" Square Drive, 20mm
- 830-4139** 1/2" Square Drive, 22mm
- 830-4133** 1/2" Square Drive, 23mm
- 830-4142** 1/2" Square Drive, 24mm
- 830-4082** 1/2" Square Drive, 8mm
- 830-4091** 1/2" Square Drive, 9mm
- 830-4032** 3/8" Square Drive, 10mm
- 830-4041** 3/8" Square Drive, 11mm
- 830-4044** 3/8" Square Drive, 12mm
- 830-4048** 3/8" Square Drive, 13mm
- 830-4057** 3/8" Square Drive, 14mm
- 830-4050** 3/8" Square Drive, 15mm
- 830-4054** 3/8" Square Drive, 16mm
- 830-4063** 3/8" Square Drive, 17mm
- 830-4066** 3/8" Square Drive, 18mm
- 830-4060** 3/8" Square Drive, 19mm
- 830-4079** 3/8" Square Drive, 20mm
- 830-4072** 3/8" Square Drive, 21mm
- 830-4076** 3/8" Square Drive, 22mm
- 830-4085** 3/8" Square Drive, 23mm
- 830-4088** 3/8" Square Drive, 24mm
- 830-4035** 3/8" Square Drive, 8mm
- 830-4038** 3/8" Square Drive, 9mm

1/2 Inch Drive Impact Socket Hexagon

- Chrome Molybdenum Material
- Thick walls prevent breakage
- For use with 1/2 Inch impact wrenches
- PCL branded with sizes printed clearly on body of socket



- 137-0915** 13mm
- 137-0924** 17mm
- 137-0918** 17mm
- 137-0919** 19mm
- 137-0925** 19mm
- 137-0920** 21mm
- 137-0926** 21mm
- 137-0921** 22mm
- 137-0922** 24mm

1/4 Inch Square Drive Hexagon Sockets

- Non impact sockets
- Smooth sandblasted finish
- Knurled grip



- 830-4016** 1/4" Square Drive, 10mm
- 830-4010** 1/4" Square Drive, 11mm
- 830-4029** 1/4" Square Drive, 12mm
- 830-4022** 1/4" Square Drive, 13mm
- 830-4026** 1/4" Square Drive, 14mm
- 830-3997** 1/4" Square Drive, 4.5mm
- 830-3988** 1/4" Square Drive, 4mm
- 830-3994** 1/4" Square Drive, 5.5mm
- 830-3990** 1/4" Square Drive, 5mm
- 830-4007** 1/4" Square Drive, 6mm
- 830-4000** 1/4" Square Drive, 7mm
- 830-4004** 1/4" Square Drive, 8mm
- 830-4013** 1/4" Square Drive, 9mm

Ring Spanner

- Manufactured to ANSI standard from Chrome Vanadium Steel with a bright Chrome finish
- Metric sizes



495-3879	12 x 13mm
495-3891	16 x 17mm
495-3908	17 x 19mm
495-3942	21 x 23mm
495-3958	22 x 24mm
495-3964	30 x 32mm

Combination Spanner - Straight

- Ratcheting ring end
- Flat pattern
- 31CrV3 steel
- Mirror chrome finish



192-3707	8mm, Metric, 136 mm Overall
192-3709	11mm, Metric, 168 mm Overall
192-3712	14mm, Metric, 193 mm Overall
192-3713	17mm, Metric, 233 mm Overall
192-3714	19mm, Metric, 250 mm Overall

Adjustable Spanners

- High quality, phosphate finish
- Precision-hardened, anti-corrosion finish
- Manufactured to ISO6787 standards
- These spanners incorporate 15° angled head with thin parallel jaws



541-6573	20mm / 6"
541-6589	26.8mm / 8"
541-6595	30mm / 10"
541-6602	34mm / 12"

Strap Wrench

- PVC handle material
- Plastic handle type
- Steel strap material
- Strap wrench type



144-7965	101.6mm Jaw Capacity
----------	----------------------

Combination Spanner Ratchet Head

- Ideal for awkward and hard to reach areas thanks to the 180° movement of pivot-head
- Manufactured to ANSI Standard
- Chrome Vanadium Steel with a bright Chrome finish



487-189	8mm
487-220	10mm
487-185	11mm
487-264	13mm
487-218	17mm
487-214	19mm

Ring Spanner

- Manufactured to ANSI standard from Chrome Vanadium Steel with a bright Chrome finish
- Metric sizes



495-3879	12 x 13mm
495-3891	16 x 17mm
495-3908	17 x 19mm
495-3942	21 x 23mm
495-3958	22 x 24mm
495-3964	30 x 32mm

C Hook Wrenches

- High-quality 6 Piece set, supplied complete in a PVC wallet
- Chrome plated with mirror finish
- Heat treated to HRC 42 to 48 Degrees



449-9864	6 Pieces, 8 x 19 mm
----------	---------------------

C Hook Wrenches

- Adjustable C hook wrenches for use in a wide range of maintenance and repair applications
- Thin profile for working in hard to access narrow spaces
- Drilled hole for lanyard attachment or easy storage
- Black finish



828-0239	19-51mm
828-0248	32-76mm
828-0241	51-120mm
828-0245	Chain adjust wrench

Open Ended Spanner

- Manufactured to ANSI standard from Chrome Vanadium Steel with a bright Chrome finish



495-3784	6 x 7mm
495-3807	8 x 9mm
495-3841	8 x 10mm
495-3699	10 x 11mm
495-3706	12 x 13mm
495-3712	14 x 15mm
495-3728	16 x 17mm
495-3813	17 x 19mm
495-3734	18 x 19mm
495-3740	20 x 22mm
495-3756	21 x 23mm
495-3829	22 x 24mm
495-3835	24 x 26mm
495-3762	24 x 27mm
495-3778	30 x 32mm

Combination Ratchet Spanner

- Metric ratcheting combination spanners
- Manufactured to ANSI from Chrome Vanadium Steel
- Bright Chrome finish



487-208	8mm
487-056	10mm
487-034	13mm
487-038	17mm
487-044	19mm
487-040	22mm
487-270	24mm
487-286	30mm

Combination Spanner

- Manufactured to ANSI standard from Chrome Vanadium Steel with a bright Chrome finish



495-3655	6mm, Metric, 124 mm Overall
495-3661	7mm, Metric, 129 mm Overall
495-3677	8mm, Metric, 136 mm Overall
495-3447	10mm, Metric, 161 mm Overall
495-3453	11mm, Metric, 168 mm Overall
495-3475	13mm, Metric, 180 mm Overall
495-3481	14mm, Metric, 193 mm Overall
495-3504	16mm, Metric, 207 mm Overall
495-3510	17mm, Metric, 227 mm Overall
495-3532	19mm, Metric, 250 mm Overall
495-3548	20mm, Metric, 260 mm Overall
495-3560	22mm, Metric, 295 mm Overall
495-3582	23mm, Metric, 295 mm Overall
495-3605	27mm, Metric, 362 mm Overall
495-3611	30mm, Metric, 394 mm Overall
495-3627	32mm, Metric, 429 mm Overall
495-3649	36mm, Metric, 510 mm Overall

Combination Spanner - Matt Chrome

- DIN 3113, ISO 7738
- Ring end off set from shaft at 15°
- 31CrV3 steel
- Mirror chrome finish



192-3691	6mm, Metric, 110 mm Overall
192-3692	7mm, Metric, 110 mm Overall
192-3694	9mm, Metric, 130 mm Overall
192-3695	10mm, Metric, 140 mm Overall
192-3696	11mm, Metric, 150 mm Overall
192-3697	12mm, Metric, 160 mm Overall
192-3698	13mm, Metric, 170 mm Overall
192-3699	14mm, Metric, 180 mm Overall
192-3700	15mm, Metric, 190 mm Overall
192-3701	16mm, Metric, 200 mm Overall
192-3702	17mm, Metric, 210 mm Overall
192-3703	18mm, Metric, 220 mm Overall
192-3705	21mm, Metric, 250 mm Overall
192-3706	22mm, Metric, 260 mm Overall

Universal Control Cabinet Key

- JointKey
- 360° rotating cross key heads
- Drive identification marking
- Twist mechanism for different profiles
- Forms to a T-handle with higher torque
- Made of die-cast zinc and reinforced fibreglass plastic
- Dimensions: 130 x 38 mm



228-1569 13 in 1, Square socket (sizes: 5 mm, 6 mm, 7 mm, 8 mm, 9 mm), Triangle socket (sizes: 6 mm, 7 mm, 8 mm, 9 mm, 10 mm), Two Way Key: 3 - 5 mm, 1/4 in. Square, 1/4 in. Hexagon for bits

228-1568 8 in 1, Square socket (size: 5 mm, 6 mm, 7 mm, 8 mm), Triangle socket (size: 7 mm, 8 mm, 9 mm), Two Way Key: 3 - 5 mm

Universal Switch Key Wrench

- Compact, yet durable tool designed for use with a wide range of applications including locking systems and valves



439-3019 Chrome finish

439-3025 Zinc alloy finish

Universal Cabinet Cross Wrench Key

- Designed to operate the locking mechanisms of a wide range of systems including gas, electric and water cupboards as well as technical equipment including air conditioning, stop valves and mains consoles



841-7005 Aluminium 4-Way Control Cabinet Key

Die-Cast Zinc Key

- Die cast zinc double bit key
- For use with quarter-turn cam locks



192-9656 Die Cast Key

Universal Double-Key Box

- Cabinet keys and in bits
- Multifunctional universal key box
- Large opening angle for good removal of the inserts
- Drive identification marking
- Ergonomically shaped for better handling
- Double-Key Length: 110 mm
- Weight: 165 g
- Fits nicely in your pocket or tool bag



228-1570 Fibre Reinforced Plastic 4-Way Universal Key

5 Piece Nut Driver Set

- Ergonomically designed handle, optimising balance between comfort and torque
- Comfortable soft grip
- Chrome Vanadium Steel, Matt Chrome
- EVA module

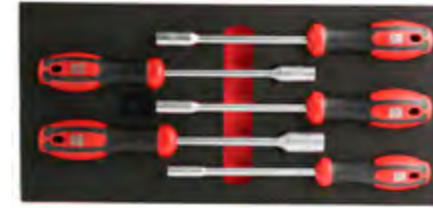

125-3062 Hex Nut Driver Set, 6 mm, 7 mm, 8 mm, 10 mm, 13 mm Tip, 125 mm Blade, 225 (6 mm C-PLUS Nut Driver) mm, 235 (10

7 Piece Nut Spinner Set

- Ergonomically designed handle, optimising balance between comfort and torque
- Comfortable soft grip



460-1758 Nut Driver Set, 4, 5, 5.5, 6, 7, 8, 10mm Tips, 226 mm Overall

Ball Joint Nut Splitter

- The parallel action of the cutter cracks nuts on one side, without damage to bolt threads
- Angle design with 360° rotating cutter allows use in difficult to reach locations
- Drop forged frame. Length 6 1/4 Inch for use on nuts with 1/8 in to 15/16 in across flats.



618-8831 Nut Splitter For Nut Sizes 1/8 - 15/16 in

Nut Splitter

- Make it easy to cut seized nuts with this splitter from RS PRO. It's typically used to remove rusted, damaged or frozen nuts that are hard to disassemble.
- Supported nut sizes of up to 9/16 in Withworth, 5/8 in BSF (British Standard Fine) and 1 in AF (across flats)



539-570 Nut Splitter For Nut Sizes Up to 9/16 in Withworth, 5/8 in BSF, 1 in AF in

Hydraulic Nut Splitter Kit

- Hydraulic nut splitter kit
- 10-ton hydraulic ram and ram attachment
- 5 cutting blades suitable for 3/8-inch, 1/2-inch, 5/8-inch, 3/4-inch and 1-inch nut sizes
- Plastic oil bottle
- Supplied with a red carry case
- Complies with ANSI/ESD S20.20:2014 and BS EN 61340-5-1:2007 Electrostatic Control Standards



423-6691 Nut Splitter For Nut Sizes 3/8" - 1-7/8"

6 Piece Miniature Nut Spinner Set

- Miniature metric nut drivers
- Black anodized Carbon Steel blades
- Nickel plated Chrome Vanadium handles
- Hardened socket to 47 - 56 HRC
- Revolving heads
- Tommy bar included
- Supplied in plastic ABS case



541-6882 Nut Driver Set, Hexagon Tip, 3.0 x 25mm (Green), 3.5 x 25mm (Purple), 4.0 x 25mm (Brown), 4.5 x 25mm (Blue), 5.0 x 25mm (Dark Green), 1 x Tommy Bar

Soft Feel Handle Nut Spinners

- Ergonomically designed comfort grip handles
- Hardened steel heads



499-2357 10mm

499-2391 4mm

499-2341 5.5mm

499-2379 5mm

499-2385 6mm

499-2329 7mm

499-2335 8mm

Standard Handle Nut Spinners

- Solid, red plastic (cellulose acetate), fluted design handle offers a comfortable and safe grip and it is securely fitted to the shaft



460-1742 10mm

460-1691 5.5mm

460-1685 5mm

460-1708 6mm

460-1720 7mm

460-1736 8mm

Drive Quick Release Reversible Ratchet Handle

- 48-tooth strong mechanism
- Switch pawl allowing the ratchet to be used in reverse
- Quick release allowing sockets to be changed quickly and efficiently
- Chrome vanadium steel for enhanced durability
- Soft grip handle for enhanced user comfort and control when in use



189-1329	1/2", 150 mm length
194-4594	1/4", 150 mm length
194-4595	3/8", 200 mm length

Dial Torque Wrench

- Manufactured to ISO6789
- Easy to read SI and Imperial unit analogue dial
- Clockwise and anti clockwise measurement is possible with double ended ratchet as standard
- Accuracy +/- 3% of reading



575-633	0.3-4Nm 1/4in drive
815-521	20-215Nm 1/2" drive
815-515	6-80Nm 1/2" drive
575-649	8-40Nm 3/8" drive

Square Ratches with Ratchet Handle

- Maintenance-free 1/2" sealed ratchet head
- Ultra-compact square drive fits metric/imperial sockets
- Reversible switch for quick direction change
- Ergonomic soft-grip handle for superior comfort
- Chrome Vanadium Steel for durability



253-116	1/2"
253-419	1/4"
253-172	3/8"

Drive Ratchet Handle

- Square drive shape
- Drive size of 1/4 in
- Chrome finish
- Extendable ratchet handle type
- Chrome-vanadium steel material
- Overall length of 200 mm



668-5846	1/2" extendable
668-5834	1/4" extendable handle
668-5843	3/8" extendable handle

Mini Head Reversible Ratchet Handle

- Ratchet mechanism is reversible with all critical parts
- Heat treated for strength and durability
- Manufactured from Chrome-Vanadium Steel
- Black Chrome finish



668-5786	3/8" Ratchet Spanner, Square
----------	------------------------------

72 Teeth Ratchet Handle

- Made from high grade alloy steel
- Ergonomically designed
- 72 teeth
- Ideal for industrial use



912-5417	1/2"
912-5404	1/4"
912-5408	3/8"

'Breaking' Ratchet Handle

- Designed to 'break' at a predetermined torque value, clockwise or anti-clockwise
- Reset by returning to in-line position
- Ideal for use in low torque applications, production or in restricted spaces



663-881	0.2-2Nm
663-897	1-10Nm

RIVET GUNS

The RS PRO range of riveters is designed to provide a range of high quality tools to meet your material joining needs, in all industries from, construction, carpentry, upholstery, paper and packaging, automotive to fabrication.

Plier Type Hand Rivet Gun

- Durable aluminium body construction offering corrosion resistance and durability
- Ideal for use with aluminium, steel and stainless steel rivets
- 4 interchangeable nose Pieces to accommodate different size rivets - can be used with rivet sizes 2.4, 3.2, 4.0 & 4.8 m
- Spanner included to quickly change nose Pieces
- Forged steel handle with ergonomic grip for comfort and control



192-3666 Hand Rivet Gun For 2.4, 3.2, 4.0, 4.8 Mm Rivets

5 Piece Hand Riveter Set

- Hand riveter and rivets (20 mm x 2.4 mm, 20 mm x 3.2 mm, 20 mm x 4.0 mm, 20 mm x 4.8 mm)
- Foam inlay storage type
- This product is not VDE approved



833-5969 5 Piece Hand Riveter Set

360° Swivel Head Riveter

- Manufactured from chrome steel with hardened steel jaws
- Capable of riveting at any angle through 360°
- Fitted with soft-grip rubber handles



487-141

Standard Riveter

- High-quality steel handles & body
- Case-hardened steel nose
- Rivet gripping action
- Suitable for 3.2 mm, 4 mm rivets
- Rivet head storage in handle
- Mandrel kit required for use with M3 fittings



487-157 Plier Type Rivet Tool

SCREWDRIVERS, HEX & TORX KEYS

RS PRO's wide range of screwdrivers, hex keys, and Torx keys, including Phillips, flathead, hexagon, and Torx screwdriver sets, offering versatile and reliable tools for various screwing and fastening tasks.

Screwdriver Sets

- Precision hardened Chrome-Vanadium-Molybdenum steel
- 6 Piece Screwdriver Sets
- Improved handle ergonomics
- High force transfer with less power
- Reduced strain during intensive use



- 125-3101** 4 x Slotted (3 x 0.75 mm, 4 x 100 mm, 5.5 x 125 mm, 6.5 x 150 mm), 2 x Phillips (PH1 x 80 mm, PH2 x 100 mm)
- 125-3102** 4x Slotted, 2 x Pozi

6 Piece Electronics Screwdriver Sets

- Designed for delicate precision engineering and electronics applications.



- 125-3107** 4 x Slotted (1.5 x 40 mm, 2.0 x 60 mm, 2.5 x 80 mm, 3.0 x 80 mm) & 2 x Pozidriv (PZ00 x 60 mm, PZH0 x 60 mm)
- 125-3106** 4 x Slotted (H01: 1.5 x 40 mm, H01: 2.0 x 60 mm, H01: 2.5 x 80 mm, H01: 3.0 x 80 mm) & 2 x Phillips (H02: PH00 x 60 mm, H02: PH0 x 60 mm)
- 125-3108** 6 x Torx Screwdrivers (T5, T6, T7, T8, T9, T10)

9 Piece Soft Feel Torx Driver Set

- Set consists of T6 to T30
- Zinc blasted and lacquer finished, hardened steel
- Supplied in a zipped wallet



- 499-2408** Torx Insulated Screwdriver Set, 9-Piece

Slotted Screw Gripping Screwdrivers

- Blades have a sliding sleeve operated by a plastic collar (just below the handle) which, when pushed down, causes the blade tip to split apart and firmly wedge against the sides of the screw slot.
- Blade thickness is defined in the released condition



- 547-953** 3in 0.02in tip
- 547-975** 6in 0.031in tip
- 547-969** 8in 0.02in tip
- 547-981** 8in 0.037in tip

Classic Screwdrivers

- Chrome vanadium steel blades
- Cellulose acetate handles
- Slot drive screwdrivers with chemically blackened, lacquered blades
- Supadriv™ and Phillips blades with blackened tips, chromium plated
- Torque and gauge tests meet DIN standard
- Screwdriver blades heat treated to HRC 55-60°



- 736-131** 300x8mm

Penknife Hexagonal Sets

- Metric and imperial sets of hexagon keys which fold into a convenient penknife style handle
- Keys have blackened finish, steel handle is bright zinc-plated



- 451-8993** 7 Piece metric, 1.5mm, 2.0mm, 2.5 mm, 3 mm, 4 mm, 5 mm, 6 mm
- 314-2977** 7 Piece metric, 2.5 mm, 3 mm, 4 mm, 5 mm, 6 mm, 8 mm, 10mm
- 537-754** 9 Piece imperial long arm, 5/64 > 1/4in
- 451-9003** 9 Piece imperial short arm, 0.05 > 3/32in
- 537-760** 9 Piece metric, 1.5 > 8mm

L-Shape Hex Key Miniature Set

- Made from chemically blackened, chrome vanadium steel
- High-quality materials ensure long and safe service
- The set is supplied in handy compartmental plastic wallet
- 8 Piece set contains 0.7-4mm sizes



- 450-1002** 0.7 > 4mm

Plastic Holder Sets

- Short arm L-shaped hexagon key sets in tempered chrome-vanadium steel, with chemically blackened finish
- Contains 10-Pieces 1.5-10mm, supplied in plastic holder



- 537-748** 10 Piece L Shape Metric Hex Key Set, 1.5 > 10mm

L Shaped Hex Key Set

- Ball-Plus™ hex keys permit an entry angle up to 25° to work in hard-to-reach areas
- Covers sizes from 1.27mm to 10mm



- 542-3509** 15 Piece 1.27-10mm
- 542-3515** 9 Piece 1.5-10mm

Rack Mounted Driver Sets

- Available in metric or imperial each with bench mounting metal storage rack
- Keys manufactured from chrome-vanadium steel, with chemically blackened finish



- 537-811** Metric

Individual L-Shaped Ball Drivers

- Chemically blackened finish
- High quality, L shaped hex keys
- Long and short arm options across the range



- 735-059** 1.5mm
- 735-071** 2.5mm
- 735-065** 2mm
- 735-087** 3mm
- 735-093** 4mm
- 735-100** 5mm
- 735-116** 6mm

15 Piece Hey Key Set

- Long arm hex key set made for professional precision.
- Polished finish
- Supplied with a plastic caddy, making it super easy when needing to be transported and for "on the go" jobs



- 833-5913** Metric, T-handle (2, 2.5, 3, 4, 5, and 6 mm) & Ball End (1.5, 2, 2.5, 3, 4, 5, 6, 8 and 10 mm)

Tamperproof Screw Bits

- Hexagon shaft section (1/4 Inch across flats) which enables them to locate into 1/4 Inch square drive adaptor.



516-334	Bit 1/4in, M5
542-122	Bit No.1
542-116	Bit No.2

Screwdriver Bit Sets

- Manufactured from high grade alloy steel
- Suitable for use with power tools



615-9209	32 Piece assorted
615-9221	8 Piece Hexagon
615-9170	8 Piece Tamperproof
615-9215	8 Piece Torx

Magnetic Easy Link/Easy Lock Bit Holder

- Inserting and removing the bit is possible with one hand motion
- 1/4 Inch hexagon shank
- 60mm long



125-0431 Bit Holder

Multi-Bit Screwdrivers

- Quick bit changes
- Strong durable Steel construction for long tool life
- Comfortable handle for extended use



241-7769	2-in-1 Stubby screwdriver
573-384	4-in-1 set with Interchangeable Bits

Impact Magnetic Nut Setter

- 1/4" hexagon shank
- 50mm long



125-0421	1/4 Inch
125-0417	10mm
125-0420	13mm
125-0414	6mm
125-0415	7mm
125-0416	8mm

Tamperproof Drivers

- Designed specifically to fit the System Zero® tamperproof screws.
- The drivers have a hardened steel head, forged shaft and Cellulose Acetate Fluted handles.
- High-quality materials ensure long life and safe operation even at the high torque.



516-344 ZE5 Handle Driver

Security Screwdriver Sets

- For use on all security Star type fasteners
- Supplied complete in a blow-moulded plastic storage case
- Manufactured from high grade chrome vanadium steel
- Set includes Torx Screwdrivers: T8, T9, T10, T15, T20, T25, T27, T30, T40 & Torx Keys: T8, T9, T10, T15, T20, T25, T27, T30, T400



499-2521 18 Piece Torx driver set

Magnetic Nut Setter

- 1/4" hexagon shank
- 50mm long



125-0400	5.5mm
125-0401	6mm
125-0402	7mm
125-0403	8mm
125-0404	9mm
125-0405	10mm
125-0406	11mm
125-0407	12mm
125-0408	13mm
125-0409	17mm

Tin Cvd Screw Bits

- 1/4 Hexagon Shank
- 25 mm long
- TiN CVT Coating



125-0356	Ph2
125-0359	Pz2
125-0361	Tx10
125-0362	Tx15
125-0363	Tx20

Extra Hard Pozidriv Screw Bits

- 1/4" hexagon shank
- 25mm long
- Extra hard coating



125-0335 PZ2

Torsion Phillips Screw Bits

- 1/4" hexagon shank
- 25mm long
- Longer torsion zone



125-0338	Ph2
125-0340	Pz1
125-0341	Pz2
125-0351	Slotted 4.5x0.6mm
125-0352	Slotted 5.5x0.8mm

Power Tool Cross Head Bit

- Long life bits with an extremely hard titanium nitride surface finish which absorbs torque peaks and prolongs bit life



449-9454	Phillips 90x1mm
449-9460	Phillips 90x2mm
449-9482	Pozidriv screwdriver bit, PZ1 90mm
449-9498	Pozidriv screwdriver bit, PZ2 90mm
449-9511	Pozidriv screwdriver bit, PZ3 90mm

Impact Screw Bits

- 1/4" Hexagon Shank
- 25 mm long



125-0379	PZ1
125-0380	PZ2
125-0381	PZ3

Torsion Phillips Screw Bits

- 1/4 Inch Hexagon Shank
- 25 mm long
- Longer torsion zone



125-0347	Tx30
125-0348	Tx40

Torx Tamper Screw Bits

- 1/4" hexagon shank
- 25mm long



125-0370	Tx10
125-0372	Tx20
125-0373	Tx25

Impact Screw Bits

- 1/4" Hexagon Shank
- 25 mm long



125-0382 Tx10

HAMMERS & MARKING TOOLS

RS PRO offers hammers and marking tools such as claw hammers, rubber mallets, chisels, marking pens, and scribes, providing effective striking and marking solutions for woodworking, metalworking, and general construction tasks.

Carbon Steel Ball-Pein Hammer With Fibreglass Handle

- Ball-pein hammer type
- Fibreglass handle material
- Carbon steel head material



125-0943	450g
125-0944	680g
125-0945	910g

Fibreglass Curved Claw Hammer

- Fibreglass construction with hardened steel
- Rubber grip handle for comfort
- Curved head aids in nail removal
- Durable and shock absorbent
- Reduces user fatigue



537-007	20oz
---------	------

Carbon Steel Hammer With Fibreglass Handle

- Carbon steel hammer
- Two tone colour (black and red) fibreglass handle
- Black satin finished
- High strength characteristics



125-0938	500g
125-0937	300g

Rubber Mallet

- Shock-absorbing ash wood handle
- Round rubber head for versatile use
- Comfortable for extended periods



539-104	550g
---------	------

Curved Claw Hammer

- Heat-treated 16oz medium carbon steel claw head
- Carbon steel tubular handle with black PVC molded casing
- Professional-grade durability and strength
- Versatile for various tasks



449-9858	16oz
----------	------

Lump Hammer

- Manufactured to BS876
- Black epoxy coated heads with polished convex faces
- Securely fitted and moisture-sealed, hickory shafts



251-542	4 lb
---------	------

Dot Number & Letter Punches

- Numbers and letters in one 36 Piece set
- Character and size marked on each stamp
- Hardness: HRC 58-60
- Hardened and tempered to give long life



875-4780	10.0mm
875-4777	3.0mm
875-4770	4.0mm
875-4774	5.0mm
875-4783	6.0mm
875-4786	8.0mm

27 Piece Letter & Number Punches Set

- 27pcs letter steel stamp, round type
- Letter: Capital A-Z (face) with Symbol: &
- Hand punches for permanent identification marking
- Hardened and tempered to give long life and maximum security
- Capable of indenting material up hardness



875-4718	2.5mm
875-4720	3.0mm
875-4733	4.0mm
875-4730	5.0mm
875-4742	6.0mm
875-4755	8.0mm

9 Piece Number Punches

- Hand punches for permanent marking of metal objects
- Capable of marking materials up to HRC 40 hardness
- Hardened and tempered for long life and maximum security
- Supplied in clearly marked sturdy plastic boxes



875-4714	2.5mm
875-4727	3.0mm
875-4724	4.0mm
875-4736	5.0mm
875-4749	6.0mm
875-4746	8.0mm

Parallel Punch Sets

- High-quality rivet punches forged from steel with a plastic storage case with size markings
- Chemically blackened finish offering prolonged life and corrosion resistance
- Manufactured using durable steel



875-4764	8 Pieces, 105mm / 4"
----------	----------------------

Spring Tension Pin Punch Sets

- 6 punches for inserting and extracting spring tension pins
- Raised pilot end for locating into pins
- Suitable for spiral wrapped spring tension pins
- Made from tool steel with hardened tips
- Supplied in vinyl wallet



626-1497	Punch set
600-896	Spring tension set

Letter & Number Punches

- Hand punches for permanent marking of metal objects
- Capable of marking materials up to HRC 40 hardness
- Hardened and tempered for long life and maximum security
- Supplied in clearly marked sturdy plastic boxes



251-738	3mm, A - Z, &
251-801	4mm, A - Z, &
251-687	5mm, A - Z, &
251-788	6mm, 0 - 9
251-693	6mm, A - Z, &
251-794	8mm, 0 - 9
251-744	8mm, A - Z, &

Combination Punch Set

- Made of tool steel
- Black oxide finish for rust prevention
- Knurled body for better grip
- Points precision ground
- Supplied in fitted case



875-4758	3 Pieces, 105mm / 4"
----------	----------------------

Parallel Pin Punch Sets

- High-quality rivet punches forged from chrome-vanadium air-hardened steel, in plastic stand
- Multi-coating of impact head virtually rules out chipping and swelling
- Polished cylinder shanks
- Tools are 150mm in length
- Octagonal, gold-painted grip shanks



505-8688	6 Pieces, 150mm, Sizes 2, 3, 4, 5, 6, 8mm
456-3640	6 Pieces, 150mm, Sizes 3, 4, 5, 6, 8, 10mm

Scribes

- Tungsten Carbide tipped scribes are intended for use on hard or abrasive materials which would rapidly blunt ordinary HSS scribes, e.g. stainless steel, anodised aluminium, ceramic, glass, etc.
- Single and double ended options



394-184	Double tipped
394-194	Retractable fine point
394-190	Straight

POWER TOOLS, SOLDERING & WELDING

RS PRO provides power tools such as drills, grinders, soldering irons, welding machines, and welding accessories.

Solder Sucker De-soldering Gun

- Hand operated solder sucker, desoldering gun
- Standard model
- Provides efficient solder removal and joint dis-assembly
- Fast sucking action via the spring loaded piston
- Extraction springs are outside of the vacuum chamber
- Prevents solder sticking



479-4197 56GM

479-4204 Spare PTFE Micro Nozzle (polytetrafluoroethylene)

479-5768 Spare washer

Anti-Static Solder Sucker De-soldering Gun

- Solder sucker, desoldering gun
- Anti-static standard model, hand-operated
- Efficient solder removal with spring-loaded piston
- Outside extraction springs prevent solder sticking
- PTFE nozzle, polished aluminum body for conduction



557-878 190mm

Desoldering pump

- Knurled main body section for better hand grip
- Easy access release control button



771-9543

Butane Gas Blow Torch

- Piezo electronic ignition system
- Infinitely adjustable flame temperature
- Ideal for brazing, soldering, plumbing and maintenance



199-270 Gas Blow Torch Only

Solder Sucker

- Plunger-style, hand operated solder sucker with soft, non-slip handle
- Piston with double oil seals to guarantee no air leakage
- Replaceable nozzle
- Anti-static design



146-5244 210 mm

Anti-Static De-Soldering Gun Pump Solder Sucker.

- Hand-operated solder sucker for efficient desoldering
- Anti-static, fast sucking action with dual spring-loaded piston
- No air leakage, powerful vacuum, replaceable tip
- Aluminium body, anti-fatigue grip, easy to use
- Non-clogging self-cleaning nozzle, with replacement option



151-3012 195mm

Lead-Free Solder Wire

- Resin-based, SAC305 lead free solder wire that utilises a synthetically refined resin and effective activator package
- The alloy used in this solder wire conforms to J-STD 006 and contains 96.5% tin, 3.0% silver and 0.5% copper
- Melting point is 217-219°C



756-8884 0.7mm, 250g

756-8893 0.7mm, 500g

800-7677 0.8mm, 250g

800-7655 1.0mm, 250g

800-7630 1.0mm, 500g

800-7664 1.1mm, 250g

756-8913 1.2mm, 250g

60/40 Tin-Lead Alloy Solders

- Resin-based solder wire is a 60/40 tin/lead solder wire, with the solder flux formulated for wetting all common Printed Circuit Boards (PCBs) and components.



800-7661 0.7mm, 250g

756-8904 0.7mm, 250g

756-8900 0.7mm, 500g

179-6660 1.0mm 250G

800-7658 1.0mm, 250g

756-8881 1.2mm, 250g

179-6683 2.0mm, 250g

Soldering Helping Hand with LED Magnifier

- Includes 16 super bright and energy saving LED's
- The magnifier is on a flexible neck that gives you 2.5X (6D) and 4X (12D) magnification
- Magnifying Lens size: 90 Ø mm and 20 Ø mm
- The 3 adjustable helping hands clips allow for precise positioning and secure grip on your work
- The magnifier is powered by either 4 AA batteries or external power adapter



146-6439

Soldering Helping Hand with Magnifier

- Heavy iron base – base size 65 mm x 60 mm
- Adjustable clips – holds objects at any angle for precise positioning and secure grip on your work
- Comes with 2.5 x Ø 3-1/2 inches (90 mm) Acrylic lens magnifier and 4.5 X insert lens



146-6441

Solder Tip Cleaner

- For gentle fine clean of soldering tips
- Tip is cleaned by wiping or turning it in the metal wool. Subsequently, a fine solder layer will remain which prevents fast oxidation of the soldering tip, and represents a considerable advantage compared to standard sponge cleaning.
- Brass cleaning ball



136-8299 Black

136-8300 Replacement Iron Tip

Solder Reel Stand

- Rubber clad bottom plate with mounting holes
- Comes with carry handle
- Conforms to ANSI/ESD S20.20:2014 and BS EN 61340-5-1:2007 Electrostatic Control Standards



144-6538 Holds 1 kg Solder Reels, 78 mm (L) x 86 mm (W) x 14 mm (H)

Soldering Tips

- Range of copper solder tips for use with RS PRO digital solder station



799-8954 0.25mm Conical Sharp

799-8976 0.2mm Conical Sharp

799-8985 0.8mm Conical Chisel

799-8979 1.2mm Conical Chisel

799-8973 2.4mm Conical Chisel

799-8989 2mm 45° Conical Bevel

799-8982 3.2mm Conical Chisel

High-Speed Steel (HSS) Step Drill Bits

- High quality
- Reduced vibration
- Faster drilling rate



HSS Step Drills, De-burring

- Multi-Dia. cutters requiring no pilot hole to cut stainless steel, carbon steel, soft metals and plastic
- 3-flute cutting action provides accurate parallel holes in sheet material up to 3mm thick
- 3mm increments



- 123-8510 9 Steps, 4 to 12 mm, 6.5 mm shank
- 123-8513 10 Steps, 4 to 22 mm step drill 10 mm shank
- 123-8508 10 Steps, 6 to 30.5 mm, 10 mm shank
- 123-8509 12 Steps, 6 to 30 mm, 10 mm shank
- 123-8515 12 to 25 mm Clearance & Tapping step drill
- 123-8511 13 Steps, 5 to 35 mm, 13 mm shank
- 123-8514 16 to 25 mm conduit entry step drill
- 123-8512 16 to 32 mm conduit entry step drill

- 232-529 8 to 41 mm Drill Bit, 11 Steps, 5 mm Max Drilling Thickness
- 232-507 6 to 36 mm Drill Bit, 11 Steps, 5 mm Max Drilling Thickness
- 232-513 7 to 37 mm Drill Bit, 11 Steps, 5 mm Max Drilling Thickness

170-Piece HSS-TiN Coated Jobber Drill Set

- High-speed steel titanium-coated drills in various popular sizes from 1.0mm to 10mm drill bits in 0.5mm increments
- Ground flute for precise drilling
- Heavy-duty steel case with molded insert for secure storage



507-1732 170 PCS

Bi-metal hole saws

- Hardened cutting edge welded to a tough alloy steel body
- For use with ferrous and non ferrous metals, plastics and wood to a depth of 32mm
- 14-30mm dia saws require a 6.5mm arbour
- 32-152mm dia saws require a 9.5mm arbour



- 215-978 9.5mm Arbour
- 215-990 Pilot drill bit, 6.5 mm

Thinwall Hole Saw Kits

- Choice of Thinwall and TCT hole cutter kits
- Use on multiple materials - wood, thin sheet metal and plastic



918-6409 7-Piece

Cobalt Jobber Drill Sets

- HSCo (5%) jobber drills for use on alloy steel, hardened steel, stainless steel, cast iron and titanium
- 135° split point



- 216-678 19-Piece 1-10mm
- 216-690 25-Piece 1-13mm

Jobber Drill Sets

- Ground flute High Speed Steel jobber drills
- Ideal for general workshop or maintenance use where high precision and productivity are not required
- Housed in a steel case



- 507-1704 19-Pieces 1-10mm
- 212-941 25-Piece 1-13mm

HSS TiN Coated Drill Bits

- Titanium Nitride Coated (TiN)
- Longer shaft length
- Right angle cutting tip
- 118° cutting angle
- Available in sizes from 0.25 - 20mm
- Suitable for metals, woods, plastics



- 213-411 3.0mm
- 213-304 3.5mm
- 213-922 2.5mm
- 213-203 5.0mm

Carbide Hole Saw Set

- Tungsten Carbide tipped hole saws give you outstanding cutting performance and product durability
- For use on multiple materials including stainless steel, mild steel, copper and brass sheets



- 673-4718 20mm
- 673-4712 22mm
- 673-4724 32mm

Metric HSS Twist Drill Bits

- Perfect for general purpose workshop and maintenance drilling work
- High Speed Steel (HSS) construction, ideal for use with power tools
- Black finish for corrosion and wear protection



213-089 2.5mm

HSS Cobalt Jobber Drills

- Plan Shank
- Various lengths
- Cobalt (5%)
- HSS for performance and safety
- Perfect for general workshop and maintenance use



- 216-656 2.5mm
- 216-482 3.3mm
- 216-583 5.0mm

Rolled Forged

- Rolled Flute; Copper Brazed Percussion Grade Carbide Tip
- Straight Shank



- 215-057 6mm Dia. x 400mm
- 215-192 10mm Dia. x 150mm LG

Micro HSS Drill Bit Set

- Versatile set with micro drill bits in a variety of sizes
- Perfect for use with a range of materials including plastic, wood, aluminium, glass fibre and more
- Ideal for producing clean and precise holes
- Supplied in a plastic storage case with sizes printed on to keep them organised



457-627 0.5 mm to 2.2 mm

HSS Jobber Drill Bit

- DIN338
- Fully Ground Drill
- 188o Point Angle



- 787-7330 0.40mm, 5 Pieces
- 787-7337 0.50mm, 5 Pieces
- 787-7349 0.60mm, 5 Pieces
- 787-7359 0.80mm, 5 Pieces

SANDING, FILING & POLISHING TOOLS

RS PRO sanding, filing, and polishing tools are essential to the any professional tradesperson's tool box. The range is designed to provide choice and flexibility for shaping, smoothing, and finishing all surface requirements.

Abrasives Selection Guide

Abrasives are essential tools in a variety of industries, from automotive manufacturing to woodworking and metal fabrication.

Choosing the optimum product is essential as using the wrong tool for a specific task can result in poor quality work, increased project time, and even safety hazards. This guide will help you choose the right abrasive product for your specific application, ensuring that your project is completed efficiently, effectively, and safely.

Grit Explained

The table shows typical grit grades for each stage of the application process. Grades are inversely proportional to grit size, so fine abrasives are higher grades using smaller sizes of grit.

COARSE (GRINDING)						FINE (FINISHING)						
GRIT	24	30	36	40	50	60	80	100	120	150 - 180	180 - 320+	
CUTTING-OFF AND GRINDING WHEELS	Cutting-off											
	Heavy Duty Grinding											
COATED ABRASIVES	Stock Removal											
							Blending & Refining					
							Sanding					
							Surface Preparation & Cleaning					
										Finishing		

Using the right tool for the job

Use this chart to help you choose the right abrasive product for your specific application, ensuring that your project is completed efficiently, effectively, and safely.

APPLICATION	TOOL											
	CUTTING DISC	DIAMOND BLADES	GRINDING DISC	GRINDING WHEELS	ABRASIVE BRUSHES	FIBRE DISCS	SANDING DISCS	FLAP DISCS	FLAP WHEELS	SANDPAPER ROLLS	ABRASIVE SHEETS	
CUTTING METAL	✓✓	✓										
MASONRY		✓✓										
GRINDING			✓✓	✓✓				✓✓				
STOCK REMOVAL					✓✓			✓✓	✓✓			
SANDING						✓✓	✓✓	✓✓				
HAND SANDING										✓✓	✓✓	
SURFACE PREPARATION			✓		✓✓	✓✓	✓✓	✓✓	✓	✓	✓	

BEST FOR APPLICATION ✓✓

ALTERNATIVE USE ✓



Wire Brushes

RS PRO's comprehensive range of wire brushes are tested to extremes to ensure maximum performance when used in industrial environments.



- 188-4097** 3 Piece Spindle Mounted Wire Brush Set - 50mm Wire Cup Brush, 50mm Wire Wheel, 25mm End Brush, 4,500rpm Maximum safe speed
- 136-9889** 3 Piece Steel Wheel Circular Brushes, 12,000rpm Max
- 188-4115** Crimped Wire Cup Brush, 12,500rpm, 75mm x M10
- 188-4127** Crimped Wire Cup Brush, 12,500rpm, 75mm x M14
- 188-4125** Crimped Circular Brush, 4,500rpm Max, 75mm
- 188-4108** Crimped Stainless Steel Circular Brush, 4,500rpm Max, 40 mm
- 188-4109** Crimped Stainless Steel Circular Brush, 4,500rpm Max, 70 mm
- 188-4103** Spindle Mounted Crimped End Brush, 20,000rpm Max, 10mm
- 188-4104** Spindle Mounted Crimped End Brush, 20,000rpm Max, 12mm
- 188-4099** Spindle Mounted Crimped Cup Brush, 4,500rpm Max, 55mm
- 188-4126** Spindle Mounted Crimped Cup Brush, 4,500rpm, 75mm
- 188-4117** Spindle Mounted Crimped Stainless Steel End Brush, 20,000rpm Max, 25mm
- 188-4133** Twist Knot Cup Brush, 12,500rpm Max, 65mm x M10
- 188-4134** Twist Knot Cup Brush, 8,500rpm Max, 100mm x M14

Flap Wheels

- Spindle mounted flap wheels with aluminium oxide abrasive
- Used with angle or bench grinders for material removal
- Ideal for deburring, cleaning, and surface finishing
- Suitable for mild, construction, alloy steel, and iron



- 189-5740** 30mm x 20mm, 60 Grit
- 189-5753** 80mm x 30mm 60 Grit
- 189-5755** 80mm x 30mm, 120 Grit

Polishing Wheel

- Pure cotton polishing wheel
- Suitable for use on steel, brass, nickel silver, copper and chromium-plated products
- Can be bench or spindle-mounted



- 488-5726** 152.4 mm (6 inches) Dia.

Bonded Abrasives

- Our signature Cutting, Grinding and Extra Thin Discs are available in a range of quality levels and sizes for use on a multitude of material applications.
- Range includes Extra Thin Cutting Discs, Cutting Discs & Grinding Discs



- 184-9242** Extra Thin Cutting Disc, 125mm x 1.0mm x 22mm, Pack of 5
- 184-9233** Metal Grinding Disc, 230 x 6.5 x 22.23mm, 6,600rpm

Rotary Tools Accessory Kit

- Multitool accessory kit
- Rotary tool
- Shaft Dia.s of 2.3 mm and 3.2 mm
- For use with Dremel tools
- Big polishing wheels (x4)
- Collets: 1.5



- 499-9134** 400 Pieces - Cotton wheel, Cutting discs (x167), Diamond points (x5), Drill bits (x4), Grinding stones (x10), Grinding wheels (x12), Mandrels (x3), Milling cutters (x2), Nylon brushes (x3), Polishing wheel shank, Reinforced cutting discs (x5), Rubber wheels (x2), Sander drum mandrels (x2), Sanding discs (x150), Sanding drums (x12), Sharpening stone, Small polishers (x6), Spanner/screwdriver, Wire brushes (x4)

Reversible Countersink Deburring Tool

- Depressing the end button automatically rotates the cutting blade to position it for either front or back deburring
- Deburring both front and back sides of holes
- Range 3 - 5.5 mm
- Steel Handle
- R1 Blade



123-0911

6 Piece Diamond Needle File Set

- Very high quality industrial standard needle files coated with diamond grit enabling them to file materials such as tungsten carbide, ceramics, carbon, glass, hardened steels etc.
- File length is 160mm
- Contents: round profile, half round profile, 3 square profile, square profile, flat/warding profile and hand profile



732-145 160mm Needle File Set

Bastard Engineers File Set

- Ergonomic grip
- Lanyard hole in handles for working at height
- Bright red foam helps identify missing parts quickly
- Foam tool modules are designed for regular easy removal from drawers
- 5x 200mm Bastard Files (Cut Hand, Half Round, Round, Square, Three Square Engineer File.)
- 6x 160mm Needle Files (Flat, Hand, Half Round, Round, Square, Three Square File Needle File.)



833-5953 11 Piece Standard and Needle File Set

Swiss Pattern Needle File Set

- Comes supplied with flat/warding (barette), knife, round, half flat, hand & square files
- Handle also supports Noga scraper blades
- Wide range of file types to ensure that your application is covered



521-908 160mm, Second Cut Needle File Set

Needle Files

- High quality precision needle files for the fine abrasion, profile cutting and finishing of many common workshop materials
- Each file has a different cross-section as shown and except for the 'hand' and 'warding' which are squared off, all taper to a fine point
- Overall length 160 mm, cutting face 28 teeth per cm (cut no. 1)
- Round file has a Dia. of 6.35 mm (0.25 in)



541-6911 Hand

THREADING TOOLS

RS PRO provides a selection of threading tools, including taps, dies, thread gauges, and thread repair kits, enabling precise and efficient creation and repair of threads in various materials.

Workshop Range Tap & Die Sets

- HSS set with bar type wrench and ratchet wrench for small tap size
- Metal storage cases with hardwood partition trays



- 300-7464 1/4-1/2 UNC
- 300-7470 1/4-3/4 UNC
- 300-7509 1/4-3/4 UNF
- 300-7442 M6-M12
- 300-7458 M6-M20

Die Nut Set

- Carbon steel die nuts to DIN standard
- Supplied in a wooden box



- 300-7537 5 Piece UNC 1/4in-1/2"
- 300-7521 5 Piece UNF 1/4in-1/2"
- 506-4318 7 Piece metric M3-M12
- 300-7515 5 Piece metric M5-M12

Tap - Die & Tapping Drill Set

- A selection of different tap & die sets for use in workshops
- Each kit combines taps, dies and drills
- Larger kits include tap wrench and thread gauges



- 506-4267 18 Piece M3-M10 HSS
- 668-1138 32 Piece M3-M12 Carbon Steel
- 668-1122 44 Piece M3-M12 HSS
- 668-1129 54 Piece M3-M20 HSS

HSS Tap & Die Sets

- Supplied in a sturdy wooden case with blow moulded cut outs for secure placement and protective foam in lid
- Ideal for the quick identification of the right or missing parts
- Secure metal clasp for security and safe transportation



427-913 M2-M6

Tap & Drill Sets

- Ideal for use with hand or power tools



- 248-5560 12 Pieces - Tap and drill set - M3, M4, M5, M6, M8 and M10
- 828-117 6 Pieces - Tap only - M3, M4, M5, M6, M8, M10
- 340-6934 Tap & Drill Set, M3 to M10 Thread

ISO Metric Tap Set

- Set of 2 taper and plug tap
- Supplied in polypropylene case
- Course thread



152-435	M16
749-5688	M3
749-5682	M4
749-5691	M5
151-858	M6
749-5694	M6

HSS Pipe Thread Tap

- PG DIN40432 thread
- Plain shank



917-2606	PG21 x 16tpi
917-2615	PG29 x 16tpi

BSPF Tap Set

- One taper tap with a 4° chamfer and one plug tap with 23° chamfer per set
- Supplied in polypropylene tubes



152-378	1/2"
152-176	1/4 Inch
152-160	3/8"

Metric Die Set

- High quality high speed steel ISO dies



668-0775 8 Piece Die Set - M3, M4, M5, M6, M8, M10, M12 dies and die-cast die holder

Metric Dies Left Hand Thread

- High quality, High Speed Steel dies
- Metric coarse thread
- Polypropylene storage case



668-0766	M12 x 1.75mm
668-0753	M4 x 0.7mm
668-0750	M6 x 1.0mm
668-0769	M8 x 1.25mm

Spiral Point Tap Set

- 7 Piece set contains M3-M12 sizes
- Manufactured from high-speed steel (HSS), ensuring excellent durability
- Suitable form hand and machine application
- Durable metal storage case



427-963 7 tap set: M3, M4, M5, M6, M8, M10, M12

Tap & Drill Sets

- Ideal for use with hand or power tools



375-9323 8 Pieces - M3, M4, M5, M6, M8, M10, M12

HSS Hand Tap & Drill Sets

- High Speed Steel taps to tolerance class of tap: 6H
- M3-M12



917-2609	14 Piece spiral set 7 taps & 7 drills
917-2602	14 Piece straight set 7 taps & 7 drills
917-2599	29 Piece set includes 2nd & bottom tap, drills and tape wrench

Metric Thread Repair Kit

- Includes HSS drills, taps, mandrels, tang break off tools, thread inserts and more, providing everything you need to repair threads for various applications
- Other thread sizes available on the RS website



HSS Rethreader

- Use with switchboxes and faceplates
- For cleaning out and cutting damaged threads



125-3090	M3.5 x 0.6
125-3091	M4.0 x 0.7

HSS Die Nuts

- Manufactured to BS1127; 1950 standard
- Ideal for use in areas where access is limited



424-213	M10 1.5mm
424-217	M12 1.75mm
424-239	M4 0.7mm
424-235	M5 0.8mm
424-229	M6 1.0mm
424-223	M8 1.25mm

ISO Metric (Coarse) Tap Set

- A range of sets with tools ideal for cutting thread into material such as metal bolts
- Ideal for use with a tap wrench or drill
- Set of 3 contains taper, second and plug tap
- Supplied in polypropylene case



215-546	M10 x 1.5
215-524	M12 x 1.75
215-552	M3 x 0.5
215-580	M4 x 0.7
215-574	M5 x 0.8
215-530	M6 x 1.0
215-568	M8 x 1.25

ISO Metric Fine Straight Flute Taps

- High Speed Steel construction
- Second tap lead angle approximately 8°



522-7575	M10 x 1.0
522-7581	M10 x 1.25
522-7597	M12 x 1.25
522-7604	M12 x 1.5
522-7610	M14 x 1.5
522-7632	M18 x 1.0
522-7654	M20 x 1.5
522-7660	M25 x 1.5
522-7676	M30 x 1.5
522-7569	M8 x 1.0

HSS Metric Taps Left Hand Thread

- High quality High Speed Steel taps
- Metric coarse series thread
- Straight flute
- Set of 3 taper, second and plug tap
- Supplied in a polypropylene storage case



668-1084	M12
668-1071	M4
668-1078	M6
668-1087	M8

917-2523	M10
917-2520	M12
917-2501	M16
917-2517	M2.5
917-2494	M2.5-M6 5 Piece
917-2498	M3
917-2508	M4
917-2482	M4-M10 5 Piece
917-2514	M5
917-2491	M5-M12 5 Piece
917-2505	M6
917-2511	M8

Die Stock

- Chemically blackened finish
- Chromed handles



444-885	1 5/16 inch
444-895	1 inch
359-6677	13/16 inch
300-7363	25mm

HSS M2 Grade Dies

- Precision engineered, split form dies made to BS1127:1924 for machine or manual operation



215-710	M10 x 1.0mm
215-726	M10 x 1.25mm
215-619	M10 x 1.5mm
215-732	M12 x 1.0mm
215-748	M12 x 1.25mm
215-754	M12 x 1.5mm
215-625	M12 x 1.75mm
215-669	M2.5 x 0.45mm
215-653	M2 x 0.4mm
215-647	M5 x 0.8mm
215-596	M6 x 1.0mm
215-811	M8 x 1.0mm
215-603	M8 x 1.25mm

CABLES, CONNECTORS & CRIMPING TOOLS

RS PRO provides a wide range of cables, wires, connectors, and crimping tools, including Ethernet cables, electrical connectors, crimping pliers, and termination kits, offering reliable and efficient solutions for electrical and data connectivity needs.

2 Piece Electricians Tool Kit With Foam Inlay

- Various ranges of quality assured tool sets for addition to tool cabinets



833-5966 2 Piece Climper and Stripper Set

Hand Ratcheting Crimp Tool

- Ergonomic non-slip main handle and low friction moving handle ensure a comfortable hand grip
- Provides two-hand grip in the final phase of crimping, increasing comfort and productivity
- Full cycle crimp mechanism to ensure consistent, reliable crimp



683-1623 Crimp Tool for BNC, TNC, N, Ethernet and Thinnet Connectors

Automatic Wire Stripper

- Precision carbon steel laminated stripping blades
- Compact pistol-grip design for increased control and a smooth stripping action
- Adjustable sliding wire stop to preset exact stripping lengths
- Shielded cutter for safety



382-2847 0.08 to 2.5mm stripping range
384-7385 6 to 16mm stripping range

Network Tool Kit

- The LAN network cable tester consists of a main unit and remote unit and is ideal for testing RJ45 and RJ11 cables and modular plugs. The tester and remote both feature clear and user friendly interfaces, with LED lights to indicate power. The network tester allows you to quickly and efficiently check for cable continuity, miswiring as well as open, short, straight-through or cross pinning.



194-5912 Punch down Tool, Modular Crimping Tool, Universal Cable Stripper & Cutter, LAN Cable Tester

Electronics Tool Kit With Foam Inlay

- Phosphated driver tips for corrosion protection, increased strength and longer tool life
- Bright red foam compartments help small parts and fixings stand out
- Tool storage - foam tool modules are designed for regular easy removal from drawers



833-5919 10 Piece Precision Plier and Screwdriver Set

Brass Terminal Blocks

- Brass terminal blocks complete with galvanised screws.
- Screw Down



867-0991 3 Way
867-1004 5 Way
867-1007 8 Way

Commoning Terminal Blocks

- Compact design allows high-density connections
- Housing material: transparent blue polycarbonate
- Self-extinguishing: UL 94 - V0; IEC 692-1 to 850°C; IEC 692-2
- Maximum operating temperature: 85°C
- Clamps: Brass, Captive screws: galvanized steel
- Protection degree: IP 20

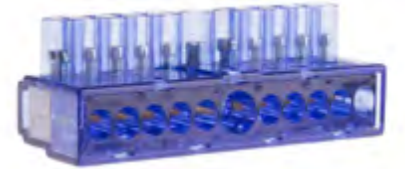

868-0752 11 poles, 6-16
868-0806 3 poles 35
868-0774 5 poles + prot
868-0799 6 poles 16-35
868-0792 6 poles 6-16

M20 IP68 Cable Glands

- Made from nylon 66, completely sealed against dust and offering excellent water resistance
- Extensive range available on the RS website
- Bag of 5



669-4660 4-9mm cable Dia.
669-4664 6-12mm cable Dia.
669-4673 10-14mm cable Dia.

3 Way Fused Terminal Block

- Features an integrated in-line fuse holder.
- The white housing is made from nylon with tinned brass inserts for a screwed termination.
- A pull-up latch enables an easy replacement of a fuse.
- Inline fuse holder with pull-up latch; Tinned Brass inserts; Screw down termination



209-7561 16A 1.25IN

Steatite Terminal Blocks

- Nickel-plated brass inserts and plated steel screws
- Suitable for use in high ambient temperatures up to 300°C
- High dielectric strength
- Non-flammable with dimensional stability up to 1000 °C
- Pack of 5



703-3858 2 Ways 10mm²
703-3846 2 Ways 4mm²
703-3814 2.5mm²
703-3852 3 Ways 10mm²

Solder Tag, Brass Contacts, Tin Plated

- Brass solder tag
- Tin plated
- High level of solderability
- Easily manipulated



186-7876 M2/8BA
186-7854 M3.5/4BA
186-7860 M3/6BA
186-7848 M4/3BA
186-7832 M5/2BA

Polyamide Barrier Strips

- Black, polyamide housing
- M3.5, steel nickel plated screws
- 0.8Nm maximum torque
- -40 to +105°C



763-8110 2 Way
763-8129 3 Way
763-8122 12 Way

HDMI to HDMI Cable

- Black, PVC outer sheath
- Stand size of 30 AWG (American wire gauge)



- 182-8514** Male to Female, 0.5 m, 4K
- 182-8515** Male to Female, 2 m, 4K
- 182-8473** Male to Male, 2 m
- 182-8474** Male to Male, 3 m, 4K
- 182-8475** Male to Male, 5 m, 4K

HDMI to DVI-D Dual Link Cable

- Two-way DVI-D to HDMI cable
- Durable gold-plated covering guarantees a solid connection
- Black PVC sheath combines flexibility with durability
- Dual-link cable supports 4k maximum resolution



- 182-8878** Male to Male, 1 m, 4K
- 182-8879** Male to Male, 2 m
- 182-8569** Male to Male, 3 m, 1920 x 1200
- 182-8570** Male to Male, 5 m, 1920 x 1200

HDLock Locking Connector HDMI Cable

- 2.0 V with Ethernet and Audio return channel
- 24k gold plated copper contacts for corrosion resistance
- 2 Latch Locking connector – prevents the plug from coming loose or undone



- 852-5279** 1 m
- 852-5273** 3 m
- 852-5282** 5 m
- 852-5285** 10 m

HDMI to Micro HDMI Cable

- Outer Dia. of 5.5 mm
- Wire size of 30 AWG
- Conforms to ANSI/ESD S20.20:2014 and BS EN 61340-5-1:2007 Electrostatic Control Standards



- 182-8896** Male to Male, 1.5 m, 4K

DisplayPort to HDMI Adapter

- The adapter has a durable ABS shell and a PVC (Polyvinyl Chloride) outer jacket for extra durability and protection
- A 34 AWG cable flex connects the DisplayPort housing to a PCB inside the HDMI housing
- These adapters can offer optimum signal quality with minimal interference, ensuring optimum performance



- 195-4279** Male to Female, 15cm

Jack Cable Assembly

- Ideal addition to any professional set up for audio, visual or lighting connector applications
- PVC outer sheath allows for extra durability and flexibility



- 192-4393** Male to Male, 2m
- 192-4419** Male to Female, 2m

DisplayPort to DisplayPort Cable

- Capable of supporting three-dimensional (3D) video and high resolutions, making it a versatile option for different graphics cards.
- Maximum resolution of 8K
- Compatible with DP 1.3 and 1.2 so you won't have a problem using it with older model devices



- 195-4906** Male to Male, 0.5m, 8K
- 195-4909** Male to Male, 2 m, 8K

VGA to VGA cable

- Low profile VGA connectors
- Secure connection
- Ideal for use in high visible areas or racks with limited space
- Can be used for video signal connection of PC/Laptops, projectors, display screens



- 182-8539** Male to Female, 3m
- 182-8525** Male to Male, 5m
- 182-8541** Male-to-Female, 5 m

HDMI to VGA Cable

- Active convertor which uses a chipset to convert the digital HDMI signal on your Laptop/Desktop etc to an analogue SVGA signal on your display.
- SVGA shell is made of black ABS and the cable and HDMI hood is made from black PVC.
- HDMI connector has gold plated connections, while the SVGA connector has nickel connections.



- 192-4515** Male to Male, 1 m, Gold Plated

Display Port to HDMI Adaptor

- Passive adapter block with DVI-D output
- Supports bandwidth up to 10.8Gbps
- Includes 1Mbps bidirectional auxiliary channel
- Black ABS thermoplastic case
- Compliant with VESA interface standards



- 182-8790** Display Port Male to HDMI Female

DisplayPort to HDMI Cable

- Black PVC casing for effective insulation
- 24-bit colour depths
- Internal wire gauge of 30 AWG



- 186-3034** Male to Male, 1 m, 4K
- 186-3035** Male to Male, 2 m, 1080p

Video DVI Interface Cable

- A selection of cable assembly allowing interface to analogue monitor/graphics cards and digital displays.



- 489-355** DVI-A to VGA Cable Adapter

DisplayPort to DVI-D Cable

- Black PVC casing for effective insulation
- Internal wire size of 30 AWG
- Offers a maximum resolution of 1080p
- Enables 8-bit and 10-bit deep colour
- Supports the 1Mbps bidirectional auxiliary channel



- 182-8788** Male to Male, 5m, 1080p

Mini DisplayPort to DisplayPort Adapter

- Connect a DisplayPort monitor to a computer or graphics card that has a Mini DisplayPort output.
- Operates in one direction and would be plugged in to the computer or graphics not the monitor, allowing you to use an existing DisplayPort Cable.



- 192-4523** MINI DP Male TO DP Female

DVI-D to DVI-D Cable

- PVC outer sheath material
- Black sheath colour
- Strand size of 30 American Wire Gauge (AWG)



- 186-3027** Male to Male, 10 m

D25 Way to D25 Way

- Thumb screws for secure connection
- 25-way RS232 serial connector with pin assignment
- Grey PVC cable flex with strain relief
- Gold flash pins, aluminium-mylar foil shielding
- Suitable for PC to DCE connection



- 182-8823** Male 25 Pin D-sub to Female 25 Pin, 2m PVC
- 182-8906** Male 25 Pin D-sub to Female 25 Pin, 6m PVC

D-Sub Adaptor

- Converts from 9-way D-sub type to 25-way D-sub type
- Operating voltage of 300 V



- 210-1004** Female 9 Way D-Sub to Male 25 Way D-Sub
- 218-251** Male 9 Way D-Sub to Male 25 Way D-Sub

USB A to USB A

- Ideal addition to extend short USB cables in a wide range of applications



182-8842	USB 3.0, Blue, Male USB A to Male USB A, 1m
182-8844	USB 3.0, Blue, Male USB A to Male USB A, 3m
182-8913	USB 3.0, Male USB A to Female USB A USB, 1.8m
182-8912	USB 3.0, Male USB A to Female USB A USB, 1m
186-3051	USB 3.0, Male USB A to Female USB A USB, 2m
182-8840	USB 3.0, Male USB A to Female USB A USB, 3m
182-8841	USB 3.0, Male USB A to Female USB A USB, 5m
182-8914	USB 3.0, Male USB A to Male USB A, 800mm
182-8828	USB 2.0, Grey, Male USB A to Male USB A, 2m
186-3013	USB 2.0, Male USB A to Female USB A USB, 1.8m
195-4275	USB 2.0, Male USB A to Female USB A USB, 2m
186-3014	USB 2.0, Male USB A to Female USB A USB, 3m
186-3012	USB 2.0, Male USB A to Female USB A, 500mm
186-3011	USB 2.0, Male USB A to Male USB A, 500mm
182-8855	USB 2.0, White, Male USB A to Male USB A, 800mm
182-8830	USB 2.0, Male USB A to Female USB A, 1m
182-8488	USB 2.0, Male USB A to Female USB A, 1m
182-8486	USB 2.0, Male USB A to Female USB A, 250mm
182-8489	USB 2.0, Male USB A to Female USB A, 5m
182-8482	USB 2.0, Male USB A to Male USB A, 1m

USB A to USB B

- Ideal addition to extend short USB cables in a wide range of applications



182-8551	USB 2.0, Black, Male USB A to Male Micro USB B, 500mm
182-8496	USB 2.0, Male USB A to Male Micro USB B, 1.8m
182-8495	USB 2.0, Male USB A to Male Micro USB B, 1m
182-8871	USB 2.0, Male USB A to Male Micro USB B, 1m
182-8497	USB 2.0, Male USB A to Male Micro USB B, 3m
182-8498	USB 2.0, Male USB A to Male Micro USB B, 5m
182-8491	USB 2.0, Male USB A to Male Mini USB B, 1m
182-8493	USB 2.0, Male USB A to Male Mini USB B, 3m
182-8490	USB 2.0, Male USB A to Male Mini USB B, 500mm
182-8494	USB 2.0, Male USB A to Male Mini USB B, 5m
182-8547	USB 2.0, Male USB A to Male USB B, 0.5m
182-8549	USB 2.0, Male USB A to Male USB B, 1.8m
182-8831	USB 2.0, Male USB A to Male USB B, 1m
182-8866	USB 2.0, Male USB A to Male USB B, 2m
182-8832	USB 2.0, Male USB A to Male USB B, 2m
182-8838	USB 2.0, Male USB A to Male USB B, 3m
182-8833	USB 2.0, Male USB A to Male USB B, 3m
182-8867	USB 2.0, Male USB A to Male USB B, 3m
182-8550	USB 2.0, Male USB A to Male USB B, 3m
182-8870	USB 2.0, White, Male USB A to Male Micro USB B, 150mm
182-8864	USB 2.0, White, Male USB A to Male USB B, 800mm

USB A to USB C

- Ideal addition to extend short USB cables in a wide range of applications



186-3055	USB 2.0, Male USB A to Male USB C, 2m
186-3053	USB 3.0, Male USB A to Male USB C, 2m
182-8849	USB 3.1, USB 3.1, Male USB C to Female USB A, 150mm
186-3056	USB 2.0, Male USB A to Male USB C, 3m

USB C to USB C

- USB 3.1, with a maximum transfer speed of 10 Gbps
- Supports HDMI, DisplayPort and Thunderbolt 3 interfaces
- Backwards compatible with USB 2.0 and 3.0



182-8846	USB 3.1, Male USB C to Male USB C, 1m
----------	---------------------------------------

USB C to Micro USB

- Ideal addition for greater flexibility when connecting older USB 2.0 devices with a Type B micro socket to modern computers that only have a USB Type C socket in a wide range of applications
- The 22-24 AWG power wires (dependant on cable length - 1 m, 2m or 3 m) makes this cable ideal for fast charging phones and cameras, etc



192-4734	USB 2.0, Male USB C to Male Micro USB B, 1m
----------	---

USB 2.0 Adaptors

- Designed to link USB assemblies and peripherals



186-3009	USB A Female to USB A Female
495-5336	USB A Female to USB A Female
495-5364	USB A Female to USB B Female
495-5342	USB A Female to USB B Male
514-2610	USB A Male to USB A Male
495-5358	USB A Male to USB B Female
182-8480	USB A Female to USB B Female
182-8479	USB A Female to USB B Male

USB C to HDMI Adapter

- Allows you to connect two HDMI displays to a source with a USB C port.
- This adapter allows you to connect two computer screens or TVs with 4k@60Hz to your Laptop/ computer.



236-8997

USB C to USB Micro USB Adapter

- Compact and robust
- Housing material: Polyvinyl chloride (PVC)
- Data Transfer: 480 Gbit/s
- Input Current: 3 A
- Black colour



195-4881 USB C Male - USB 2.0 Micro B Female

USB Hubs

- Provide a reliable high-speed connection
- Increase the number of ports available on your device



220-6492	USB 2.0, 4 Port
236-9129	USB 3.0, 4 Port, 15cm Cable
141-1989	4 x USB A Port Hub, USB 2.0 - USB Bus Powered

USB C Hubs

- Ideal addition for greater flexibility when connecting multiple USB compatible devices into one central dock across a wide range of applications
- Reliable high-speed connection with Plug and Play and hot-swap functionality, meaning no installation time and no additional software required



192-4693	USB C Male, 3 Port Hub, 15cm
192-4707	4 x USB A sockets, 15cm cable
192-4708	4 USB A socket and USB C power delivery socket, 150 mm cable

USB C to DVI-D Adapter Cable

- 1 Supported Display
- Connects DVI monitor to USB Type C device
- Supports DisplayPort Alt mode
- USB Type A socket for peripheral connection
- USB Type C socket for Power Delivery



192-4692 15cm

Micro USB B to Bare Wire USB Cable

- Connector B is a bare wire type
- Black sheath colour
- Conforms to UL 2464 standards for safety



173-3531	Male Micro USB B to Unterminated, 1.8m
173-3530	Male Micro USB B to Unterminated, 500mm

Network Adapters

- Black ABS shell and the 10cm cable flex is made from black PVC and the connectors are also moulded from black PVC.



195-4912	USB 3.0 Gigabit Ethernet Adapter, 10/100/1000 Mbps, Black
195-4911	USB 2.0 Ethernet Adapter, 10/100 Mbps, Black
144-7998	USB 2.0 Ethernet Adapter

Nylon Non-Releasable Cable Ties

- Supplied as a bag of 100
- Popular sizes shown, many more sizes available on the RS website



233-455	100 x 2.5mm
233-465	150 x 3.6mm
233-487	300 x 4.8mm

Cable Tie Gun

- Metal construction
- Adjustable tension
- Tension indicator
- Suitable for tensioning and cut for cable ties



206-1753 2.4 > 4.8mm Capacity

Brush Plate

- Option for single or double gang
- Fits onto back box or can be screwed directly to the wall
- Ideal for passing cables through a wall
- Tidy and professional finish for roughly cut holes



878-1091	1 Way
878-1101	2 Way

Blue Metal-Detectable Cable Ties

- Industry-standard blue colour for easy visual identification
- Metal powder particles offer full magnetic and x-ray detection, even if parts have been trimmed to fit



172-1766 Blue, 150 x 3.6mm, 100 Pack

Spiral Wrapping Installation Tools

- Assists with the installation of spiral or split wraps used in cable bundles or on electrical harnesses
- Made from polypropylene (PP)
- Available in multiple sizes applicable to the cable wrap



204-4436	For 25mm Dia. Bands
204-4435	For 20mm Dia. Bands
204-4438	For 8mm Dia. Bands
204-4433	For 15mm Dia. Bands

Spiral Wrap

- Essentials to keep your cables safe from damage and ensure your installation is neat and tidy
- Made from strong polypropylene, halogen-free and completely reusable



204-4431	15mm Dia., Black, 2m length
204-4418	15mm Dia., Black, 25m length
204-4420	20mm Dia., Black, 25m length
204-4421	25mm Dia., Black, 2m length
204-4422	25mm Dia., Black, 25m length

Split Flexible Conduit

- For cable protection in electrical installations, machinery and buildings
- Special design allows bends around corners without kinking
- The split allows the conduit to be installed easily onto pre-installed wiring



755-9026 Black, 25mm

Flexible Self-Adhesive Slotted trunking

- Polypropylene halogen free flexible
- Provided with strong self adhesive backing
- Round shape, low flammability and self extinguishing in accordance with UL94-V1
- Operating temperature range of -20°C to +70°C



598-591 500x11x9mm

Heavy Duty Cable Protectors

- Weather and skid proof
- Black base & yellow cover provide good visibility
- High strength cable grooves, can withstand up to 20 tons per axle



136-5423 1000 x 250mm

Pipe Clips

- A range of P-clips for secure clamping of pipes, conduits and cables.
- Available in bright zinc plated steel or A2 grade 18 / 8 stainless steel
- Supplied with TPE or PVC liners to prevent chafing of pipe, cable, etc.
- Temperature range -30°C to 60°C
- Available in BZP Steel and Nylon



186-5353	BZP Steel, 10mm
186-5375	BZP Steel, 12mm
186-5381	BZP Steel, 16mm
186-5397	BZP Steel, 20mm
186-5404	BZP Steel, 25mm
186-5410	BZP Steel, 32mm

Nickel Plated Brass Locknuts

- A selection of 1.5 mm pitch nickel plated brass locknuts
- Metric threads to EN60423
- Complies with EU Directive 2002/95/EC-ROHS
- Complies with EU Directive 2002/96/EU Waste Electrical Equipment-WEEE



127-473 M20, 3.5mm

Open Slot Grey PVC Cable Trunking

- Self-extinguishing to UL94-V2
- Warp-proof PVC with a slot gap of 8mm
- Available in 1 or 2m lengths
- Open or Narrow slot
- Sold in a pack of 4



301-1924	Open 25x25mm, 2m
879-3725	Open 8mm 40Wx40H, 1m

TEST & MEASUREMENT TOOLS

RS PRO provides test and measurement equipment such as multimeters, oscilloscopes, calipers, and thermometers for accurate measurements.

Digital Vernier Caliper

- A digital vernier caliper with stainless steel rule & jaws, and offering 4 way measurement
- Measurement range of 0mm and 150mm or 0mm and 200mm with a resolution of 0.0005in, 0.01mm



243-6616	150 mm/6", Metric
243-6615	150 mm/6", Imperial/Metric
243-6617	200 mm/8", Imperial/Metric

Plastigauges

- Can highlight clearance, lobing, ovality on shafts
- Volumetric measurement takes surface roughness into account
- Clearance measurement 0.001in. to 0.020in. (0.025 to 0.5mm) can be taken.
- Non corrosive and oil soluble



222-4444	0.001-0.007in / 0.025-0.175mm
222-4472	0.008-0.020in / 0.2-0.5mm

Tape Measure

- Self-locking mechanism allows blade to be extended smoothly
- Push button allows blade to be retracted smoothly
- Nylon coated blade for maximum durability
- Impact resistant rubberized case



254-6240	3m
254-6241	5m
254-6242	8m

Measuring And Cutting Tool Kit with Foam Inlay

- General-purpose compact workshop measuring and cutting toolset
- Contains precision measuring tools and heavy-duty cutting tools
- The bright red foam helps identify missing parts quickly
- Foam tool modules are designed for regular easy removal from drawers



833-5944	6 Pcs - Electricians scissors, Straight snip, Snap-off utility knife, Measuring tape, Stainless steel ruler, Leaf metric feeler gauge
----------	---

Laser Distance Measure

- Designed for quick, non-contact measurement of areas and volumes of rooms, heights, distances and angles
- Light & pocket-sized digital measure for easy transport
- Records up to 20 points, with laser pointer targets
- LCD status indicator and distance calculator functionality



126-8821	0.05 □ 50m Range, ± 1.5 mm Accuracy
----------	-------------------------------------

Fine Adjustment Vernier Caliper

- Vernier Caliper with hardened Stainless Steel frame and jaws for extremely accurate outside, inside, step and depth measurements.
- Dual scale with both metric and imperial readings
- Manufactured from hardened steel
- Fine adjustment mechanism with lockscrews



841-2533	300mm/ 12in, Imperial/Metric
----------	------------------------------

Level Dial Indicator

- When turned off indicator will remember the last reading and display upon start up
- M2.5 Dia. ball anvil measuring contact
- Lug back mounting fitted as standard
- 1x SR44 Coin Cell battery



841-2565	
----------	--

High Impact Spirit Level

- Sturdy design with strong non-magnetic base
- Electrostatic powder coating
- Frame constructed from aluminium
- 2 Vials - horizontal and vertical
- Accuracy ±0.5 mm/m



851-3541	250mm
----------	-------

Multifunctional Laser Level

- Single button control & professional accuracy
- Green beam laser projects from multiple angles
- Rotatable 360-degree with magnetic 'L' mount
- Soft-grip, light weight design & easy carrying - supplied with a nylon bag



230-7854	Self-levelling laser
----------	----------------------

Pocket Level

- 0.5 mm/m (0.029°) accuracy
- Ultrasonic welded block vials
- Rigid aluminium box section
- Shockproof end caps
- Built-in magnets



194-4705	120mm
----------	-------

External Digital Micrometer

- Imperial or metric reading
- Resolution 0.001mm (0.00005in.)
- Resettable origin point
- Automatic power-off
- Lockable spindle



705-1229	0-25mm
----------	--------

External Metric Micrometer Set

- Measurement range: 0 mm to 150 mm
- Resolution: 0.01 mm
- Accuracy: ±0.004 mm
- Set includes six micrometers, setting rods, and adjustment tools



705-1213	Range 0 mm >150 mm
----------	--------------------

Compact Multimeters

- Manual ranging, 2000 count DMM that measures capacitance, voltage, current, resistance and temperature



123-1939 RS12 Manual Ranging

Compact Multimeters

- 2000 Counts LCD backlit display
- Voltage 600V ac/dc
- Current 10Aac/dc
- Resistance
- Temperature measurement (RS14)
- Continuity
- EN61010-1 CAT III 600 V



123-1938 RS14 Autoranging

Handheld Digital Multimeter

- Digital multimeter
- Compact and handheld
- Measures AC/DC Voltage, AC/DC current, Resistance, Diode test, Continuity, Capacitance Frequency and Temperature
- Non-Contact AC Voltage detector
- Long service life
- Battery type: 2 x AAA 1.5V



264-7228 RS-927A, True RMS, 10A ac Max, 10A dc Max, 600V ac Max

Insulation & Continuity Testers

- Triple insulation voltage Test Ranges: 250V; 500V; 1000V (RS5505 adds 125V range)
- 200mA short current continuity range
- Test Hold function for easy operation
- Over range indication
- 1 mA test current for MΩ range at rated voltage
- Meets IEC 10101, CAT III 1000 V



123-1931 2GΩ CAT III 1000 V

Clamp Meter

- 400A AC auto-ranging clamp meter with AC and DC voltage, resistance, continuity functions
- Uses non-contact detection with Overvoltage Category III 600 V protection
- Supplied with test leads, carrying case, temperature probe, AAA 1.5 V batteries x2 and user manual



123-1935 RS380, 400A ac CAT III 600 V

True RMS AC/DC Clamp Meter with Dual Type K Inputs

- Large, easy-to-read backlit LCD display for greater functionality, the clamp meter is also ideal for use in low light environments
- Comes with a 9 V battery, test leads and a temperature probe



200-3702

Compact Digital Multimeter

- Compact design makes this multimeter ideal for working on the go
- Clear and precise 2000 count LCD display screen
- Safety category CAT III, CAT IV, 600 V, 1000 V
- Ideal for measurement of AC Current, AC Voltage, Continuity, DC Current, DC Voltage, Diode, Resistance
- Test leads included



161-1625

3 in 1 Wall Scanner

- Detects metal or wooden studs from 0-38mm through drywall
- Live AC wires can be detected from 0-50mm through drywall
- Handheld and powered by a 9V battery
- Supplied with a 9V battery and gift box



193-8684 Stud, Metal and AC Voltage Finder

Magnetic Field Indicator / Solenoid Testers

- Powerful red light in the tip to indicate the presence of a magnetic field.
- Easy to use.
- Solenoid valves in pneumatic and hydraulic control equipment can easily be tested.



375-5422 0.3mT, 1000V ac

141-1996 ATEX, 0.3mT

Earth & Ground Resistance Tester

- Meets IEC10101, CATIII 1000V
- Large dual display with back light & Low Battery Indication
- Test hold function for easy operation
- Zero Automatic adjustment
- Sampling Rate: 2.5 times per second
- Includes x 6 "AA" batteries, test leads and carrying case



144-5339 ET5300, 2kΩ

Resistance Decade Box

- Decade box for electrical resistance measurement
- Heavy-duty construction for durability in harsh environments
- 7-decade ranges from 1 to 111Ω in 1Ω increments
- Separate grounding terminal, isolated substitutions
- Powered by 0.3W resistors, versatile for various applications



193-8686 R-100

Voltage Tester

- LED display indicator for visual notification
- Audible buzzer for enhanced notification
- Wide operating temperature range
- IP67 rating for protection from dust and liquid



161-1627 LED Display, Buzzer Indicator & Torch

Probe Sets

- 0.7mm (0.028") O.D. Back Probe Pins
- Ideal for fuel injectors, sensors, weather pack connectors
- Compatible with industry-standard 4mm plugs
- Perfect complement to test leads
- Cable piercer option minimizes cable damage



124-7405 Ultra Thin Back Probes, Black/Red

124-7402 Ultra Thin Back Probes with Cable Piercer, Black/Red

Multimeter Test Lead

- Crocodile clip jaws will open to 5.5 mm at the tips
- Pack of 10: 2 x red, 2 x black, 2 x Green, 2 x yellow and 2 x white



161-6511 0.5m, Pack of 10

Tachometers

- Designed with a durable and robust housing for use in challenging environments while offering an intuitive and easy to use interface for optimum ease of use
- The handheld device offers a wide measuring range and high resolution for accurate and reliable results
- Supplied with a 9V battery and convenient carry case for easy storage and device protection when not in use
- 60 x 42 x 160mm



193-8688 AT-8, Contact/Non-Contact Tachometer

193-8687 AT-6, Non Contact

Digital Thermometer and Hygrometer

- Indoor/Outdoor
- LCD Display



196-8736 TA298, Indoor/Outdoor

Thermo-Anemometer

- High-quality and robust design that offers accurate and reliable results and can be used across a variety of applications



193-8696 RS-3893, Air Flow, Air Velocity, Temperature

Digital Thermohygrometer

- Large LCD display and clear measurement parameters, allowing for easy reading of measurements
- Temperature from -10°C to +60°C and a hygrometer range 0 to 99% RH



195-9129 108mm x 103mm x 25mm

Microwave Leakage Detector

- An ergonomic and intuitive user design with a large, easy to read LCD display
- High microwave sensitivity and can detect even low levels of radiation with confidence and accuracy, ensuring reliable measurement results
- Audible and visual alarm triggers above the safe level of 5.0 mW/cm2 radiation leakage



193-8685 RS-2G, 0-9.99 mW/cm2

Analogue Thermohygrometer

- Large 150mm face and white ABS case, allowing for easy reading of measurements
- Dual-purpose Thermometer and Hygrometer which measures temperature and humidity, suitable for use in a variety of applications
- Temperature from -20°C to +40°C and a hygrometer range 20 to 80% RH



165-1486

Handheld Digital Thermometer

- Offering clear user friendly digital display, it features 3 1/2 digit liquid crystal (LCD) with a maximum reading of 1999.
- Ambient high operating range of -50 to 1300°C.
- Backlit easy-to-read display



123-1937 RS42

Handheld Digital Thermometer

- A range of thermometers offering a choice of number of inputs, thermocouple type and with or without datalogging
- K or J-Type - thermocouple input depending on model
- Real-time stamp (RS53 / RS55)
- Data logging up to 16000 records (RS53 / RS55)
- °C, °F or °K display



123-3215 RS51 Type-K One Input

Temperature and Humidity Datalogger

- High-accuracy data logger with 32,700 value memory
- Large LCD screen for easy information display
- Freely selectable measurement cycle with USB interface for data download
- Alarm display for user-defined value exceedance
- Analysis software for data graph viewing
- Long-lasting lithium-ion battery with 3-year life



146-9091 RS-172

Infrared Thermometer

- IR non-contact mode
- Pocket sized pistol grip
- Built-in laser sighting
- Backlit LCD display
- 123-2217 also accepts a plug-in type-K thermocouple probe (-150°C to +1350°C)



123-2216 -20°C to +500°C

123-2217 -150°C to +1350°C

NTC Temperature Probes

- Used for temperature measurement with thermostats
- Temperature ranging from -30°C up to +80°C
- Accuracy of ±0.5% and long-term stability
- 1.5 m cable for all models



124-1081 Air probe, stainless steel shell, silicon cable

124-1082 Liquid probe, stainless steel shell, silicone cable

USB Dataloggers

- Stores over 16,000 readings (Vdc version is 32,000)
- Temperature (and Humidity) units are IP67
- User settable logging rates and alarms
- Includes software



179-9536 Temperature & Humidity -35 to +80°C

179-9535 Temperature -35 to +80°C

179-9537 Voltage 0 - 30Vdc (screw terminals)

192-4382 0.3mm - 1350µm, LCD Display

IP67 RATED

Dial Thermometer

- Designed to indicate the surface temperature of ferrous surfaces (magnetic) and pipes (clip on)
- Ideal for fixing to radiators and not insulated pipes
- Glass Window



431-5637 Magnetic, 66mm

Type K Thermocouple Probes

- A range of K-type thermocouples for use with digital temperature indicators
- Choice of surface, immersion and air probes
- With a selection of wide temperature ranges
- Fully waterproof handles
- Type T also available, visit our website for more details



342-8962 6mm Dia. Tip surface probe -50°C to +600°C

Digital Pocket Thermometer

- Temperature Range: -50°C to +200°C (-58°F to +392°F)
- Accuracy: ± 2°C (± 4°F)



136-5671 RS40

Stackable Test Leads

- PVC insulated test lead with a stackable 4mm banana plug at each end
- Offers additional versatility
- Rating 2.5A, 50Vac
- Insulation Material UL94V-0 PVC



- 668-4572** 0.5m Black
- 668-4584** 1m Black
- 668-4588** 1m Red

Test Lead Sets

- A range of lead sets for multimeters, loop testers and other electrical test equipment
- Options include fused or unfused, plus a range of probes, grabbers, croc clips



- 125-3731** Test Leads Kit, Right Angle Plug, 1.25m, CAT III 1000V
- 161-1530** Replacement Fuses, 500mA, 1000V, 50kA
- 125-3736** Set to CATIV 600V, CATIII 1000V

30A Insulated Terminals

- Large insulated terminals ideal for high current (30A max.) power supplies and chargers
- Moulded with phenolic resin, metal parts nickel-plated brass
- Thread size: 0 BA
- Temperature range:-25°C to +85°C
- Max Voltage 3000V



- 444-781** Black
- 444-775** Red

Miniature Insulated Crocodile Clips

- PE Insulated material - provides full insulation with good plug compatibility
- Nickel-Plated Steel - offers good resistance to corrosion and is widely used in industrial crocodile clips
- Choice of colours - red and black clips are available



- 483-859** Black
- 483-843** Red

Crocodile Clips

- A range of lead sets for multimeters, loop testers and other electrical test equipment
- Options include fused or unfused, plus a range of probes, grabbers, croc clips



- 125-3740** Crocodile Clips CATIII 1000V

Non-Insulated Terminals

- Made from nickel-plated brass
- Used to terminate a single wire in test and measurement applications
- Thread Size 2BA
- For Uninsulated and Wired Terminals



- 668-4590** 30A, Pack of 5

Spring Terminals

- Spring terminals
- M4 Thread Fitting
- Rated 48V
- 15A max



- 187-3803** M4, Rated 48V, 15A max Black/Red

Gold Plated Terminals

- Gold Plated offering excellent connectivity
- Current Rating: 30A
- Flammability: Min UL94HB
- Ideal for higher current applications
- Quick and easy to install



- 187-3804** 30A

Terminal Posts - Small

- Accepts 4mm unshrouded plugs in the top or in the cross hole at the side
- Castellated tops to give additional torque when wires are clamped
- 30A rating
- Supplied in a pack of 5



- 677-8740** Black
- 677-8746** Red

Polypropylene Moulded Graduation Jugs

- High clarity tapered jugs
- Autoclavable at 121°C
- Ergonomically designed handle with thumb grip



- 478-1630** 1000ml
- 478-1618** 250ml
- 478-1624** 500ml

LDPE Wash Bottle

- Lightweight yet durable LDPE design
- Flexible yet sturdy, allowing you to squeeze with ease
- Good acid and chemical resistance



- 201-2453** Wide Mouth, Yellow Lid, 500ml

LDPE Wash Bottles With Narrow Neck

- Square shoulder round wash bottles with white tops
- PP leak-proof swivel dispensing closures
- Closures feature precision jet-tip aperture for fine control



- 461-0651** 250ml, Box of 5
- 461-0667** 500ml, Box of 5

LDPE Wash Bottles With Wide Neck

- Featuring DripLok® vapour venting valve that prevents solvent drips
- Indelibly printed in English, French, German, Spanish
- Solvent labels include Globally Harmonised Symbols, NFPA diamond, risk phrases and safety information
- Fitted with colour-coded one-piece polypropylene closures featuring precision jet-tip aperture for fine control
- Supplied in pack of 5



- 838-6377** 250ml, Isopropanol, Blue closure
- 838-6380** 500ml, Acetone, Red closure
- 838-6396** 500ml, Isopropanol, Blue closure

Pipettes

- Squeezable pipettes made of recyclable polyethylene
- Safe for liquids and foods, ergonomic design
- Clear ml measurement markings for accuracy
- Cost-effective alternative to glass or electronic pipettes, no calibration needed



- 179-3681** 3ml, 138mm
- 179-3651** 5ml, 150mm
- 179-3667** 5ml, 155mm
- 179-3663** 7ml, 160mm, 3ml Graduated

Polypropylene Cylinders

- Enhanced pin-sharp blue-printed graduations
- Stable hexagonal bases with non-slip anti-suction feature
- Safe and robust plastic construction
- S.P.I. recycling codes and batch code on each cylinder



- 461-0904** 1000ml
- 461-0875** 250ml (each)

Plastic Industrial Funnel

- Made of durable HDPE (High-Density Polyethylene)
- High flow rate fluid
- High overflow rim function as a splash guard
- Oil, acid and fuel-resistant



672-481 1.2 L

PP Funnel

- Made of polypropylene
- Small handle on top rim
- Unbreakable in regular use



263-2637 Five funnels – 60 mm, 80 mm, 100 mm, 125 mm, 140 mm

Plastic Industrial Funnel

- Made of durable HDPE (High-Density Polyethylene)
- High flow rate fluid
- High overflow rim function as a splash guard
- Oil, acid and fuel-resistant



672-453 3.2 L
263-2586 5 L

Handheld Magnifier

- 70mm magnifying lens with 5 x magnifying abilities
- Antistatic and scratch resistant properties
- Ergonomically designed handle for enhanced comfort and grip



528-5335 5 x Magnification, 70mm Dia.

Pocket Magnifying Glass

- 2 lenses offering 3, 4.5, 6 and 9 x magnification
- Slide out design for convenience
- Lenses can be pushed back into the enclosure offering protection when not in use
- Compact and lightweight design
- Easy to use
- Ideal for use with a range of applications



528-5307 4 Lenses

Handheld Magnifier

- Clear and precise magnification with minimal distortion
- Lightweight and compact design
- Housed in a polished chrome plated case offering excellent protection
- Supplied with a high quality leather pouch for enhanced protection and storage



342-9375 Single lens, 10 x magnification, 21mm Dia.

Illuminated LED Headband Magnifier and Lenses

- Acrylic lenses
- Offers 4 choices of magnification
- Fixed, flip-up or monocle lenses
- Can use when wearing glasses
- LED illumination with the option to tilt or swivel
- Visor can be lifted or lowered to suit your needs
- Adjustable head-strap
- Requires 2 x AAA batteries (batteries are not included)



877-1741 1.5X, 3X, 9X, 10.5X Magnification

Eye Glass

- See intricate details in high quality with this magnifier from RS PRO.
- The eye loupe-style unit is frequently used by jewellers and favoured for its high-intensity magnification.



136-8106 10 x Magnification, 25 mm Dia.
544-055 9 x Magnification, 29mm Dia.

Illuminated Pocket Magnifying Glass

- Illumination provided by 2 LEDs
- Selectable white and UV illumination
- Powered by two CR2016 batteries, which are included
- Overall length of 100 mm
- Includes leatherette pouch for protection and storage



123-0925 10 x Magnification, 30mm Dia.

SPECIALIST TOOLS

RS PRO offer a variety of specialist tools used by professionals that have less generic, more specific uses. These include plumbing, woodworking, construction, automotive and vehicular maintenance tools, such as hand drills, hand planers, pipe benders or tyre depth gauges.

Heavy Duty Spring Hook

- Ideal for spring removal
- Stainless steel shaft
- Pulling capacity up to 30kg



405-3294 380 mm, 30kg Pulling Capacity

Hydraulic Bearing Puller

- 8-10 ton hydraulic power & sharp edged 4" bearing splitter.
- Suitable for removal of most tightly fitted parts and damage-free pulling parts of trucks, off-road construction equipment and machinery.
- 10 tonne Hydraulic power unit
- 4" Bearing splitter capacity 75mm-105mm.
- 2 each of 200mm (8") main rods and extension rods for long reach operation.



349-7249 8 Piece Hydraulic Puller Set

3-Jaw Puller

- Chrome vanadium 3-jaw puller available in 100, 150 and 200mm capacities



349-7299 100mm
349-7306 150mm
349-7312 200mm

Hydraulic Puller Sets

- High quality, forged steel provides superior reliability and service
- Precise hydraulic control allows fast, efficient and safe pulling
- Portable and comes in a carrying case
- 8-10 ton hydraulic power unit
- 19 Piece option supplied with 3 x 3 position puller legs and 3 sets of link plates provide you a wide combination for pulling jobs.



349-7261 22 Piece Set - Hydraulic Ram, Twin Head, Triple Head, Ram Nut, Beam, 4" Puller Arm (3pc), 6" Puller Arm (3pc), 8" Puller Arm (3pc), Main Rod 260mm (2pc), Extension Rod (2 pc), Bearing Separator, Nose Extension Set (3pc)
349-7227 19 Piece Set - Hydraulic Ram, Twin/Triple Combination Head, 3 x Three Position Puller Legs, 6x Link Plates, 6x Screw nuts/Bolts/Washers, Ram Extension Rod (Ø1 X L2), Sent Pop (Ø1 X L30mm)

Telescopic Mirrors & Retrieving Tools

- Adjustable inspection mirror probes & magnetic retrieving tools



624-9829 Vacuum Pick-Up Pen Set, 20g Lift Capacity
123-0923 Telescopic Mirror, Silver, 50mm Dia, 170-500mm Length
394-156 Telescopic Mirrors, Red, 32mm Dia, 120-500mm Length
394-172 Telescopic Mirrors, Red, 50mm Dia, 200-780mm Length

Tweezer Set

- General purpose nickel plated steel tweezers supplied in a handy vinyl wallet



618-8386 6 Pieces

Economy Tweezers

- Anti-acid/magnetic stainless steel tweezers with serrated handles
- Various lengths and point types available
- For full range visit our website



136-9832 110mm

136-9836 120mm

136-9838 120mm fine point

136-9851 140mm

General Purpose Tweezers

- High-quality stainless steel serrated handles
- Straight and bent point versions incorporate an anti-twist pin
- Overall length 150mm



545-187 Bent

545-171 Straight

Plastic Tweezers

- Excellent tensile and flexural strength, fatigue and creep resistance
- Low friction, good wear and abrasion resistance
- Low moisture absorption
- Excellent chemical resistance (oils, grease, fuels, organic solvents); not resistant to strong acids, alkalis and oxidising



136-9864 115 mm

Extra Fine Point Tweezers

- High quality for precision manipulation
- Manufactured from stainless steel alloy
- Needle-like points have smooth gripping surfaces
- Overall length 140mm



549-628 140 mm

Venus Range Precision Tweezers

- Manufactured from high grade anti-acid, anti-magnetic stainless steel



238-6182 Extra fine VEN No.4A

238-6176 Fine VEN No.OC9

238-6255 Flat round VEN No.2A

238-6233 Narrow fine VEN No.SS

238-6198 Short fine VEN No.3C

238-6283 Strong standard VEN No.1

238-6249 Strong thick VEN No.00

Cutting Tweezers

- High-quality tweezers for cropping and trimming fine wires
- Parallel, flush cutting edges ground precisely along their 10mm length
- The head profile comes to a point for access in confined spaces
- Cuts 0.25 mm Dia. copper & 0.1 mm Dia. steel wires
- Superb brushed finish



540-2029 Carbon steel

ESD CONTROL, CLEANROOM & PCB PROTOTYPING

Comprehensive range of products for ESD control, cleanroom environments, and PCB prototyping, including ESD mats, grounding accessories, cleanroom apparel, and PCB prototyping boards, ensuring protection and optimal performance in sensitive electronic applications.

PCB Cleaning Brushes

- Fibreglass refill brush
- Easy to use
- Excellent for cleaning small area and objects



514-874 4mm Dia.

514-868 Refillable, 4mm Dia.

514-880 Brass Refill brush, 4mm Dia.

Breadboard Prototyping Solderless Breadboard

- Breadboard prototyping board for experimental set-ups
- 2,854 connection points
- Five colour-coded screw/banana plug terminals



835-2725 266 mm x 168 mm x 24mm

Conductive PCB Holder

- Unique design uses raised studs to secure PCB
- Can be placed on a grounded surface
- Complete with cut-outs for carrying



550-016 353x254x14mm

287-8079 rack w/25 slot,273x210x83mm



Antistatic bubble bags

- For packaging of non-ESD items within an ESD protected area
- Soft texture and flexible 75 micron material
- Ideal for the outer packaging of an already shielded product
- More sizes available online



356-2359 130 x 185mm
356-2365 180 x 235mm

ESD Foam

- Pin insertion foam type
- Not conductive
- Tensile strength of 70 kPa (kilopascals)
- EN 61340-5-1 compliant for electrostatic safety



798-9326 1000 x 800 x 6mm

Anti-static Bags

- Made from 75 micron soft texture and flexible Polyethylene
- Designed for non ESD sensitive components and assemblies
- Bags are blow-moulded with antistatic additives from Low Density Polyethylene (LDPE)



287-7868 100 x 155mm
287-7874 152 x 203mm
484-9073 155 x 254mm
287-8221 203 x 305mm
287-7919 205 x 255mm
287-7903 205 x 305mm
287-7925 254 x 356mm
287-7767 254 x 356mm
287-7931 305 x 406mm
287-7852 75 x 125mm

Antistatic bubble wrap

- Blow-moulded with anti-static additives from LDPE and LLDPE
- Soft texture and super flexible
- Two layer extrusion with calendar role to thermoform bubble
- Provides a "faraday cage" to protect inside components
- Easy to cut while still provide great strength in order to not tear.
- Can be heat-sealed



356-2315 5000 x 5000mm
639-1920 5000 x 750mm

Black Conductive Bags

- Ideal packaging for tubes of IC's whilst components in an EPA
- Made from LDPE with carbon that protects contents from damage via electromagnetic wave and static
- This product can be heat sealed and offers medium level static protection
- Film thickness 75 micron



550-072 127 x 203mm
550-088 203 x 254mm
550-094 252 x 305mm
550-101 305 x 406mm
550-117 406 x 508mm

Heat-sealable Static Shielding Bags

- Designed to protect ESD sensitive components and assemblies from all harmful aspects of static electricity
- Heat-sealable with a 3-layer buried 'metal' design offering a dissipative outer, anti-static inner
- Dimensions quoted are internal dimensions - packs of 100



182-8821 152 x 254mm
182-8837 203 x 254mm
182-8792 76 x 127mm

Zip-locking Static Shielding Bags

- Zipper topped bags for protecting sensitive equipment from ESD
- damage
- Dissipative outer section, antistatic interior



431-9538 102 x 152mm
431-9544 152 x 203mm
431-9550 254 x 305mm
431-9566 305 x 406mm
431-9572 457 x 457mm

Anti-static Gusseted Bags

- Heavyweight 400 gauge material ideal for protecting finished goods such as CPU's and monitors etc.
- Film thickness 75 micron
- Gusseted design ideal for rectangular and square objects
- Made of Low Density Polyethylene (LDPE)



397-4291 300/500 x 650mm

ESD Film

- Electrostatic Discharge safe film
- Made from dissipative material
- Surface resistance of 108 Ω to 1011Ω
- Thickness of 25 microns
- Conforms to ANSI/ESD S20.20:2007 and BS EN 61340-5-1:2007, the recognised international standards for ESD Protected Areas



815-7012 500mm x 300m

ESD Laboratory Coats

- Ideal white coat for engineering, medical and all lab work
- ESD symbol on the breast pocket of the lab coat
- Unisex lab coat suitable for men and women
- Button Closure
- Reusable
- Dissipative



789-8087 Medium
789-8090 XL
789-8093 XXL

ID Badge

- Used in laboratories and engineering environments where you need to protect equipment from ESD.
- Polypropylene (PP) material has good chemical resistance, so it's safe for use in environments where there are potentially corrosive chemicals.



815-7019 Black

Anti-static Heel Grounders

- High quality long life heel grounders
- With or without 1MΩ resistor
- Comfortable and easy to fit
- Suitable for all flat shoe type



363-2931 Black with adjustable strap - 1MΩ

Anti-static Heel Grounders

- High quality long life heel grounders
- With or without 1MΩ resistor
- Comfortable and easy to fit
- Suitable for all flat shoe type



287-7565 Blue heel grounder - 0MΩ
217-9265 Dayglow heel grounder - 1MΩ

Anti-static Heel Grounders

- High quality long life heel grounders
- With or without 1MΩ resistor
- Comfortable and easy to fit
- Suitable for all flat shoe type



466-8559 Nylon disposable heel grounder for shoe

Coiled ESD Cords

- High quality long life yellow coil cord with 10mm stud connectors
- Integral 1MΩ, 2MΩ or 4MΩ resistor
- Soft polyurethane strain relief



273-6701 Stud to 4mm plug cord,1.8m L 1MΩ
287-7391 Stud to 4mm plug cord,3.6m L 2MΩ

Coiled ESD Cords

- High quality long life yellow coil cord with 10mm stud connectors
- Integral 1MΩ, 2MΩ or 4MΩ resistor
- Soft polyurethane strain relief



291-9489 1.8m L 2MΩ
552-905 1.8m L 4MΩ
273-6717 Stud to stud cord,1.8m L 1MΩ

Coiled ESD Cords

- High quality long life yellow coil cord with 10mm stud connectors
- Integral 1MΩ, 2MΩ or 4MΩ resistor
- Soft polyurethane strain relief



129-4874 Stud to stud cord, 2m L, 1MΩ

ESD Wrist Strap and Cord Sets

- Comfortable & adjustable wristband with an easy to use
- adjustable clip which makes taking on & off easy
- 1.8m coiled cord provides lots of movement & flexibility



287-7379 Wrist strap & cord 10mm stud to croc clip

287-7385 Wrist strap & cord 10mm stud to stud

392-163 Wrist strap only

798-9290 4 mm Anti-Static Wrist Strap

Anti-Static ESD Grounding Wrist Strap & Cord Set

- Provides protection from static electricity
- Resistance: 10K Ohm (Wrist Strap) & 1M Ohm 10% (Cord)
- Adjustable wrist strap to fit any size wrist



192-3678 1.5m Cord

ESD Wrist Strap and Cord Sets

- Wrist strap with plastic exterior encased in metal
- Adjustable with snap links for universal fit
- Coiled cord insulated with Polyurethane (PU)
- End with 4mm socket snap, other with 4mm banana plug



798-9284 4mm

Wrist Straps and Cords

- Premium quality fabric or expandable metal wrist band and cord set with choice of terminations
- Fully adjustable wrist straps fits all sizes - 10mm stud
- Supports ESD S20.20 and EN 61340-5-1 ESD control programme compliance



798-9275 Metal wrist + stud-4mm cord - Black

287-7414 Metal wrist + stud-4mm cord - yellow

Anti-Static Wrist Strap

- Grounding wrist strap in a blue fabric
- Stud size of 4 mm
- Resistance of 80 to 90 Ω/inch
- For use with a coiled cord containing a 1 megohm current limiting resistor



798-9294 4mm Stud

ESD Grounding Cord

- Straight cord style in yellow colour
- Connecting lead resistance of 0 Ω
- Meets ESD S20.20 Electrostatic Discharge Association standards for the development of electrostatic control programmes protecting equipment prone to high electrostatic discharge



129-4975 115mm cord length

ESD Grounding Cord

- A straight cord and a conical head with 1 megaohm resistor
- The grounding wire's built-in 10 mm stud will connect the socket to an ESD safe mat and the low profile head prevents the cord from being accidentally knocked



798-9335 10mm Low Profile Ground Cord, 1 ohm, 4.5m

ESD Common Ground Points

- Common point ground wires ideal for use on benches or with field service kits
- Designed for grounding mats / laminates and operators to ensure no potential difference
- Supports ESD S20.20 and EN 61340-5-1 ESD control programme compliance



129-4931 Ground Point - 1.0m L 1Mohm

ESD Grounding Cord

- Reusable black cord
- Single wire type
- Stud size of 4 mm
- Polyurethane insulation of 2.5 mm
- Dielectric strength of 1250 V DC for at least one minute



798-9304 4mm Stud-Banana Coiled Cord, 1.8m

Anti-static Field Service Kits

- Kit contents: high quality static dissipative mat (2 x 10mm male snaps); adjustable wrist strap set; 4m EBP ground cord; black wide jaw crocodile clip; stacking banana jack/10mm stud adaptor; carry pouch
- Mat includes 2 pockets each 185mm x 285mm
- Surface resistance 10E6-10E8 ohms per IEC 61340-2-3



681-1231 Heavy duty field service kit

Earth Bonding Boxes

- Fits under the bench
- Connects up to 3 elements of the EPA to ground
- Complete with 2m earth lead with spade terminals
- Moulded from ABS with rounded corners



298-3957 Bo x ,3 x 10mm stud

298-3941 2X4mm SCKTS,1X10mm STD

ESD Universal Snap Mounting Kit

- Kit which allows you to provide a grounding path ensuring ESD protective materials and people have the same electrical potential
- The kit includes:
 - 10 mm Stud
 - 10 mm Socket
 - Threaded back washer
 - Conical nut
 - Long screw
 - Short scr
 - ESD com



122-9148 Universal snap kit, 10mm socket

Earth Bonding Point Box

- Fits in the bench top
- Connects up to 3 operators to ground
- Complete with 2m earth lead with ring terminal
- Easy to fit using self adhesive pads



392-135

Earth Facility Bracket

- Hard wire different elements of the EPA to ground
- Complete with 2 m earth lead
- Moulded from yellow ABS with rounded corners
- Size: 40 x 45 x 12 mm
- Supplied with two wood screws and one M5 ring terminal - easy to mount
- Grounding hub for earth bonding points - can receive several wires



298-3963 2m Earth Lead

ESD Earth Bonding Bracket with Stud

- Fits under the bench or to a wall
- Connects operators and other elements of the EPA to ground
- Complete with 2 m earth lead
- Moulded from ABS with rounded corners



298-3913 4mm Stud x2

287-7492 Earth bonding bracket,3x10mm stud

Press Studs

- Two part conductive Male and Female Studs
- Stud & Post Set - pack of 100



291-9596 10mm Stud Size, Adapter

ESD Common Ground Points

- Common point ground wires ideal for use on benches or with field service kits
- Designed for grounding mats / laminates and operators to ensure no potential difference
- Supports ESD S20.20 and EN 61340-5-1 ESD control programme compliance



129-4947 Anti-static stud fix adaptor

ESD Rack Bonding Point with Stud

- Easy to fit to rack or cabinet - only 25mm x 35mm in size
- Complete with isolated screw for earth connection
- 1 x 10mm male stud connection
- Supports ESD S20.20 and EN 61340-5-1 ESD control programme compliance



392-141 10mm Stud Size, Universal Snap Kit

ESD Bench Mats

- ESD protective matting aids in the prevention of damage to ESD sensitive items and assemblies from Electrostatic Discharge.
- There are two different types of matting available: ESD working surface matting and ESD floor matting.



787-2102	Bench, 3 Layer, 1200 x 600cm, 3 mm Thickness, Blue
466-1643	Blue - 600 x 1200mm
466-1659	Floor, 3-Layer, Vinyl Mat, Grey, 120x60cm, 3.2mm Thickness, Grey, 1 x 10 ⁶ - 1 x 10 ⁸ Resistance
787-3120	Floor Mat, Black, 120x60cm, 3mm Thickness, Black, 104
787-3139	Conductive Rubber Mat, Bench, 2-Layer, Vinyl Mat, Grey, 120x60cm, 3.2mm Thickness, Green, 104
787-3114	Bench/Floor Mat, Black - 1.2m x 0.6m x 2mm

Cleanroom Tacky Mats

- LDPE Floor Mat
- Remove contamination on contact
- Peel to expose a clean surface (30 sheets)
- No washing or cleaning of mats with messy fluids and mops
- Use with or without a frame, low profile construction
- Full adhesion bottom holds floor securely yet easy to remove and leaves no residue



829-5281	Blue, 1.14m x 460mm x 1.65mm
829-5293	Blue, 1.14m x 660mm x 1.65mm

Antistatic Toothbrush

- Rectangular shape
- Full product length of 245 mm
- Handle length of 225 mm
- Bristle dimensions of 20 (length) x 18 mm (width)
- Handle resistivity of 10⁴ to 10⁵ Ω
- Bristle resistivity of 10⁸ to 10¹⁰ Ω
- Not fully anti-static
- Not suitable for cleanroom usage
- Complies to ANSI/ESD S20.20:2014 and BS EN 61340-5-1:2007 Electrostatic Control standards



287-8186	Rectangular, 60mm
-----------------	-------------------

Conductive PP Brush

- Made from black conductive polypropylene, designed to absorb the charge generated and pass it to the ground
- For use in the electronics industry where traditional brushes can create undesirable static charge
- ANSI/ESD S20.20 1999, EN 61340-5-1



125-0302	144 x 50 x 20mm
-----------------	-----------------

Antistatic Circular Brush

- Circular-shaped ESD-safe brush
- Conductive rounded plastic handle
- Bristles: 80% nylon, 20% pig hair
- Resistivity: 10⁴ to 10⁶ Ohms
- Suitable for electronics industry, abrasion, residue removal
- Complies to ANSI/ESD S20.20:2014, BS EN 61340-5-1:2007 Electrostatic Control Standards



287-8170	Circular, 6.3mm
-----------------	-----------------

Plastic Lab Stool

- Essential for clean-room environments
- Designed to let you sit and move around as safely as possible while you're working
- Features footrests to help you find a comfortable seated position.
- Conforms to European EN 61350-5-1 standards, for resistance to electrostatic discharge.



125-2401	Black
-----------------	-------

Anti-Static ESD Scissors

- Designed for EPA and clean room environments
- Tested at both 12% and 50% RH at 23°C
- Permanently Antistatic



184-6690	178 mm x 8 mm
-----------------	---------------

Cleanroom Dry Wipes

- A choice of durable and highly-absorbent cleanroom wipes with ultra-low lint
- Dry wipes: Double-knit 100% polyester heavy-weight wipes with laser-sealed edge
- Cellulose polyester: Hydro-entangled, non-woven wipes containing 55% cellulose and 45% polyester with sterile option

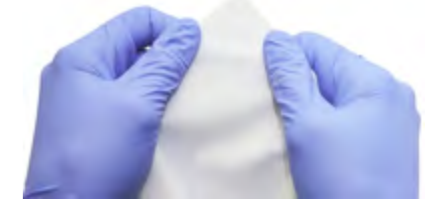

829-5142	12x12 Poly/Cellulose, 100 wipes
829-5136	9x9 Poly/Cellulose, 100 wipes

Anti-splash Pump Dispensers

- Allows accurate delivery of solvents and cleaners
- Anti-splash design
- Anti-static polymer material makes it compatible in an ESD workplace
- 240 ml (8 oz.)



423-7391	Pink, 240ml
798-9323	Blue, 180ml
798-9329	Blue, 120ml

ESD Waste Bins & Bags

- Pink ESD waste bags made from a low tribo-charging material and matching waste bins
- Bins are made of black conductive Polypropylene (PP) material and are 40 litre capacity
- Both items conform to EN 61340-5-1



125-2404	Bags, Pink, 40L
125-2403	Bin, Black, 40L

Ring Binder Spine

- Non-conductive
- Not anti-static
- Safe for use in cleanrooms



733-946	A4, 40 mm x 320 mm, 25mm ring depth,
----------------	--------------------------------------

Clean Room Autoclavable Paper

- Made from polymer-bonded cellulose fibres
- Latex free
- Chemical resistant
- Sterilisable by ETO (ethylene oxide), steam or gamma irradiation
- Suitable for printing and photocopying
- Complies to ANSI/ESD S20.20:2014 and BS EN 61340-5-1:2007 Electrostatic Control Standards



829-5180	A4, White, 70G, 235 mm x 315 mm, 250 sheets
-----------------	---

6 Piece ESD Tool Kit with Case

- ESD capacity between 6-9 OHM
- With plastic box to storage
- Long nose pliers for easy operation at deep and narrow working space
- Diagonal cutting pliers suitable for copper wire below dia.1.3mm



864-0870 PH0X50, PH1X50, SL2.0X50, SL3.0X50 -50MM, 130mm long nose pliers, 115mm diagonal cutting pliers

Adhesive Grid Tape with ESD Symbol

- Adhesive grid tape with ESD symbol
- Conductive polypropylene surface - low charging
- For manual and automatic tape dispensers



443-9799 34m x 12mm
443-9812 34m x 18mm
443-9828 34m x 24mm
443-9834 34m x 48mm

ESD Safe Micro End Cutter

- An ESD Micro End Flush Cutter with a narrow jaw designed for precision, straight cuts and is ideal for use in hard to access areas due the narrow head design.
- Anti-reflective phosphating surface treatment
- Maximum cut of 0.81mm (20AWG Copper Wire)
- Cutting force of 3kg
- Steel Thickness of 2mm



238-0814 132mm

ESD Safe Micro Needle Nose Pliers

- Anti-reflective phosphating surface treatment
- Steel Thickness of 2mm
- Weight of 60g



249-8673 136mm
249-8656 138mm

ESD Fine Curved ESD Safe Tweezers

- A high quality ESD tweezer designed for accuracy and precision and layered with an ESD Safe powder coating for use on or around sensitive equipment.
- Constructed from Low Carbon Austenitic Steel for excellent strength and durability, strong corrosion, chemical resistance and anti-magnetic properties. Reliable, accurate and constructed to last.
- Fine curved tweezer tips
- ESD coating



238-0708 120mm

General Purpose ESD Pliers

- Pressed steel frames
- Riveted lap joints
- Precision ground 3mm steel jaws
- Ribbed soft plastic grips and lightweight return spring
- Integral stop prevents handles opening too far



245-0536 Needle nose
245-0558 Serrated jaw

ESD Pliers & Cutters

- Made from high carbon steel
- Protected from electrostatic discharge



864-0791 Bent nose 6"
161-063 Flat nose 120mm
864-0782 Flat nose 6"
864-0788 Long nose 6"
864-0794 Round nose 5.5", Spring action
161-079 Snipe nose 120mm

ESD Safe Screwdrivers

- Constructed from Chrome-Vanadium Molybdenum Steel for excellent strength and durability
- Set into a bi-material ergonomic handle to reduce hand fatigue over extended use



249-8663 160mm Phillips PH00 x 60mm blade
249-8665 175mm Sotted 2.5mm x 75mm blade

ESD Pliers & Cutters

- Suitable for SMD and leads, ESD safe
- Black coated handle prevents electrostatic discharge
- Facilitates optimum access, with spring action
- Overall length: 5 inches, cutting capacity: <1.6mm copper wire
- Blade made of high carbon steel, handle made of PP ESD material



864-0805 5" heavy
864-0772 4.5"
864-0785 5"
864-0798 5" plus safety clip

Micro-Tek ESD Shears

- Electronic cutters
- Jaw length of 20 mm
- Maximum cutting capacity of 0.8 mm
- Overall length of 128 mm
- Electrostatic discharge (ESD) safe



847-2967 Mini
847-2961 Kevlar Fibre Optic

IC Storage Boxes

- Designed to store IC's and other small components
- Ideal for use in the field in stores and for transit
- Fitted with 6mm high dense foam in the base



420-1386 229 x 126 x 23mm
420-1409 229 x 126 x 42mm
550-864 40 x 40 x 13.5mm
550-870 77 x 55 x 19mm
287-8091 89 x 64 x 16mm

ESD Conductive Storage Containers

- Manufactured using antistatic, carbon conductive particles/fibres which produce a low static charging container for the storage of
- static sensitive items.
- This makes them ideal for use as part of a complete ESD control programme, as defined by BS IEC 61340-5-1:2007



550-325 ESD Black, Size 2, 75 x 100 x 165
550-331 ESD Black, Size 3, 132 x 150 x 240

Conductive Polypropylene ESD Box

- Snap-close lid, melting temp: +80°C to +90°C
- Static shielding, surface resistivity: 10⁶ Ω
- For shipping/storage of circuit boards
- Not anti-static or dissipative
- Complies with RoHS standards
- Complies with ANSI/ESD S20.20:2014



217-9221 140 x 106 x 38mm
820-810 232 x 130 x 33 mm

Conductive Component Box and Lid

- Black, foam filled conductive component box with attached black lid is a carbon black filled conductive thermoplastic compound that is based on polypropylene.
- This conductive plastic box allows the safe storage or transit of ESD-sensitive parts and components by effectively forming a Faraday cage.



815-7003 16 x 15 x 12mm

EPA Floor Marking Tape

- Ideal for marking out the floor area of the EPA
- Includes the ESD logo and text



340-7533 66m x 50mm

Anti-static Packaging Tape

- Self-adhesive PVC ESD packaging tape ideal for sealing secondary packaging
- Text reads 'ATTENTION, ATTENZIONE, ACHTUNG' with ESD logos



733-980 66m x 50mm

PLA Filament

- High-quality polylactic acid (PLA) material
- Hardens rapidly without deforming for accurate prints
- Made from plant-derived sugars, it is biodegradable and environmentally sustainable



832-0214	Black, 1.75mm, 1Kg
125-4335	Black, 1.75mm, 2.3Kg
832-0406	Black, 1.75mm, 300g
832-0226	Blue, 1.75mm, 1Kg
832-0239	Green, 1.75mm, 1Kg
832-0251	Grey, 1.75mm, 1Kg
832-0210	Natural, 1.75mm, 1Kg
832-0220	Red, 1.75mm, 1Kg
832-0412	Red, 1.75mm, 300g
832-0245	Silver, 1.75mm, 1Kg
832-0223	White, 1.75mm, 1Kg
125-4337	White, 1.75mm, 2.3Kg
832-0400	White, 1.75mm, 300g
832-0232	Yellow, 1.75mm, 1Kg
125-4336	Black, 2.85mm, 1Kg
832-0264	Black, 2.85mm, 1Kg
832-0309	Fluorescent Orange, 2.85mm, 1Kg
832-0270	Red, 2.85mm, 1Kg
832-0295	Silver, 2.85 mm 2.3 Kg
832-0273	White, 2.85mm, 1kg, 2.85 mm 2.3 Kg

PET- G Filament

- Polyethylene terephthalate Glycol-Modified (PETG) filament
- It barely warps and produces no odours or fumes when printed
- Non-biodegradable, but it is 100% reclaimable
- Hydrophobic and therefore does not absorb water



891-9309	EZ-GLASE Black, 1.75mm - 500g
891-9286	EZ-GLASE Clear, 1.75mm - 500g
891-9303	EZ-GLASE White, 1.75mm - 500g

CARBON-P Filament

- Increased impact and heat resistance (HDT) up to 80°C
- Water-resistant
- Nozzle temperature of 210 - 250 °C
- Matt surface



910-7034	Black
----------	-------

ABS Filament

- Acrylonitrile Butadiene Styrene (ABS) material
- Very light and durable which makes ABS particularly suitable for tools, toys and all kinds of utensils
- Minimal warping
- Reliable bed adhesion
- Highly durable and more flexible than PLA



832-0311	Black, 1.75mm - 1Kg
832-0315	White, 1.75mm - 1Kg
832-0282	Yellow, 1.75mm - 1Kg

ENCLOSURES & SERVER RACKS

RS PRO offers server racks, electrical enclosures, junction boxes, and wall-mount enclosures for equipment protection.

Metalclad Surface Boxes

- 1 or 2 gang surface mount metal back boxes



361-1962	Grey, 1 Gang
361-1984	Grey, 2 Gang

Selective Entry Junction Boxes

- Cable junction box
- Selective entry
- Numbered entry points



776-7640	20A Junction Box, 4 Terminal Star Arrangement Dia. 76mm
776-7646	5A Junction Box, 4 Terminal Star Arrangement Dia. 62mm
776-7659	30A Junction Box, 3 Terminal Line Arrangement Dia. 76mm

Inline Junction Box

- Current rating: 32A, Voltage rating: 450V
- Brass contacts, nickel-plated
- Operating temperature: -20°C to +125°C
- Length: 115mm (3-pole), 130mm (5-pole)
- Diameter: 26.5mm (3-pole), 32.0mm (5-pole)
- Cable gland size: M20 (3-pole), M25 (5-pole)
- 3-pole connectors accept 5-8mm (inner and outer seal), 8-13mm (outer seal)
- 5-pole connectors accept 8-12mm (inner and outer seal), 12-17mm (outer seal)



469-1795	3 Pole
469-1818	5 Pole

Surface Pattress Back Boxes

- White plastic surface pattress boxes
- Choice of single or double gang



775-8103	1 Gang 19mm
775-8107	1 Gang 28mm
775-8116	2 Gang 28mm

Mini PVC Trunking Boxes

- Mini trunking surface boxes with knockouts in white PVC are robust and heavy duty
- Designed to match white mini PVC trunking



917-1615	2 Gang
917-1637	2 Gang ,32mm

Black Enamel Adaptable Boxes

- Black Enamel Finish
- Steel Construction



763-9204	100 x 100 x 50mm
763-9208	150 x 150 x 50mm
763-9201	75 x 75 x 50mm

Stainless Steel Adaptable Box Enclosure

- Adaptable box enclosures in satin-brushed stainless steel
- Fitted with a gasket to give a weatherproof seal for damp conditions
- IP66 / IP69K Rated



121-9691	100 x 100 x 50mm
471-1580	100 x 100 x 50mm
121-9693	100 x 100 x 85mm
121-9692	160 x 100 x 50mm
121-9694	160 x 100 x 85mm
471-1625	160 x 160 x 85mm
121-9696	160 x 160 x 85mm
121-9695	220 x 100 x 85mm
121-9697	220 x 160 x 85mm
471-1631	220 x 220 x 85mm
121-9699	280 x 220 x 85mm

Adaptable boxes

- Galvanised Steel finish
- Knock out size 20/25mm



563-898	75 x 75 x 50mm
---------	----------------

Galvanised Steel Adaptable Boxes

- Lids are secured by M5 x 8mm mushroom head screws
- Galvanised finish



763-9248	100 x 100 x 50mm, 5 Knockouts
763-9242	150 x 150 x 50mm, 6 Knockouts
763-9251	75 x 75 x 50mm, 10 Knockouts
563-905	100 x 100 x 50mm, 12 Knockouts
563-911	150 x 150 x 50mm, 16 Knockouts

Angle Brackets with Fixing Holes

- 90 Degree
- Zinc plated mild steel angle brackets with fixing holes for an easy and secure fastening with the appropriate screw.



427-991	14.6 mm x 15 mm
427-997	15 mm x 25 mm
428-001	15 mm x 50 mm
428-007	15 mm x 70 mm

Angle Brackets

- Made of galvanised steel which means it's not only sturdy and rust-free but also resistant to harsh environmental conditions.
- Used to connect Channel/Strut together at a 90° angle



176-6902	3 Hole, 57 x 90mm, Bag of 5
176-6904	3 Hole, 50 x 96, Bag of 5
749-1680	4 Hole, 15 x 50 mm, Bag of 10
749-1686	4 Hole, 30 x 12 mm, Bag of 10
749-1699	4 Hole, 70 x 50 mm, Bag of 5
176-6905	2 Hole, 40 mm, Bag of 10
176-6899	4 Hole, 6 x 102mm, Bag of 5

Flat Brackets

- Zinc Plated Steel



397-4976	L Shape
397-5014	Straight
397-5008	T Shape

Angle Brackets

- L-shaped fasteners designed to connect any two parts at a 90-degree angle
- Made from steel with zinc plating



397-4982	6 Hole, 200 x 250 mm
----------	----------------------

Mounting Plate for Small Panel Terminals

- Designed to secure twin small panel terminals in place, resulting in a typical terminal post assembly
- The two separate parts fit together easily and are held together by the panel terminal fittings
- Results in a safe and secure connector assembly



404-856

Compression Latch

- IP65 sealed Locked indicator
- Vibration resistance when locked
- Available in stainless steel and zinc alloy



136-3616	Stainless Steel, 22.2mm x 20.2 mm
136-3615	Zinc Alloy, 22.2 mm x 19.2 mm

Swing Handle

- Tamperproof
- Increased security
- Keyway has a spring-loaded shutter
- Supplied with 2 keys



136-3618	Black 160 mm x 35 mm x 12 mm
136-3619	Black 160 mm x 35 mm x 10 mm

Cable Entry Brush Plate

- Letterbox type made from high impact polypropylene
- Fitted with black nylon brush inserts
- Cut-out dimension required for installation: 280 x 49 mm



738-8685	Brown
738-8681	White

Server Cabinet Ventilation Grilles

- Louvered, Stainless Steel



348-7309	Ventilator 1
348-7315	Ventilator 2
348-7321	Ventilator 3
348-7337	Ventilator 4

HVAC, FANS & THERMAL MANAGEMENT

RS PRO provides HVAC equipment like air conditioners, fans, heaters, and thermal management products such as heat sinks and thermal pastes.

Standard Pleated Panel Filters

- Intrepid media
- G4 Grade
- Maximum airflow
- Varying thickness available in range



730-2883	G4, Pleated Panel, White, 292 x 594 x 95mm, MERV Rating 8
730-2895	G4, Pleated Panel, White, 292 x 292 x 45mm, MERV Rating 8
730-2892	G4, Pleated Panel, White, 292 x 594 x 45mm, MERV Rating 8
730-2877	G4, Pleated Panel, White, 394 x 622 x 45mm, MERV Rating 8
730-2873	G4, Pleated Panel, White, 445 x 445 x 45mm, MERV Rating 8
730-2849	G4, Pleated Panel, White, 594 x 594 x 95mm, MERV Rating 8
730-2811	G4, Pleated Panel, Blue, 594 x 594 x 45mm, MERV Rating 7

Coolant Hose Kits

- Flexible coolant hose kit
- Made from durable, heat-resistant polyoxymethylene
- Hose Colour: Blue, Pantone (3025C)



623-5094	1/2 in, 2 x 5.5-in hoses
623-4978	1/4 in, 20x 11-in hoses
623-5397	Assorted 1/4" modular hose accessories, 1x 11-in hose, 3x nozzles (1/16 in, 1/8 in, 1/4), 2x NPT connectors (1/8 in, 1/4 in)

Air Filter Clip Filter

- High capacity disposable filters
- Better than basic level of filtration
- Intrepid® filter media delivers a constant level of filtration over its life
- Water repellent AquaKote® card frame
- Made from continuous fibres so will not shed



730-2959	2 in
----------	------

Digital & Programmable HVAC Thermostat

- Digital temperature display
- Push button control with delay to prevent accidental over riding
- Change over contacts for heating or cooling applications
- Uses 2 AAA batteries (not supplied) allowing 2-wire operation



407-5979	+5°C › +35°C
407-5985	7 days, +5°C › +35°C

Mechanical Room Thermostat

- Tamperproof: has a plain front cover concealing the temperature adjustment control and a temperature set-back of approximately 6°C (ideal where frost protection is required).
- Surface mounting with a thermoplastic front cover suitable for industrial and commercial applications
- Fitted with a shunt accelerator heater to ensure low switching differential and to avoid overshoot



458-361	4A, 250 V ac, +5 › +30 °C
458-367	4A, 230 V ac, +5 › +30 °C

Polyether Reticulated FR Foam for Water Filtration

- Uniform, homogenous and controlled open celled reticulated foam
- Excellent resistance to water, soap, oils and lubricants, along with resistance to hydrolysis
- Ideally suited for water and air filtration, for applications in aquatic filter, air conditioning units, automotive filters, oil mist removal filters and separation filters



203-5149	G3, Blue, 12mm, 45PPI
----------	-----------------------

Synthetic Fire Rated Filter Media

- Thermobonded
- Flame retardant
- Polyester media
- G4 Grade
- Thermal stability 90°C



122-1774	G4, Pad, 1.6m x 1m x 20mm
122-1773	G4, Roll, 20m x 1m x 20mm
827-9529	G4, Roll, 1000 x 2000 x 20mm

Polyester Filter Media Roll

- A synthetic (100% polyester fibre) filter media
- Suitable for use as a general pre-filter for HVAC
- 100% Polyester fibres
- Media velocity: 1.5 m/s
- Filter class (to EN770:2012): G3
- Dust holding capacity: 400 g/n
- Thermal stability: 100°C (brief)



122-1772	G3, Pad, 1m x 1.6m, 14mm thickness
122-1771	G3, Roll 1m x 20m, 10mm thickness
827-9510	G3, Roll, 1m x 2m, 10mm thickness
122-1775	G4, Roll, 20 x 2 m, 50mm thickness

PUR Foam Media

- Made of polyurethane foam
- This open cell foam in black colour, is easy washable and offers efficient filtration.



827-9605	G3 Grade, 1000 x 2000 x 6 mm
827-9617	G3, 1220 x 2000 x 20 mm

PET Pad Filters & Air Filter Frames

- White colour
- G4 filter grade
- Galvanised steel case

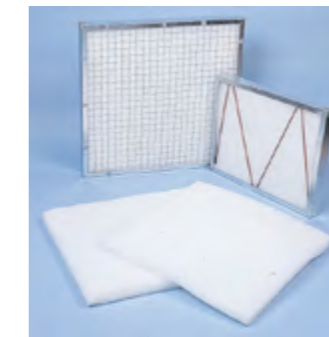

730-2918	G4, 394 x 495 x 45mm
730-2912	G4, 495 x 495 x 45mm
730-2930	Frame only, 495 x 394 x 45mm

Polyester Reticulated FR Foam for Air Filtration

- Uniform, homogenous and controlled open celled reticulated foam
- Excellent resistance to UV light, oils, lubricants, solvents, dilute acids and alkalis
- Ideally suited for air and dust filtration

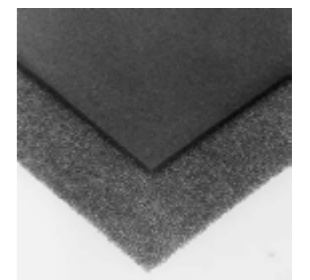

203-5146	G3, Black, 12mm, 30PPI
----------	------------------------

Fixed Blade Louvres

- For external use
- Internal rain lip set at a pitch of 38mm and an angle of 45°
- Undrilled flanges with fully welded and finished mitre corners
- Mill aluminium or stove enamelled brown finish



- 432-801** 300 x 300mm aluminium finish
- 432-788** 300 x 300mm brown finish
- 432-817** 450 x 450mm aluminium finish
- 432-794** 450 x 450mm brown finish

White Aluminium Grille

- Aluminium material
- Egg crate slat configuration



432-687 450 x 450 mm

Aluminium Grilles

- Aluminium material is lightweight
- Egg crate slat design
- Corrosion-resistant
- Flange with pre-drilled holes
- Easy installation

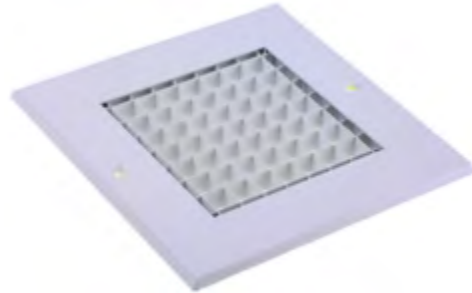

- 432-659** White, 125 x 125mm
- 432-665** White, 200 x 200mm
- 432-671** White, 300 x 300mm
- 185-4713** White, W/FLANGE, 300 x 300mm

Aluminium Grilles

- Aluminium material
- Egg crate slat configuration
- Features a flange with pre-drilled holes for quick and easy installation and a secure join

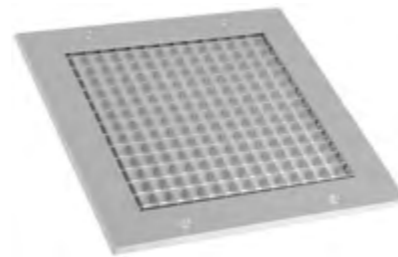

- 432-700** Silver, 200 x 200mm
- 432-716** Silver, 300 x 300mm

Non Vision Door Grilles

- Slim profile allows 2 to be installed back-to-back within a standard door
- Enables air transfer where through vision is not required
- Made from extruded aluminium with fully welded and finished mitred corners
- Pre-drilled fixing holes



- 432-823** 347 x 347mm
- 432-839** 450 x 450mm

Spigot Plate

- Galvanised steel material

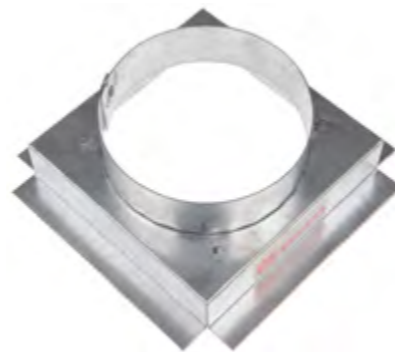

- 432-873** 125 x 125 mm
- 432-889** 200 x 200 mm
- 432-895** 300 x 300 mm

TORCHES

The RS PRO torches range provides a diverse selection of reliable and high-performance models, including LED torches, rechargeable torches, headlamps, and tactical torches, designed to meet a wide range of lighting needs.

LED Pen Torch

- Compact penlight torch uses an extra strong CREE XPG LED to offer a bright light with an easy twist flood-to-spot feature for closer lighting inspection
- IP56 water resistant and up to 1 m impact resistant, making it suitable for harsh environments like worksites



200-6747 180 lm, 150 mm

UV LED Torch

- Flood to spot beam twist zoom
- 1m impact-resistant
- IPX4 water-resistant



220-6819 Red 2.7 lm, 147 mm

Aluminium LED Torch

- Long life LED lamp
- Luminosity of 600 lm
- Easy to adjust beam
- 3 beam settings - high, low and strobe
- Not rechargeable
- Four AAA batteries included



- 196-4195** 250 lm, 150 mm
- 196-4196** 600 lm, 163 mm

LED Torch

- The anti-roll body ensures that Torch securely stays in 1 position rather than rolling off the surface.
- Twist flood to spot beam control, that allows users to either create a long-range light is a more focused circular beam of light or create a wide pattern of light.
- A tactical rubberised switch
- The nylon wrist strap prevents the user from accidentally dropping the torch.



176-6034 1400 lumen

ACCESS, STORAGE & MATERIAL HANDLING

RS PRO offers products such as shelving units, storage bins, pallet trucks, and lifting equipment.

Steel Kick Step Stool

- Provides easy step up access preventing excessive stretching
- Retractable spring mounted castors and anti-slip rubber treads and base surround
- Steel constructed with anti-slip rubber treads and base surround



621-1745 2 Tread, Black, 0.4m Platform Height

Folding Step Ladders

- Steel Construction for strength and durability
- Rubber handle on top bar for comfort and grip
- Non-slip ribbed rubber treads to help you climb more safely
- Foldable design to save space and store with ease
- Working load of up to 150kg



877-6828 4 Tread, 1.29m

877-6819 3 Tread, 1.065m

Aluminium Stepladder

- Rubber feet & aluminium side arms help prevent slips & twists as there are no tapes or flimsy arms to break
- Lightweight & easy to carry



187-4991 6 Treads, 1.26m, 4.5kg

3 Way Glass Fiber Steps

- Locking mechanism to ensure increased safety
- Roller wheels for ease of movement on a building/ against a wall
- Available for use as a stepladder, extension ladder freestanding extension ladder
- Certified to EN 131 Professional & EN 50528



187-4980 3 x 8-Step Treads, 21kg

Stackable Storage Bins

- Available in 7 sizes, 6 colors, and ESD options
- Strong, heavy-duty design with reinforced base and sides
- Durable, resistant to industrial solvents, temperature range -15°C to +50°C
- Hygienic, smooth inside faces prevent grease build-up
- Index card slot for easy product identification
- Black recycled option available for cost-efficiency and eco-friendliness



484-4006 Red, Size 2, 75 x 100 x 165

484-4034 Red, Size 3, 132 x 150 x 240

484-3845 Red, Size 6, 182 x 420 x 375

350-5845 Red, Size 7, 200 x 310 x 520mm

484-3996 Blue, Size 1, 50 x 100 x 90

484-4028 Blue, Size 2, 75 x 100 x 165

484-4056 Blue, Size 3, 132 x 150 x 240

484-4107 Blue, Size 4, 132 x 205 x 350

484-4157 Blue, Size 5, 182 x 205 x 350

484-4185 Blue, Size 6, 182 x 420 x 375

350-5873 Blue, Size 7, 200 x 310 x 520mm

484-4062 Yellow, Size 3, 132 x 150 x 240

484-4113 Yellow, Size 4, 132 x 205 x 350

484-4191 Yellow, Size 6, 182 x 420 x 375

350-5867 Yellow, Size 7, 510 x 315 x 200mm

469-6778 Orange, Size 3, 132 x 150 x 240

469-6740 Orange, Size 6, 182 x 420 x 375

484-4040 Green, Size 3, 132 x 150 x 240

484-4090 Green, Size 4, 132 x 205 x 350

484-4179 Green, Size 6, 182 x 420 x 375

350-5895 Green, Size 7, 200 x 310 x 520mm

315-1123 White, Size 1, 50 x 100 x 90mm

315-1139 White, Size 2, 75 x 100 x 165mm

315-1145 White, Size 3, 132 x 150 x 240mm

315-1151 White, Size 4, 132 x 205 x 350mm

315-1173 White, Size 5, 182 x 205 x 350mm

315-1189 White, Size 6, 182 x 420 x 375mm

909-6906 Black Recycled, Size 2, 75 x 100 x 165mm

909-6915 Black Recycled, Size 3, 132 x 150 x 240mm

909-6918 Black Recycled, Size 4, 132 x 205 x 350mm

909-6921 Black Recycled, Size 6, 182 x 420 x 375mm

Polypropylene (PP) Plastic Euro Containers

- Euro container (standardised European size)
- Additive prevents the growth of bacteria by up to 99.99%
- White
- No-lid
- Polypropylene (PP) plastic



178-3343 132 mm x 350 mm x 205 mm, 9.1 L

178-3344 132 mm x 240 mm x 150 mm, 4.6 L

178-3340 31.4 L, 200 mm x 520 mm x 310 mm

178-3341 28.3 L, 182 mm x 375 mm x 420 mm

178-3342 182 mm x 350 mm x 205 mm, 12.8 L

178-3320 75 mm x 165 mm x 100 mm, 1.27 L

Shelf Bin & Dividers

- Professional range of storage bins
- Ideal for use in any environment
- Can be used as a drawer, stacked and placed on a shelf
- Seamless, waterproof and corrosion resistant



775-5287 500 x 234 x 140 mm

775-5296 500 x 234 x 90 mm

775-5299 500 x 117 x 90 mm

Semi-Open Fronted Corrugated Fibreboard Storage Bins

- High quality, lightweight fibreboard
- Low cut bin front for easy access to contents
- Supplied flat for saving storage space prior to use
- Supplied in boxes of 25 bins



228-1239 400x200x100mm

228-1065 150x100x100mm

228-1100 200x100x75mm

228-1166 300x100x75mm

228-1122 200x150x100mm

228-1188 300x150x100mm

228-1116 200x100x100mm

228-1217 400x100x100mm

228-1251 450x100x100mm

PP Attached Lid Container

- Attached lid
- Stacks when the lid is closed or nests when it's open so you'll make more efficient use of your storage space
- Holder slot for a card or label allows you to identify contents quickly and easily.



178-3350 Green, 77L, 600 x 400 x 400
178-3359 Blue, 56L, 600 x 400 x 310

Polypropylene Euro Container

- Lightweight but strong construction
- Lid available separately
- Design makes them stackable
- Can be nested to save space when not in use
- Excellent box for storage and transporting
- Euro Containers – boxes and crates that are designed to fit on Standard European Size pallets
- Lid sold separately



163-1907 76L Grey, 400 x 400 x 600mm
725-9170 52L Grey, 600 x 400 x 270mm
725-9161 40L Grey, 200 x 400 x 600mm
725-9167 27L Grey, 600 x 400 x 150mm
725-9151 20L Grey, 400 x 300 x 220mm
163-1899 15L Grey, 170 x 300 x 400mm
725-9158 10L Grey, 120 x 300 x 400mm
725-9155 Lid for 600 x 400mm Euro Container
725-9164 Lid for 400 x 300mm Euro Container

Heavy Duty Unbreakable Storage Box with Lid

- Interlocking lid
- Stores contents safely
- Manufactured from heavy duty and shock resistant plastic



838-6551 60L

Transparent Compartment Boxes

- Transparent colour
- Polypropylene (PP) material



124-6592 60 mm x 240 mm x 170 mm
124-6589 30 mm x 170 mm x 100 mm

Polypropylene Component Case Storage Box

- Sturdy Polypropylene component case with transparent shockproof lid.
- For small component storage
- Removable inserts with individual lids
- Side locks for secure transport
- Carry handle



767-4973 21 Inserts
767-4964 16 Inserts
767-4960 10 Inserts

Transparent Compartment Box

- Transparent colour
- Polypropylene (PP) material



435-0220 9 Cell, 38 mm x 245 mm x 143 mm
435-0214 5 Cell, 40 mm x 181 mm x 125 mm
435-0208 10 Cell, 50 mm x 338 mm x 153 mm

Assortment Case

- Plastic compartment box for small component storage
- Transparent lids – easily view what is inside the box
- Slide locks for secure transport
- Ideal for workshops and garages

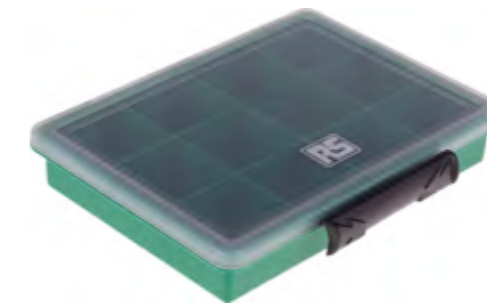

515-552 7 Compartments, 32 mm x 175 mm x 143 mm, Red
515-574 9 Compartments, 43 mm x 240 mm x 195 mm, Red
515-568 12 Compartments, 32 mm x 175 mm x 143 mm, Green
515-603 32 Compartments 57 mm x 338 mm x 260 mm, Green

Plastic Compartment Box with Adjustable Dividers

- Secure double lock
- Tough transparent lid with anti-migration bars to ensure small parts stay in place
- Integrated ergonomic handle
- 17 compartments - with movable dividers



435-0179 395 x 305 x 60mm

Slide-locking Box

- Strong hinges, sliding locks
- Ideal for the storage of nuts, washers, screws and small component parts



784-6058 12 Compartments

Plastic Storage & Shelving Unit

- Ideal solution to store small items and objects
- Lightweight, removable drawers
- Can be used as a free standing unit or mounted on the wall
- Manufactured from durable polypropylene



877-6803 30 Drawer
877-6812 40 Drawer

Tilt Storage & Shelving Unit

- Ideal solution to store small items and objects
- Lightweight, removable drawers
- Can be used as a free standing unit or mounted on the wall
- Manufactured from durable polypropylene



519-302 5 Drawer
519-295 6 Drawer
519-289 9 Drawer

Tilt Storage & Shelving Unit

- Ideal solution to store small items and objects
- Lightweight, removable drawers
- Can be used as a free standing unit or mounted on the wall
- Manufactured from durable polypropylene



909-6990 8 Drawer
909-7006 16 Drawer
909-7000 20 Drawer

Plastic Storage & Shelving Unit

- Dovetail slots to lock together with other cabinets
- Case made of high-density plastic
- Drawers made of polypropylene
- Black outer, translucent drawers



236-3628 2 Drawer
236-3612 4 Drawer
236-3606 8 Drawer

Drawer Unit

- Stackable, wall mountable small parts storage
- Dividable drawers with drawer stops
- Supplied with dividers and ID labels



178-3331 15 Drawer Cabinet
178-3368 36 Drawer Cabinet

Personal Storage Storage & Shelving

- Durable for factories, hospitals, colleges
- Modular design for tailored storage
- Reinforced doors with welded hinges
- Impact protection with welded channels
- Secure with in-frame lock, less than 2mm gap
- Lock plate cover for numbering or names



833-2939 3 Tier Locker, Grey Carcass, Red Doors
833-2914 3 Tier Locker, Grey Carcass, Grey Doors
833-2920 3 Tier Locker, Grey Carcass, Blue Doors
833-2945 5 Tier Locker, Grey Carcass, Red Doors
833-2923 5 Tier Locker, Grey Carcass, Grey Doors
833-2932 5 Tier Locker, Grey Carcass, Blue Doors
833-2926 6 Tier Locker, Grey Carcass, Grey Doors

Eco-Rax Shelving System

- Shelves constructed from chipboard
- Blue-coloured uprights constructed from corrosion-resistant, epoxy-coated galvanised steel
- Load capacity of 265 kg
- Quick knock-down system
- Conforms to ANSI/ESD S20.20:2014 and BS EN 61340-5-1:2007 Electrostatic Control Standards



813-3228 5 Shelves, 4 Uprights, 1.8m x 900mm x 600mm

Vented Mild Steel Blue Locker

- Mild steel material
- Has a standard three-pin socket in each compartment so you can charge your tools in a secure location.
- Coated with BioCote® microbial powder to reduce the levels of harmful bacteria on contact surfaces.



113-4499 6 Door
113-4501 8 Door

Wall Mounting Shelving - Bracket

- Versatile modular wall-mounted steel shelving system
- Epoxy powder-coated steel for moisture and chemical resistance
- Quick and easy assembly, adjustable for changing storage needs
- 4 solid shelves for sturdiness, extendable if necessary
- Adjustable shelving in 30mm increments, suitable for various uses



230-239 270mm
230-223 220mm
231-428 320mm
231-434 370mm

Wall Mounting Shelf

- Modular steel shelving system for workshop, garage, or home
- Epoxy powder-coated steel for moisture and chemical resistance
- Quick assembly, adjustable for changing storage needs
- 4 solid shelves, extendable; adjustable in 30mm increments



230-201 Upright, 1m
231-456 1m x 370mm
231-440 1m x 320mm
230-251 1m x 270 mm
230-245 1m x 220mm

Plastic Folding Flatbed Trolley

- Handy to store in vans and in the boot of cars
- Plastic platform with integral handles
- Castors fold underneath platform for compact storage
- Comfort handle for extra grip when manoeuvring
- Three adjustable (Telescopic) handle heights



909-7031 920 x 680 x 410mm, 120kg Capacity

Plastic Folding Trolley

- Lightweight, made from plastic, easy to use and move around
- Deep sided – depth 380 mm when opened
- Telescopic aluminium pull handle – on one side
- Fixed plastic wheels / castors
- Folds flat when not in use



669-3683 405 x 380mm, 35kg Load

Storage Cases

- Moulded in polypropylene with integral carrying handle
- Hinged lids and fastening catches
- Hard wearing, high resistance to damage
- Supplied with two nylon-covered foam inserts



556-777 220 x 160 x 40 mm

Foam Insert

- Designed for use with RS PRO ABS stackable boxes and compartment boxes.
- Medium density PU (Polyurethane) foam ensures great protection
- Safe handling and less noise



136-8892 Black, 390 x 290 x 16mm

Stainless Steel Carrying Handle

- Spring-loaded Fold Down
- Lie flat polythene grip handle



750-272 Large, 46 x 125mm Plate

750-294 Small, 38 x 96.5mm Plate

Steel Carry Handle

- Carrying handle
- No flush mounting
- Fold-down design
- Chrome-plated steel handle material



237-479 120mm

237-637 100mm

Plastic Carry Handle

- Non flush-mounting
- Non fold-down
- Non spring-loaded
- Plastic handle material



136-3418 24 mm x 158 mm

Suction Lifters

- Industrial quality for handling glass panes, synthetic panels, coated wooden panels, sheet metal, marble and ceramics etc.
- Bodies manufactured from impact resistant plastic and the triple cup model has a cast aluminium body



285-355 Double Two Cup, 115 mm cup, 80 kg

Round Lifting Slings

- Round slings for various lifting applications
- Strong, flexible & lightweight
- Polyester construction
- Lighter than chain & less likely to cause damage
- Easy to inspect for damage
- Shock absorbing
- High resistance to abrasion



124-4876 6m length

Clawhook Ratchet Strap

- High abrasion resistance
- Lashings manufactured from polyester
- Claw hooks and buckles included
- 50 mm width



729-3013 9m, Blue, 50mm Wide, 5000kg Breaking Strain

Zinc Plated Eye Nuts

- Suitable for a wide variety of applications such as tensioning wires, securing loads and lifting applications



124-4840 M8 36 mm Dia. 140 kg load

124-4842 M12 54 mm Dia. 340 kg load

124-4841 M10 45 mm Dia. 230 kg load

Eyebolts

- A range of high quality, metric eyebolts with collar
- BS4278 for use in a wide range of lifting applications
- Proof tested and supplied complete with test certificate
- Carbon steel



673-664 M20

673-658 M16

673-642 M12

673-692 M10

Zinc Plated Steel Bow Shackles

- Galvanised alloy steel shackles with screw pin.



674-083 1 ton Load, 9.65mm Shackle Dia.

Stainless Wire Rope Grips

- Quality stainless wire rope grips to DIN1141



247-9076 6 mm Wire Rope Dia.

183-5908 5 mm Wire Rope Dia.

183-5891 3 mm Wire Rope Dia.

Carbon Steel Rope Clamp

- Carbon steel U-bolt
- Steel bridge material
- DIN 741 specification
- Wire rope Dia. of 5 mm



124-4801 6mm wire Rope Dia.

124-4800 5mm wire Rope Dia.

Stainless and galvanised 'D' Shackles

- Stainless steel shackles with screw pin, for securing loads or plant



312-3516 10 mm Dia. 250Kg

FACILITIES CLEANING & MAINTENANCE

RS PRO offers cleaning products such as cleaning chemicals, brooms, mops, and maintenance equipment like vacuum cleaners and pressure washers.

Trigger Spray Pump Dispenser

- Trigger is adjustable so as to obtain a steady stream or spray
- Bottle is graduated to indicate content level
- Re-usable, refillable dispenser - eco-friendly
- Very simple to use
- Suitable for water based and non-aggressive solvents



779-318 600 ml

Spray Dispenser

- 750 ml industrial spray dispenser
- For use with penetrating or degreasing fluids



400-1007 750ml

Light Duty Cleaning Cloths

- Five wipes per pack
- Comes as a box
- Designed for repeated use
- 50 of Wipes per Pack



176-3664 Blue, 42 x 38 cm Wiper Size

176-3662 Red, 42 x 38cm Wiper Size

Litter Picker

- Grooved jaws with strong grip for removal of stubborn refuse
- Excellent ergonomic design allows the user to rotate jaws in 4 x 90° positions relative to the pistol grip
- Trigger handle with excellent grip and comfort
- Rotatable head



539-359 Aluminium, 850mm

Mops and Mop Handles

- Range of handles compatible with any screw fitments mop heads or brush heads, making them ideal for high standards of cleaning and maintenance
- Colour-coded to adhere to Health and Safety regulations



218-6718 Mop Handle, Blue, 1.4m

218-7727 Mop Handle, Red, 1.4m

218-6825 Yarn Mop Head, Blue

239-8589 Yarn Mop Head, Green

218-6803 Yarn Mop Head, Red

239-8573 Yarn Mop Head, Yellow

Dustpan & Brush

- Soft bristles sweep up light dirt and debris with ease
- The rubber lip of the dustpan assists with the collection of dirt
- Hanging hook for easy storage when not in use

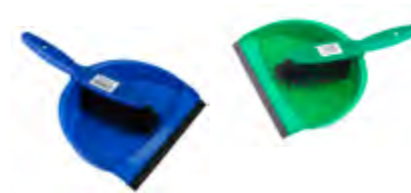

560-791 Blue

898-8210 Green

898-8214 Yellow

Heavy Duty Bin Bags

- Plastic disposal bag
- High tensile strength 40 mu Tri-ex blend film
- Packs of 50



771-6572 Black, 80 x 90L Capacity, 50 per Package

771-6563 Black, 90L, 50 per package

771-6569 Yellow, 110 L Capacity, 50 per Package

Plastic Flip Top Bin

- Durable plastic design that's easy to clean and maintain
- Flip lid for easy access
- Lightweight and portable
- Can be used for a range of waste needs
- Waterproof



178-7697 Blue, 50L

178-7698 Green, 50L

178-7699 Red, 50L

178-7702 Yellow, 50L

Vacuum Oil & Fluid Extractor

- Plastic oil extractor vacuum pumps
- Two suction probes measuring 6 mm and 10 mm in Dia.
- Suction probes measure 2100 mm in length
- Also supplied with a brake/clutch bleeding hose



Plastic Syphon Pump

- Hand-operated syphon pump that is easy to fit and use
- Made from durable plastic
- Capacity of 60 L to 205 L
- Draining speed of 17 L per minute
- Suitable for oils and non-aggressive chemicals
- Self-priming feature



851-7559 205L

851-7556 60 > 205L

851-7509 9L

Oil Container with Lid & Spout

- Professional and easy to use pump
- Allowing top ups on difficult to reach points
- 1 litre capacity



Precision Oiler

- Accurately lubricate a wide range of small components
- Operated with just one hand and controlled with a thumb plunger.



667-3480 5 mL

851-7553 1L

Lever Action Pump

- Professional and handy self-priming pump
- 330 ml per stroke
- Fitted with anti-drip nozzle
- 2 in. BSP connector and dip-tube to suit 100 or 205 litre drums
- Suitable for oils, antifreeze, paraffin and other non-corrosive fluids



Rotary Drum Pump

- Constructed from heavy duty steel
- Cast steel body with machined bore and rotor
- Supplied with 2" BSP adaptor and suitable for use on 205 litre drums
- Delivers approximately 0.2 litre/revolution



851-7547 0.2L

851-7562 100 > 205L

851-7503 Red, 5L

Oil & Fluid Drain Pan

- Heavy duty pan
- Suitable for parts cleaning operations with emulsifiable solvents
- Made from high-density polyethylene with UV stabiliser
- Heavy-wall construction stays rigid, even with hot oil
- Excess capacity helps prevent overflow or spillage
- Resistant to most chemicals and solvents



851-7600 8L

Metal Oil Cans

- High quality, strong deep drawn metal bodied
- Nylon pump units and metal spouts
- Complete with a 250 mm flexible braided interchangeable spout



672-122 Green

HDPE Oil Can

- The dispenser's body is made from high-density polyethylene (HDPE) which is extremely strong and won't crack when exposed to high temperatures.
- Resistant to chemicals so it won't corrode, even when constantly full of oil.



801-0746 0.35L

Steel Oil Can

- Suitable for dispensing oil and other non-corrosive fluids
- Made of zinc-plated steel
- Features hinged cover
- Retained dispensing cap attached with chain
- Comes with carrying handle



400-1035 5L

Plastic Fuel Can

- Plastic fuel cans
- EN and EU approved
- Colour coded for easy identification of their contents
- Feature a safety screw lock cap and a flexible pouring spout



851-7512 Black, 10L

HDPE Fuel Cans

- Flexible spout stored inside jerry can
- Spout with integrated ventilation
- Cover cap is secured against loss with flexible band
- Robust and resistant against impact
- Suitable for liquid fuels



703-1098 10L

703-1092 20L

703-1095 5L

Polythene Oil Cans

- Durable oil cans manufactured from high density polyethylene with nylon pump units.
- Supplied complete with two 6in. spouts, 1 flexible and 1 rigid.



674-336 0.35L

674-342 0.5L

672-138 Red, 0.5L

OFFICE & WAREHOUSE SUPPLIES

RS PRO offers office supplies such as pens, paper, file folders, desk organisers, and printer cartridges.

Self Adhesive Labels

- Vinyl cloth material
- Indoor use only



445-3880	Numbers, Black Text/Yellow Background, 9.5mm , 10 pack
514-846	Numbers & Symbols, Black Text, 50mm, Pack of 56
445-3903	Numbers, Black Text/Yellow Background, 15.9mm , Pack of 10
456-6740	Numbers, Black Text/Yellow Background, 100mm
514-830	Numbers & Symbols, Black Text/White Background, 30mm, Pack of 56
514-802	Letters, Black Text/White Background, 30mm, Pack of 50
456-6712	Letters, Black Text, 100mm, Pack of 50
400-0802	Numbers, Red Text/White Background, 50mm, Pack of 56
514-852	Numeric Label, Black Text/White Background, 75mm, Pack of 56
514-818	Alphabetic, Black Text/White Background, 50mm, Pack of 50

Brass Stencils

- Brass material
- Contains letters and numbers



609-332	25mm Character height, 105 Pieces
---------	-----------------------------------

Self Adhesive Printed Vinyl Cloth Labels

- Adhesive labels: 38 mm length, 15 mm width
- Very soft with excellent adhesion on cable and curved substrates
- Temperature range: -30°C to +100°C
- Resistant to mild acids, alkalis, oils, greases, solvents
- Packaging: 152 sticker sheets per pack

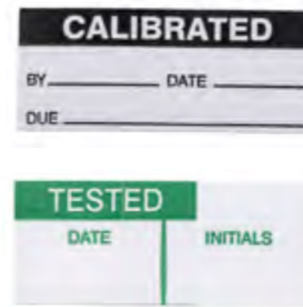

758-7999	Accepted – Green and White
758-8005	Calibrated – Black and White
758-8018	Tested – Green and White
758-7955	QA Approved – Green and White
758-7967	QA Inspected – Green and White
758-7989	Tested for Electrical Safety – Green and White
758-7970	Checked – Green and White
758-7949	Date Installed – Green and White
758-7977	Inspected By – Black and White
758-8002	Serial No. – Black and White

Preprinted Label

- Adhesive labels: 38 mm length, 15 mm width
- Very soft with excellent adhesion on cable and curved substrates
- Temperature range: -30°C to +100°C
- Resistant to mild acids, alkalis, oils, greases, solvents
- Packaging: 152 sticker sheets per pack



146-8972	Calibration Not Required - Black and White
758-7905	Tested For Electrical Safety - Green and White
758-7923	Calibrated - Green and White
758-7901	Tested - Green and White
758-7908	Next Test Due - Green and White

Harmony Executive Mesh Office Chair

- Ergonomic design for ultimate comfort and posture
- Breathable mesh seat and backrest
- Durable five star chrome base with wheels
- Gas lift seat for adjustable height



180-9716 Mesh, Black

Wheeled Chair

- Medium-sized office chair with easy assembly
- Sturdy base with wheels for maneuverability
- Backrest with height adjustment and hinged tilt, supports up to 90 kg



197-0404	Fabric, Blue
197-0402	Fabric, Blue, With Arms
221-6329	PU leather, Black
180-9725	Fabric, Black

Executive Office Chair

- Stylish and supportive
- Flip-up armrests
- Reclining function with tilt tension
- Matching visitor chair available
- Fully synchronising mechanism with weight tension control
- Requires easy self-assembly
- Reclining function with tilt tension



228-0369 Black

Conference Chair

- Utility seating for varied use, reception, conference etc.
- Stacks for easy space saving storage
- Available from stock in black & blue
- Fully assembled with optional arms available.



197-0397	Blue
180-9722	Black

Suction Cup Hooks

- Plain finish
- PVC material
- A2 304 stainless steel type
- Suction cup Dia. of 20 mm



397-4897 20 mm, Pack of 10

Desk Mounting Monitor Arm

- Improves posture when sitting at your desk
- Flexible
- Frees up desk space
- Can adjust arms individually
- C-Clamp for mounting onto your desk



141-8310	2 Screen
176-3376	1 Screen

Wall-Mounted LCD Monitor Bracket 3

- Wall Mount Kit



176-3381 Black

Strapping Kit

- Breaking strain of 185 kg
- Suitable for securing heavier duty goods in factories, workshops or industrial settings
- Handy all-in-one solution, the kit includes a dispenser, a 12 mm tensioner, a 12 mm sealer, 500 seals and a coil of black polypropylene strapping with a width of 12 mm.



912-9147 Black, 185 kg, 1500 m

Banding Tool

- Tensioner and cutter
- Lightweight and easy-to-use



183-5790 15mm Wide
912-9096 19 mm Wide

Mobile Dispenser

- Ideal for transporting polyester strapping
- Handy storage tray for storing necessary strapping tools and buckles together
- Welded tubular steel
- Blue powder coat
- Dispenser with wheels



912-9093 1000 x 390 x 400mm

Hand Pallet Wrap & Dispenser

- Lightweight plastic construction



912-9214 400mm roll
183-947 500mm roll

Pallet Wrap

- Transparent LLDPE
- Stretch Wrap
- Durable
- Install by hand or machine
- Excellent stretch properties



240-1177 400mm x 300m, Box of 4 Rolls
240-1178 500mm x 300m, Box of 4 Rolls

Pallet Wrap Set

- Set includes 1 reusable dispensing handle and 10 rolls with length of 100m
- Made from recyclable linear low-density polyethylene (LLDPE)
- Easy to apply and remove



329-5920 100 mm x 100 m

Hand Strapping

- Polypropylene



912-9188 Black, Reel

Plastic Strap and Buckle Kit

- Strapping material made from polypropylene
- Buckles made from plastic
- Kit includes 200 buckles
- Box has a dispenser at one end and a drawer containing buckles at the other



211-7677 Black, 800 m, 200 Buckles

Galvanised Metal Strap and Seal Kit

- Hand strapping starter kit comprising a reel of polypropylene strapping and metal seals.
- PP (polypropylene) strapping material
- For easy storage and use, the kit comes in a dispenser.
- Breaking Strain: 101kg



673-080 Black, 800 m x 12mm

White Address Label

- Self-adhesive fixing type
- Anti-tamper label
- Conforms to international ANSI/ESD S20.20:2014 and European BS EN 61340-5-1:2007 standards for electrostatic safety



450-5919 38 mm x 11 mm, Pack of 200

White Label

- White background colour
- Tie fixing type
- Hard polyvinyl chloride (PVC) material
- Nylon tie material
- Complies with ANSI/ESD S20.20:2014 and BS EN 61340-5-1:2007 electrostatic control standards



792-4499 145 mm x 75 mm, One label

Hotmelt Cord Polyester Strap

- Hot-melt cord polyester mono-filament strapping
- Lightweight and flexible
- Weather and U.V. Resistant
- Shock Absorbent
- 330kg Breaking Strain



912-9107 78mm core, 1100m x 15mm

Polyester Strapping

- Breaking strain of 412 kg
- Conforms to the ANSI/ESD S20.20:2014 and BS EN 61340-5-1:2007 Electrostatic Control Standards



912-9181 White, 1100m x 15mm

Packaging Plastic Coated Wire

- Steel, plastic coated



397-4819 50 m

Bag Stapler & Staples

- A handheld, plier action stapler of all steel construction with a durable chrome finish and easy to load mechanism
- Designed for reaching into hard to get at places and for use with tough materials
- Ideal for use in stores, workshops and many other heavy production areas

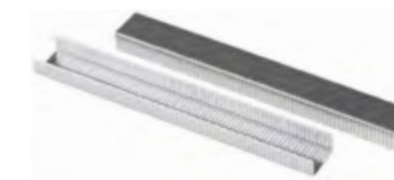

183-7279 Stapler
183-9326 6mm Staples

Horn Speaker

- IP66 rating: dust-tight, withstands powerful water jets
- For indoor and outdoor use

**IP66
RATED**

General Purpose Coloured Speech/Music Microphones

- General-purpose microphones ideal for singing, speech, or narration
- Low sensitivity for enhanced handling and control
- Unidirectional pick-up pattern
- Internal rubber shock isolation system
- Built-in on/off switch



535-0300 15 W, Metal, IP66, 280 Hz to 12.5 kHz
535-0243 30 W, ABS, IP66, 250 Hz to 16 kHz, Beige



352-2698 500 OHM

Analogue Wall Clocks

- 31cm dia. red metal case
- Quality low noise quartz movement
- Shatterproof front lens
- R6 battery supplied



248-6688 Silver, 310mm Dia.
248-6685 Blue, 310mm Dia.
248-6687 Black, 310mm Dia.
248-6684 Red, 310mm Dia.

Metal Cased Wall Clock

- White dial with 12 hour markings and minute track printed in black
- Shatterproof front lens
- Fitted with a quartz battery movement
- AA battery supplied



366-3137 White, 300mm Dia.

Digital Pocket Stopwatch

- Black water and shock resistant plastic case, making it ideal for use in a range of applications
- Clear big digits with LCD screen to display results with ease
- Large 12.4 mm and 10.8 mm digit heights
- Normal time, calendar, and alarm facility
- Accuracy within 2 second over 24 hours
- 5-year battery life under normal use
- Supplied with a handy cord lanyard



241-3114 Black

Digital Pocket Stopwatch

- Stylish black water-resistant plastic case
- Clear LCD screen with large 12mm and 10mm digit heights
- Features normal time, calendar, alarm, and lap facility
- Accuracy within 2 seconds over 24 hours
- 5-year battery life under normal use
- 1/100 second resolution
- Counts up to 40 minutes in 1/100 second, then to 24 hours in 1-second intervals



811-1814 24h

Quartz LCD Calendar Clock

- For wall and desk
- Display showing Hours and Minutes, Calendar and Temperature
- Switchable between 12/24 hours and C/F degrees
- Operates using 2 x R6 batteries that are supplied



811-1820 Silver, 220x250x23 mm

Digital Desktop Timer With Jumbo Display

- An LCD timer that counts up and down to/from 99 minutes, 59 seconds with alarm at the end of the count down period. Jumbo display 27 and 20mm digit height; case with back clip, stand, magnet and hook.



557-610 99 min 59 s

Water resistant Quartz Wall Clock

- The viewing distance during a day is up to 25 metres
- The Clock is fully sealed with rubber gaskets from and back
- The humidity tolerance level for this Analogue is reasonable, but this is NOT for sauna use



706-4773 300mm Dia.

Wall Clock with Silent Operation

- Fitted with a quartz movement and continuously moving second hand for silent operation



440-9568 300mm Dia., AA battery
248-6683 White, 420mm Dia., LR6 alkaline battery

ABS Wall Analogue Wall Clock

- White plastic cased wall RS branded clock, with shatterproof front lens
- White dial with 12 and 24 hour markings and minute track printed in black and red
- Fitted with a quartz battery movement
- 1 x AA size battery supplied



706-4789 21.5cm Dia., Viewing distance up to 20 metres
706-4786 30cm Dia., Viewing distance up to 30 metres

Desktop Timer With Count Up Timer

- Lap facility function
- Clock, calendar and alarm
- Incorporates a count up timer feature, allowing you to also measure time elapsed.
- The user friendly interface includes 3 buttons for start/stop, mode and split/lap/reset that are colour coded and easy to use.



365-6230 White

Stopwatch With External Switching Sockets

- Time is measured using a 1/100 second count up facility to 10 hours with lap and split options, including an accuracy within 0.5 second over a 10 hour period.
- Three sockets for external switching - start, stop and reset
- Dual mode: lap and split
- Restart without reset, timing pause function



235-5059

Combination Clock, Timer and Stopwatch

- Light weight clock device is ideal for a wide variety of applications such as laboratories benchtop, schools and desks.
- Stopwatch, timer, 12/24h clock, lap facility on count up, alarm calendar



440-9805 Silver, 90 x 160 x 70 mm

ADHESIVES, SEALANTS & TAPES

RS PRO provides products like adhesive tapes, sealants, epoxy resins, and industrial adhesives.

Sealant Applicator Gun

- A manual sealant gun for use with adhesive and sealant cartridges up to 400ml.
- Supported cartridge volumes: 305 / 310 / 380 / 400 ml
- Supported cartridge dimensions: 260mm (length) x 50mm (diameter)



174-791 Applicator Gun for 305 / 310 / 380 / 400 ml Cartridges

Duct Tape

- Adhesion strength of 3.5 Newton centimetres (N/cm) to 5.5 N/cm
- Adhesive material made from rubber resin
- Fabric backing material
- Elongation at break of 0.24
- Gloss finish
- Thickness of 0.23 mm
- Maximum operating temperature of +80°C
- Minimum operating temperature of -50°C
- Tensile strength of 32 Newton centimetres (N/cm)



- 146-7415** Yellow, 50mm x 50m, Gloss Finish
- 146-7416** Silver, 50mm x 50m, Gloss Finish
- 146-7418** Red, 50mm x 50m, Gloss Finish
- 146-7419** Blue, 50mm x 50m, Gloss Finish
- 146-7414** Black, 50mm x 50m, Gloss Finish
- 176-9808** White, 25 m x 50 mm, Matt

Squeeze Bottle

- Squeeze bottle for use with cleaner, oil, solvent and other liquids
- Made from polypropylene (PP)
- Can release single drops or fine streams



548-4289 Translucent, 225mL Bottle
548-0962 Translucent, 110 ml Bottle

Squeeze Bottle

- Spill-proof squeeze bottle
- Made from polyethylene material
- 25 mm stainless steel needle for precise liquid distribution
- Suitable for use with oil and solvent



547-4226 Translucent, 60mL Bottle, 25 mm stainless steel needle

Bench Tape Dispensers

- Robust all metal bench tape dispenser
- Can be used with 1 to 3 rolls - model dependant
- Wall mounted, bench mounted or free standing



912-9068 1 x 50 mm, 2 x 25 mm Width Tape

PVC Insulating Tapes

- Available in a range of colours, widths and lengths. Examples shown 19mm width, 33m length



- 134-7326** Yellow 33 m x 19 mm
- 134-7332** Yellow 20 m x 12 mm
- 134-7335** White 20 m x 38 mm
- 134-7320** White, 33 m x 19 mm
- 134-7333** White 20 m x 12 mm
- 134-7323** Red 33 m x 19 mm
- 134-7327** Red 20 m x 12 mm
- 134-7328** Green/Yellow 33 m x 19 mm
- 134-7325** Green/Yellow 20 m x 12 mm
- 134-7331** Green 33 m x 19 mm
- 134-7334** Green 20 m x 12 mm
- 134-7324** Blue 33 m x 19 mm
- 134-7330** Blue 20 m x 12 mm
- 134-7329** Black 20 m x 38 mm
- 134-7319** Black 33 m x 19 mm
- 134-7321** Black 20 m x 12 mm

Double Sided PVC Tape

- Designed for high adhesion, heavy-duty applications, offering secure and long-lasting attachment to surfaces for complete peace of mind
- PVC film coated tape with an aggressive clear acrylic adhesive, which is then interleaved with a release liner for fuss-free use
- Strong adhesive properties that make it resistant to high temperatures, U.V and difficult substrates



- 223-1090** Yellow, 38 mm x 50m
- 223-1083** Yellow, 19mm x 50m, 0.245mm Thick
- 223-1077** Yellow, 12 mm x 50m, 0.245mm Thick

Double Sided Paper Tape

- Easy to tear and flexible, allowing for minimal application and installation time, especially when working with irregular or round surfaces
- Paper coated tape with an aggressive specially constructed adhesive, which is then interleaved with a release liner for fuss-free use
- RoHS compliant



- 223-1093** White, 50mm x 50m, 0.1mm Thick
- 223-1087** White, 25mm x 50m, 0.1mm Thick
- 223-1080** White, 19mm x 50m, 0.1mm Thick
- 125-4306** White, 9 mm x 50 m
- 125-4304** White, 25 mm x 50 m
- 125-4303** White, 15 mm x 50 m
- 125-4302** White, 12 mm x 50 m
- 223-1094** Yellow, 50 mm x 50m

Self Amalgamating Tapes

- Easy unwind & extremely flexible
- Resistant to water, ozone and UV
- Excellent low and high temperature performance as well as excellent conformability to awkward shapes
- Breaking load is 20.0N/cm and elongation is 600%

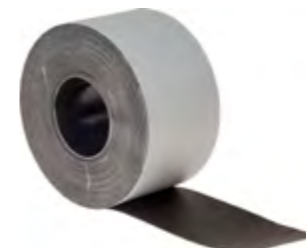

- 146-8999** Black, 50mm x 10m
- 146-8998** Black, 25mm x 10m
- 146-9000** Black, 19mm x 10m

PTFE Extra Thick PTFE Tape

- Extra thick PTFE tape designed for sealing threads in just one wrap
- Only requires 50% overlap on the thread for BS21 thread up to 2 inches.
- Suitable for more aggressive environments where acids, gases or solvents may be present
- Easy to apply and handle
- Robust pressure resistant



- 231-964** White, 12mm x 5m, 0.2mm Thick
- 183-3490** White, 12 mm x 12 m x 0.075 mm

Clear PP Double Sided Tape

- Flame retardant
- PP film coated tape with thin gauge polycarbonate film with polished surfaces on each side
- Easy to tear and flexible, allowing for minimal application and installation time, especially when working with irregular or round surfaces



- 223-1085** Clear, 38 mm x 50m
- 223-1092** Clear, 38 mm x 50m

Foam Tapes

- Low density PVC foam sealing strips
- Closed cell construction gives a positive seal at only 30% compression
- Seal cabinets, enclosures and machines against light, dust, moisture etc.



205-0912	Grey, 9mm x 30m, 3mm Thick
205-0805	Grey, 6mm x 30m, 3mm Thick
205-0940	Grey, 25mm x 15m, 6mm Thick
733-6797	Grey, 5 m x 20 mm x 6.4 mm
733-6785	Grey, 15mm x 5m, 3.2mm Thick
733-6781	Grey, 12mm x 5m, 2.4mm Thick
205-0833	Grey, 12mm x 30m, 3mm Thick
205-0928	Grey, 12mm x 30m, 3mm Thick
205-0883	Black, 25mm x 15m, 6mm Thick
205-0906	Black, 25mm x 10m, 10mm Thick
619-1786	Black, 20mm x 10m, 5mm Thick
619-1770	Black, 20mm x 10m, 3mm Thick
619-1764	Black, 15 m x 10 mm x 5 mm
619-1758	Black, 15mm x 10m, 3mm Thick
205-0861	Black, 12mm x 30m, 3mm Thick
205-0877	Black, 12mm x 15m, 6mm Thick
567-963	Black, 12mm x 10m, 3mm Thick
205-0899	Black, 12mm x 10m, 10mm Thick
619-1742	Black, 10mm x 10m, 5mm Thick
619-1720	Black, 10 m x 10 mm x 3 mm

Packing Tape & Hand Tape Dispenser

- Hand tape dispenser with ergonomic grip that fits comfortably in the user's hand, making tape application quick and effortless and reducing fatigue
- Polypropylene film coated with dispersion acrylic adhesive sold separately



263-3473	Hand Dispenser
263-3475	Dispenser Replacement Blade
176-9805	Packaging Tape, Clear, 48 mm x 66 m

Hook & Loop Tapes

- Options back-to-back continuous hook and velour loop plastic tape in black colour, has hook on one side with loop on the reverse for various usages and hook tape has rubber adhesive to provide an ultimate bonding with regular loop tape for higher strength
- applications that require minimal opening and closing.



890-4161	Hook, Adhesive Backed, Black, 20mm x 5m
890-4187	Hook & Loop, Black, 20mm x 10m

Floor Marking Tapes

- Ideal for use for most environments and applications as a universal indicator and identifier of potential hazards or warnings
- Designed with a plasticised PVC film coating to ensure optimum durability, performance and abrasion-resistance, especially in areas with high traffic or footfall

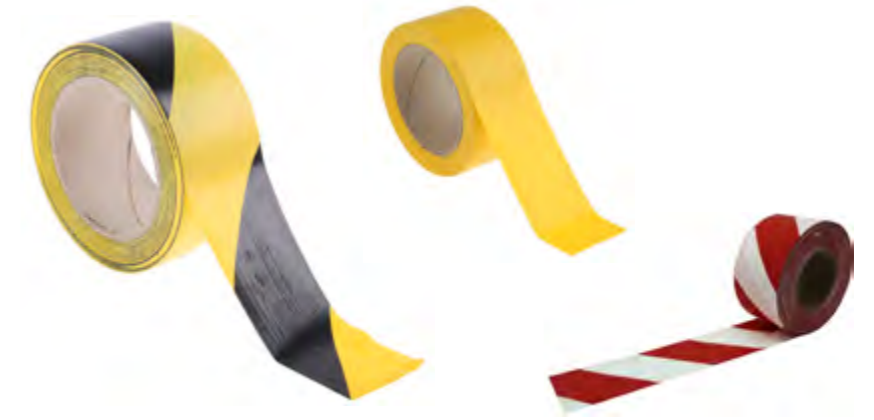

197-1012	Yellow/Black, 50mm x 33m
171-9692	Yellow, 50mm x 33m
125-2187	Red/White, 80mm x 500m
171-9700	Red/White, 50mm x 33m

Anti-Slip Tape

- Abrasive grit "anti-slip" products with self adhesive backing gives additional grip underfoot on smooth surfaces
- Hard wearing, easy to install on floors steps, ramps, machinery, vehicles and boats

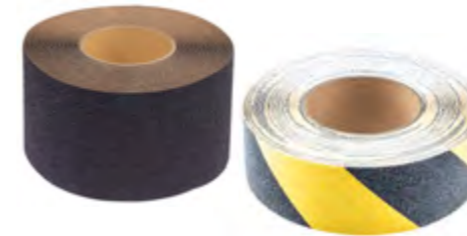

762-1525	Black/Yellow 50mm x 18.3m
762-1503	Black, 25mm x 18.3m
762-1506	Black, 50mm x 18.3m
762-1500	Black, 102mm x 18.3m
762-1519	Black, 152mm x 18.3m

Reflective tape

- Specially designed for application to plastic and rough substrates
- Should be applied at temperatures between 0°C and +25°C
- Recommended for use on flat surfaces

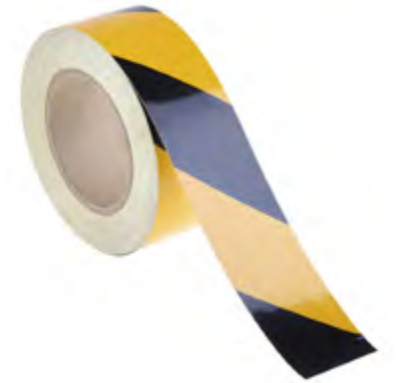

219-7897	Black/Yellow, 50mm x 25m
219-7881	Black/Yellow, 100mm x 25m

Masking Tape

- Rubber resin adhesive material
- Crepe paper backing material



171-9703	White, 25 mm x 50 m
184-6801	75mm x 50m
184-6809	75mm x 50m
184-6808	50mm x 50m
184-6806	38mm x 50m
184-6805	25mm x 50m
184-6803	12mm x 50m
184-6799	12mm x 50m
184-6802	100mm x 50m
184-6810	100mm x 50m
184-6800	38mm x 50m
184-6804	19mm x 50m

Aluminium Tape

- Breaking load is 12N/cm and elongation is 5%
- Operating temperature ranges between -20°C and 110°C
- Flame retardant and self-extinguishing
- Water-resistant Aggressive adhesive



146-8961	0.07mm, 50mm x 45m
----------	--------------------

Hook & Loop Cable Ties

- Die-cut cable ties feature hooks on one side and loops on the reverse making them the ideal solution to all your cable management applications
- Use to easily sort, tidy, bundle, hold or attach cables as required



890-4206	Black, 20mm x 200mm, Pack of 50
----------	---------------------------------

Safety and Hazard Warning Tapes

- One roll has sufficient length to designate a large area
- Made from non-adhesive durable polyethylene which prevents tearing
- Bold white characters on the red background is designed to attract attention and provide a warning message that is clear and visible



763-2049	Red/White, 70 mm x 100 mm
503-714	Red/White, 50 mm x 100 m
503-708	Yellow/Black, 50 mm x 100 m

PPE & SITE SAFETY

Discover RS PRO's site safety products, including safety helmets, safety glasses, high-visibility vests, and safety signs.

Hi-Vis Vest Waistcoat

- High visibility
- Reflective tape marking - increased visibility
- Contrast panels for dirt protection



- 141-8168 Yellow, S
- 141-8169 Yellow, M
- 141-8170 Yellow, L
- 141-8174 Yellow, XL
- 141-8176 Yellow, XXL
- 141-8177 Orange, S
- 141-8178 Orange, M
- 141-8179 Orange, L
- 141-8183 Orange, XL
- 141-8292 Orange, XXL

Kneeling and Sitting Mat

- High tear resistance due to the strong and durable exterior
- A multitude of small air bubbles are enclosed within the main body of the pad, offering a soft cushion, foam-like texture - this gives evenly distributed the user's body weight



154-867 24 x 44 x 3cm

Knee Pads

- Moulded from durable rubber.
- Highly protective, non-skid knee pads
- Excellent cushioning for knee joints
- Strong, fully adjustable webbing straps



154-829 Black, One Size

Bump Cap

- High-profile ABS shell acts as a shock absorber and comes with a soft padded crown, giving optimum safety and protection for the wearer
- Features a short peel of 3cm which allows for increased upward and better peripheral visibility
- Made from 100% cotton, ABS and EVA Foam



- 918-5674 Grey/Orange
- 918-5670 Black/Red

Head Protection Signage

- Various site signage available
- PVC construction



- 157-9305 Safety Helmets Must Be Worn - 400 mm x 300mm
- 763-1667 Warning Mind your Head - 210 mm x 148mm

Over Shoe Cover

- Deeply embossed with anti-slip soles
- Polyethylene fabric
- Not ESD safe
- Designed for use in cleanrooms, laboratories and pharmaceutical environments



829-5366 Blue, One size only, Box of 2000 pairs

Ear Defender Storage Box

- Manufactured from strong ABS plastic
- Top opening preventing dust and dirt from entering the box



325-6161 236 x 225 x 125mm

Cleanroom Disposable Labcoat

- Ideal white coat for engineering, medical and all lab work
- Lab coat meets ISO 5 cleanroom standards
- Unisex lab coat, suitable for both men and women
- Lab coat opens and closes with a zipper



- 829-5240 White, XL
- 829-5231 White, Large

Cuffed Beanie

- 100% Acrylic
- Soft touch
- Double layered knit
- Comfortable fit



137-0288 Black

Back Support Belt

- Designed to give excellent lower back support, which can help reduce back stress and potential injuries.
- Durable and lightweight
- Manufactured from nylon
- Hook and loop fastenings for easy adjustment
- The belt stretches for user comfort



656-7105 36 > 42in

Site Safety and Protection

Security is a key element in the site protection such as warehouses. Due to the interaction between pedestrians, vehicles and goods, there are many risks of accidents such as collisions or falling loads. It is essential to implement protection systems to avoid these risks.

To ensure the safety of people (staff or visitors) and infrastructure (machines, vehicles, racks, etc.), it is essential to identify risk areas and install safety devices to protect the work environment within the company. What protection solutions should be put in place to ensure personnel safety while protecting equipment?

STAFF:

Define traffic path to avoid trolley/pedestrian accidents.

- Security Barriers
- Safety Mirrors
- Plastic and Steel Posts
- Anti-slip Protections

EQUIPMENT & BUILDINGS:

Protect equipment from impact from forklifts and vehicles.

- Safety Barriers
- Steel Posts

RACKS AND DOCKS:

Protecting infrastructure and reducing risk in collisions.

- Safety Barriers
- Steel Posts

Electric Flash Symbol Sign

- Self-Adhesive Electrical
- Hazard Warning Sign



776-0945	Vinyl Label 150 mm x 150mm
813-4423	Vinyl Label 100 mm x 100mm
763-1632	Vinyl Label 200 mm x 200mm
776-0948	Vinyl Label 25 mm x 25mm, 250
776-0967	Vinyl Label 50 mm x 50mm, 250

Ramped Anti-Fatigue Mat

- Reduce and prevent hazards in the workplace & improve users performance by reducing fatigue by up to 50%
- Loose lay meaning that there is no need for adhesives and they can be moved to accommodate your needs
- Use on floors or to top work benches
- Use in wet and dry environments



221-7902	600mm x 0.9m x 16mm
----------	---------------------

Lockout Starter Kit

- Portable electrical department lockout tag out kit
- Provides all the basic Lockout for valves and electrical panels
- Comprises of around 24 different products
- Supplied in a tough LOTO caring bag (with handle and shoulder carrier)



862-5247

Lockout Hasp

- Plated to resist chemicals and rust
- Manufactured from high tensile steel
- Thick vinyl covered padlock section to resist wear
- Each lockout accepts up to 6 padlocks with up to 9.5mm shackle diameter
- Available in two sizes, 25mm or 38mm jaw diameter



489-141	25mm,6 lock
489-147	38mm,6 lock
805-5506	25mm,6 lock
805-5500	38mm,6 lock
818-8041	16 padlock lock out station

Warning Cones

- Class 1 reflective cone
- Made of polypropylene
- Two reflective stripes
- General use cone



503-681	30cm
503-754	50cm
503-691	75cm

15 Litre Spill Kits

- These lightweight kits are ideal for use on light to medium spills and leaks that could cause injury



771-6462	Chemical
771-6465	Maintenance
771-6468	Oil

Indoor/Outdoor Circular Mirror

- Weatherproof for indoor or outdoor use
- 90 degrees viewing
- Made from acrylic shell with anti-glare hood



663-4618	610mm Dia.
----------	------------

Standard Weight Absorbent Chemical Spill Pad

- Absorbent pads.
- Chemical spills.
- Industry recognised.
- Yellow colour – absorbs anything including aggressive chemicals.
- Absorbency 0.9 litres per sheet



771-6386	48 cm x 38 cm, 100 sheets pack absorbency of 90 litres.
771-6399	48 cm x 38 cm, 20 sheets pack absorbency of 18 litres

Safety Railings

- Corner and edge protectors are a quick and easy solution to protecting personnel and equipment in busy workplaces.
- Can be attached to surfaces providing protection for any collision with an angled edge.
- With a high visibility black and yellow design, these foam edge protectors are often resistant to acid, oil and grease and so are suitable for use in challenging environments.



724-9779	Gutter, EVA, 750mm (L), Ø 40mm
724-9794	90° Angle, NBR, 70x30x30, Ø 8mm, Supplied with double adhesive-backed tape.

Wall Mount Safety Barrier

- Safety barriers prevents movement and restricts access to a potentially dangerous or restricted area.
- Ideal for situations where you want a flexible retractable barrier without taking up any floor space.



829-9075	Wall Unit, Caution-Do Not Enter Webbing
----------	---

SECURITY & IRONMONGERY

RS PRO offers security products like padlocks, security cameras, access control systems, and ironmongery items such as hinges and door handles.

Electro holding magnets

- Typically used on machine mechanisms door / guard locking and remote hold / release requirements
- Basic plated steel discs
- Designed to complement the energise to release and energise to hold magnets



739-3255 40mm Dia

Replacement split ring packets

- Used to secure spare keys
- Priced each in a pack of 20
- Various sizes available



866-535 25mm OD

Key Weatherproof Padlock

- Pin tumbler structure for great pick resistance test
- Different sizes of lock body and shackle for different choices



781-6001 Brass, Blue, 6mm Shackle, 43mm Body
781-6013 Brass, Red, 6mm Shackle, 43mm Body

Key Weatherproof Padlock

- Great corrosion resistance
- Pin tumbler structure for great pick resistance test
- Different sizes of lock body and shackle for different choices



781-6007 Brass, 7mm Shackle, 50mm Body
781-5991 Brass, 6mm Shackle, 40mm Body
781-5997 Brass, 5mm Shackle, 30mm Body
781-5994 Brass, 4mm Shackle, 20mm Body
827-4417 Aluminium, 5mm Shackle, 27mm Body
827-4408 Aluminium, 4mm Shackle, 20mm Body
781-6004 6mm Shackle, 40mm Body
827-4414 Combination 7mm Shackle, 53mm Body
781-6026 Combination 7mm Shackle, 53mm Body

Weatherproof Combination Padlock

- 3/4 digit combination code
- Set your own combination freely for personalized convenience and increased security
- Brass lock body with excellent resistance for corrosion



781-6035 Brass, 5mm Shackle, 30mm Body
827-4423 Brass, 6mm Shackle, 40mm Body, 4 digit combination
781-6032 Brass, 3mm Shackle, 20mm Body, 3 digit combination
781-6039 Silver, 5mm Shackle, 30mm Body, 3 digit combination
781-6041 Red, 5mm Shackle, 30mm Body, 3 digit combination

Steel Hasp and Staple

- Pre-drilled holes so you can quickly fix it onto a panel, lid or door.
- You can easily secure it with a pin or standard padlock.



448-2327 254 x 54mm

Hasp and Staple, 316 Stainless Steel

- Available in 316 grade stainless steel and in two sizes
- Excellent anti-corrosive properties
- Ideal for use in food, chemical and other 'clean' industries
- Supplied complete with stainless steel fixing screws



434-9602 114 x 36mm
434-9595 90 x 36mm

Heavy Duty Hasp & Staple

- Ideal for general utility services
- Heavy duty style has a square hole on the hinge flap that permits the use of a 5/16 in. (8 mm) carriage bolt and prevents removal
- Mild steel with bright zinc plated finish



751-354 150 mm
751-332 153mm, 8mm

Cabinet Lock and Knob

- As it's plated with chrome, this cam lock won't rust or tarnish.
- Made of tough die-cast zinc alloy, so it's able to withstand daily use.
- For speedy installation, this lock is easy to fix into place using the supplied nut and bolt.



146-1810 Panel to Tongue Depth 13.5 mm, Cabinet Lock, Knob to Unlock

Die-Cast Zinc Cabinet Lock

- Made of die-cast zinc
- Panel to tongue depth of 20 mm
- Key unlocking method
- Key type- it only has 1 combination key. Key common.



192-9655 20 mm Panel to Tongue, Key Unlock

Silver Die Cast Triangular Lock

- Crafted from durable die-cast zinc with an IP54 rating, these cabinet locks are engineered to withstand the wear and tear from commercial and industrial environments, while offering superior performance and security, no matter what



192-9649 25mm Panel-to-Tongue, Key Unlock

IP54 RATED

Combination Aluminum Combination Padlock

- Aluminium body for increased weather durability and strength
- Resettable code



196-3972 Red, 6mm Shackle, 40mm Body, 4 digit combination
196-3969 5mm Shackle, 32mm Body, 3 digit combination
196-3967 Blue, 3mm Shackle, 23mm Body

IP54 Double Bit Cam Lock

- IP54 (Ingress Protection) rating, the lock is resistant to splashes of water from all directions and dust.
- Operating the lock requires a 90-degree turn, which means you're less likely to leave it accidentally unlocked.
- Double bit key available separately



192-9644 Die Cast Zinc, 26mm Panel-to-Tongue
192-9645 Stainless Steel, 13mm Panel-to-Tongue, Key Unlock
192-9646 Stainless Steel, 20mm Panel-to-Tongue
192-9648 Stainless Steel, 32mm Panel-to-Tongue

IP54 RATED

Toggle Latch

- Stainless Steel
- Polished Finish
- Adjustable



339-9218 75 x 26.5 x 16.5mm

Small Flexible Toggle Latch

- M3 Fixing
- Latch to catch 29.5 mm



665-9948 Stainless Steel 41 x 41 x 14mm

665-9945 Steel, Zinc plated, 41 x 41 x 14mm

Toggle Latch

- Steel & Stainless steel
- Catch plate only available



726-4150 Zinc Plated, 121 x 42mm

161-1955 23.5 x 11.4 x 74 mm, 28 x 13.5 x 48mm

Thermoplastic Hinge

- Matt Black finish
- Steel pin
- 6 mm countersunk fixing holes
- Resistant to greases, oils and most chemicals



702-7838 48mm x 48mm x 10.5mm

702-7831 64mm x 64mm x 13mm

Fibreglass Reinforced Butt Hinge

- Matte Black
- Glass reinforced nylon
- Countersunk fixing holes



770-3006 30 mm x 30 mm x 3 mm

Toggle Latch

- Steel & Stainless steel
- Catch plate only available



726-4169 Catch plate only

Lockable Latch

- Toggle latch type
- Lockable (lock not included)
- Made from stainless steel



436-9993 165 x 70 x 20mm

751-304 152 x 38 x 38mm

Steel Butt Hinge

- Steel
- Free-swinging
- Screw fixing



436-5070 75mm x 49mm x 1.4mm

Piano-style Hinge

- 304 Stainless Steel
- Spring close
- RoHS



726-4078 50mm x 50mm x 2mm

Stainless Steel Hinges

- 304 Stainless Steel
- Free swinging
- Riveted pin



749-1706 38 mm x 40 mm x 2 mm

Gate Latch

- 304 Stainless Steel
- Automatic Latching
- Robust Construction
- Easy to install



434-9624 48 x 37 x 56mm

Toggle Latch

- Removable shaft
- Stainless Steel and Rubber construction
- M4 Fixing holes



339-9151 130 x 34 x 22mm

PVC Edging Strip

- Black soft sponge rubber sealing strip with steel wire insert
- Applications include providing edge protection for sheet material e.g. door panels
- May also be used to reduce noise and wear resulting from vibration



619-1714 9.5mm x 12mm

727-6037 8.5mm x 1mm

619-1506 1-2,9x6

619-1512 1-3,12x9

619-1528 14.4 x 10.5

619-1534 17x10.5

Sponge Rubber Door and Window Sealing Strip

- High-quality extruded EPDM (ethylene propylene diene monomer) sponge rubber sealing strip designed for use as door seal or window seal.



727-6096 Black, 12mm x 14mm x 20m

Brush Strip

- Robust design with aluminium carrier
- 180° mounting angle
- Easy to assemble
- The strip can be cut to size using hacksaw or bolt cutters
- -50°C to +100°C temperature range
- Resistant to most common solvents
- Supplied in a 1-metre strip length with instructions



326-9909 50mm

326-9937 60mm

444-2537 838mm

619-1635 Black, 15mm x 6.8mm x 20m

Thermoplastic Handles

- Black, non chip material
- Threaded brass inserts



456-551 40.5 mm H, 20mm W, 107mm L

Tubular Plain Finish Handles

- High Grade 304 stainless steel
- suitable for harsh environments
- Screws supplied



237-895 30 mm H, 9mm W, 104mm L
237-902 30 mm H, 9mm W, 129mm L

ABS Quick Fit Pull Handle

- Black
- ABS Plastic
- one Piece



161-1959 38 mm H, 36mm W, 93mm L

Aluminium Handle

- Durable, hardwearing aluminium
- Professional finish
- Suitable for harsh environments
- Easy to clean and maintain



237-439 Black, 53 mm H, 26mm W, 130mm L
237-889 Silver, 34 mm H, 8mm W, 60mm L
237-873 Silver, 34 mm H, 8mm W, 88mm L

Tubular Electro Polished Handles

- Tubular 316 stainless steel
- M6 screws needed for installation



456-567 60 mm H, 25mm W, 220mm L

Drawer Handle

- Fibreglass reinforced nylon
- Matte Finish
- Black



267-1519 40 mm H, 29mm W, 145mm L

Black Nylon Drawer Handles

- reinforced glass filled nylon
- Hollowed centre profile
- Moulded 5.3 mm Dia. threaded bore
- M6 hexagon bolts inserted from above for easy installation
- Black cover caps included for a tidy finish



456-589 28 mm H, 22mm W, 112mm L
456-501 28 mm H, 24mm W, 141mm L
456-490 40 mm H, 28mm W, 140mm L
456-517 44 mm H, 28mm W, 168mm L

Fix Pull Handle

- Stainless Steel
- Satin Finish
- Natural Colour



894-6844 19 mm H, 150mm L

ENGINEERING MATERIALS & INDUSTRIAL HARDWARE

RS PRO provides industrial hardware such as screws, bolts, nuts, and engineering materials like plastics, metals, and composites.

Acoustic Insulation

- Thickness of 21mm for resistance to cuts
- Complies with SAE J369 standards for self-extinguishing properties in automotive application
- Non-woven polypropylene scrim screen helps prevent rotting
- Resistance to moisture, mould and mildew for safe use in humid environments



881-4557 Plain, 1000 x 600 x 21mm

Nomex Thermal Insulation

- Flame-retardant
- Made from Nomex fibre
- Material density of 0.96 g/cm³
- Maximum operating temperature of +300 °C
- Thermal conductivity of 0.139 W/mK



775-7469 304mm x 200mm x 0.25mm

Anti-Slip Pads

- Non-slip pad in round shape
- Adhesive polymer construction
- Withstands continuous temperature of 0°C to 50°C
- Offers high non-slip properties, such as an excellent shock and vibration resistance
- The pack contains 24 Adhesive Pads

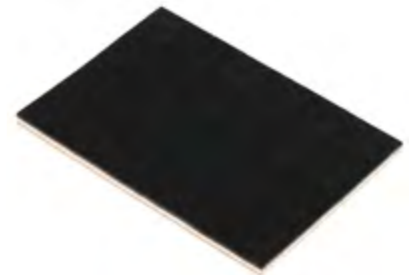

302-2946 8mm Dia, 3mm H

Natural Aluminium Sheet

- Flexible and easily formed medium strength aluminium alloy
- Ideal for various applications such as pressing and panel work
- Good chemical and weathering properties
- Flexible alloy, easily formed

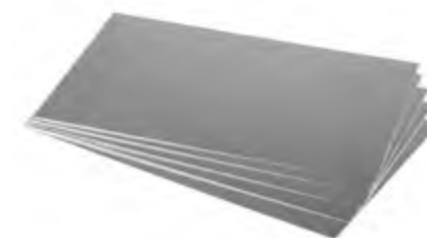

434-043 200mm x 300mm x 1.2mm

Colour Coded Plastic Shim Kit

- Our Plastic Shim provides excellent wear-resistant
- The plastic matte shows high strength to weight ratio and you can consider as an alternative to metallic shimming materials

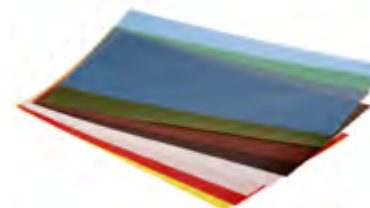

681-407 8 x Plastic - Blue, Brown, Green, Orange, Red, Transparent, White, Yellow

Adjustable Height Mount

- Adjustable mounts are used for levelling and support in many applications including food processing units, packing systems and conveyor systems.



185-4500 Mild Steel Threaded Mount with Plastic Foot, M10, 50 mm, 40 mm Dia.
196-5338 Plastic Foot with 30 Degree Articulation, M12, 150 mm, 83 mm Dia.
196-5348 Stainless Steel foot with 10° articulation, M14, 100 mm, 50 mm Dia.

Bobbin mounts

- Compact, cost effective and easy to install
- Large variety of sizes and fixing types
- Also available in stainless steel



Anti Vibration Mount

- 100% molded polyurethane
- Black foot color
- Suitable for various substrates including plastics, wood, metal, etc.
- Easy peel-off application, non-marking, non-skidding, non-staining
- Shock-dampening, superior abrasion resistance, vibration-resistant

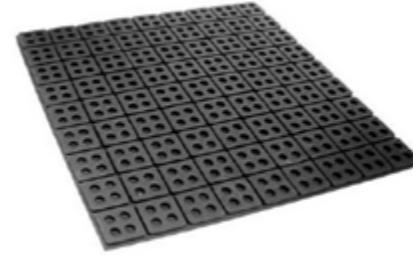

126-3940	Stud , M/M, 12.5 x 20mm, M5 x 12 50 ShA
126-3950	Stud , M/M, 20 x 20mm, M6 x 18, 60 ShA
126-3966	Stud , M/M, 30 x 25mm, M8 x 20, 60 ShA
126-3976	Stud , M/M, 40 x 40mm, M8 x 20, 60 ShA
126-3981	Stud , M/M, 50 x 35mm, M10 x 25, 60 ShA
126-4340	Stud, F/F, 20 x 15mm, M6, 65 ShA
126-4911	Stud, F/F, 40 x 40mm, M8, 60 ShA
126-4914	Stud, F/F, 50 x 45mm, M10, 60 ShA
126-4283	Stud, M/F, 10 x 8mm, M4 x 6 55 ShA
126-4294	Stud, M/F, 20 x 10mm, M6 x 10, 60 ShA
126-4298	Stud, M/F, 20 x 25mm, M5 x 15, 45 ShA
126-4316	Stud, M/F, 40 x 20mm, M8 x 23, 60 ShA
126-4961	Stud Foot, M, 30 x 17mm, M8 x 30, 60 ShA
196-1358	Foot, M, 20 x 15mm, M6 x 6, 60 ShA
162-3237	Cylindrical,F/F, 20 x 20mm M6 60 ShA
126-3924	Cylindrical,F/F, 30 x 40mm M6 45 SHA SS
126-3926	Cylindrical,F/F, 50 x 45mm M10 55 SHA SS
126-3918	Cylindrical,M/F, 30 x 20mm M8 x 20 55 SHA SS
126-3912	Cylindrical,M/M, 30 x 20mm M8 x 20 55 SHA SS
162-3243	Cylindrical, M/M, 40 x 20mm, M10, 70 ShA
162-3236	Cylindrical, M/M, 60 x 25mm, M10, 70 ShA
196-1339	Cylindrical, M/F, 6 x 7mm, M3 x 6, 60 ShA
189-3269	Cylindrical, M/F, 16 x 15mm, M5, 60 ShA
189-3234	Cylindrical, M/M, 25 x 15mm, M6, 45 ShA
189-3310	Cylindrical, M/M, 25 x 20mm, M8, 50 ShA
189-3242	Cylindrical, M/M, 40 x 30mm, M8, 50 ShA

173-5948	Square, 7.6mm H x 20.6mm DIA
173-5956	Cylindrical, 3mm H x 20.6mm DIA
173-5965	Cylindrical, 3.5mm H x 12.7mm DIA

Non-Slip Waffle Rubber Mounting Pads

- Re-useable RS PRO anti-vibration pad is lightweight, easy to use and hassle-free to place in areas where vibration needs to be isolated
- Can easily fit under most industrial and manufacturing machines, while the cup design on both sides creates a suction effect on the mating surfaces to provide a positive grip, isolating the equipment and stopping movement

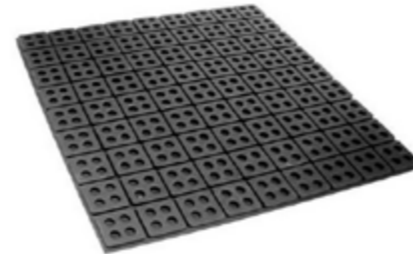

203-5157	19mm
----------	------

Round Anti Vibration Feet

- Screw Fixing Feet
- Moulded feet for use on instrument cases, etc



382-2386 Fixing hole 4BA

Round Anti-Vibration Mount

- Fast foot anti-vibration mounting type



172-0853 Black, Dia 25 mm

Anti Vibration Mount

- PE Material
- Maximum continuous temperature: 50°C
- Maximum intermittent temperature: 70°C
- Long lifespan
- Versatile usage (commercial and domestic)



543-232 19mm Dia x 10.2mm H

Multiple Lobe Knob

- Flame retardant



188-3460 M6 x 28mm

Duroplast Ball Knobs

- Moulded threads
- Resistant to most industrial chemicals, oils, grease, and adverse weather, including ultra-violet light
- Gloss Black
- Temperature rating -30 to + 140°C
- Made to BS771 standards



686-014 Female, M5 x 19mm

686-036 Female, M8 x 32mm

Female Metal Lobe Knob

- Stainless steel with matt finish
- Machined thread

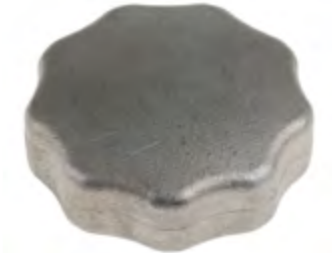

478-967 Female knob, M10, 50mm

Black Nylon Knurled Thumbscrew Knobs

- Thermoplastic body and zinc-plated steel stud
- High tensile strength yet light in weight
- Tapered low profile for space-restricted applications



830-4145 M4 x 10mm

Through Thread Metal Lobe Knob

- Forged hand knobs with a high tensile strength and a smooth surface
- Highly polished domed head
- Aluminium
- Machine thread



478-428 Knob, Aluminium, 40mm, M8

478-484 Male, M6 x 30

Thermoplastic Multiple-Lobed Knobs

- Thermoplastic handles with matte black finish
- Zinc plated steel or stainless steel studs
- Resistant to most chemicals, UV light and water absorption (1.5% max)
- Working temperature range of -20°C to +110°C. Can short term withstand +170°C.



702-7655 Female Knob, Stainless steel, M8 x 12, 40mm Dia

702-7576 Male Knob, Zinc-plated steel, M8 x 20, 40mm Dia

702-7800 Black, M8X30mm

161-133 Male, Zinc plated steel, M5 x 20

161-149 Male, Zinc plated steel, M6 x 20

161-082 Female, Brass, M6 x 20

Knurled (Self Assembly) Thumb Screw Knobs

- Black Gloss Delrin acetal resin
- Can be assembled into complete threaded knobs by inserting a socket head cap screw (not supplied) into the base of the cap
- To avoid over-pressure, use a stop or spacer equivalent to length of screw less depth of screw head



771-667 13 mm Dia. x M4

771-673 16 mm Dia. x M5

771-689 19 mm Dia. x M6

771-651 9.6mm Dia. x M3

Natural Rubber Sheets

- Commercial grade natural rubber sheet
- Colour Black

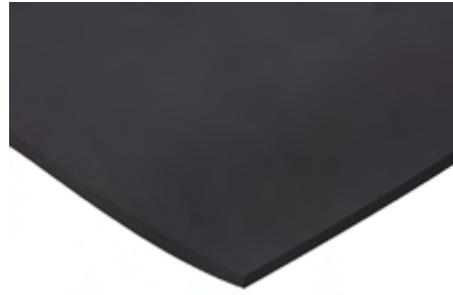

506-3078 1m x 600mm x 1.5mm
506-3163 1m x 600mm x 1.5mm
506-3264 600mm x 600mm x 1.5mm

Neoprene Rubber Sheets

- Black Neoprene Rubber
- Flexible, Durable & Customisable
- Resistant to ozone, sunlight and atmospheric ageing
- Various size and thickness available

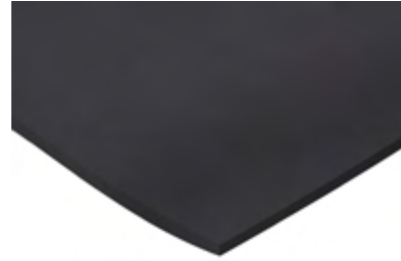

506-3157 1m x 600mm x 3mm

Solid Silicone Rubber Sheet

- Wide operational temperature range
- Good electrical insulation properties
- Good resistance to ozone, oxidation, ultraviolet light, corona, discharge, cosmic radiation, ionizing radiation and weathering in general

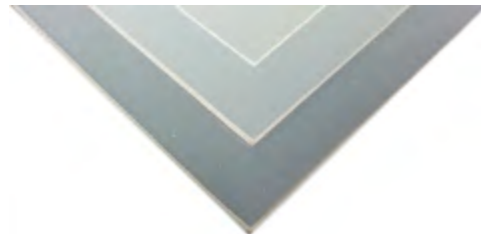

840-5541 600mm x 600mm x 1.5mm

Neoprene Sponge Rubber

- A closed cell neoprene sponge offering good recovery
- Resistant to ozone, sunlight and atmospheric ageing

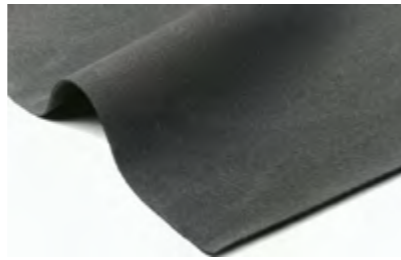

733-6753 1m x 2m x 1.5mm

Neoprene Rubber

- Used in outdoor applications where resistance to atmospheric ageing sunlight and seawater are required
- Hardness IRHD 60°
- Density 1.4 g/cm³



506-3163 1m x 600mm x 1.5mm
506-3264 600mm x 600mm x 1.5mm
506-3078 1m x 600mm x 1.5mm

Nylon sheets

- Maximum operating temperature of +160 °C
- Resistance to oils, grease, petrol
- Easily welded
- Ultraviolet and weather resistance.

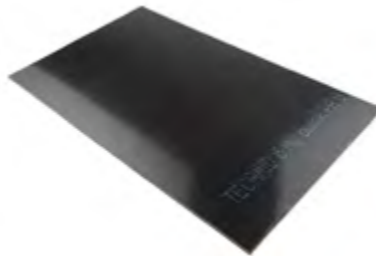

282-0711 500mm x 300mm x 6mm

Mylar Plastic Film

- Mylar plastic electrical and chemical insulating film
- Versatile, multipurpose, transparent plastic film
- Flexible, strong and durable with excellent resistance to water and most chemicals
- Operating temperature range of -70°C to +150°C
- Supplied in lot of 5



785-0795 304mm x 200mm x 0.075mm

Mica Film

- Outstanding electrical insulation at high temperatures
- Resists extreme high temperature cycles
- Can be easily cut or punched
- Environmentally safe and non-toxic
- Supplied in lot of 5



785-0815 304mm x 200mm x 0.25mm

Acrylic Sheet

- High chemical resistance thermoplastic
- Available in either cast or extruded types
- Surface quality achieved by casting against glass
- 92% Light transmission
- Excellent long term weather resistance with no discolouration



434-295 500mm x 300mm x 3mm

Acetal Rod

- High Strength
- Difficult to bond
- Good slide and wear properties
- Good machinability
- Not hot water resistant over 60°C
- Good chemical resistance
- Easy to polish



197-4283 Black, 25.8mm Dia., 1m length
514-512 White, 10mm Dia., 1m length

White Nylon Rod

- Nylon rod with density of 1.14 g/cm³
- Elongation of 150%, UL HB flammability rating
- Hardness of 170 ball indentation
- Maximum operating temperature: +170°C
- Tensile strength: 60 MPa wet, 80 MPa dry
- Water absorption: 8.5%



680-246 1 m x 10 mm Dia.

Clear Round Acrylic Tube

- PA sheet : Polyamide
- Made from acrylic, round tube form and clear in colour
- Maximum operating temperature +70°C
- Hardness of M 90 Rockwell
- Thermal conductivity of 0.19 W/mK
- Water absorption of 0%
- Elongation of 5%
- Density of 1.18 g/cm³



408-4018 12mm OD, 8mm ID, 1m Length

Beige Polyetheretherketone PEEK Rod

- Beige colour
- Density of 1.32 g/cm³
- Elongation of 25%
- UL (Underwriters' Laboratories) 94 V-0 flammability rating



514-748 300 mm x 6 mm Dia.

PLUMBING & PIPELINE

Explore RS PRO's plumbing products, including pipes, valves, fittings, faucets, and plumbing accessories.

Stainless Steel Hexagon Hose Nipple BSPTM - Hose

- 316 Stainless Steel
- 150 lb fitting
- Screwed BSPT (Tapered) connection
- Barbed hose tail connection



499-3754	1/2" R(T) Male / Male 2.22"
499-3732	1/4" R(T) Male / Male 1.69"
499-3776	1" R(T) Male / Male 2.72"
499-3760	3/4" R(T) Male / Male 2.36"
499-3748	3/8" R(T) Male / Male 1.93"

Stainless Steel Octagon Straight Union BSPPF - BSPPF

- 316 Stainless Steel
- 150 lb fitting
- With BSPT (Tapered) and BSPP (Parallel) connections



499-3495	1/2" G(P) Female x 1/2" G(P) Female 1.52"
499-3518	1" G(P) Female x 1" G(P) Female 2.01"
499-3417	1/4" BSPP, Female - Female

Fitting Threaded Coupling NPS

- Designed for the joining of 2 pipes
- Material: 316 Stainless steel
- ASME B16.11



826-7009	1/2"
826-6992	1/4in
826-7002	3/4"
826-6996	3/8"

Stainless Steel 90° Elbow

- 316 Stainless Steel
- 150 lbs fitting
- Various connections available



499-2953	1/2" G(P) Female x 1/2" G(P) Female
499-3322	1/2" R(T) Female x 1/2" R(T) Male
499-3300	1/4" R(T) Female x 1/4" R(T) Male
499-2975	1" G(P) Female x 1" G(P) Female
499-2969	3/4" G(P) Female x 3/4" G(P) Female
499-3338	3/4" R(T) Female x 3/4" R(T) Male
499-2852	1/4" BSP, Female - Female
499-2874	3/8" BSP, Female - Female

Stainless Steel 90° Tee BSPP

- 316 Stainless Steel
- 150 lbs fitting
- Various connections available



499-2981	1/2" G(P) Female x 1/2" G(P) Female x 1/2" Female G(P) 2.17"
499-2880	1/4" G(P) Female x 1/4" G(P) Female x 1/4" Female G(P) 1.54"
499-3007	1" G(P) Female x 1" G(P) Female x 1" Female G(P) 2.76"
499-2997	3/4" G(P) Female x 3/4" G(P) Female x 3/4" Female G(P) 2.36"

Stainless Steel Hexagon Bush BSPTM - BSPPF

- 316 Stainless Steel
- 150 lb fitting
- With BSPT (Tapered) and BSPP (Parallel) connections



499-3451	1/2" R(T) Male x 1/4" G(P) Female 0.87"
499-3445	1/2" R(T) Male x 3/8" G(P) Female 0.87"
499-3530	1" R(T) Male x 1/2" G(P) Female 1.06"
499-3546	1" R(T) Male x 3/4" G(P) Female 1.06"
499-3524	3/4" R(T) Male x 1/2" G(P) Female 0.91"

Stainless Steel Hexagon Hexagon Nipple BSPTM - BSPTM

- 316 Stainless Steel
- 150 lb fitting
- With BSPT tapered screw end
- Hexagon Nipple is made from S/40 pipe



499-3041	1/2" R(T) Male x 1/2" R(T) Male 1.65"
499-2931	1/4" R(T) Male x 1/4" R(T) Male 1.26"
499-3063	1" R(T) Male x 1" R(T) Male 1.93"
499-3057	3/4" R(T) Male x 3/4" R(T) Male 1.71"
499-2947	3/8" R(T) Male x 3/8" R(T) Male 1.26"

Stainless Steel Hexagon Plugs BSPTM

- 316 Stainless Steel
- 150 lb fitting
- With BSPT tapered screw end
- Hexagon plug is made from S/40 pipe



499-3394	1/4" R(T) Male 0.71"
499-3467	1/2" R(T) Male 0.89"
499-3473	3/4" R(T) Male 0.92"
499-3401	3/8" BSPT M

Stainless Steel Hexagon Plug NPT

- National Pipe Thread (NPT) taper standard
- Plug fitting type
- Hexagon shape



222-6591	1/2" Male
826-7021	1/4in

Fitting Hex Head Bushing NPS

- Hexagon male/female bushing with threads on the outside and inside
- Reduce from one pipe size to another
- Hexagon shaped head allows you to tighten using a wrench
- Material: 316
- ASME B16.11



826-7074	1/4in
826-7080	3/4"
826-7078	3/8"

Fitting Hex Nipple NPS

- Used for connecting two fittings
- Male to Male joints
- Material: 316
- BS3799



826-7056	3/4"
826-7059	3/8"

Stainless Steel Circular Barrel Nipple BSPTM

- 316 Stainless Steel
- 150 lb fitting
- With BSPT tapered screw end
- Barrel Nipple is made from S/40 pipe



499-3243	1/2" R(T) Male x 1/2" R(T) Male 2.36"
499-3265	1" R(T) Male x 1" R(T) Male 2.36"

Stainless Steel Socket BSPPF - BSPPF

- 316 Stainless Steel
- 150 lbs fitting
- BSP female connections at both ends



499-3013	1/2" G(P) Female x 1/2" G(P) Female
499-2903	1/4" G(P) Female x 1/4" G(P) Female
499-3035	1" G(P) Female x 1" G(P) Female
499-3029	3/4" G(P) Female x 3/4" G(P) Female
499-2919	3/8" G(P) Female x 3/8" G(P) Female

Stainless Steel Screwed End Ball Valves - 2 Piece

- Seat - PTFE/RTFE
- Seal, Packing & Thrust Washer - PTFE
- Spring Washer & Nut - AISI 304
- Handle & Locking Device - Stainless Steel
- Handle Sleeve - PVC



764-4250	1/2" BSPP
764-4262	1 " BSPP, 2 Way
764-4278	2" BSPP
764-4269	3/4 " BSPP

Stainless Steel Screwed End Ball Valves - 2 Piece

- 2-Piece ball valve with screwed end
- Stainless steel - superior corrosion resistance, ideal for demanding applications with high temperatures
- Suited to higher pressure and temperature applications
- Full port 1/4 inch to 3 inches (DN8 - DN80)
- W.P: 1000 WOG (Water, Oil, Gas rating for the valve) (PN63)
- W.T: -20°C to 200°C



764-4256	1/4" BSPP, F-F
----------	----------------

Stainless Steel High-Pressure Ball Valve - 2 Way - BSPP/NPT

- Two-way
- Threaded attachment type
- Stainless steel ball, body & handle material
- Blue-coloured, lever handle type
- Maximum working pressure of 1000 psi (pounds per square inch)
- Safe for use with gas, water and oil



764-4238	3/4"
764-4234	1/2" 2 Way
764-4247	1", BSPP, Seat - PTFE/RTFE
764-4240	1 1/4" BSPP
764-4244	1 1/2" NPT
764-4253	2"

Stainless Steel Quarter-turn L- and T-Port Manual Ball Valves

- Used for controlling flow and are excellent choice for shut-off applications
- Durable and perform well even after long period of time
- Operating Temperature Range: -15 to +232 C
- Pressure Rating WOG: 68 bar
- Gland Nut, Handle, Stop-bolt and Lock Plate - AISI 304 Stainless Steel
- Body Seal, Seal, Thrust Washer and Stem Pack Material - PTFE



499-1950	3/4" BSP, F 3 Way, T Port
499-1887	1/2" BSPP, 3 Way, L Port
499-1944	1/2" BSPP, 3 Way, T Port
499-1966	1" BSP, F, T Port, 3 Way
499-1938	3/8" BSP, F, T Port
499-1865	1/4" BSP, F, L Port
499-1893	3/4" BSP, F, L Port
499-1871	3/8" BSP, F, L Port

Stainless Steel High Pressure Ball - 2 Way - Valve 1 in BSPP

- Threaded Connection 1 in BSPP
- Safe For Use With Gas, Oil, Water
- Handle Material Stainless Steel
- 2 Way Type
- Applications include Heating systems; Water treatment; Liquid flow control
- Working Temperature -20°C to 200°C
- Maximum Working Pressure 68 bar
- Ball seat PTFE/RTFE



499-2789	1/4 " BSPP
499-2795	1/2" BSPP, 2 Way
499-2802	3/4 " BSPP
499-2818	1 " BSPP, 2 Way
499-2824	1-1/4 inch BSPP
499-2830	1-1/2" BSPP, 2 Way
499-2846	2" BSPP, 2 Way

Screwed End Ball Valve BSPP F-F 2013NM - 3 Piece

- 3-Piece design allows in-situ maintenance and servicing
- Lockable Full Bore valves with thermally insulating lever sleeve
- Incorporates ISO-5211 mounting flange for suitable actuator
- Blow Out Proof Stem with Adjustable Stem packing
- Body Material Carbon Steel
- Seal, Thrust Washer, Stem Pack Material - P.T.F.E
- Seat Material - P.T.F.E (15% Reinforced Glassfibre)



764-4216	3/4". BSPP, F-F Carbon Steel
764-4228	1 1/4" BSPPF-F
764-4212	1/2". BSPP, F-F, Carbon Steel
764-4231	2" BSPPF-F, Carbon Steel

Steel Tee Handle Full Port (BSPP)

- Suitable for oil, air, water, saturated steam or high temperature hot water services
- Hot forged sand blasted, nickel plated brass body and cap
- Pure PTFE self-lubricating seats with flexible-lip design
- No metal-to-metal moving parts
- Blowout-proof nickel plated brass stem
- ISO 228 BSPP threads



733-5205	1/2" F-F
733-5224	1/2" M-F
733-5192	1/4" F-F
733-5211	1/4" M-F
733-5227	3/4" Male - Female
733-5202	3/8", Female - Female

Brass Full Bore Ball Valve - 2 Way

- 24h 100% seal test guaranteed
- Dual sealing system allows valve to be operated in either direction making installation easier
- No metal-to-metal moving parts
- No maintenance ever required
- Handle clearly shows ball position
- Silicone-free lubricant on all seals
- Travel stops on body to avoid stresses at stem
- Chrome plated brass ball for longer life with rinse hole



141-7706	3/8" Female - Female
141-7715	1/2" Male - Female
141-7705	1/4" Female - Female
141-7713	1/4" Male - Female
141-7712	2" Female - Female
141-7714	3/8" Male - Female

Dezincification Resistant Brass Ball Valve - 1/4 Turn

- Designed for areas where there is a problem of dezincification
- New construction technology retains the reliability of brass, and the corrosion resistance of bronze
- Application: Drinking water, water, plumbing
- Operating pressure: PN16 up to 54 mm non-shock cold working pressure
- Ball seats: Pure PTFE self-lubricating, with flexible-lip design
- Chrome plated brass ball for longer life
- Silicone-free lubricant on all seals
- No maintenance ever required



486-378 22 mm

Gas Lever Valves

- Hot pressed, nickel plated brass ball valves
- Used to isolate gas supply
- Chrome finish
- Maximum Working Pressure (Gas): 20 bar
- Working temperature: -20 to 60°C



784-5409 10mm, BSPT

Gas Brass Ball Valve - 2 Way

- Chrome plated brass ball for longer life rinse hole
- Silicone-free lubricant on all seals
- Feature travel stops on body to avoid stress at stem and dual sealing system allows valve to be operated in either direction making installation easier
- No metal-to-metal moving parts
- No maintenance ever required
- Working Temperature: -40°C to +170°C, 0°C to +60°C (gas)
- Maximum Working Pressure: 40 bar up to 2 inch and 30 bar over 2 inch



733-5173	1 1/2" BSPP
733-5164	1 1/4" BSPP
733-5158	1/2" BSPP
733-5261	1/2" BSPP
733-5151	1/4" BSPP
733-5160	1" BSPP
733-5176	2" BSPP
733-5167	3/4" BSPP
733-5154	3/8" BSPP

Brass High-Pressure Ball Valve - 2 Way

- Threaded attachment type
- Brass ball & body material
- PVC (polyvinyl chloride) coated steel handle material
- Maximum working pressure of 32 bar
- Safe for use with air, oil, steam and water



733-5230 1/4" Male - Female, BSPP

Dezincification Resistant Brass Ball Valve - 1/4 Turn

- Designed for areas where there is a problem of dezincification
- New construction technology retains the reliability of brass, and the corrosion resistance of bronze
- Application: Drinking water, water, plumbing
- Operating pressure: PN16 up to 54 mm non-shock cold working pressure
- Ball seats: Pure PTFE self-lubricating, with flexible-lip design
- Chrome plated brass ball for longer life
- Silicone-free lubricant on all seals
- No maintenance ever required



486-293	15 mm
486-306	22 mm
486-344	28 mm

Brass L or T Ball Valves - 1/4 Turn

- S.100/101 reduced bore ball valves with 'L' or 'T' port configuration
- Suitable for oil, air, water, saturated steam, or high temperature hot water
- Operating Temperature: -10°C to +120°C
- Threads: ISO 228 parallel female threads
- Port: Reduced
- Ball seats: Pure PTFE self-lubricating
- Silicone-free lubricant on all seals



486-243	T-Port, 1/2"
486-249	T-Port, 1/4"
486-265	T-Port, 1"
486-287	T-Port, 3/4"
486-255	T-Port, 3/8"

Side Drain Brass Ball Valve - 1/4 Turn

- Ball seats : Pure PTFE self-lubricating, with flexible-lip design
- Silicone-free lubricant on all seals



812-5176 1/2" BSP

Brass Ball Valve - 1/4 Turn

- Dual sealing system - valve can be operated in both directions for easier installation
- Suitable for oil, air, water, saturated steam or high temperature hot water services
- Silicone-free lubricant on all seals
- Operating Temperature : -40°C (-40°F) / +170°C (+350°F)
- Threads : ISO228 parallel female by female



733-5126	1/4" BSPP
733-5139	1/2" BSPP
733-5120	3/8" BSPP
733-5132	3/4" BSPP
733-5136	1" BSPP
733-5145	1-1/4" BSPP

Check Valves - F x F Screwed Iron Connections

- Compact, lightweight, durable and convenient
- DZR Copper Alloy Body
- Nylon/Brass Test Plug
- Nitrile/EPDM rubber 'O' Ring
- Standards: BS EN 13959
- 10 bar



242-2818 Double, 1/2"F x 1/2"F

242-2820 Double, 1"F x 1"F

242-2821 Double, 1 1/4"F x 1 1/4"F

242-2822 Double, 1 1/2"F x 1 1/2"F

Check Valves - Copper X Copper Connection

- Compact, lightweight, durable and convenient
- DZR Copper Alloy Body
- Nylon/Brass Test Plug
- Nitrile/EPDM rubber 'O' Ring
- Standards: BS EN 13959
- 10 bar



242-2824 15mm Dia.

242-2825 22mm Dia.

242-2826 28mm Dia.

Check Valves - Taper

- Compact, lightweight, durable and convenient
- Body: DZR Copper Alloy
- Test Plug: Nylon/Brass
- 'O' Ring: Nitrile/EPDM rubber
- Standards: BS EN 13964



242-2827 Single, 1/2"F x 1/2"F

242-2829 Single, 1"F x 1"F

242-2831 Single, 1 1/2"F x 1 1/2"F

242-2830 Single, 1 1/4"F x 1 1/4"F

Spring Loaded Non Return Brass Valve

- Single non-return valve
- Brass body material
- Maximum working pressure of 12 bar



486-148 1/2"

486-164 1"

486-160 1 1/4"

486-237 1 1/2"

486-233 2"

486-158 3/4"

486-170 3/8"

Brass Single Non-Return Valve - BSPP

- Single non-return valve
- Brass body material
- BSP Thread type



486-221 1 1/2" BSP, Female

486-211 1 1/4" BSP, Female

486-209 1/2" BSP, Female

486-205 1in

486-182 2in

486-215 3/4" BSP, Female

BI Series DZR Single Check Valves

- DZR copper alloy with nickel plated finish
- Spring assistance gives rapid closure
- 10 bar Maximum Working Pressure
- Plastic Cartridge
- NBR Rubber O ring
- Brass Compression Nut & Olive
- Copper x Copper Connections
- Supplied with compression ends that comply with BS EN 1252-2 for use with R250 (halfhard) copper tube.
- Test Plug: Nylon/Brass
- Single and Double Check valve configuration



242-2833 15mm x 15mm

242-2834 22mm x 22mm

242-2835 28mm x 28mm

Stainless Steel Check Valves - BSP

- Stainless Steel body material
- Single Check Valve
- BSP Thread type



499-2622 1/2"

499-2638 3/4"

499-2650 1in

499-2666 1 1/4" BSP,

499-2672 1 1/2" BSP,

499-2688 2"

CIM 32 Brass Check Valves

- Spring loaded
- Brass Material
- Flow in one direction
- 16 bar working pressure



242-2840 Single 1 1/2" valve

242-2839 Single 1 1/4" valve

242-2838 Non-Return Valve, 1" valve

242-2836 Single 1/2" valve

242-2841 Single 2" Valve

242-2837 Non-Return Valve, 3/4" valve

Bronze Check Valve

- Bronze Body Material
- Single Check Valve
- Swing type



284-2711 3/4" BSPT

282-0828 1/2" BSPT

284-2727 1" BSPT

284-2755 2" BSPT

Bronze Check Valve - BSPT

- Single Check Valve
- Bronze Material
- BSPT Thread type



510-3722 1/2" BSPT

510-3788 3/4" BSPT

510-3766 1" BSPT

510-3750 1-1/4" BSPT

510-3744 1-1/2" BSPT

510-3738 2" BSPT

PNEUMATIC CYLINDERS

RS PRO offers a diverse selection of pneumatic cylinders, including single-acting cylinders, double-acting cylinders, compact cylinders, and guided cylinders, providing reliable and precise linear motion control in pneumatic systems.



ISO 6432

Mini Cylinders

- Long service life, optimal economy
- Max 10 bar pressure, 10-25mm bores available
- Corrosion-resistant, lightweight design



Stock No.	Bore Ø	Port Connection	Stroke	use with	Mounting Options				
					Clevis Bracket	Foot	Yoke with Lockable Pin	Rod Ends	Magnetic Switch Bracket
304-3763	16mm	M5	10	use with	176-1600	176-1622		176-1576	176-1625
176-1600	16mm	M5	25	use with	176-1600	176-1622		176-1576	176-1625
304-3482	16mm	M5	50	use with	176-1600	176-1622		176-1576	176-1625
304-3505	16mm	M5	80	use with	176-1600	176-1622		176-1576	176-1625
304-3511	20mm	G1/8	25	use with	176-1609	176-1621	176-1616	176-1575	176-1624
304-3319	20mm	G1/8	50	use with	176-1609	176-1621	176-1616	176-1575	176-1624
304-3555	20mm	G1/8	80	use with	176-1609	176-1621	176-1616	176-1575	176-1624
304-3561	25mm	G1/8	25	use with	176-1609	176-1621	176-1615		176-1623
304-3583	25mm	G1/8	50	use with	176-1609	176-1621	176-1615		176-1623
304-3757	25mm	G1/8	80	use with	176-1609	176-1621	176-1615		176-1623

Clevis Bracket

- Steel clevis bracket



Stock No.	Ø	B	B1	C	H	L	M	N	O	R	S
176-1600	12-16	5,5	6	15	25	27	15	12,1	23	7	3
176-1609	20-25	6,6	8	20	32	30	20	16,1	29,5	10	4

Foot

- Steel foot mount for mini cylinders



Stock No.	Ø	A	B	C	D	G	H	J	R	S
176-1622	12-16	16	5,5	42	32	14	20	20	13,5	4
176-1621	20-25	22	6,6	54	40	17	25	25	18	5

Yoke With Lockable Pin

- Clevis Rod Cylinder
- Steel material

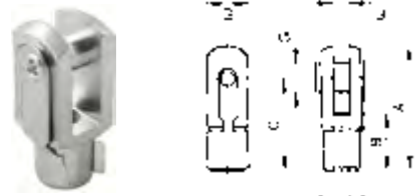

Stock No.	Ø	KK	A	B	C	E	F	G
176-1617	12	M6	31	12	24	12	6	6
176-1616	20	M8	42	16	32	16	8	8
176-1615	25	M10X1,25	52	20	40	20	10	10

Magnetic Switch Bracket

- For use with Mini Cylinders ISO 6432 and Cylinders A95 Series

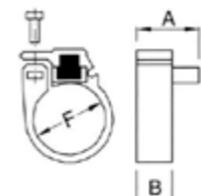

Stock No.	Ø	F = Ø	A	B
176-1625	16	17.3 mm	14	8
176-1624	20	21.3 mm	14	8
176-1623	25	26.3 mm	14	8

Self-Lubricating Rod Ends

- Designed to run dry and are maintenance free
- Steel
- Metric Thread Standard
- Female Connection

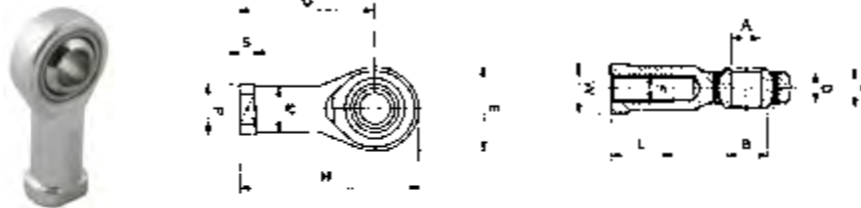

Stock No.	F	A	B	C	Sphere	D	E	G	H	L	M	P	S	W	Radial Load		Weight (g)
															Dynamic (Kg)	Static (Kg)	
176-1597	M6X1	6	8,9	9	12,7	6,75	20	30	40	9	10	13	5	11	470	1100	19
176-1568	M8X1,25	8	10,4	12	15,88	9	24	36	48	12	12,5	16	5	14	780	1900	36
176-1608	M10X1,25	10	12,9	14	19,05	10,5	28	43	57	15	15	19	6,5	17	1200	3100	88
176-1576	M12X1,25	12	15,4	16	22,23	12,5	34	50	67	18	17,5	22	6,5	18	1400	3700	120
176-1575	M16X1,5	16	19,3	21	28,58	15,5	42	64	85	24	22	27	8	24	2500	3600	240

Double Acting Magnetic Cylinders

- Stainless steel AISI 304 cylinder with AISI 303 piston rod
- Anodised aluminum covers, NBR O-ring seals
- Polyurethane seals, neoprene bumper, brass piston, ferrite magnet, zinc-plated steel nut

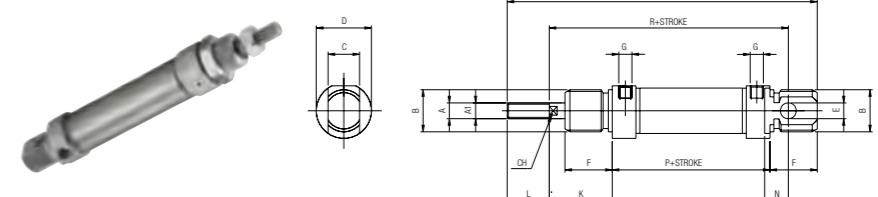

Stock No.	Ø	Stroke	A	A1	B	C	D	E	F	G	K	L	M	N	P	R	CH
176-1619	16	25	M6	6	M16X1,5	12	19	6	18	M5	22	16	109	9	53	82	5
176-1607	16	50	M6	6	M16X1,5	12	19	6	18	M5	22	16	109	9	53	82	5
176-1606	16	80	M6	6	M16X1,5	12	19	6	18	M5	22	16	109	9	53	82	5
176-1604	16	100	M6	6	M16X1,5	12	19	6	18	M5	22	16	109	9	53	82	5
176-1603	16	125	M6	6	M16X1,5	12	19	6	18	M5	22	16	109	9	53	82	5
176-1602	16	160	M6	6	M16X1,5	12	19	6	18	M5	22	16	109	9	53	82	5
176-1601	16	200	M6	6	M16X1,5	12	19	6	18	M5	22	16	109	9	53	82	5
176-1629	20	25	M8	8	M22X1,5	16	27	8	20	1/8G	24	20	131	12	67	95	7
176-1631	20	50	M8	8	M22X1,5	16	27	8	20	1/8G	24	20	131	12	67	95	7
176-1610	20	80	M8	8	M22X1,5	16	27	8	20	1/8G	24	20	131	12	67	95	7
176-1637	20	100	M8	8	M22X1,5	16	27	8	20	1/8G	24	20	131	12	67	95	7
176-1636	20	125	M8	8	M22X1,5	16	27	8	20	1/8G	24	20	131	12	67	95	7
176-1635	20	160	M8	8	M22X1,5	16	27	8	20	1/8G	24	20	131	12	67	95	7
176-1634	20	200	M8	8	M22X1,5	16	27	8	20	1/8G	24	20	131	12	67	95	7
176-1633	25	25	M10X1,25	10	M22X1,5	16	30	8	22	1/8G	28	22	140	12	68	104	9
176-1632	25	50	M10X1,25	10	M22X1,5	16	30	8	22	1/8G	28	22	140	12	68	104	9
176-1620	25	80	M10X1,25	10	M22X1,5	16	30	8	22	1/8G	28	22	140	12	68	104	9
176-1630	25	100	M10X1,25	10	M22X1,5	16	30	8	22	1/8G	28	22	140	12	68	104	9
176-1639	25	125	M10X1,25	10	M22X1,5	16	30	8	22	1/8G	28	22	140	12	68	104	9
176-1628	25	160	M10X1,25	10	M22X1,5	16	30	8	22	1/8G	28	22	140	12	68	104	9
176-1626	25	200	M10X1,25	10	M22X1,5	16	30	8	22	1/8G	28	22	140	12	68	104	9

ISO 6432

Magnetic Switches

- Magnetic reed switch with 2.5m PVC cable
- Yellow LED status indicator, IP68
- Longitudinal mounting, NO operation, -20°C to +70°C operating range



IP68 RATED

Stock No.	Connection - Wires	Sensor type	Voltage Range	Max current at 25°C	Resistive load	Max voltage drop	Response time
176-1580	2 WIRE PVC - 2,5 MT	REED	3-130 V AC/DC	50 mA	10 W	3.2	0.5 ms max
176-1618	3 WIRE PVC - 2,5 MT	PNP - HALL	10-30 V DC	200 mA	6 W	0.8	0.2 ms max

Double Acting Cushioned Magnetic Cylinders

- High performance in compact size
- Chrome steel piston rod, polyurethane seals
- Double acting with stainless steel rod, max 10 bar pressure, conforms to ISO 15552, bore 32-125 mm, robust design, adjustable air cushioning



ISO 15552

Stock No.	Bore Ø	Port connection	Stroke		Mounting Options				
					Male Clevis	Female Clevis	Pedestal	Yoke	Flange
176-1695	32 mm	G 1/8	25 mm	use with	176-1567	176-1573	183-7196		304-4160
176-1704	32 mm	G 1/8	50	use with	176-1567	176-1573	183-7196		176-1613
176-1714	32 mm	G 1/8	80	use with	176-1567	176-1573	183-7196		176-1613
176-1702	32 mm	G 1/8	100	use with	176-1567	176-1573	183-7196		176-1613
176-1701	32 mm	G 1/8	125	use with	176-1567	176-1573	183-7196		176-1613
176-1700	32 mm	G 1/8	160	use with	176-1567	176-1573	183-7196		176-1613
176-1699	32 mm	G 1/8	200	use with	176-1567	176-1573	183-7196		176-1613
176-1698	32 mm	G 1/8	250	use with	176-1567	176-1573	183-7196		304-4160
176-1697	40 mm	G 1/8	25	use with	176-1566	176-1572		176-1614	
176-1696	40 mm	G 1/8	50	use with	176-1566	176-1572		176-1614	
176-1675	40 mm	G 1/8	80	use with	176-1566	176-1572		176-1614	
176-1647	40 mm	G 1/8	100	use with	176-1566	176-1572		176-1614	
176-1684	40 mm	G 1/8	125	use with	176-1566	176-1572		176-1614	
176-1655	40 mm	G 1/8	160	use with	176-1566	176-1572		176-1614	
176-1654	40 mm	G 1/8	200	use with	176-1566	176-1572		176-1614	
176-1653	40 mm	G 1/8	250	use with	176-1566	176-1572		176-1614	
176-1652	50 mm	G 1/4	25	use with	176-1565	176-1571		176-1613	
176-1651	50 mm	G 1/4	50	use with	176-1565	176-1571		176-1613	
176-1650	50 mm	G 1/4	80	use with	176-1565	176-1571		176-1613	
176-1640	50 mm	G 1/4	100	use with	176-1565	176-1571		176-1613	
176-1648	50 mm	G 1/4	125	use with	176-1565	176-1571		176-1613	
176-1657	50 mm	G 1/4	160	use with	176-1565	176-1571		176-1613	
176-1646	50 mm	G 1/4	200	use with	176-1565	176-1571		176-1613	
176-1645	50 mm	G 1/4	250	use with	176-1565	176-1571		176-1613	
176-1644	63 mm	G 3/8	25	use with	176-1564	176-1561			
176-1643	63 mm	G 3/8	50	use with	176-1564	176-1561			
176-1642	63 mm	G 3/8	80	use with	176-1564	176-1561			
176-1641	63 mm	G 3/8	100	use with	176-1564	176-1561			
176-1666	63 mm	G 3/8	125	use with	176-1564	176-1561			
176-1668	63 mm	G 3/8	160	use with	176-1564	176-1561			
176-1649	63 mm	G 3/8	200	use with	176-1564	176-1561			
176-1674	63 mm	G 3/8	250	use with	176-1564	176-1561			
176-1673	80 mm	G 3/8	25	use with	176-1563	176-1569	183-7193	176-1612	
176-1672	80 mm	G 3/8	50	use with	176-1563	176-1569	183-7193	176-1612	
176-1671	80 mm	G 3/8	80	use with	176-1563	176-1569	183-7193	176-1612	
176-1670	80 mm	G 3/8	100	use with	176-1563	176-1569	183-7193	176-1612	
176-1669	80 mm	G 3/8	125	use with	176-1563	176-1569	183-7193	176-1612	
176-1658	80 mm	G 3/8	160	use with	176-1563	176-1569	183-7193	176-1612	
176-1667	80 mm	G 3/8	200	use with	176-1563	176-1569	183-7193	176-1612	
176-1676	80 mm	G 3/8	250	use with	176-1563	176-1569	183-7193	176-1612	
176-1665	100 mm	G 1/2	25	use with	176-1562	176-1578	183-7192		
176-1664	100 mm	G 1/2	50	use with	176-1562	176-1578	183-7192		
176-1663	100 mm	G 1/2	80	use with	176-1562	176-1578	183-7192		
176-1662	100 mm	G 1/2	100	use with	176-1562	176-1578	183-7192		
176-1661	100 mm	G 1/2	125	use with	176-1562	176-1578	183-7192		
176-1660	100 mm	G 1/2	160	use with	176-1562	176-1578	183-7192		
176-1659	100 mm	G 1/2	200	use with	176-1562	176-1578	183-7192		
176-1713	100 mm	G 1/2	250	use with	176-1562	176-1578	183-7192		

Female Clevis Bracket

- Self-lubricating bushes
- Aluminium

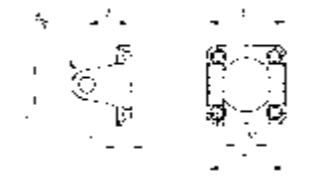

Stock No.	Ø	B	E	G	T	Z	CM	MR
176-1573	32	9	45	10	45	22	26	26
176-1572	40	9	52	12	52	25	28	28
176-1571	50	11	65	12	60	27	32	32
176-1561	63	11	75	16	70	32	40	40
176-1569	80	14	95	16	90	36	50	50
176-1578	100	14	115	20	110	41	60	60

Male Clevis Bracket

- Self-lubricating bushes
- Aluminium



Stock No.	Ø	B	E	G	Z	CM	MR
176-1567	32	9	45	10	22	26	10
176-1566	40	9	52	12	25	28	12
176-1565	50	11	65	12	27	32	12
176-1564	63	11	75	16	32	40	16
176-1563	80	14	95	16	36	50	16
176-1562	100	14	115	20	41	60	20

Steel Clevis Pin

- Bore pin with circlip
- Easy disassembly and reassembly

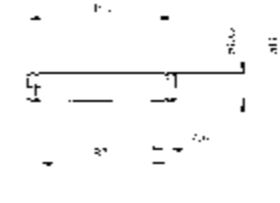

Stock No.	Ø	G	BT	BU	CG	CH
176-1593	32	10	46	53	9.6	1,1
176-1592	40	12	53	60	11.5	1,1
176-1591	50	12	61	68	11.5	1,1
176-1579	63	16	71	78	15.2	1,1
176-1589	80	16	91	98	15.2	1,1
176-1599	100	20	111	118	19	1,3

Yoke With Lockable Pin

- Steel yoke with lockable pin for pneumatic cylinders
- Fit bore sizes 12mm to 80mm Dia.

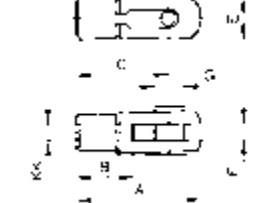

Stock No.	Ø	KK	A	B	C	E	F	G
176-1617	12	M6	31	12	24	12	6	6
176-1616	20	M8	42	16	32	16	8	8
176-1615	25	M10X1,25	52	20	40	20	10	10
176-1614	40	M12X1,25	62	24	48	24	12	12
176-1613	50	M16X1,5	83	32	64	32	16	16
176-1612	80	M20X1,5	105	40	80	40	20	20

Low-Rise Pedestal

- Steel

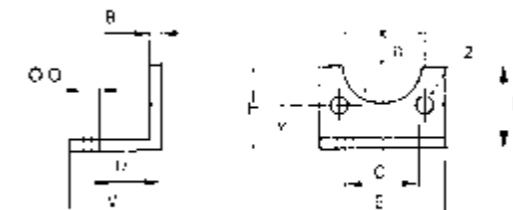

Stock No.	Ø	B	C	E	F	O	U	V	R	Z	X	Y	H
183-7196	32	4	32	45	30	7	24	35	15	7	32,5	15,75	32
183-7193	80	6	63	95	47	12	41	55	22,5	11	72	27	63
183-7192	100	6	75	115	53	14	41	57	27,5	11	89	26,5	71

Flange

- Fits cylinders with bore size of 32mm



304-4160 To Fit Bore 32mm Size

PNEUMATIC VALVES

RS PRO provides a wide range of pneumatic valves, including directional control valves, solenoid valves, shuttle valves, and pressure control valves, offering precise and efficient control of air flow in pneumatic systems for various applications.

Ball Valves

Our RS PRO ball valve range with chrome nickel-plated brass body have been created and engineered to give excellent performance in the field. It is this performance and their compact dimensions that provide a solution to the growing demand of miniaturisation.

APPLICATIONS

- Compressed air, tools
- Pneumatic automation
- Fluid technology
- Food & beverage
- Life & sciences
- Inert gases, vacuum
- Plumbing

MAIN ADVANTAGES

- 2-3 ways with exhaust
- Threads 1/8 to 3/8
- Suitable for multiple fluids
- Supercompact dimension
- Coloured plates for Identification
- Silicon free

ISO 7 Ball Valves

- Super compact design.
- Female thread both sides.
- Brass body material
- Red control button/switch colour
- Handle control mechanism
- Maximum flow rate of 1.4 m³/h
- Maximum operating pressure of 20 bar
- Minimum operating temperature of -20°C
- Maximum operating temperature of +80°C
- International Organisation for Standardisation (ISO) 7 thread standard

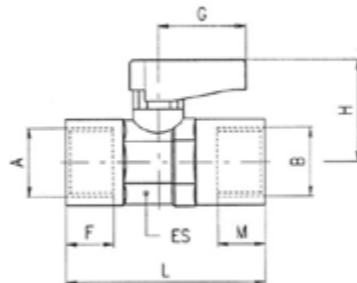

Stock No.	A	B	DN	ES	F	M	L	B	H	Pack
176-2139	1/8	1/8	6	14-15	7.4	7.4	36	19	21	10
176-2140	1/8	1/8	6	14-15	7.4	7.4	36	19	21	10

Direct Action Solenoid Valve 2/2 NC and 2/3 NC

- Brass Body
- Default closed valve position (NC)
- Suitable for Air, Gas, Liquid, Oil, Water Applications
- Suitable for use in the food industry.
- Operating Temperature Range -10°C to +80°C
- Minimum Operating Temperature -20°C
- Maximum Operating Temperature 40°C



Stock No.	Supply Voltage	Connection	Number of Ports	Flow Factor Kv	Orifice Diameter	Max Working Pressure
255-4145	24V	G 1/8	2/2 NC	0.20m ³ /h	3mm	7 bar
255-4150	24V	G 1/4	2/2 NC	0.20m ³ /h	3mm	10 bar
255-4154	220V	G 1/4	3/2 NC	0.09m ³ /h	2mm	8 bar

Solenoid Valves

RS PRO offers this extensive range of Pneumatic Solenoid Valves, allowing users to direct or stop the flow of compressed air in a pneumatic system. This range of RS PRO pneumatic valves come in a wide range of configurations, pressure ranges, port sizes, thread sizes, body materials and mounting types to suit all your industrial automation and pneumatic requirements.

Servo Assisted Solenoid Valve 2/2 NC

- Brass body
- Suitable for Air, Gas, Liquid, Oil, Water Applications
- Servo assisted operation
- Compact design
- Class H coils
- NBR seals
- Power rating of 7.5VA
- Working pressure range of 0.15 - 10 bar



Stock No.	Seal Material	Thread BSPP	Kv m ³ /h	Kv l/min	Admissible Pressure	
					Min. Bar	Max. Bar
255-4180	FKM	G 1/2	3.9	65	0	16
255-4181	FKM	G 3/4	4.8	80	0	16
255-4184	FKM	G 1	4.8	80	0	16

Solenoid Valve Connector

- Black
- IP65 IEC 60529
- Cable Diameter 6+8 mm & 8+11 for size 30-36mm
- Terminals DIN 43650
- Profile gasket as required by UL/CSA certification

IP65 RATED



176-2067 Black, 2 Pins, 30-36 Size

Solenoids

- Regulates the liquid or gas flow into your pressure system.
- Brass body material
- Maximum operating temperature of +80°C
- Maximum working pressure of 40 bar
- Minimum operating temperature of -10°C

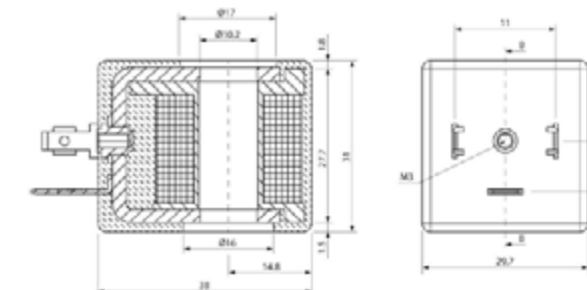

Stock No.	Operator Ø	Size	Voltage	Function	Voltage
176-2069	10	22	24V DC	6.5 w	48V AC
176-2068	10	22	24 V AC	7.5 w	-
176-2073	10	30	24V DC	8 w	48V AC
176-2070	10	22	110V AC	7.5 VA	-
176-2071	10	22	220V DC	7.5 VA	110V DC
176-2072	10	30	24V DC	11 VA	-
176-2075	10	30	110V AC	11 VA	-
176-2062	10	30	220V DC	11 VA	110V DC

Solenoid Pilot Valves

The solenoid pilot valve range is robust, versatile and combines high performances with compact installation dimensions.

Offering large flow capacity, short change-over times and low change-over pressure, the RS PRO range is solenoid, electrical, mechanical or manually operated. They can withstand up to 10 bar working pressure.

APPLICATIONS

- Pneumatic automation, robotics, handling
- Automotive process
- Large range
- Food processing
- Energy saving

MAIN ADVANTAGES

- Extremely durable
- Easy installation
- Textile, packaging
- High flow in a compact dimension

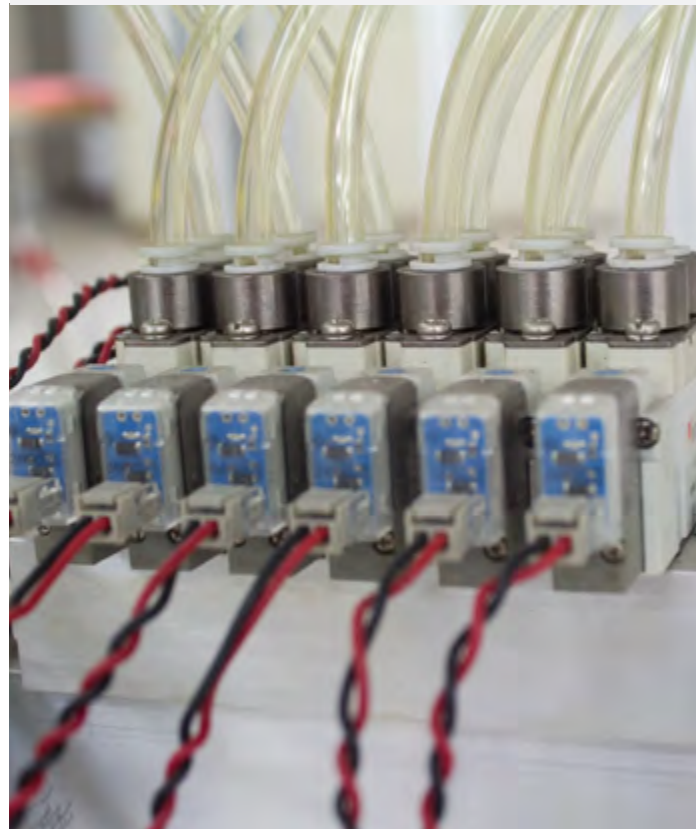

Monostable Spring Return 3/2 Ways

- Pneumatic actuation type
- The aluminium body is lightweight and corrosion-resistant, making this a durable product.
- The valve has an operating temperature range of -10°C up to +60°C, so it's suitable for a variety of environments, including outdoors.
- 4423G port configuration
- 3/2 normally closed function
- Base mounting style
- Single position

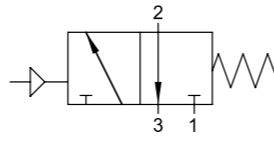

- 176-2116 G 1/8
- 176-2104 G 1/4
- 176-2105 G 1/2

Monostable Spring Return 5/2 Ways

- Extremely Durable
- High Flow in Compact Dimension
- Easy Installation
- Large Range
- Energy Saving
- Base mounting style
- Aluminium body material

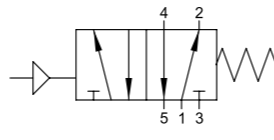

- 176-2106 G 1/8
- 176-2107 G 1/4
- 176-2108 G 1/2

Two Stable Positions 5/2 Ways

- Pneumatic actuation type
- Aluminium body material
- 44232 port thread configuration
- 5/2 Bistable function
- Base mounting style
- Two port positions

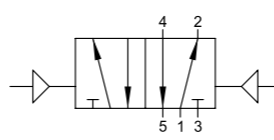

- 176-2109 G 1/8
- 176-2110 G 1/4
- 176-2111 G 1/2

Monostable Spring Return 3/2 Ways

- Solenoid actuation type
- Aluminium body material
- Base mounting style
- Three ports
- Single position
- Solenoid fitted

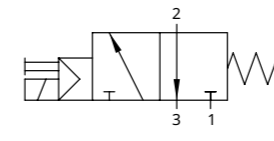

- 176-2112 NC, G 1/8
- 176-2113 NC, G 1/4
- 176-2114 NC, G 1/2

Monostable Spring Return 5/3 Ways

- Solenoid actuation type
- Aluminium body material
- 5/3 normally closed function
- Base mounting style
- Single port position
- Solenoid fitted

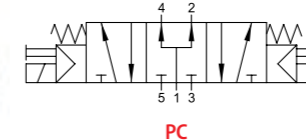
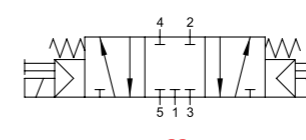

- 176-2102 CC, G 1/8
- 176-2120 CC, G 1/4
- 176-2121 CC, G 1/2
- 176-2122 PC, G 1/8
- 176-2123 PC, G 1/4
- 176-2124 PC, G 1/2

Solenoid Coil

- Ingress protection (IP) rating of IP65
- Operating temperature range of -20°C to +50°C, so you can use it in a wide range of settings, from cold storage units to hot water plumbing setups

IP65 RATED

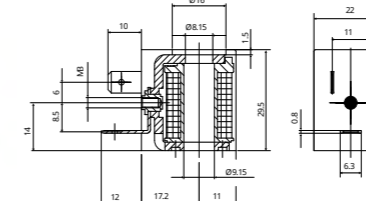

- 176-2128 12V DC, 3W
- 176-2129 24V AC, 3W
- 176-2130 24V DC, 5VA
- 176-2131 110V AC, 5VA
- 176-2118 220V AC, 5VA

Monostable Spring Return 5/2 Ways

- Pneumatic control valve with five ports & 2 positions
- Inline or manifold mount
- Aluminium body

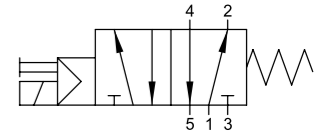

- 176-2115 NC, G 1/8
- 176-2132 NC, G 1/4
- 176-2117 NC, G 1/2

Two Stable Positions 5/2 Ways

- Extremely Durable
- High Flow in Compact Dimension
- Easy Installation
- Operate up to 10 bar working pressure

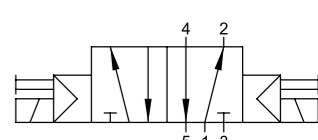

- 176-2125 NC, G 1/8
- 176-2126 NC, G 1/4
- 176-2127 NC, G 1/2

Connector

- Black
- IP65 IEC 60529
- Cable Diameter 6+8 mm for size 22mm
- Terminals INDUSTRIAL AMP
- Profile gasket as required by UL/CSA certification

IP65 RATED

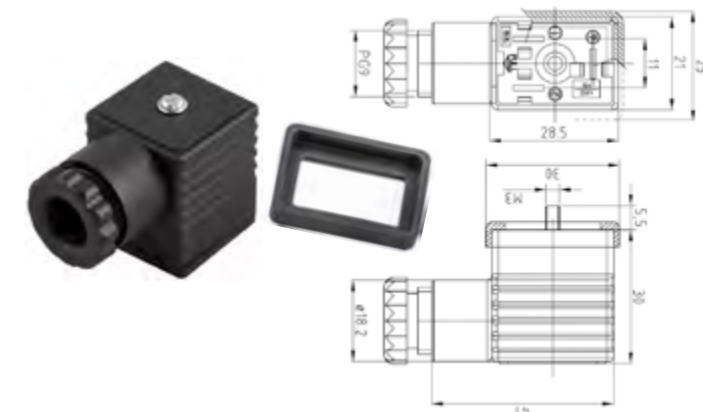

- 176-2066 Black, 22mm, 2 Pins

PNEUMATIC FITTINGS

RS PRO offers a diverse selection of nickel-plated brass and stainless steel adaptors, including nipples, reducers, plugs, and connectors. Constructed from stainless steel AISI 316L, these threaded adaptors are designed for use with corrosive fluids, meeting NSF standards for reliability and safety.

Straight Female Adaptor

- Quick connection and disconnection
- Full Flow and Vacuum resistant tank to special shaped seals
- Lighter and More compact
- Specific configurations to satisfy the advanced robotics
- Silicon Free
- Compatible fluids: Compressed air / Vacuum / Water



Stock No.	Tube	M	L	CH	A max	Pack
176-1296	4	M12x1	31.5	17	7	10
176-1297	6	M14x1	35	17	9.5	10
176-1298	8	M16x1	37	19	10.5	10
176-1775	10	M20x1	43	24	12.5	10
176-1776	12	M22x1	48	26	16.5	10
176-1777	14	M23x1	49	27	16.5	10

Mini - Straight Male Adaptor (Parallel)

- Quick connection and disconnection
- Full Flow and Vacuum resistant tank to special shaped seals
- Lighter and More compact
- Specific configurations to satisfy the advanced robotics
- Silicon Free
- Compatible fluids: Compressed air / Vacuum / Water



Stock No.	A	B	H	CH1	CH2	D	Pack
176-1397	3	M3	3	11	6	1.5	10
176-1398	3	M5	4	10	7	2	10
176-1399	4	M5	3.6	14	9	2.5	10
176-1400	4	1/8	5	11.5	13	3	10
176-1401	6	M5	3.6	16	11	2.5	10
176-1402	6	1/8	5	13.5	13	3	10
176-1404	6	1/4	7.1	12	16	4	10

Elbow Connector

- Quick connection and disconnection
- Full Flow and Vacuum resistant tank to special shaped seals
- Lighter and More compact
- Specific configurations to satisfy the advanced robotics
- Silicon Free
- Compatible fluids: Compressed air / Vacuum / Water



Stock No.	D1	D2	L	D	CH	Pack
176-1352	4	4	16.5	10	9	10
176-1353	6	6	20.5	12	11	10
176-1354	8	8	22	14	13	10
176-1819	10	10	26.5	17	16	10
176-1820	12	12	30	20	19	10

Orienting Elbow

- Quick connection and disconnection
- Full Flow and Vacuum resistant tank to special shaped seals
- Lighter and More compact
- Specific configurations to satisfy the advanced robotics
- Silicon Free
- Compatible fluids: Compressed air / Vacuum / Water



Stock No.	Tube	A	B	L1	L2	CH1	D	Pack
176-1355	4	4	17	16.5	20.8	7	10	10
176-1356	6	6	19	20.5	23.7	9	12.5	10
176-1357	8	8	20	22	26	10	14	10
176-1821	10	10	22.5	26.5	30	13	17	10

Orienting Elbow Male Adaptor "Universal Short"

- Quick connection and disconnection
- Full Flow and Vacuum resistant tank to special shaped seals
- Lighter and More compact
- Specific configurations to satisfy the advanced robotics
- Silicon Free
- Compatible fluids: Compressed air / Vacuum / Water



Stock No.	Tube	A	B	L1	L2	CH1	CH2	D	Pack
176-1332	4	1/8	5.5	16.5	16.5	7	13	10	10
176-1333	4	1/4	7	16.5	18	7	15	10	10
176-1334	6	1/8	5.5	20.5	17.5	9	13	12	10
176-1335	6	1/4	7	20.5	18.9	9	15	12	10
176-1336	6	3/8	7.5	20.5	20	9	17	12	10
176-1337	8	1/8	5.5	22	18.5	10	13	14	10
176-1338	8	1/4	7	22	20	10	15	14	10
176-1339	8	3/8	7.5	22	20.5	10	17	14	10
176-1804	10	1/4	7	26.5	21.8	13	16	17	10
176-1805	10	3/8	7.5	26.5	21.8	13	17	17	10
176-1806	10	1/2	9	26.5	24.3	13	21	17	10
176-1807	12	1/4	7	30	23.1	16	16	20	10
176-1808	12	3/8	7.5	30	23.1	16	17	20	10
176-1809	12	1/2	9	30	25.6	16	21	20	10
176-1810	14	3/8	7.5	31	26.5	18	20	21	10
176-1811	14	1/2	9	31	27	18	21	21	10

Orienting Tee Male Adaptor (Parallel) - Centre Leg

- Quick connection and disconnection
- Full Flow and Vacuum resistant tank to special shaped seals
- Lighter and More compact
- Specific configurations to satisfy the advanced robotics
- Silicon Free
- Compatible fluids: Compressed air / Vacuum / Water



Stock No.	Tube	A	B	L1	L2	CH1	CH2	D	Pack
176-1364	4	1/4	5.4	33	17.1	7	13	10	10
176-1365	4	1/4	7.1	33	18.8	7	16	10	10
176-1363	4	M5	3.6	33	15.5	7	9	10	10
176-1367	6	1/8	5.4	41	18.4	9	13	12.5	10
176-1369	6	1/4	7.1	41	20	9	16	12.5	10
176-1366	6	M5	3.6	41	14.7	9	9	12.5	10
176-1370	8	1/8	5.4	44	22.1	10	13	14	10
176-1371	8	1/4	7.1	44	21.4	10	16	14	10
176-1824	10	1/4	7.1	53	26.7	13	16	17	10
176-1825	10	3/8	8.1	53	26.2	13	20	17	10

Orienting Elbow Male Adaptor (Parallel)

- Quick connection and disconnection
- Full Flow and Vacuum resistant tank to special shaped seals
- Lighter and More compact
- Specific configurations to satisfy the advanced robotics
- Silicon Free
- Compatible fluids: Compressed air / Vacuum / Water



Stock No.	Tube	A	B	L1	L2	CH1	CH2	D	Pack
176-1342	4	1/8	5.4	16.5	15	7	13	10	10
176-1343	4	1/4	7.1	16.5	16.6	9	16	10	10
176-1340	4	M5	3.6	16.5	13.8	7	9	10	10
176-1341	4	M7x1	4.8	16.5	14.4	7	9	10	10
176-1345	6	1/8	5.4	20.5	15.8	9	13	12	10
176-1347	6	1/4	7.1	20.5	17.5	9	16	12	10
176-1348	6	3/8	8.1	20.5	19	9	20	12	10
176-1344	6	M5	3.6	20.5	14.7	9	9	12	10
176-1349	8	1/8	5.4	22	19.4	10	13	14	10
176-1350	8	1/4	7.1	22	18.7	10	16	14	10
176-1351	8	3/8	8.1	22	20.1	10	20	14	10
176-1812	10	1/4	7.1	26.5	22.8	13	16	17	10
176-1813	10	3/8	8.1	26.5	22.3	13	20	17	10
176-1814	10	1/2	9.6	26.5	23.8	13	25	17	10
176-1815	12	1/4	7.1	30	24.1	16	16	20	10
176-1816	12	3/8	8.1	30	23.6	16	20	20	10
176-1817	14	3/8	8.1	31	28.1	18	20	21	10
176-1818	14	1/2	9.6	31	26.1	18	25	21	10

Bulkhead Connector

- Quick connection and disconnection
- Full Flow and Vacuum resistant tank to special shaped seals
- Lighter and More compact
- Specific configurations to satisfy the advanced robotics
- Silicon Free
- Compatible fluids: Compressed air / Vacuum / Water



Stock No.	Tube	A	B	L	CH	Pack
176-1287	4	1/8	8.5	24	13	10
176-1294	4	1/4	11	27.5	16	10
176-1293	4	M5	5.5	21	11	10
176-1288	6	1/8	8.5	26	13	10
176-1290	6	1/4	11	29.5	16	10
176-1291	8	1/8	8.5	27	15	10
176-1292	8	1/4	11	29.5	17	10
176-1295	8	3/8	12	32	19	10
176-1770	10	1/4	11	32	18	10
176-1771	10	3/8	12	33.5	19	10
176-1772	10	1/2	15	39	24	10
176-1773	12	3/8	12	36	21	10
176-1774	12	1/2	15	41	24	10

Reducer

- Quick connection and disconnection
- Full Flow and Vacuum resistant tank to special shaped seals
- Lighter and More compact
- Specific configurations to satisfy the advanced robotics
- Silicon Free
- Compatible fluids: Compressed air / Vacuum / Water

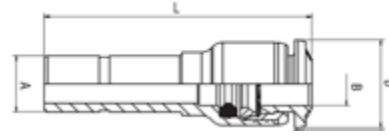

Stock No.	A	B	L	D	Pack
176-1393	6	4	34	10	10
176-1395	8	4	38.5	12	10
176-1394	8	6	39	12.5	10
176-1871	10	6	49,5	14	10
176-1868	10	8	42	14	10
176-1873	12	6	38.5	12.5	10
176-1869	12	8	41.5	14	10
176-1870	12	10	48.5	17	10
176-1874	14	8	37.5	14	10
176-1875	14	10	49,5	20	10
176-1872	14	12	50	20	10

Straight Connector

- Quick connection and disconnection
- Full Flow and Vacuum resistant tank to special shaped seals
- Lighter and More compact
- Specific configurations to satisfy the advanced robotics
- Silicon Free
- Compatible fluids: Compressed air / Vacuum / Water

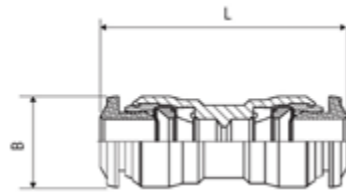

Stock No.	Tube	Tube	L	B	Pack
176-1325	4		31	10	10
176-1326	6		35	12.5	10
176-1328	6	4	34	12.5	10
176-1327	8		37	14	10
176-1331	8	4	37	14	10
176-1329	8	6	37	14	10
176-1796	10		45	17	10
176-1801	10	6	44	17	10
176-1799	10	8	44	17	10
176-1797	12		50	20	10
176-1802	12	8	50	20	10
176-1800	12	10	50	20	10
176-1798	14		48	21	10
176-1803	14	12	48	21	10

Y Connector

- Quick connection and disconnection
- Full Flow and Vacuum resistant tank to special shaped seals
- Lighter and More compact
- Specific configurations to satisfy the advanced robotics
- Silicon Free
- Compatible fluids: Compressed air / Vacuum / Water

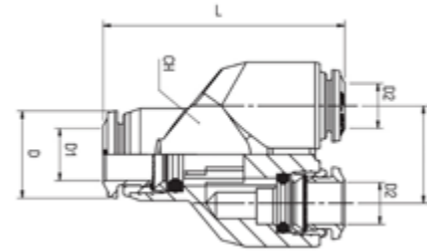

Stock No.	D1	D2	A	L	CH1	D	Pack
176-1378	4	4	11	31.5	10	10	10
176-1381	6	4	13,5	36,5	12	12,5	10
176-1379	6	6	13.5	37	12	12,5	10
176-1382	8	6	15,5	41	14	14	10
176-1380	8	8	15.5	40	14	14	10
176-1834	10	8	19	47,5	17	18	10
176-1832	10	10	19	48.5	17	18	10
176-1833	12	12	22	57.5	20	20	10

Tee Connector

- Quick connection and disconnection
- Full Flow and Vacuum resistant tank to special shaped seals
- Lighter and More compact
- Specific configurations to satisfy the advanced robotics
- Silicon Free
- Compatible fluids: Compressed air / Vacuum / Water

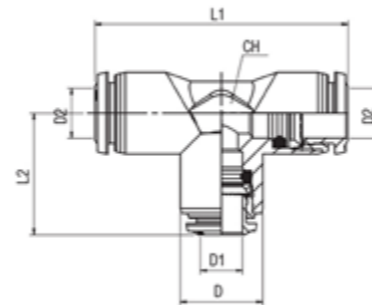

Stock No.	Tube	L1	L2	CH	D	D1	D2	Pack
176-1372	4	33	16.5	9	10	4	4	10
176-1373	6	41	20.5	11	12	6	6	10
176-1376	6-4-6	41	20	11	12.5	4	6	10
176-1375	8	44	22	13	14	8	8	10
176-1377	8-6-8	45	22.5	13	14	6	8	10
176-1826	10	53	26.5	16	17	10	10	10
176-1830	10-8-10	53	26	16	17	8	10	10
176-1827	12	61.5	30	19	20	12	12	10
176-1831	12-10-12	61.5	30	19	20	10	12	10
176-1828	14	61	30.5	20	21	14	14	10

Stainless Steel Push-In Fittings

Fully made of stainless steel AISI 316L, the RS PRO stainless steel push-in range has been developed to drive corrosive fluids or to be used in aggressive environments. The range is ideal for direct contact with food fluids.

This line can be used also in salty environments and on machines that need frequent washing with aggressive detergents.

The series conforms to NSF 61, NSF 169 & NSF 372.

APPLICATIONS

- Automation with washing
- Farming, fining,
- Chemical, petro-chemical, pharmaceutical
- Medical, life & sciences
- Vacuum

MAIN ADVANTAGES

- Quick connection and disconnection
- Full flow and vacuum resistance thanks to shaped seals
- 3 threads available: BSPP, BSPT (universal short) & metric
- Full stainless steel AISI 316L
- Food & beverage compatible

Straight Connector

- Full stainless steel AISI 316L
- Compatible with fluid for food and chemical industry.
- Pressure (140 bar)
- Temperature (-110°C +300°C).
- Silicon Free

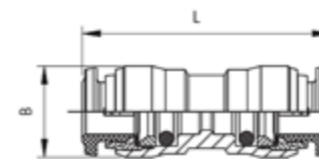

Stock No.	Tube	L	B	Pack
176-2161	4	31	10.5	10
176-2162	6	35	12.5	10
176-2163	8	36.5	14.5	10
176-2164	10	42	17.5	10

Bulkhead Connector

- Full stainless steel AISI 316L
- Compatible with fluid for food and chemical industry.
- Pressure (140 bar)
- Temperature (-110°C +300°C).
- Silicon Free

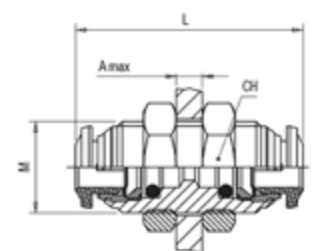

Stock No.	Tube	M	L	CH	A max	Pack
176-2165	4	M12x1	31	17	7	10
176-2166	6	M14x1	35	17	9.5	10
176-2167	8	M16x1	37	19	10.5	10

Orienting Elbow Male Adaptor (Taper)

- Full stainless steel AISI 316L
- Compatible with fluid for food and chemical industry.
- Pressure (140 bar)
- Temperature (-110°C +300°C).
- Silicon Free

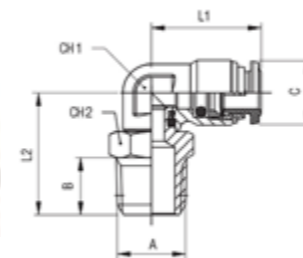

Stock No.	Tube	A	B	C	L1	L2	CH1	CH2	Pack
176-2168	6	1/4	11	12.5	21	26	11	14	10
176-2169	8	1/4	11	14.5	22.5	28,5	12	14	10

Orienting Elbow Male Adaptor (Parallel)

- Full stainless steel AISI 316L
- Compatible with fluid for food and chemical industry.
- Pressure (140 bar)
- Temperature (-110°C +300°C).
- Silicon Free

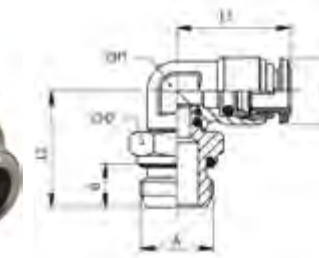

Stock No.	Tube	A	B	C	L1	L2	CH1	CH2	Pack
176-2170	4	M5	4	10	18	10	36	18	10

Nipple (Taper)

- Full stainless steel AISI 316L
- Compatible with fluid for food and chemical industry.
- Pressure (140 bar)
- Temperature (-110°C +300°C).
- Silicon Free

AISI 316L



Stock No.	A	B	L	CH	Pack
176-2178	1/4 in	11	27	14	10
176-2179	3/8 in	11.5	28	17	10
176-2180	1/2 in	14	33.5	22	10

Reducing Nipple (Taper)

- Full stainless steel AISI 316L
- Compatible with fluid for food and chemical industry.
- Pressure (140 bar)
- Temperature (-110°C +300°C).
- Silicon Free

AISI 316L



Stock No.	A	A1	B	C	L	CH	Pack
176-2186	1/8 in	1/4	7.5	11	23.5	14	10
176-2183	1/4 in	3/8	11	11.5	27.5	17	10
176-2184	3/8 in	1/2	11.5	14	31	22	10
176-2185	1/2 in	3/4	14	16.5	37.5	27	10

Reducer (Taper)

- Full stainless steel AISI 316L
- Compatible with fluid for food and chemical industry.
- Pressure (140 bar)
- Temperature (-110°C +300°C).
- Silicon Free

AISI 316L

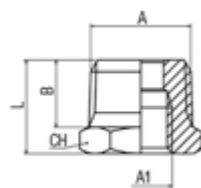

Stock No.	A	A1	B	L	CH	Pack
176-2189	1/4 in	1/8	11	16	14	10
176-2190	3/8 in	1/8	11.5	16.5	17	10
176-2191	3/8 in	1/4	11.5	16.5	17	10
176-2192	1/2 in	1/4	14	19.5	22	10
176-2193	1/2 in	3/8	14	19.5	22	10

Sleeve

- Full stainless steel AISI 316L
- Compatible with fluid for food and chemical industry.
- Pressure (140 bar)
- Temperature (-110°C +300°C).
- Silicon Free

AISI 316L

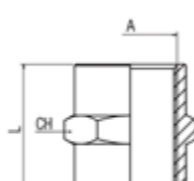

Stock No.	A	B	CH	Pack
176-2194	1/8 in	15	14	10
176-2195	1/4 in	22	17	10
176-2196	3/8 in	24	22	10
176-2197	1/2 in	30	27	10

Male Plug (Taper) DIN 906

- Full stainless steel AISI 316L
- Compatible with fluid for food and chemical industry.
- Pressure (140 bar)
- Temperature (-110°C +300°C).
- Silicon Free

AISI 316L

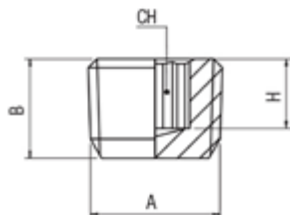

Stock No.	A	B	H	CH	Pack
176-2198	1/8 in	7.5	5	5	10
176-2199	1/4 in	10	7	6	10
176-2200	3/8 in	11	7	8	10
176-2201	1/2 in	13	8	10	10

Male Hose Adapter (Taper) BSPT

- Full stainless steel AISI 316L
- Male connector with male thread
- Straight coupling for food and chemical industries
- Max working pressure: 14 MPa, temperature range: -110°C to +300°C
- Silicon-free

AISI 316L

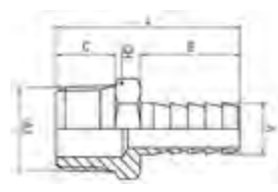

Stock No.	A	A1	B	C	L	CH	Pack
176-2202	7	1/4	19.5	11	35.5	14	10
176-2203	7	1/8	19.5	7.5	32	11	10
176-2204	10	1/4	19.5	11	35.5	14	10
176-2205	10	3/8	19.5	11.5	36	17	10
176-2206	16	1/2	19.5	14	39	22	10

Female Elbow

- Full stainless steel AISI 316L
- Compatible with fluid for food and chemical industry.
- Pressure (140 bar)
- Temperature (-110°C +300°C).
- Silicon Free

AISI 316L



Stock No.	A	C	B	L	CH	Pack
176-2212	1/8	13	8.5	21	10	10
176-2213	1/4	16.5	11	25.5	12	10
176-2214	3/8	20.5	12	28	15	10
176-2215	1/2	25.5	15	32	20	10

Male-Female Elbow

- Full stainless steel AISI 316L
- Compatible with fluid for food and chemical industry.
- Pressure (140 bar)
- Temperature (-110°C +300°C).
- Silicon Free

AISI 316L

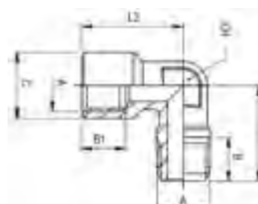

Stock No.	A	B	B1	C	L1	L2	CH	Pack
176-2216	1/8 in	7.5	8.5	13	18	21	10	10
176-2217	1/4 in	11	11	16.5	24	25.5	12	10
176-2218	3/8 in	11.5	12	20.5	27	28	15	10
176-2219	1/2 in	14	15	25.5	29.5	32	20	10

Female Tee

- Full stainless steel AISI 316L
- Compatible with fluid for food and chemical industry.
- Pressure (140 bar)
- Temperature (-110°C +300°C).
- Silicon Free

AISI 316L

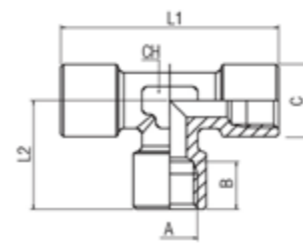

Stock No.	A	A1	B	C	L	CH	Pack
176-2207	1/8	8.5	13	37	18.5	12	10
176-2209	1/4	11	16.5	49	24.5	12	10
176-2211	3/8	12	20.5	54	29	15	10

Stainless Steel Threaded Adaptors

Fully made of stainless steel AISI 316L, the RS PRO threaded adaptor range has been developed to drive corrosive fluids or to be used in aggressive environments. It is ideal for direct contact with food fluids.

This line can be used in salty environments and on machines that need frequent washing with aggressive detergents.

The series conforms to NSF 61, NSF 169 & NSF 372.

APPLICATIONS

- Automation with washing
- Farming, mining
- Chemical, petrochemical, pharmaceutical
- Medical, life & sciences
- Vacuum

MAIN ADVANTAGES

- Quick connection and disconnection
- Full flow and vacuum resistance thanks to shaped seals
- 3 threads available: BSPP, BSPT (universal short) & metric
- Full stainless steel AISI 316L
- Food & beverage compatible
- Silicon free

Silencer

- Full stainless steel AISI 316L
- Compatible with fluid for food and chemical industry.
- 10 bar Pressure
- Temperature (-20°C +300°C).
- Silicon Free
- Filtration threshold 70 µm

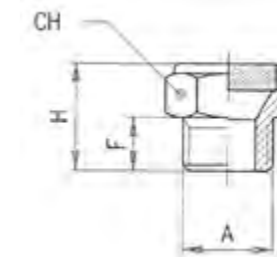

Stock No.	A	F	H	CH	dB*	Pack
176-2220	1/8	8	15	14	73	10
176-2221	1/4	8	15	17	74	10

Male Elbow

- All Fluids compatible Mechanical Resistance
- Silicon Free
- Maximum temperature + 300 °C
- Parallel gas in conformity with ISO 228 Class A.



Stock No.	A	B	L	CH	Pack
176-1075	1/8	7.5	18	11	10
176-1076	1/4	11	24	13	10
176-1077	3/8	12	27	17	10
176-1078	1/2	14	29.5	20	10

Female Tee

- All Fluids compatible Mechanical Resistance
- Silicon Free
- Maximum temperature + 300 °C
- Parallel gas in conformity with ISO 228 Class A.



Stock No.	A	B	L2	L1	C	CH	Pack
176-1058	1/8	8.5	19.5	39	13	12	10
176-1060	1/4	11	24.5	49	16.5	13	10
176-1061	3/8	12	27	54	20.5	16	10
176-1062	1/2	15	32	64	25.5	20	10
176-1063	3/4	16.5	36.5	73	32.5	27	10

Male Hose Adapter (Parallel) with O-Ring

- Male connector and male thread
- Straight coupling type
- Maximum working pressure of 5 MPa, 50 bar

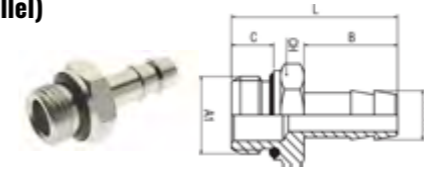

Stock No.	A	B	C	L	D	CH	Pack
176-2038	6	1/4	20	8	34.5	16	10
176-2032	7	1/4	20	8	34.5	16	10
176-2033	8	1/8	20	6	31	13	10
176-2034	8	1/4	20	8	34.5	16	10
176-2039	8	3/8	20	9	35.5	19	10
176-2040	10	1/4	20	8	34.5	16	10
176-2041	10	3/8	24	9	39.5	19	10
176-2042	10	1/2	22	10	39.5	24	10
176-2035	12	1/4	20	8	34.5	16	10
176-2037	13	1/2	22	10	39.5	24	10

APPLICATIONS

- Compressed air
- Pneumatic automation
- Industrial water circuits
- Inert Gases, fluids, Steam
- Vacuum

MAIN ADVANTAGES

- Complete range M5 - 1"
- Compatible with all fluids
- Mechanically resistant
- Standard and bayonet connection
- Silicon free

Female Elbow

- All Fluids compatible Mechanical Resistance
- Silicon Free
- Maximum temperature + 300 °C
- Parallel gas in conformity with ISO 228 Class A.



Stock No.	A	B	L	CH	Pack
176-1079	1/8	8.5	21	11	10
176-1080	1/4	11	25.5	13	10
176-1081	3/8	11.5	28	17	10
176-1082	1/2	15	32	20	10
176-1083	3/4	16.5	36.5	27	10

Male/Female Elbow

- All Fluids compatible Mechanical Resistance
- Silicon Free
- Maximum temperature + 300 °C
- Parallel gas in conformity with ISO 228 Class A.



Stock No.	A	B	B1	C	L	CH	Pack
176-1084	1/8	7.5	8.5	21	18	11	10
176-1085	1/4	11	11	25.5	24	13	10
176-1086	3/8	11.5	12	28	27	17	10
176-1088	1/2	14	15	32	29.5	20	10
176-1089	3/4	14.5	16.5	36.5	32	27	10

Bulkhead Connector

- All Fluids compatible Mechanical Resistance
- Silicon Free
- Maximum temperature + 300 °C
- Parallel gas in conformity with ISO 228 Class A.



Stock No.	A	B	C max	D	E	CH1	CH2	Pack
176-2044	1/8	M16x1.5	10	14	4	22	19	10
176-2045	1/4	M20x1.5	16	21	4	27	24	10
176-2046	3/8	M26x1.5	15	21	5	32	30	10
176-2043	M5	M10x1	7	10.5	3.5	14	14	10

Silencer

- Pressure 12 bar
- Minimum temperature - 10 °C
- Maximum temperature + 80 °C
- Filtration threshold 36 µm



Stock No.	A	F	H	CH	dB*	Pack
176-2283	1/8	6	44	13	76	10
176-2284	1/4	7	50	16	75	10
176-2285	3/8	8	54	19	88	10
176-2286	1/2	9	67	24	89	10

Nipple (Parallel)

- All Fluids compatible Mechanical Resistance
- Silicon Free
- Maximum temperature + 300 °C
- Parallel gas in conformity with ISO 228 Class A.

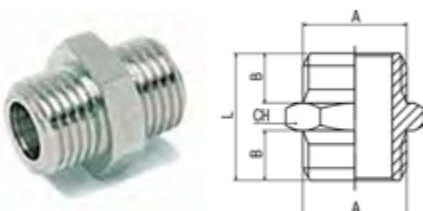

Stock No.	A	B	L	CH	Pack
176-0985	1/8	6	16.5	14	10
176-0986	1/4	8	21	17	10
176-0987	3/8	9	23	19	10
176-0988	1/2	10	25.5	24	10
176-2133	M5	4	11.5	8	10

Reducer (Parallel)

- All Fluids compatible Mechanical Resistance
- Silicon Free
- Maximum temperature + 300 °C
- Parallel gas in conformity with ISO 228 Class A.

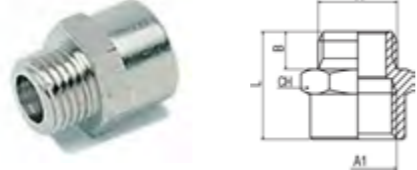

Stock No.	A	A1	B	L	CH	Pk
176-0996	1/8	1/8	6	17	14	10
176-1004	1/8	1/4	6	20.5	17	10
176-0997	1/8	3/8	6	21.5	22	10
176-0998	1/4	1/4	8	22.5	17	10
176-1000	1/4	3/8	8	23.5	22	10
176-1001	1/4	1/2	8	26.5	26	10
176-1002	3/8	3/8	9	24.5	22	10

Reducing Sleeve

- All Fluids compatible Mechanical Resistance
- Silicon Free
- Maximum temperature + 300 °C
- Parallel gas in conformity with ISO 228 Class A.



Stock No.	A	A1	L	CH	Pack
176-1047	1/8	1/4	19	17	10
176-1041	1/8	3/8	20	22	10
176-1042	1/4	3/8	23	22	10
176-1044	1/4	1/2	25	24	10
176-1045	3/8	1/2	27.5	24	10
176-1046	1/2	3/4	30	30	10
176-2136	M5	1/8	13	14	1

Male Plug (Parallel) with Hexagon Embedded and NBR O-Ring

- Minimum temperature - 20 °C
- Maximum temperature + 80 °C



Stock No.	A	B	L	D	CH	Pk
176-1048	1/8	6	8.5	14	5	10
176-1049	1/4	8	11	17	6	10
176-1050	3/8	9	12.5	20	8	10
176-1051	1/2	10	13.5	25	10	10

Male Plug (Parallel)

- All Fluids compatible Mechanical Resistance
- Silicon Free
- Maximum temperature + 300 °C
- Parallel gas in conformity with ISO 228 Class A.
- Can be also installed with a screwdriver



Stock No.	A	B	L	CH	Pack
176-1052	1/8	6.5	10	14	10
176-1053	1/4	9	13	17	10

Silencer

- Pressure 12 bar
- Minimum temperature - 10 °C
- Maximum temperature + 80 °C
- Filtration threshold 100 µm

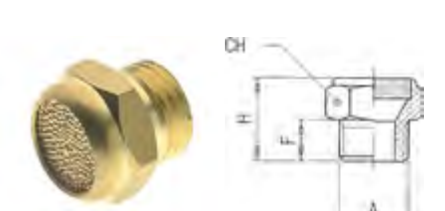

Stock No.	A	F	H	CH	dB*	Pk
176-2279	1/8	6	14	13	73	10
176-2280	1/4	7	17	16	74	10
176-2281	3/8	8	18	19	85	10
176-2282	1/2	10	20	24	89	10

Function Fittings

When specific pneumatic operations are required, RS PRO function fittings are designed to carry these out. Made from brass, stainless steel 316L, technopolymer and aluminium, they respond to the most extreme demands of pneumatics: flow controls, pressure regulators, unidirectional valves, block valves, check valves, quick exhaust valves, logic elements, slide valves, etc.

APPLICATIONS

- Pneumatic automation, robotics, handling
- Automotive process
- Large range
- Food processing
- Energy saving

MAIN ADVANTAGES

- Compact and sharp in pneumatic
- Limited pressure drop
- Easy to handle
- Function repeatability
- Range of materials
- Silicon free

Tube In-Line Needle Valve (Unidirectional Flow)

- Body made of techno-polymer material, with nickel-plated brass joints
- Outlet pressure range of 1 bar to 10 bar
- Operating temperature range of -20°C to +80°C

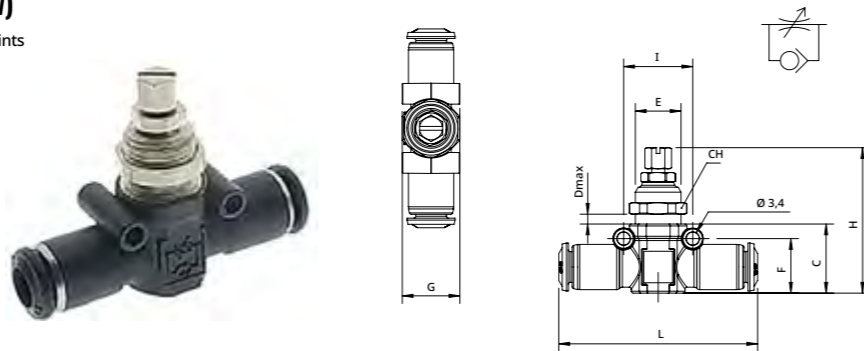

Stock No.	Tube	C	D	E	F	G	H	I	L	CH	Pack
176-1892	4	18	4	M12x1	14.5	15	37.5+43.5	18	52	14	10
176-1889	6	18	6	M12x1	14.5	15	37.5+43.5	18	52	14	10
176-1890	8	20	6.5	M14x1	16.5	17	39.5+45.5	20	58	16	10
176-1891	10	23.5	8	M16x1	19.5	19	47.5+53.5	22.5	67	18	10

Uni-Directional Flow Regulator

- Anodized aluminium body.
- Pressure Range: 1 bar (0.1 MPa) to 10 bar (1 MPa)
- Temperature Range: -20 °C to +80 °C
- Available in different sizes.

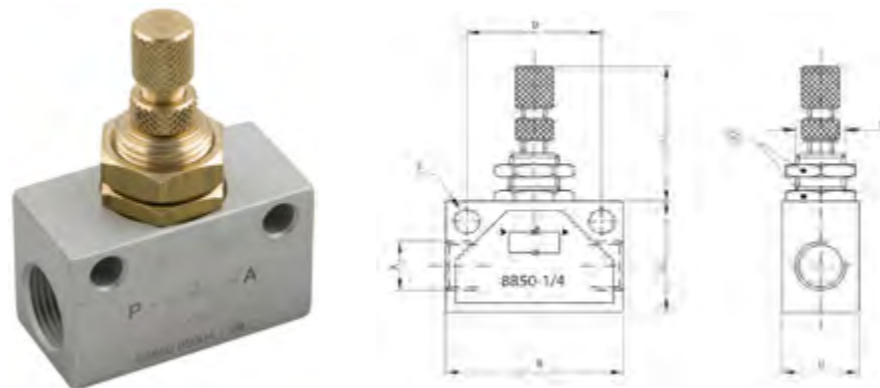

Stock No.	A	B	C	H	D	F	L	M	CH	Pack
176-1755	1/8	35	22	18	24.7	4.5	26-36	M12x0.75	15	10
176-1757	1/4	46	30	20	35	6.5	26-36	M12x0.75	15	10
176-1758	3/8	50	30	25	35	6.5	32-42	M18x1.5	22	10
176-1754	M5	25	15	12	18	4.5	20-27	M10x0.75	12	10

TUBING & AIR TOOLS

Supporting all pneumatic and some fluid applications, our range of RS PRO tubing is widely used across air brake, fuel and instrumentation applications and product line installations. Plus a wide range of air tools from blow guns to impact wrenches.

Nylon Tubing

- Flexible, durable, silicone-free Nylon tubing ideal for both pneumatic and fluid applications
- Ideal for low toxic, high temperature environments and applications involving food contact.
- Mirror smooth inner for improved flow
- Ideal for production lines (industrial and automotive) requiring long lengths and minimum wastage



Polyurethane Tubing

- Can be used with push-fit adaptors and has exceptional abrasion and kink resistance, making it suitable for use with a wide range of chemicals.
- Highly flexible, cut and abrasion resistant
- Silicone free
- Temperature range -50 to +55°C



Tube Cutter

- Heat-treated stainless steel durable blade
- Compact and lightweight design is perfect for pocket size
- Comfortable grip zones for less user fatigue
- Will cut through most hoses of variable material up to 13mm



- 483-4914 Black, 2.5mm ID, 4mm OD, 30m
- 483-4936 Blue, 2.5mm ID, 4mm OD, 30m
- 483-4942 Yellow, 2.5mm ID, 4mm OD, 30m
- 483-4958 Black, 4mm ID, 6mm OD, 30m
- 483-4964 Green, 4mm ID, 6mm OD, 30m
- 483-4970 Blue, 4mm ID, 6mm OD, 30m
- 483-4986 Yellow, 4mm ID, 6mm OD, 30m
- 483-5018 Black, 5.5mm ID, 8mm OD, 30m
- 483-5030 Blue, 5.5mm ID, 8mm OD, 30m
- 483-5046 Yellow, 5.5mm ID, 8mm OD, 30m
- 483-5052 Black, 7mm ID, 10mm OD, 30m
- 483-5080 Blue, 7mm ID, 10mm OD, 30m
- 483-5103 Black, 8.5mm ID, 12mm OD, 30m
- 483-5541 Red, 2.5mm ID, 4mm OD, 30m
- 483-5585 Red, 5.5mm ID, 8mm OD, 30m
- 483-5608 Red, 7mm ID, 10mm OD, 30m

- 917-2365 Black, 2.5mm ID, 4mm OD, 30m
- 917-2369 Black, 4mm ID, 6mm OD, 30m
- 917-2378 Black, 5mm ID, 8mm OD, 30m
- 917-2375 Black, 9mm ID, 12mm OD, 30m
- 917-2400 Clear, 4mm ID, 6mm OD, 30m
- 917-2404 Clear, 5mm ID, 8mm OD, 30m
- 917-2413 Clear, 9mm ID, 12mm OD, 30m
- 917-2384 Blue, 2.5mm ID, 4mm OD, 30m
- 917-2387 Blue, 4mm ID, 6mm OD, 30m
- 917-2381 Blue, 5mm ID, 8mm OD, 30m
- 917-2390 Blue, 7.5mm ID, 10mm OD, 30m
- 917-2397 Blue, 9mm ID, 12mm OD, 30m
- 917-2422 Red, 4mm ID, 6mm OD, 30m
- 917-2426 Red, 5mm ID, 8mm OD, 30m
- 917-2435 Red, 7.5mm ID, 10mm OD, 30m
- 917-2438 Red, 9mm ID, 12mm OD, 30m
- 917-2441 Yellow, 4mm ID, 6mm OD, 30m
- 917-2444 Yellow, 5mm ID, 8mm OD, 30m
- 917-2410 Green, 4mm ID, 6mm OD, 30m

828-0223 Red, 13mm Max. Size Cut

Air Blow Gun

- You'd find an air gun such as this used in laboratories and manufacturing.
- 6mm bent pipe
- Operating temperature range from -20°C to +80°C



176-2230 Air Inlet BSP 1/4 in, 16 Bar Working Pressure, 6mm bent pipe

Air Impact Wrench

- Ergonomic design for comfort
- Comfortable holding during extended use
- Energy efficient motor for maximum performance
- Long Life
- Handle exhaust directs away from work Piece and operator
- Lightweight
- Reduced vibration
- Twin hammer impact mechanism



137-0876

Air Rivet Gun

- Aluminium construction, ergonomically designed, lightweight air riveter.
- Mechanism 1870 Traction Power
- Minimum hose size 10mm / 3/8in
- Sound level 76dBA
- Average air consumption 4cfm / 113 l/min
- Maximum permissible operating pressure : 90 psi (6.2 bar)



739-8427 1/4 in Air Inlet

Reversible Air Drill

- The Air Drill has a rear exhaust through handle
- Side-mounted forward/reverse shift
- The triple planetary gear system
- Jacobs Keyless Chuck for quick drill replacement inside the chuck and tighten the chuck around it by twisting
- The lightweight construction of 1.1 kg
- Sound of 87 dBA



739-8395

Pistol Air Screwdriver

- Pistol air screwdriver type with hex drive
- Drive size of 1/4 in
- Length of 215 mm
- Speed of 1800 rpm
- Vibration level of 0.08 m/s²



137-0887 BSP 1/4 in Air Inlet

Venturi Air Gun

- Venturi action nozzle multiplies air volume output, and makes gun completely safe, because - unlike conventional units - output air flows around the unit and not through it
- Manufactured from aluminium for longevity



488-5568 12bar, 1/4in BSP Inlet

Air Body Saw

- Aluminium
- This equipment has a free speed of 9000 RPM (revolutions per minute) and it creates 87 dBA (decibels) of sound.
- It requires a minimum hose size of 10 mm or 3/8 inch.
- The saw offers high performance, with a 16 SWG (British standard wire gauge) cutting capacity.



739-8433 Air Inlet BSP 1/4 in, 1.2mm Cutting Capacity, 280L/min Airflow

Angle Air Grinder

- 254 mm long with side handle for operator comfort.
- Four cutting disks (100 mm) included
- Reasonably lightweight Grinder of 2 kg with minimum hose size of 10 mm
- Our Air Grinder conforms to directive 2006/42/EEC and the standards of EN 792-6 ISO 28927



739-8389

Straight Air Die Grinder

- Straight position type of grinder
- 6 mm 3-Piece design collet
- Rear exhaust through handle
- High velocity, low vibration (5.4m/s²)
- Average air consumption 3cfm / 85 l/min
- Safety throttle lever
- Positive throttle action
- Sound level 93dBA



739-8398 6mm

Air Ratchet

- The ball-type retainer makes switching between different sockets and accessories straightforward.
- Weighs 1.2 kg and has a length of 266 mm, so you can use it even in hard-to-reach spaces.
- Ideally suited for use with radiators, fuel pumps and small engine parts.
- Average air consumption of 101 litres / 3.6 cubic feet per minute



739-8382 3/8 in Air Inlet

739-8385 1/2 in Air Inlet

Air Body Saw

- Low vibration
- Lightweight
- High cutting capacity
- Adjustable rear exhaust



137-0891 Air Inlet BSP 1/4 in, 1.2mm Cutting Capacity, 35.1L/min Airflow

Air Operated Grease Gun

- Accepts standard 400cc cartridges or can be bulk filled
- Allows wide angle operation in a narrow space
- Supplied complete with one rigid and one flexible nozzle
- Working Pressure 30-150 psi
- 1/4in BSP Inlet
- Weight 1.5 kg



809-015 Air Inlet BSP 1/4 in, Working Pressure 30-150psi

Air Shear

- Touch-sensitive trigger for easy operation
- Blades reach 2000 RPM for swift, clean cuts
- Ergonomic aluminum handle for comfortable one-handed use
- Ideal for 18-gauge steel in auto shops
- Corded with a length of 210mm



739-8420

Air Ratchet

- Fast run down speed
- Lightweight
- Reduced Vibration
- Easy speed control
- Length 293mm
- Average Air Consumption 73.6L/min



137-0882 Air Inlet BSP 1/4 in, 3/8 in Driver Size

Air Screwdriver

- Maximum torque 17Nm
- Rear exhaust through handle
- Spring compression determines torque setting
- Sensitive trigger mechanism
- Minimum hose size 10mm
- Sound level 86dBA
- Average Air Consumption 4cfm / 113 l/min



739-8411

Straight Air Die Grinder

- Rear exhaust through handle
- High velocity, low vibration (5.4m/s²)
- Average air consumption 3cfm / 85 l/min
- Safety throttle lever
- Positive throttle action
- Min Hose Size 10mm
- Sound level 93dBA



739-8391 1/4 in Air Inlet

Orbital Sander

- Easy-to-use option for quickly smoothing out surfaces.
- Features a built-in speed regulator for optimised control and produces low levels of noise for a quieter working environment.
- Insulated handle and motor housing to ensure safety from electrical hazards.
- Weight 710g



137-0895

Air Hammer

- Air hammer with 2,900 bpm impact rate
- Suitable for cutting, carving, and grooving wood, stone, metal
- Includes five different chisels and a scaler with 19 needles (3mm Dia.)
- Features reduced vibration and swivel inlet
- Unique balanced design for ease of use
- Equipped with a quick-change retainer



137-0893 Air Hammer with 5 x chisels, 1 x scaler with 19 needles (3mm Dia.)

Angled Air Drill

- Angle head for easy access
- Rear exhaust through handle
- Jacobs Keyless Chuck for quick drill replacement inside the chuck and tighten the chuck around it by twisting
- Powerful Air Motor
- Positive trigger action
- Sound of 87 dBA
- The lightweight construction of 0.9 kg
- Recommended lubrications 10 Weight SAE Oil



739-8405

COMPRESSED AIR TREATMENT

RS PRO provides a comprehensive range of compressed air treatment products, including air filters, regulators, lubricators, and dryers, ensuring clean, dry, and regulated compressed air for various industrial applications.

Air Filter

- Semiautomatic manual filters for pneumatic networks.
- Modular system allows individual combinations with other RS PRO air treatment components by using RS PRO air distributors and connection plates.
- Filtration Grade: 20µm
- Connection plate FIL2 Size 176-1729



Stock No.	Size	Port Connection	Filtration Grade	Max Flow Rate	Exhaust
176-1719	FIL 1	G 1/4	20 µm	1900 NI/min	S/M
176-1720	FIL 2	G 3/8	20 µm	3750 NI/min	S/M
176-1721	FIL 2	G 1/2	20 µm	3750 NI/min	S/M
176-1722	FIL 3	G 3/4	20 µm	6250 NI/min	S/M

Lubricator

- Manual lubricators for pneumatic networks.
- The modular system allows individual combinations with other RS Pro air treatment components by using RS Pro air distributors and connection plates.



Stock No.	Size	Port Connection	Flow Rate	Oil Loading System
176-1715	LUB 1	G 1/4	2600 NI/min	M
176-1746	LUB 2	G 3/8	5600 NI/min	M
176-1745	LUB 2	G 1/2	5600 NI/min	M
176-1744	LUB 3	G 3/4	8200 NI/min	M

Regulator

- Lightweight yet durable thanks to its technopolymer construction.
- Fitted with coalescing filters, so it doubles as a filtration system that keeps the air free of impurities or particles.



Stock No.	Size	Port Connection	Regulation	Max Flow Rate
176-1723	REG 1	G 1/4	0 ÷ 8 bar	2050 NI/min
176-1724	REG 2	G 3/8	0 ÷ 8 bar	3200 NI/min
176-1725	REG 2	G 1/2	0 ÷ 8 bar	3200 NI/min
176-1726	REG 3	G 3/4	0 ÷ 8 bar	6200 NI/min

Manometer Back Entry Pressure Gauge

- Manometer-type analogue positive pressure gauge
- Pressure measurement range of 0 bar to 10 bar
- Minimum operating temperature of -20°C
- Maximum operating temperature of +60°C
- Modularity
- Sharp and reliable regulation
- High Flow
- Coalescing Filters
- Silicon Fre



Stock No.	Outside Diameter	Port Connection	Pressure Range
176-1718	40mm	G 1/8	0 bar to 10 bar

Combination Units

Combined FR or FR+L units help with installation of the complete assembly to cleanse and rid the air of pollutants.



APPLICATIONS

- Modularity
- High flow rate
- Robust
- Light weight
- Silicon Free

MAIN ADVANTAGES

- Pneumatic automation
- Compressed air circuits
- Compressors
- Compressed air pipeline

Filter Regulator

- The modular system allows individual combinations with other RS PRO air treatment components by using RS PRO air distributors and connection plates.
- Filtration Grade: 20µm
- Regulation Range: 0-8bar



Stock No.	Size	Thread	Filtration	Regulation	Flow Rate	Exhaust
176-1727	FIL 1	1/4	20 µm	0 ÷ 8 bar	1650 NI/min	1650 NI/min
176-1729	FIL 2	3/8	20 µm	0 ÷ 8 bar	3000 NI/min	3000 NI/min
176-1738	FIL 2	1/2	20 µm	0 ÷ 8 bar	3000 NI/min	3000 NI/min
176-1741	FIL 3	3/4	20 µm	0 ÷ 8 bar	4500 NI/min	4500 NI/min

Connection Plate

- Connection plates for RS PRO Filter, Regulator and Lubricator components



176-1732

V + FR + L

- V+FRL combinations for pneumatic networks with semiautomatic manual condensate exhaust system.
- Filtration Grade: 20µm
- Regulation Range: 0-8bar
- Manual shut off valve included
- Lubricator with manual oil loading system



Stock No.	Size	Thread	Filtration Size	Regulation	Flow Rate
176-1748	V+FR+L 1	1/4	20 µm	0 ÷ 8 bar	800 NI/min
176-1736	V+FR+L 2	1/2	20 µm	0 ÷ 8 bar	2100 NI/min
176-1735	V+FR+L 3	3/4	20 µm	0 ÷ 8 bar	3500 NI/min



If you'd like to start exploring the RS PRO now, head over to our website browse the vast range.

rspro.com

CONTACT US



Singapore

133 Cecil Street
#14 - 01
Keck Seng Tower
Singapore 069535

T +65 6865 3400

E Orders.SA@rs.rsgroup.com



Philippines

21/F Multinational
Bancorporation Centre
6805 Ayala Avenue
Makati City Philippines 1226

T +632 8888 4030

E Orders.PH@rs.rsgroup.com



Malaysia

Suite 12-9, The Office Club,
Level 12, Menara Mudajaya,
No 12A, Jalan PJU 7/3,
Mutiara Damansara,
47810 Petaling Jaya, Selangor,
Malaysia

T +603 5021 5888

E Orders.MY@rs.rsgroup.com



Thailand

50 GMM Grammy Place, 19th Floor,
Unit 1901-1904, Sukhumvit 21 Road
(Asoke), Klongtoey Nua, Wattana,
Bangkok, Thailand 10110

T +66 2 648 6868

E Orders.TH@rs.rsgroup.com



Vietnam

T +65 6865 3433

E Orders.VN@rs.rsgroup.com



Indonesia

T +65 6865 3433

E Orders.ID@rs.rsgroup.com