



ELECTRICAL CONTROL PANEL RANGE

Discover RS PRO, the value alternative at the right price.

Find single components to enclosures - and everything from power supplies to push buttons - RS PRO offers the parts you need to build, maintain or level-up your industrial control panels.



YOUR SMART CHOICE FOR CONTROL PANELS

Discover RS PRO, the own brand, of RS, and our wide range of quality products across all industries. Our value alternative at the right price.

RS PRO offers customers with one brand that gives huge choice and solutions, proven quality and prices that can be trusted.

The wide range of electrical products from RS PRO covers all you need to build industrial control panels and beyond from quality products you can trust.

Since 1937, RS PRO has had a passion for industrial parts. More importantly, we believe that every part matters, because the quality of your applications will always be linked to the quality of every part going into them.

This is why we rigorously test every part against demanding industry standards to gain the RS PRO Seal of Approval.

THE WINNING COMBINATION FOR YOUR INDUSTRIAL SUPPLIES



Our products are tested for great performance and only awarded after a rigorous quality process to demanding international standards.



A combination of quality and choice, and sustainable product solutions, with competitive pricing against branded alternatives.



Over 80,000 products available with a low return rate of less than 0.02%.



Our products come with a 3-year warranty, where applicable.



TECHNICAL REFERENCE CHARTS 6

Ingress Protection (IP) Ratings	6
Wire Gauge Size Chart	7
3 Phase Motor Starting Currents	7

CONTROL & SIGNALLING DEVICES 8

Plastic Modular Series - Non-Illuminated Heads	9
Plastic Modular Series - Illuminated Heads	10
Plastic Modular Series - Contact & Light Blocks	11
Plastic Monoblock Series	12
Metal Modular Series	14
Push Button Enclosures & Legend Plates	15
Automation Signalling & Safety	16
Switches	17

PROGRAMMABLE CONTROL DEVICES 18

Programmable Control Devices	19
Temperature Controllers	20

PROCESS CONTROL & PROTECTION 22

Relays	24
Motor Control & Protection	26

CONTROL CABINET WIRING 28

Wire Cutters & Strippers	29
Cable Markers	30
Tapes and Heat-Shrinks	31
Crimp Terminals & Tools	32
Bootlace Ferrules & Crimping Pliers	33
Cable Ties	34

WALL BOXES & ACCESSORIES 36

Wallboxes & Accessories	37
Isolators & Disconnectors	38
Axial Fans	39
Cable Glands	40
Cable Tray, Trunking & Protectors	42
Cable Conduit	43
Terminal Blocks & Accessories	44
DIN Rail Terminal Blocks & Accessories	46
Fuses & Fuse Holders	48
Cable Conduit	49

FACTORY AUTOMATION SENSORS 50

Factory Automation Sensors & Accessories	51
Photoelectric Sensors - Barrel	52
Proximity Photoelectric Sensors - Block	54
Proximity Capacitive Sensors	56
Accessories & Related Products	58

TOOLS & CONSUMABLES 59

Tool Kits	61
Insulated Tools	64
Pliers	68
Spanners & Sockets	70
Power Tool Accessories & Drill Bits	72
Electrical Test Equipment	74
Linear Measurement & Cutting Tools	76
Tool & Consumables Storage	78
Tapes	80

PPE & SITE SAFETY 82

Site Safety & Security	83
------------------------	----

To view our latest prices, charges and full terms see RS Conditions of Sale as set out online at au.rs-online.com and nz.rs-online.com.

Published by: RS Components Pty Ltd

Registered office:

25 Pavesi Street Smithfield NSW 2164 Australia

RS are trademarks of RS Components Limited. An RS Group PLC Company.

EVERYTHING YOU NEED TO BUILD AND MAINTAIN YOUR PANEL

RS PRO offering for panel building allow you to build and maintain you panel according to your needs, with high quality components and a wide choice to meet industrial requirements.

INSIDE THE PANEL

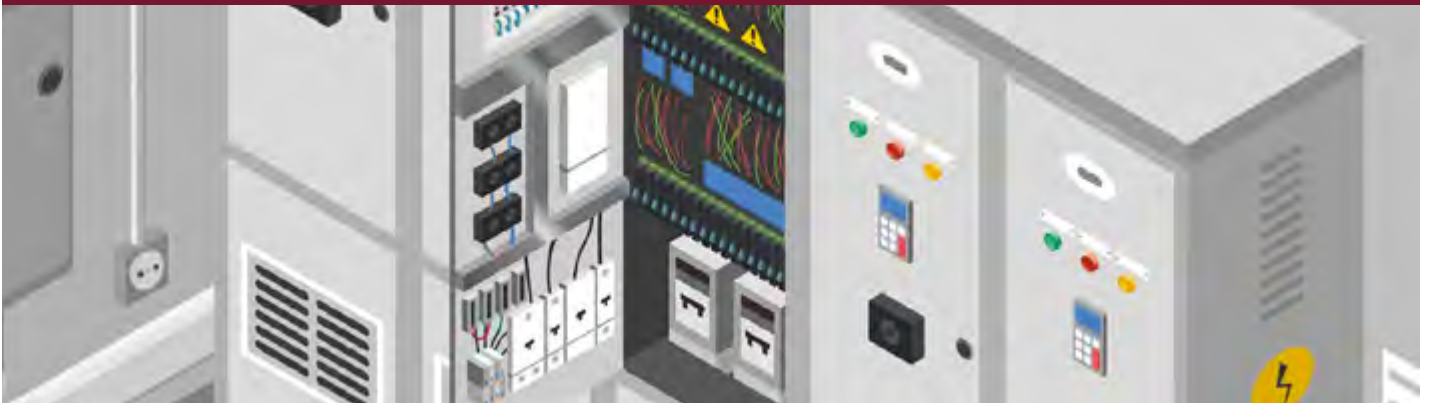

DIN Rail Power Supply



Ethernet Switches



Relays



- General purpose
- Solid State
- Interface Module
- Control Relay

Timers



Time Switches



Terminal Blocks



- DIN Rail Terminal Blocks
- Distribution Blocks
- DIN Rail Terminal Accessories
- Terminal Block Accessories

Surge Suppression



Enclosure



- Enclosure Heaters
- Wall Boxes
- DIN Rail Enclosure
- Enclosure Accessories
- DIN Rails

Cable & Wires



- Hookup & Equipment Wire
- Coaxial Cables
- Multicore Cables
- Network & Communication Cables
- Ribbon & Flat Cables
- Slotted Panel Trunking

Axial Fans



Related Products

CABLE GLANDS, STRAIN RELIEF & GROMMETS



CABLE TIES



CIRCULAR CONNECTORS



HEAT-SHRINK & COLD-SHRINK SLEEVES



WIRE TERMINAL & SPLICES



CABLE, CONNECTOR & CRIMPING TOOLS



TOOL KITS



ELECTRICAL TEST EQUIPMENT



DIGITAL MULTIMETERS



WIRE STRIPPERS



CABLE MARKING



THERMAL IMAGING CAMERAS



OUTSIDE THE PANEL



<p>Switches</p> <ul style="list-style-type: none"> Industrial Switches Industrial Push Buttons Push Button Switches Rocker Switches Key Switches Toggle Switches 	<p>Counters</p>	<p>Ammeters</p>	<p>Voltmeters</p>	<p>Energy Meters</p>
<p>Multi Function Panel Meters</p>	<p>Temperature Controllers</p>	<p>Sounders & Beacons</p>	<p>Indicators</p>	<p>HMI</p>
<p>Thermostats</p>	<p>Fan Filters</p>			

Related Products

<p>CABLE GLANDS, STRAIN RELIEF & GROMMETS</p>	<p>INDUSTRIAL POWER CONNECTORS</p>	<p>HEAVY DUTY CONNECTORS</p>	<p>CABLE, CONNECTOR & CRIMPING TOOLS</p>	<p>TOOL KITS</p>	<p>ELECTRICAL TEST EQUIPMENT</p>
<p>INDUSTRIAL EXTENSION LEADS</p>	<p>DIGITAL MULTIMETERS</p>	<p>INDUSTRIAL AUTOMATION CABLE ASSEMBLIES</p>	<p>EXTENSION LEADS & CABLE REELS</p>	<p>LAN CABLE ASSEMBLIES</p>	<p>POWER CABLE ASSEMBLIES</p>

TECHNICAL REFERENCE CHARTS

INGRESS PROTECTION (IP) RATINGS

The Ingress Protection (IP) rating system is an internationally recognized scale that relates to proven protection against environmental factors such as liquids and solids.

Ingress protection ratings can be identified by the letters IP, followed by two numbers. These numbers define the amount of protection a digital scale has against specified elements and its ability to resist foreign matter that could otherwise get inside the product and cause it to fail.

1ST DIGIT = Degree of protection against solid objects

No Protection

0

Protected against solid objects greater than 50mm.

1

Protected against solid objects greater than 12.5mm.

2

Protected against solid objects greater than 2.5mm.

3

Protected against solid objects greater than 1.0mm.

4

Protected against dust that could cause sufficient harm.

5

Protected against all dust.

6

2ND DIGIT = Degree of protection against water

No Protection

0

Protected against drops of water.

1

Protected against drops of water at a 15 degree angle.

2

Protected against water spray at a 60 degree angle.

3

Protected against water spray splashing from any angle.

4

Protected against water jets from any angle.

5

Protected against powerful jets of water or heavy seas.

6

Protected against temporary immersion in water (30 minutes at 1M).

7

Protected against the effects of permanent immersion in water (up to 5M).

8

Protected against close-range high pressure, high temperature spray downs (80 degC water at 80-100bar for 30sec x 4 angles.

9K

Example:

IP

4

4

Protected against solid objects greater than 1.0mm.

Protected against water spray splashing from any angle.

WIRE GAUGE SIZE CHART

American wire gauge (AWG) is a standardized wire gauge system for the diameters of round, solid, nonferrous, electrically conducting wire. The larger the AWG number or wire gauge, the smaller the physical size of the wire. The smallest AWG size is 40 and the largest is 0000 (4/0). AWG general rules of thumb - for every 6 gauge decrease, the wire diameter doubles and for every 3 gauge decrease, the cross sectional area doubles.

AWG/KCMIL No.	Diameter section (mm)	Cross geometric (mm ²)	Conductor resistance (Ω/km)
500	17.96	253	0.07
350	15.03	177	0.1
250	12.7	127	0.14
(4/0)	11.68	107.2	0.18
(3/0)	10.4	85	0.23
(2/0)	9.27	67.5	0.29
(1/0)	8.25	53.5	0.37
1	7.35	42.4	0.47
2	6.54	33.6	0.57
4	5.19	21.2	0.91
6	4.12	13.3	1.44
8	3.26	8.37	2.36
10	2.59	5.26	3.64
12	2.05	3.31	5.41
14	1.63	2.08	8.79
16	1.29	1.31	14.7
18	1,024	0.823	23
20	0.813	0.519	34.5
22	0.643	0.324	54.8
24	0.511	0.205	89.2
26	0.405	0.128	146
28	0.32	0.0804	232
30	0.255	0.0507	350
32	0.203	0.0324	578
34	0.16	0.02	899
36	0.127	0.0127	1426
38	0.102	0.00811	2255
40	0.079	0.00487	3802
42	0.064	0.00317	5842
44	0.051	0.00203	9123

3 PHASE MOTOR STARTING CURRENTS

Calculate starting, running & full-load current of 3 phase AC induction motor.

Motor Rating		Power Factor	Efficiency %	230V			400V		
				Rated motor current*	230V Fuse for DOL starting	230V Fuse for star delta starting	Rated motor current	400V Fuse for DOL starting	400V Fuse for star delta starting
kW	HP	cosφ	%	A	A	A	A	A	A
0.37	0.5	0.72	66	2	6	4	1.1	4	2
0.55	0.7	0.75	69	2.7	10	4	1.5	4	2
0.75	1	0.79	74	3.2	10	4	1.9	6	4
1.1	1.5	0.81	74	4.6	10	6	2.6	6	4
1.5	2	0.81	74	6.3	16	10	3.6	6	4
2.2	2.9	0.81	78	8.7	20	10	5	10	6
3	4	0.82	80	11.5	25	16	6.6	16	10
4	5.4	0.82	83	14.8	32	16	8.5	20	10
5.5	7.4	0.82	86	19.6	32	25	11.3	25	16
7.5	10.1	0.82	87	26.4	50	32	15.2	32	16
11	14.7	0.84	87	38	80	40	21.7	40	25
15	20.1	0.84	88	51	100	63	29.3	63	32
18.5	24.8	0.84	88	63	125	80	36	63	40
22	29.5	0.84	92	71	125	80	41	80	50
30	40.2	0.85	92	96	200	100	55	100	63

CONTROL & SIGNALLING DEVICES

From push buttons to emergency stop buttons, from key-operated to panel-mount selector switches - we have extended our offering to meet your every need.

22mm Control & Signalling Devices

The new RS PRO range of 22mm push buttons, indicator lights and switches are the perfect solution for OEMs and panel builders in almost every industry. The RS PRO offer consists of modular variants in metal or plastic which allow customers to flexibly configure their control device of choice. In addition to the modular system, RS PRO also offer complete mono-style types which allow easy stock management and installation. All products are fully sealed with an IP65 rating to protect sensitive components inside the panel from ingress of dust and water.

All products in the following guide are ROHS compliant, UL listed and conform to CE IEC and several others. The full range is tested in the RS PRO laboratory to different electrical and mechanical endurance tests as per different global electrical standards.

The manufacturing sites of our RS PRO push buttons have adopted green practices which have helped to reduce the wastage of plastic and other harmful products. They have also incorporated sustainable practices to reduce the consumption of electricity. RS PRO puts the highest focus across all our manufacturers with the conscious effort to reduce our carbon footprint.

PLASTIC MODULAR SERIES

- Non-Illuminated Heads - Push Button, Selector Switch & Key Switch
- Illuminated Heads - Push Button, Selector Switch & Indicator
- Light Blocks
- Contact Blocks

PLASTIC MONOBLOCK SERIES

- Non-Illuminated Heads - Push Button, Selector Switch & Key Switch

METAL MODULAR SERIES

- Non-Illuminated Heads - Push Button, Selector Switch & Key Switch
- Contact Blocks

ACCESSORIES

- Enclosures
- Legend Plates

Double Push Button Head

- Double push button heads for use with the RS PRO modular plastic push button series.
- Robust design, illuminated and non-illuminated versions with modern silver coloured bezel.
- Simple installation via standard lock nut.

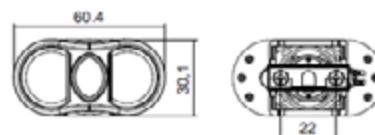
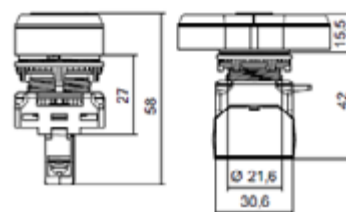

Stock No. 

Colour

188-1200



Green / Red

Push Button Heads

- Non-illuminated raised and flush push button heads for use with the RS PRO modular plastic push button series. Robust designs in a variety of colours with modern silver coloured bezel.
- Simple installation via standard lock nut.
- Spring Return head
- Contact block mounting clip included
- Stackable design for contact blocks (max 6)
- Mechanical life more than 1 million uses

IP65 RATED

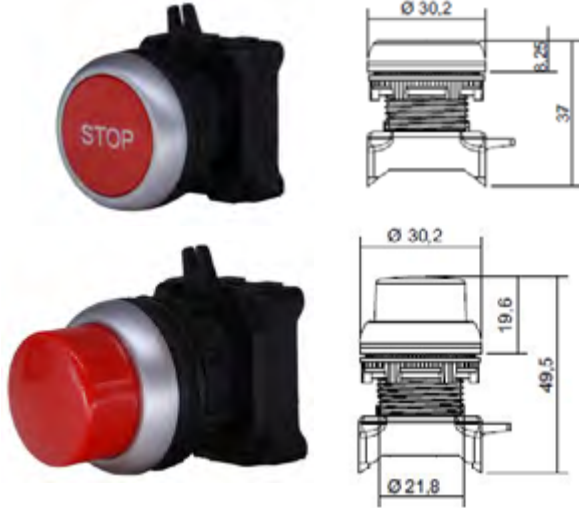

Stock No.	Style	Colour	Print
188-1129	Raised		Red N/A
188-1130	Raised		Green N/A
188-1122	Flush		Blue N/A
188-1123	Flush		Red N/A
188-1124	Flush		Green N/A
188-1126	Flush		Yellow N/A
188-1127	Flush		Black N/A
188-1128	Flush		White N/A
188-1132	Flush		Red O
188-1133	Flush		Green
188-1134	Flush		Red STOP
188-1137	Flush		Blue RESET
188-1138	Flush		Black ↑
188-1139	Flush		Black ↓
188-1140	Flush		Green START

Selector Switch Heads

- 2 or 3 position selector switch heads for use with the RS PRO modular plastic push button series.
- Robust design with modern aesthetics delivered via silver coloured bezel.
- Simple installation via standard lock nut.
- Latching and Spring return head options.
- Contact block mounting clip included.
- Stackable design for contact blocks (max 6)
- Mechanical life more than 1 million uses

IP65 RATED



Stock No.	Positions	Throw Angle	Switch Actuation	Actuation Diagram
188-1148	2 Position	0° – 30°	Return	
188-1151	3 Position	-45° – 45°	Latching	
188-1152	3 Position	-45° – 45°	Return	
188-1146	2 Position	0° – 30°	Latching	

Key Switch Heads

- 2 and 3 position key switch heads for use with the RS PRO modular plastic push button series.
- Robust design in black with modern silver coloured bezel. Plastic body with metal look.
- Simple installation via standard lock nut.
- Latching and Spring return head options
- Contact block mounting clip included
- Stackable design for contact blocks (max 6)
- All key switches from the RS PRO plastic modular series are supplied with alike keys
- Keys are removable at 0 - position

IP65 RATED

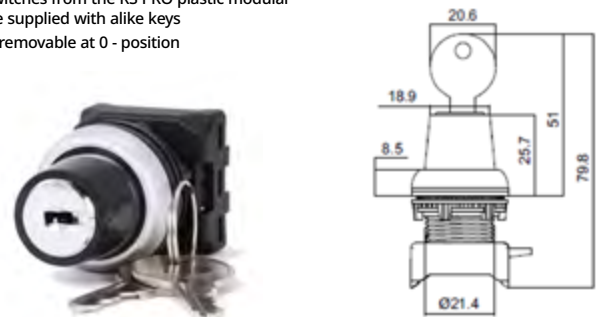

Stock No.	Positions	Throw Angle	Switch Actuation	Actuation Diagram
188-1149	2 Position	0° – 30°	Latching	
188-1150	2 Position	0° – 30°	Return	
188-1154	3 Position	-45° – 45°	Latching	
188-1155	3 Position	-45° – 45°	Return	

Push Button Heads

- Illuminated flush push button heads for use with the RS PRO modular plastic push button series. Robust designs in a variety of colours with modern silver coloured bezel.
- Simple installation via standard lock nut.
- Spring Return head
- Contact block mounting clip included
- Stackable design for contact blocks (max 6)
- Mechanical life more than 1 million uses

IP65 RATED



Stock No.	Style	Colour
188-1141	Flush	Blue
188-1142	Flush	Red
188-1143	Flush	Green
188-1144	Flush	Yellow
188-1145	Flush	White

Indicator Light Heads

- Indicator light heads for use with the RS PRO modular plastic push button series.
- Simple installation via standard lock nut.
- Panel mounted
- Plastic body

IP65 RATED



Stock No.	Style	Cut Out Ø	Colour
188-1201	Pilot Light	22.5mm	Red
188-1202	Pilot Light	22.5mm	Blue
188-1203	Pilot Light	22.5mm	White
188-1205	Pilot Light	22.5mm	Yellow
188-1206	Pilot Light	22.5mm	Green
188-1207	Pilot Light	22.5mm	Orange

Illuminated Selector Switch Heads

- Illuminated 2 or 3 position selector switch heads for use with the RS PRO modular plastic push button series.
- Robust design in Green, Red and Amber with modern silver coloured bezel.
- Simple installation via standard lock nut.
- Latching and Spring return head options
- Contact block mounting clip included
- Stackable design for contact blocks (max 6)

IP65 RATED



Stock No.	Colour	Positions	Throw Angle	Switch Actuation	Actuation Diagram
188-1156	Green	2 Position	0° - 30°	Latching	
188-1157	Green	2 Position	0° - 30°	Return	
188-1158	Red	2 Position	0° - 30°	Latching	
188-1159	Red	2 Position	0° - 30°	Return	
188-1160	Orange	2 Position	0° - 30°	Latching	
188-1161	Orange	2 Position	0° - 30°	Return	
188-1162	Green	3 Position	30° - 30°	Latching	
188-1163	Green	3 Position	30° - 30°	Return	
188-1164	Green	3 Position	30° - 30°	Right Return	
188-1165	Green	3 Position	30° - 30°	Left Return	
188-1166	Red	3 Position	30° - 30°	Latching	
188-1167	Red	3 Position	30° - 30°	Return	

Double Push Button Head

- Double push button heads for use with the RS PRO modular plastic push button series.
- Robust design, illuminated and non-illuminated versions with modern silver coloured bezel.
- Simple installation via standard lock nut.



Stock No.	Colour
188-1199	Green / Red

Contact Blocks

- Compact for space saving
- Screw and spring terminal versions available
- Stackable design for contact blocks (max 6)
- Mechanical life more than 1 million uses
- Spring return actuation
- Clip mounting type

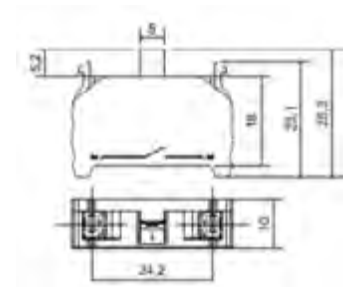

Stock No.	Actuation	Terminal	Contacts	Switching Capacity	Mounting Type
188-1168	Spring Return	Screw	NO	230V AC / 6A or 24V DC / 1.5V	Clip
188-1169	Spring Return	Screw	NC	230V AC / 6A or 24V DC / 1.5V	Clip

Light Blocks

- LED Light blocks for use with the RS PRO modular plastic push button series (Pilot Lights and Illuminated Push Buttons).
- Simple installation via clip, various voltage ratings available.
- Side view SMD LED technology
- 0.1 million burning hours
- Operating frequency: 50/60Hz
- Operating temp: -25°C - 65°C
- Wire termination capacity: 0.5mm², 1.5 - 2.5mm²
- Terminal torque: 0.8Nm
- Surge test: 2KV
- HV Test for 60 sec: 1.5KV

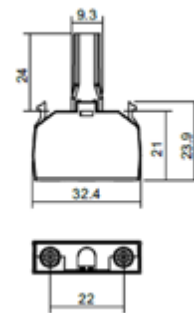

**IP20
RATED**

Stock No.	Colour	Voltage
188-1172	Red	12V AC/DC
188-1173	Blue	12V AC/DC
188-1174	White	12V AC/DC
188-1176	Yellow	12V AC/DC
188-1177	Green	12V AC/DC
188-1178	Amber	12V AC/DC
188-1179	Red	24V AC/DC
188-1180	Blue	24V AC/DC
188-1182	White	24V AC/DC
188-1183	Yellow	24V AC/DC
188-1184	Green	24V AC/DC
188-1185	Amber	24V AC/DC

Stock No.	Colour	Voltage
188-1186	Red	110V AC
188-1187	Blue	110V AC
188-1188	White	110V AC
188-1189	Yellow	110V AC
188-1190	Green	110V AC
188-1191	Amber	110V AC
188-1192	Red	240V AC
188-1193	Blue	240V AC
188-1194	White	240V AC
188-1195	Yellow	240V AC
188-1196	Green	240V AC
188-1198	Amber	240V AC

Flush Push Buttons

- Non-illuminated push buttons in mono-block style.
- Complete units available in various colours and contact configurations.
- Robust design in green, red, blue and amber and black with modern silver coloured bezel.
- Simple installation via standard lock nut.
- Spring return head
- Mechanical life more than 1 million uses

**IP65
RATED**

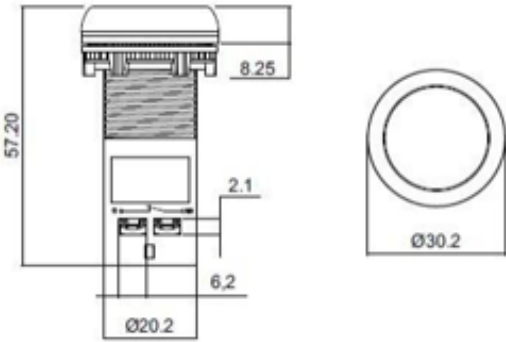

Stock No.	Style	Colour	Contact
145-0616	Flush	Green	2NO
145-0617	Flush	Yellow	2NO
145-0618	Flush	Black	2NO
145-0619	Flush	Blue	2NO
145-0621	Flush	Red	2NC
145-0607	Flush	Green	1NO
145-0609	Flush	Red	1NC
145-0610	Flush	Amber	1NO
145-0612	Flush	Black	1NO
145-0613	Flush	Blue	1NO
145-0611	Flush	Red	1NO + 1NC
145-0615	Flush	Green	1NO + 1NC

LED Indicators

- LED Indicators with multi-chip technology providing a bright and even colour with lower power consumption
- 22mm dia cutout with a choice of 12/24/230V operation - AC or DC
- Front panel protected to IP40 and have an operational life of 30,000 hours
- Built in Test Circuit allows remote illumination of all indicators in a panel for diagnostic purposes

**IP65
RATED**

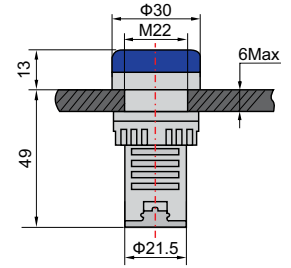

Stock No.	Colour	Voltage
909-2496	Blue	110V
909-2483	Blue	12V
909-2499	Blue	230V
909-2487	Blue	24V
909-2506	Green	110V
909-2493	Green	12V
909-2500	Green	230V
909-2503	Green	24V
909-2516	Red	110V
909-2519	Red	12V
909-2525	Red	230V
909-2512	Red	24V
909-2531	White	110V
909-2528	White	12V
909-2534	White	230V
909-2522	White	24V
909-2540	Yellow	110V
909-2538	Yellow	12V
909-2544	Yellow	230V
909-2547	Yellow	24V

Key Switches

- Non-illuminated key switches in mono-block style. Complete units available in various colours and contact configurations. Robust design with modern silver coloured bezel. Simple installation via standard lock nut.
- Spring return or latching head
- Complete units
- Mechanical life more than 1 million uses
- All key switches from the RS PRO plastic modular series are supplied with alike keys
- Keys are removable at 0 - position

IP65 RATED

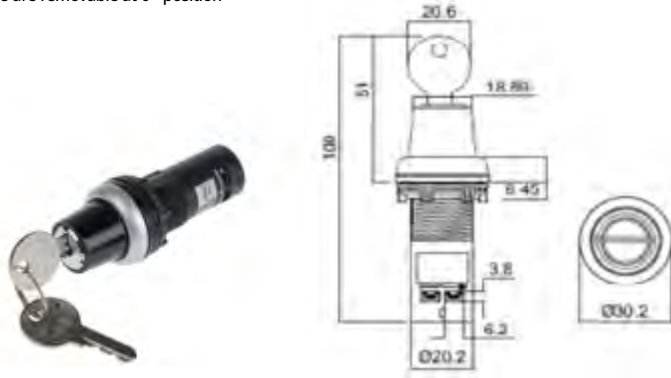

Selector Switches

- Non-illuminated selector switches in mono-block style.
- Complete units available in various positions and contact configurations.
- Robust design with modern silver coloured bezel.
- Simple installation via standard lock nut.
- Spring return head
- Mechanical life more than 1 million uses

IP65 RATED



Stock No.	Contact	Positions	Spring Return	Actuation Diagram
145-0626	1NO + 1NC	2 Position	None	
145-0627	1NO + 1NC	2 Position	From Right	
145-0628	1NO + 1NC	3 Position	None	
145-0629	1NO + 1NC	3 Position	From Left and Right	

Stock No.	Contact	Positions	Spring Return	Actuation Diagram
145-0622	1NO + 1NC	2 Position	None	
145-0623	1NO + 1NC	2 Position	From Right	
145-0624	1NO + 1NC	3 Position	None	
145-0625	1NO + 1NC	3 Position	From Left and Right	

LED Indicators with Sounder

- LED Indicators with multi-chip technology providing a bright and even colour with lower power consumption
- 22mm dia cutout with a choice of 12/24/230V operation - AC or DC
- Combined audible and visual warning via sounder output - 80dB
- IP30 front panel protection

IP30 RATED

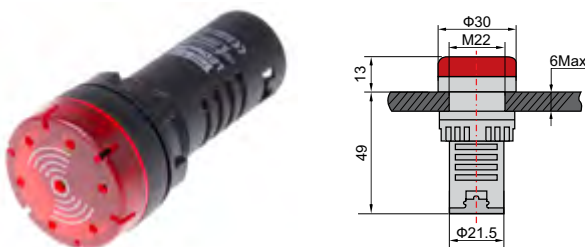

Pulsing Sounder

- 22mm pulsing audible signal, perfect for use in alarm circuits
- IP30 front panel protection
- All voltages offer AC or DC supply operation

IP30 RATED

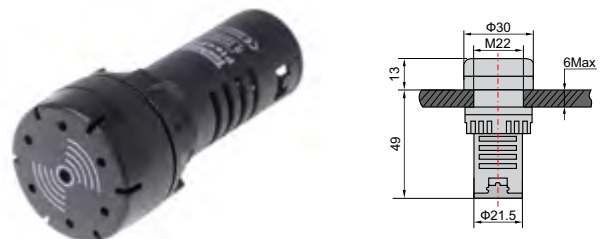

Stock No.	Colour	Voltage
909-2550	Red	110V
909-2553	Red	12V
909-2569	Red	230V
909-2556	Red	24V

Stock No.	Colour	Voltage
909-2562	Black	12Vac/dc
909-2566	Black	24Vac/dc
909-2575	Black	110/120V
909-2578	Black	230Vac

Flush Push Button Heads

- Non-illuminated flush and raised push button heads for use with the RS PRO modular metal push button series.
- Robust designs in a variety of colours with modern metal bezel.
- Simple installation via clamp screws.
- 22mm mounting diameter
- 29mm head diameter
- Contact block mounting collar included
- Spring return head

**IP65
RATED**



Stock No.	Style	Colour
205-2353	Flush	Blue
205-2357	Flush	Yellow
205-2354	Flush	Red
205-2355	Flush	Green
205-2358	Flush	Black
205-2359	Flush	White
205-2360	Raised	Red
205-2361	Raised	Green

Selector Switch Heads

- 2 or 3 position selector switch heads for use with the RS PRO modular metal push button series.
- Robust design with modern aesthetics delivered via metal bezel.
- Simple installation via clamp screws.
- Head Diameter 29mm
- Latching and Spring return head options
- Contact block mounting collar included
- Mechanical life more than 1 million uses

**IP65
RATED**



Stock No.	Colour	Lever	Positions	Spring Return	Actuation Diagram
205-2369	Black		2 Position	Return to Centre	
205-2370	Black	Long	2 Position	Return to Centre	
205-2376	Black		3 Position	Return to Centre	
205-2377	Black	Long	3 Position	Return to Centre	
205-2367	Black		2 Position	Stay Put	
205-2368	Black	Long	2 Position	Stay Put	
205-2374	Black		3 Position	Stay Put	
205-2375	Black	Long	3 Position	Stay Put	

Key Switch Heads

- 2 or 3 position key switch heads for use with the RS PRO modular metal push button series.
- Robust design with modern aesthetics delivered via metal bezel.
- Simple installation via clamp screws.
- Head Diameter 29mm
- Latching and Spring return head options
- Contact block mounting collar included
- All key switches from the RS PRO plastic modular series are supplied with alike keys



Stock No.	Positions	Cut Out Ø	Key Removal	Actuation Diagram	Spring Return
205-2372	2 Position	22.5mm	Left Only		Latching
205-2371	2 Position	22.5mm	Left & Right		Latching
205-2380	3 Position	22.5mm	Centre Only		Latching
205-2379	3 Position	22.5mm	Left, Right & Centre		Latching
205-2373	2 Position	22.5mm	Left Only		Return Right to Centre
205-2381	2 Position	22.5mm	Centre Only		Return to Centre

Contact Blocks

- Screw terminal connection
- Stackable design for contact blocks (max 6)
- Mechanical life more than 1 million uses
- 500V AC / 10A Switching Capacity
- Spring return actuation



Stock No.	Contacts	Terminal	Actuation	Switching Capacity	Mounting Type
205-2382	NO	Screw	Spring Return	500V AC / 10A	Screw
205-2383	NC	Screw	Spring Return	500V AC / 10A	Screw

Legend Plates

- Pack of 5
- 30mm x 40mm Size
- Compatible with Ø 22.5mm Control or Signalling Unit

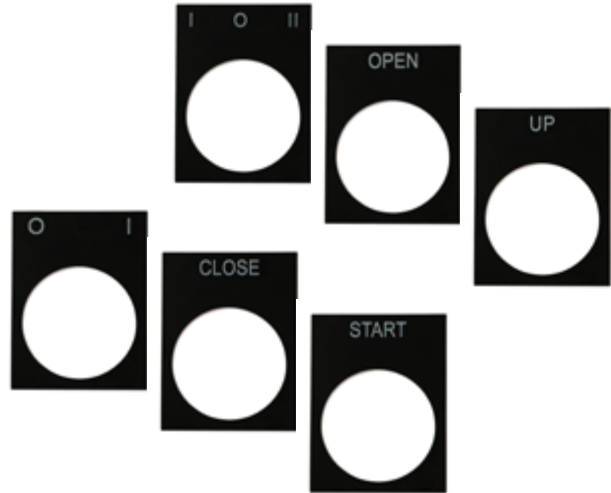

Stock No.	Print	Pack Size
175-3954	O-I	5
175-3955	CLOSE	5
175-3956	DOWN	5
175-3958	FORWARD	5
175-3959	I-O-II	5
175-3960	OFF, - ON	5
175-3961	OPEN	5
175-3962	RESET	5
175-3964	REVERSE	5
175-3965	START	5
175-3966	STOP	5
175-3967	UP	5

Push Button Enclosures - Plastic

- Made with durable ABS plastic
- IP66 protection
- 22.5 mm cutout diameter for push button
- Supplied with 4 plastic screws

**IP66
RATED**



- 182-8655 1 Hole, Grey
- 182-8656 2 Hole, Grey
- 182-8657 3 Hole, Grey
- 182-8658 4 Hole, Grey

Push Button Enclosure - Diecast Aluminum

- Single hole empty control station
- Die cast aluminium
- Yellow lid on dark grey base
- House 22.5 mm push buttons and selector switches
- Robust
- IP65 Rated

**IP65
RATED**



- 136-8582 1 Hole, Yellow
- 136-8581 1 Hole, Yellow, with Shroud

Emergency Stop Mushroom Head Push Button Complete Unit

- Palm and Foot E-Stop device
- Large and distinctive pushbutton of visibility (Red)
- Emergency stop pushbutton- Pull to release
- Two M20 cable entries

IP65 RATED



242-0840 1 NO + 1 NC

Signal Tower

- Pre-configured RS PRO LED beacon tower is a robust unit that is easy to install using 4 mounting screws and a 2-pole cable at the base and steady LED light output
- Made from durable Polycarbonate, the tower unit is self-extinguishing, offers superior protection against UV and is impact-resistant, ideal for harsh environments

IP65 RATED



199-9760 3 Lights, 24 V,

199-9758 2 Lights, 24 V, 36 mm (Diameter) x 165 mm (Height)

E-STOP Push Button

- Yellow & Grey enclosure for greater visibility
- Red mushroom head push button with clear marked direction visibility
- IP65 rating offers reliability in harsh environments
- Two M20 knockout holes
- Twist release
- Screw with captive cable clamp

IP65 RATED



242-0842 1NC Contacts

242-0843 1NC + 1NO Contacts

242-0845 2NC Contacts

LED Warning Light Modules

- Dual voltage LED warning light modules - 3 x LED light
- Compatible with both 12V and 24V power systems and combine low power consumption with 15 flash patterns.
- Multiple units can be linked for synchronised / alternate flash

IP67 RATED



907-5955 Amber

907-5959 Red

907-5968 Green

Internal Piezo Buzzer

- Designed to be versatile, these internal buzzers operate at a wide voltage range and deliver crisp sound from a compact package.



LED Beacons

- Screw mounted beacon, sealed for life against dust and moisture ingress
- 4 flash patterns
- 77mm dia x 95mm high



907-5961 Amber, Low Prof, 10-100Vdc

907-5977 Amber, Low Prof, 110-230Vac

907-5974 Green, Low Prof, 10-100Vdc

907-5965 Red, Low Prof, 10-100Vdc

907-5971 Red, Low Prof, 110-230Vac

907-5980 Amber, 10-100Vdc

907-5996 Amber, 110-230Vac

907-5983 Red, 10-100Vdc

907-5999 Red, 110-230Vac

Stock No.	Tone Type	Supply Voltage	Sound Level	Frequency	Pack Size
622-1562	Slow pulse	60 to 250Vac/dc	82dB	2.3 to 3.3KHz	1
535-8483	Continous	4 to 28Vdc	98dB	2.3 to 3.3KHz	1
457-043	Fast Pulse	60 to 220Vac/dc	91dB	2.3 to 3.3KHz	5
535-8360	Fast Pulse	6 to 28Vdc	80dB	2.3 to 3.3KHz	1
535-8499	Slow Pulse	6 to 28Vdc	80dB	2.3 to 3.3KHz	1
622-1483	Slow Pulse	6 to 28Vdc	85dB	2.3 to 3.3KHz	1

Sealed Miniature Toggle Switches

- These full sealed switches feature a double shell case for added mechanical strength and high electrical insulation
- The switches have a two 'O' ring frontal seals that maintain the seal during operation
- The rear of the switch is also fully sealed allowing full protection from flowing water
- The contacts are suitable for both low level switching (10 mA 50 mV - 10 µA, 5 V dc minimum) and power applications (3 A @ 250 V ac)



IP67 RATED

820-0504	12mm on-on
820-0508	12mm on-momentary
820-0517	12mm on-off-on
820-0510	12mm (on)-off-(on)
820-0514	12mm on-off-momentary
820-0523	12mm on-on-on
820-0526	12mm (off)-on-(off)
820-0542	12mm on-on
820-0539	12mm on-on
820-0551	12mm on-momentary
820-0532	12mm on-momentary
820-0554	12mm on-off-on
820-0558	12mm (on)-off-(on)

21x15mm Miniature Rocker Switches

- Miniature SPST rocker switches, available in a wide variety of markings and colour options
- Panel cut out 19.2 x 13 mm
- Fitted with 4.8 mm blade style terminals (except stock no. 419-726 which has solder tag terminals)
- Snap-in mounting, easy to install into panel
- Nylon Housing to UL 94V-2 with silver plated brass terminals



419-726	SPNO Black, on-off
419-732	SPST Black, on-off-on
419-744	SPNO Black, 0/I marking, on-off
419-748	SPNO Red, 0/I marking, on-off
419-750	SPST Red, 0/I marking, on-off
419-754	SPST Black, 0/I marking, on-off
419-798	SPNO White/black, 0/I marking, on-off
419-794	SPNO Red/black, 0/I marking, on-off
419-782	SPDT Red Illum.,220-250V neon, on-off-on
419-788	SPDT Green Illum.,220-250V neon, on-off-on

C/O Microswitch

- Pre-wired fully sealed single pole changeover switch
- Glass fibre reinforced nylon enclosure, fully sealed to IP67
- Pre-wired lead length: 0.5 m
- 5 A @ 250 V ac

IP67 RATED



797-2542	Plunger actuator
797-2549	Short roller actuator

Ultra Miniature Microswitch

- Actuator types supplied as a basic switch plus unfitted actuator kit with fixing hardware
- SPDT silver-plated contacts
- Contact Rating: 7 A (Resistive); 4 A (Inductive), 250 V ac; 28 V dc
- Operating temperature range: -54 to +121°C



333-316	Lever
333-300	Leaf
333-322	Roller leaf

Professional Grade Toggle Switches

- Slow make-and-break action switches ideal for low voltage or current applications, such as audio or video signals
- Chrome-plated lever
- Solder bucket terminals
- 0.4 VA max load
- Glass filled polyester case



316-995	4P on-on silver,6A
316-973	1P on-on silver,6A
317-572	1P on-on Au contact locklever switch
317-005	1P on-off-on slv6A
316-989	2P on-on silver,6A
317-588	2P on-on Au contact lever switch,6A
344-710	2P on-on-on silver
317-178	2P on-off-on,6A

Metal Housed Micro Switch

- Metal housed 15 A 250 V rated, snap action micro switches
- Single pole changeover contacts, NO/NC
- Insulated terminal cover plate
- Rated to 1,000,000 operations



797-2501	Plunger, IP54
797-2498	Lever roller, IP54
797-2494	Roller plunger, IP40
797-2508	Plunger Pre-wired, IP54

Series S Microswitch

- Heavy duty actuator spring with adjustable roller
- Synthetic rubber plunger, zinc alloy housing
- Insulated terminal cover plate
- Rated to 1,000,000 operations



804-6186	15 A @ 250 V ac
----------	-----------------

PROGRAMMABLE CONTROL DEVICES

Make your control panel smart and keep your production line well-connected with RS PRO. RS PRO's choice of HMI displays, featuring larger monitors, smoother touchscreens and high-powered processors.

Touch Screen HMI Displays

- High-performing HMI display used to monitor machines, perform tasks and visualise operational status



215-6604	7 in screen, USB interface
215-6605	7 in screen, USB, Ethernet interface
215-6606	10.2 in screen, USB, Ethernet interface

3 Digit, 3 Line Digital Multi-function Meters

- 3 Digit digital (96x96mm) panel meters offering measurement of key electrical parameters in 3 phase 4-wire, 3 phase three wire and single phase networks
- This single multi-function meter can replace multiple analogue panel meters
- Measurements include AC voltage, AC current, Frequency and more
- True RMS measurement
- Onsite programmable



136-5377	3Ph, V A F
136-5378	3Ph, V A F + Limit Relay

4 Digit, 3 Line Digital Multi-function Meters

- 4 digit, multi line, LED multi-function, 96x96mm, digital meters offering a choice of parameter measurement in a single unit
- Measurements include AC voltage, AC current, Frequency, energy and more
- Limit switch relay output option
- User selectable CT secondary 1A/5A and PT secondary from 100 VLL to 500 VLL
- User selectable 3 ph 3 wire/3 ph 3 wire/ single phase network
- Wide auxiliary power supply which can accept any input between 40 V-300 V ac/dc or 12 V-48 V dc
- Storage of MIN/MAX values
- Measurement and display of RPM, run hours, on hours and No. of interrupts



136-5380	3Ph, V A F
136-5379	3Ph, V A F + Limit Relay
136-5383	3Ph, V A F & Energy + RS485
136-5384	3Ph, V A F, Energy + Limit & RS485

Programmable Counter

- 6 Digit LED display
- 24V & 230V options available
- NEMA 4X Protection (IP65 frontal, IP20 rear)
- SPST relay output rated at 5A @ 250V (Resistive Load)
- Supports NPN/PNP operation
- Inputs for capacitive & proximity sensors and an encoder
- Manual & automatic reset options



808-6605	48x48, 230V
808-6614	48x48, 24V
808-6627	96x48, 230V
808-6636	96x48, 24V

Digital Time Switch

- Daily/weekly/pulse switching (depending on model)
- 3 lines text LCD display and DIN Rail mounting
- 25 On/Off programs
- LED indication of relay status
- 12/24 h display formats
- 6 years battery reserve
- Simple reset and manual override
- 110-240 V ac supply voltage
- Settable DST & keypad lock feature
- IP20 (terminals), IP40 (enclosure) protection



896-6876	110-240Vac 1 Channel (by sec)
896-6891	12Vdc 1 Channel
896-6885	10-240Vac 1 Channel (by min)

Multi-function Digital Timer

- 35x77mm panel mounting timer with Start/stop/reset control from front panel
- 9 timer modes, fully adjustable and easy to install
- Timing in seconds, minutes and hours on a bright LED display
- Two timed control outputs



124-1077	230V ac
124-1078	24V ac/dc

Logic Modules

- Compact, Low cost, logic modules from RS Pro - easy to program via USB with FREE software
- Basic logic controller is available with or without LCD display and offers 8 DI + 4 Relay Output
- Two of the inputs can be used as analogue (917-6370 & 917-6377)
- 250 lines of ladder programming - including timers, counters, Boolean, timeswitch functions and comparison functions
- RS Pro Logic Module software is available as a free download via the following link:
- http://download.designspark.info/RS_Logic_Module.zip



917-6361	Logic Module w. Display 8I/4O 110-240V
917-6370	Logic Module w. Display 8I/4O 12-24V
917-6373	Logic Module w/o Display 8I/4O 110-240V
917-6377	Logic Module w/o Display 8I/4O 12-24V
917-6386	Expansion Module 8I/4O 110-240Vac
917-6389	Expansion Module 8I/4O 12-24Vdc
917-6383	RS485 Comms module 110-240Vac
917-6392	RS485 Comms module 12-24Vdc
917-6395	USB Programming Cable
917-6399	Memory Module

Digital Hour Meter

- Digital hour meters come in a small variety of bezels and a wide range of supply voltage.
- 6-digit (5 mm) LCD display
- Panel mounting
- Wide range of supply voltage
- Remote reset
- Available in 3 different bezels (depending on model)
- Lower power consumption



896-6955	Round Face 12-48Vac/dc
896-6977	Rectangular Face 12-48Vac/dc
896-6986	Rectangular Face 24x48mm 10-80Vdc
896-6973	23mm x 36.5mm 85-265Vac
896-6967	23mm x 45.5mm 85-265Vac

DIN Rail Temperature Controller

- Text/Icon matrix display
- Quick setup menu with main configuration parameters
- 3 button operation along with 3 status LEDs



Stock No.	Supply Voltage	Number of Outputs	Communications
144-8680	110-240V ac	1 x C/O Relay, 1 x Relay	Not fitted
144-8681	110-240V ac	1 x C/O Relay, 1 x SSR, 1 x Relay	Not fitted
144-8682	110-240V ac	1 x C/O Relay, 1 x SSR, 1 x Relay	RS485 Comms
144-8677	24V ac/dc	1 x C/O Relay, 1 x Relay	Not fitted
144-8678	24V ac/dc	1 x C/O Relay, 1 x SSR, 1 x Relay	Not fitted
144-8679	24V ac/dc	1 x C/O Relay, 1 x SSR, 1 x Relay	RS485 Comms

PID Digital Thermostat

- 35x77mm size.
- Heating or cooling applications
- Thermocouple or PT100 inputs
- Two outputs for control and alarms
- ON/OFF or PID control
- On sensor failure, manual control can be selected.
- Sensor input offset setting
- Two setpoint - selectable from front panel.
- Selectable thermocouple types or PT100 input. (Specify at order).
- PID Autotune
- Soft-Start feature.
- Two outputs - Relay (control or alarm) and SSR (control)
- CE marked



Stock No.	Input Type	Number of Inputs	Supply Voltage	Number of Outputs	Dimensions
124-1058	PT100	1	230 V ac	1 x relay, 1 x SSR	35x77mm
124-1059	Thermocouple	1	230 V ac	1 x relay, 1 x SSR	35x77mm
124-1060	Thermocouple	1	24 V ac/dc	1 x relay, 1 x SSR	35x77mm

Digital Thermostat

- Ingress Protection (IP) ratings of IP20 and IP65
- Compact in size (35x77mm) making it easy to install
- Panel depth of 61 mm
- NTC (negative temperature coefficient) sensor, J Type Thermocouple & PT100 input options available



Stock No.	Input Type	Number of Inputs	Supply Voltage	Number of Outputs	Dimensions
124-1045	NTC	1	230 V ac	1	35x77mm
124-1046	NTC	1	24 V ac/dc	1	35x77mm
124-1047	NTC	1	230 V ac	2	35x77mm
124-1048	NTC	1	24 V ac/dc	2	35x77mm
124-1049	NTC	2	230 V ac	3	35x77mm
124-1050	NTC	2	24V ac/dc	3	35x77mm

ON/OFF Thermostat - J Thermocouple

- Ingress Protection (IP) ratings of IP20 and IP65
- Compact in size (35x77mm) making it easy to install
- Panel depth of 61 mm
- NTC (negative temperature coefficient) sensor, J Type Thermocouple & PT100 input options available



Stock No.	Input Type	Number of Inputs	Supply Voltage	Number of Outputs	Dimensions
124-1051	J Type Thermocouple	1	230 V ac	1	35x77mm
124-1052	J Type Thermocouple	1	24V ac/dc	1	35x77mm

Digital Thermostat

- High quality digital controller offers a single NTC probe input.
- Featuring built in On/Off or pulse output status, it can also be used as an alarm unit.
- This controller is Easy to configure and install, with a large clear display giving good visibility alongside a compact design.
- Ideal for use with NTC sensors.
- 35x77mm size



Stock No.	Input Type	Number of Inputs	Supply Voltage	Number of Outputs
124-1053	NTC	1	24 V ac/dc	1
124-1054	NTC	1	230 V ac	1
124-1055	NTC	1	24 V ac/dc	2
124-1056	NTC	1	230 V ac	2

DIN Rail Thermostat

- Designed for use with NTC sensors
- Easy to configure and use, along with a large clear display that gives greater visibility
- Compact design which makes it fast to install in various application fields



Stock No.	Input Type	Number of Inputs	Supply Voltage	Number of Outputs
124-1057	NTC	1	230 V ac	1

PID Temperature Controller

- Designed to provide temperature control in an easy to install, fast to program device
- The temperature is displayed on a large, highly improved LED display
- Front Fascia 1/16 DIN = 48 x 48mm
- 124-1083 Terminal cover fits onto 96 x 48 mm and 48 x 48 mm
- Depth 67mm



Stock No.	Front Fascia Size	Supply Voltage	Number of Outputs
124-1061	96 x 48mm	24V ac/dc	1 x SSR, 2 x Relay
124-1062	96 x 48mm	24V ac/dc	3 x Relay
124-1063	96 x 48mm	110-240V ac	1 x SSR 2 x Relay
124-1064	96 x 48mm	110-240V ac	3 x Relay
124-1065	48 x 48 mm	110-240V ac	2 x Relay
124-1066	48 x 48 mm	110-240V ac	1 x SSR, 1 x Relay
124-1070	48 x 48 mm	110-240V ac	2 x SSR 1 x Relay
124-1071	48 x 48 mm	110-240V ac	1 x SSR 2 x Relay
124-1072	48 x 48 mm	110-240V ac	3 x Relay
124-1067	48 x 48 mm	24V ac/dc	2 x SSR 1 x Relay
124-1068	48 x 48 mm	24V ac/dc	1 x SSR 2 x Relay
124-1069	48 x 48 mm	24V ac/dc	3 x Relay

PROCESS CONTROL & PROTECTION

From DIN Rail to Embedded Switch Mode Power Supplies, up to Power Monitors - RS PRO covers your every need.

DIN Rail Power Supplies

- Adjustable output voltage power supplies for DIN rail mounting.
- These DIN rail mount power supplies are available with a range of power ratings from 15 W to 240 W and accept single-phase AC input for conversion into a single DC output of either 12V, 15V, 24V or 48V DC.



Image for illustrative purposes only

Stock No. 	Input Electrical Phase	Input Voltage	Output Voltage	Output Voltage Adjustment Range	Output Current	Power Rating	Dimensions W x H x D
136-8301	Single Phase	230V	12V DC	11.6 - 12.3V	1.2A	15W	22.5 x 95 x 108mm
136-8302	Single Phase	230V	15V DC	13 - 16V	15V	15W	22.5 x 95 x 108mm
136-8303	Single Phase	230V	24V DC	23.5 - 24.5V	650mA	15W	22.5 x 95 x 108mm
136-8304	Single Phase	230V	5V DC	4.5 - 5.3V	5A	30W	36 x 95 x 108mm
136-8305	Single Phase	230V	12V DC	11.6 - 12.3V	2.5A	30W	36 x 95 x 108mm
136-8306	Single Phase	230V	15V DC	13 - 16V	2.0A	30W	36 x 95 x 108mm
136-8308	Single Phase	230V	24V DC	23.5 - 24.5V	1.3A	30W	36 x 95 x 108mm
136-8309	Single Phase	230V	12V DC	11.6 - 12.3V	4.2A	50W	30 x 130 x 125mm
136-8310	Single Phase	230V	24V DC	23.5 - 24.5V	2.2A	50W	30 x 130 x 125mm
136-8311	Single Phase	230V	48V DC	47.5 - 48.3V	1.1A	50W	30 x 130 x 125mm
136-8312	Single Phase	230V	12V DC	11 - 14V	5A	70W	33 x 130 x 125mm
136-8315	Single Phase	230V	24V DC	23 - 28V	3A	70W	33 x 130 x 125mm
136-8316	Single Phase	230V	48V DC	47 - 55V	1.5A	70W	33 x 130 x 125mm
136-8317	Single Phase	230V	12V DC	11 - 14V	8A	120W	40 x 130 x 125mm
136-8319	Single Phase	230V	24V DC	23 - 28V	5A	120W	40 x 130 x 125mm
136-8320	Single Phase	230V	48V DC	47 - 55V	2.5A	120W	40 x 130 x 125mm
136-8321	Single Phase	230V	24V DC	22 - 28V	10A	240W	60 x 130 x 125mm
136-8322	Single Phase	230V	48V DC	45 - 55V	5A	240W	60 x 130 x 125mm

Power Line Filter

- Significantly reduces the amount of conducted frequencies between your equipment and the connecting power line.
- Rated currents up to 10A



Stock No. 	Maximum Voltage Rating	Maximum Current Rating	Number of Phases	Mounting Type
237-8738	300/520 V ac	8A	3	Chassis Mount
237-8739	520 V ac	8A	3	Chassis Mount
237-8741	520 V ac	20A	3	Chassis Mount
237-8742	300/520 V ac	25A	3	Chassis Mount
237-8744	520 V ac	25A	3	Chassis Mount
237-8745	300/520 V ac	30A	3	Chassis Mount
237-8746	520 V ac	30A	3	Chassis Mount
237-8748	520 V ac	150A	3	Chassis Mount

RS510 Single Phase Inverters with Integral Filter

- These single phase inverter drives are suitable for a wide range of drive applications and come with a filter built-in
- Cost effective drive solution with wide range of programming capabilities and offering both V/F mode or Sensorless Vector operation
- Integral 5 digit operator panel and speed control potentiometer
- PID Process Control Loop
- 0-10VDC or 4-20mA Feedback & Control
- Built-in Modbus (RJ45 Interface)
- Digital Inputs



122-3410	0.4KW, 0.50HP
122-3411	0.75KW, 1HP
122-3413	1.5KW, 2HP
122-3414	2.2KW, 3HP

Time Delay Relay - 17.5mm

- DIN Rail mounting
- Off delay timing function
- Integrated dual voltage
- LED indications for power and relay status
- Wide supply voltage range
- IP20 (terminals), IP40 (enclosure) protection



896-6816	On Delay, 110Vac & 24Vac/dc
896-6810	On Delay, 240Vac & 24Vac/dc
896-6829	Off Delay, 110Vac & 24Vac/dc
896-6822	Off Delay, 240Vac & 24Vac/dc

10A Industrial Relay

- Protected by a clear polycarbonate cover
- DIN Rail or Surface Mounting
- Contact Material: Ag + Au Flashed
- Contact Rating is 10A
- Maximum temperature at rated coil voltage 65°C
- Dimensions: H 53mm, W 36mm, D 36mm



Stock No.	Coil Voltage	Configuration	Coil Power	Terminal Type
348-829	24Vdc	3PDT	1.2W	Plug In
349-282	115Vac	3PDT	2.75W	Through Hole
348-813	230Vac	3PDT	2.75W	Plug In
348-756	12Vdc	DPDT	1.2W	Plug In
348-784	24Vdc	DPDT	1.2W	Plug In
349-327	24Vac	DPDT	2W	Plug In
348-778	115Vac	DPDT	2W	Plug In
348-762	230Vac	DPDT	2W	Through Hole

LX Series Three Phase Monitoring Relays

- Adjustable under or under/over voltage monitoring relays with true RMS measurement
- Measures phase to phase voltages and detects incorrect phase sequence and phase loss
- Adjustment for voltage trip level & time delay
- 1 x SPDT relay output 8A & LED indication



102-6136	Under voltage
102-6137	Under and over voltage

Multi-function Time Delay Relay - 22.5mm

- Two multi-function timer relays offering a choice of common timing functions - including external trigger inputs
- 0.1s to 10/100h timing ranges
- Configured & set via flush knobs on front
- LED indication for runtime and relay status
- Full details of timer functions available online



896-6850	5 Function timer, SPCO, 24-240Vac/dc
896-6813	10 Function timer, SPCO, 12-240Vac/dc

L Series Battery Voltage Alarm

- Adjustable battery under-voltage alarm monitoring relay for 9-28Vdc - ideal for 12v or 24v battery systems
- Adjustment for Time delay (from an Under voltage condition)



102-6130	1 x SPDT relay output 8A with LED indication
-----------------	--

LEDO - Single Function Timers

- Choice of On-delay or Off-delay timers with either a single or double pole output
- 7 selectable time ranges and fine adjustment of timing period
- Multi-voltage supply input (12-230Vac/dc)
- LED indication of supply & relay status



102-6124	Delay on timer 1 x SPDT
102-6128	Delay off timer switch initiated
102-6125	Delay on timer 1 x DPDT

LMMT - Multifunction Timers

- Multifunction timer LMMT in a 17.5mm DIN rail housing with 7 selectable functions and 7 time ranges
- Fine adjustment of selected time range
- LED indication of supply and relay status
- Multi-voltage supply input (12 - 230Vac/dc)



102-6122	SPDT
102-6123	DPDT

L Series AC Under/Over Voltage Relay

- True R.M.S. monitoring of own supply and detects if the single phase supply exceeds the set Under or Over voltage trip levels
- Adjustment for Under voltage and Over voltage trip level
- Adjustment for Time delay (from an Under or Over voltage condition)
- 1 x SPDT relay output 8A with LED indication for supply status



102-6131	1 Ph Under & Over Volt + Time Del Relay
-----------------	---

RKL Miniature Power Relays

- 10A Industrial Plug-in Relay
- Gold plated contact
- Double side LED integrated in relay
- Lockable test button and inspection window
- Identification of coils through test button colour (AC red / DC blue)
- Conformity with RoHs directive



Stock No.	Nominal Voltage	Poles	Switching Current	Options
121-7804	12Vdc	SPCO	16A	LED + Test Button + Diode
121-7807	24Vdc	SPCO	16A	LED + Test Button
121-7806	24Vac	SPCO	16A	LED + Test Button + Diode
121-7808	110Vac	SPCO	16A	LED + Test Button
121-7809	240Vac	SPCO	16A	LED + Test Button
121-7810	12Vdc	DPCO	10A	LED + Test Button + Diode
121-7811	24Vdc	DPCO	10A	LED + Test Button + Diode
121-7812	24Vac	DPCO	10A	LED + Test Button
121-7813	110Vac	DPCO	10A	LED + Test Button
121-7814	230Vac	DPCO	10A	LED + Test Button
121-7815	12Vdc	3PCO	10A	LED + Test Button + Diode
121-7816	24Vdc	3PCO	10A	LED + Test Button + Diode
121-7817	24Vac	3PCO	10A	LED + Test Button
121-7818	110Vac	3PCO	10A	LED + Test Button
121-7820	12Vdc	4PCO	10A	LED + Test Button + Diode
121-7821	24Vdc	4PCO	10A	LED + Test Button + Diode
121-7822	24Vac	4PCO	10A	LED + Test Button
121-7824	230Vac	4PCO	10A	LED + Test Button

RKL Relay Sockets

- DIN Rail mount relay sockets
- Screw connection
- Supplied with metal retaining clip



121-7825	DPCO
121-7826	3PCO
121-7827	4PCO

RKE/RKF Relay Sockets

- DIN Rail mount relay sockets
- Screw connection
- Supplied with metal retaining clip



121-7803	Cage screw
121-7802	Rising screw

RUB General Purpose Octal Relay

- 2 or 3 Pole 10A General Purpose Octal Relay
- Gold plated contact
- Double side LED integrated in relay
- Lockable test button and inspection window
- Identification of coils through test button colour (AC red / DC blue)
- Conformity with RoHs directive



Stock No.	Nominal Voltage	Poles	Switching Current	Options
121-7828	12Vdc	DPCO	10A	LED + Test Button + Diode
121-7829	24Vdc	DPCO	10A	LED + Test Button + Diode
121-7830	24Vac	DPCO	10A	LED + Test Button
121-7831	110Vac	DPCO	10A	LED + Test Button
121-7832	240Vac	DPCO	10A	LED + Test Button
121-7837	110Vac	3P	10A	LED + Test Button
121-7834	12Vdc	3P	10A	LED + Test Button + Diode
121-7835	24Vdc	3P	10A	LED + Test Button + Diode
121-7836	24Vac	3P	10A	LED + Test Button
121-7838	240Vac	3P	10A	LED + Test Button

RKF 4PCO Miniature Power Relay

- 4 Pole 6A Industrial Plug-in Relay
- Gold plated contact
- Double side LED integrated in relay
- Lockable test button and inspection window
- Identification of coils through test button colour (AC red / DC blue)
- Conformity with RoHs directive



Stock No.	Nominal Voltage	Poles	Switching Current	Options
121-7797	12Vdc	4PDT	6A	LED + Test Button + Diode
121-7798	24Vdc	4P	6A	LED + Test Button + Diode
121-7799	24Vac	4P	6A	LED + Test Button
121-7800	115Vac	4P	6A	LED + Test Button
121-7801	240Vac	4P	6A	LED + Test Button

RUB Relay Sockets

- DIN Rail mount relay sockets
- Screw connection
- Supplied with metal retaining clip



121-7839	8 pin 12A
121-7841	8 pin 15A
121-7840	11 pin 12A
121-7842	11 pin 15A

Motor Protection Switches

- Professional range of motor protection switches suitable for 3 phase motors up to 32A
- The switches incorporate an automatic switch-off at current and thermal and magnetic releases
- 35 mm DIN Rail, can be mounted in either vertical or horizontal
- MS32 Series



121-6858	25-32A
121-6857	20-27A
121-6856	17-23A
121-6855	13-18A
121-6854	9-14A
121-6853	6.3-10A
121-6852	4-6.3A
121-6851	2.5-4A
121-6850	1.6-2.5A
121-6849	1-1.6A
121-6848	0.63-1A
121-6847	0.4-0.63A
121-6846	0.25-0.4A
121-6845	0.16-0.25A

Shunt & Under-Voltage Release

- Shunt release to allow remove disconnect of starter from switch or PLC control
- Under-voltage release senses low motor supply voltage and disconnects starter
- MS32 Series



121-6871	AR240 - Shunt release
121-6869	UR240 - Under voltage release

Auxiliary Switches

- Auxiliary switches available with either 1 or 2 make/break contacts
- MS32 Series



121-6864 HS 20 - 2 NO Contacts

Enclosure

- IP41 and 55 rated enclosures for use with MS32 & MSB32 Motor Protection Circuit Breakers



**IP
RATED**

121-6860 HO-55 IP55
121-6859 HO-41 IP41

Auxiliary Contact Blocks

- Professional range of MS32 series auxiliary contact blocks
- The auxiliary contact blocks are available with either make or break contacts
- Available in horizontal or vertical fitment
- MS32 Series



121-6867	HRS10 - Trip indicating - NO
121-6868	HRS01 - Trip indicating - NC
121-6866	HSV01 - Auxiliary - NC
121-6865	HSV10 - Auxiliary - NO

Enclosed Direct-on-line Motor Starters

- A range of enclosed Direct-On-Line motor starters which combine high performance and low cost
- Options with and without isolator and support for motors from 5.5 kW to 11 kW.
- Moulded plastic case providing IP65 ingress protection
- Compliant with standards IEC/EN 60947-1 and IEC/EN60947-4-1
- RF38 Overloads must be ordered separately to match motor current - See RS 685-1328



725-5503	5.5kW 230VAC Coil
725-5516	7.5kW 230VAC Coil
725-5507	5.5kW 400VAC Coil
725-5525	5.5kW 230VAC Coil + Isolator
725-5529	5.5kW 400VAC Coil + Isolator

Soft Starter

- This RS PRO soft starter is used to protect your motor when it starts and stops. It's designed to reduce torque, load and electrical surges when a motor kick-starts, improving the motor's lifespan.
- Made for use on single-phase motor types, this soft starter is well-suited to industrial automation processes to improve motor performance and efficiency.
- It has a DIN rail mount type.



209-6340 2.2 kW, 230 V ac, 1 Phase

Contactors

- Contactor Range for a variety of applications
- Three Coil actuation voltages to choose from
- Compact Design
- Contactors for switching AC-3 and AC-4 loads like asynchronous squirrel cage motors
- Different Coil voltages available
- Variety of auxiliaries including aux. Contact blocks; Surge suppressors, mechanical interlocks



Stock No.	Nominal Current	Coil Voltage	Poles	Power Rating	Configuration
250-8810	15A	24VDC	3	7.5 kw	1NC
250-8802	15A	24V 50/60Hz	3	7.5 kw	1NC
250-8803	15A	110V 50/60Hz	3	7.5 kw	1NC
250-8804	15A	230V 50/60Hz	3	7.5 kw	1NC
250-8808	15A	400V 50/60Hz	3	7.5 kw	1NC

Thermal Overload Relay

- Overload Relays for protection of asynchronous squirrel cage motors
- Phase failure sensitivity and temperature compensation
- Reset pushbutton manual/auto
- Test/off pushbutton
- Integrated Aux. Contact
- Direct mount on Contactor



Stock No.	Nominal Current Range	Aux Contacts
250-8879	0.4- 0.6	1 N/O 1N/C
250-8880	0.6- 1	1 N/O 1N/C
250-8881	1- 1.6	1 N/O 1N/C
250-8882	1.6- 2.4	1 N/O 1N/C
250-8883	2.4- 4	1 N/O 1N/C
250-8884	4- 6	1 N/O 1N/C
250-8885	6- 10	1 N/O 1N/C
250-8886	9- 12	1 N/O 1N/C
250-8888	12- 16	1 N/O 1N/C

CONTROL CABINET WIRING

















Here are the most popular RS PRO parts for professional wiring of a control cabinet. Starting from bootlace ferrules to the right stripping and crimping tools, to cable markers, ties, heatshrinks and insulation tapes.

Tri-Rated Cable

- A tinned copper stranded conductor covered with a PVC sheath
- Suitable for internal connectors in equipment, motor starters and controllers as well as in switch control, relay and instrumentation panels for power and switchgear
- Operating Temperature up to 90°C for continuous use
- Voltage up to 600V AC
- The triple rating of BS6231 (UK), CSA TEW (Canada) and UL style 1015, 1028 or 1283 (America) makes it acceptable across many markets, for applications including high voltage wiring within electrical cabinets, switchgear wiring, rectifier equipment and motor starter circuitry.



Stock No. 	Area	Colour	Reel length
180-5940	1.0 mm ²	 Orange	100m
180-5938	1.0 mm ²	 Red	100m
180-5943	1.0 mm ²	 Violet	100m
180-5936	1.0 mm ²	 Black	100m
180-5941	1.0 mm ²	 Blue	100m
180-5933	1.0 mm ²	 Brown	100m
180-5934	1.0 mm ²	 Green	100m
180-5939	1.0 mm ²	 Yellow	100m
180-5942	1.0 mm ²	 Grey	100m
811-1451	4.0 mm ²	 Brown	100m
811-1442	4.0 mm ²	 Black	100m
811-1436	4.0 mm ²	 Blue	100m
811-1448	4.0 mm ²	 Red	100m
811-1445	4.0 mm ²	 Green/yellow	100m
906-2713	4.0 mm ²	 Dark blue	100m
815-8627	4.0 mm ²	 Green	100m
811-1458	4.0 mm ²	 Grey	100m
815-8609	4.0 mm ²	 Light Blue	100m

Stock No. 	Area	Colour	Reel length
815-8618	4.0 mm ²	 Orange	100m
815-8615	4.0 mm ²	 Violet	100m
815-8624	4.0 mm ²	White	100m
811-1454	4.0 mm ²	 Yellow	100m
811-1470	6.0mm ²	 Black	100m
811-1476	6.0mm ²	 Blue	100m
811-1489	6.0mm ²	 Brown	100m
906-2717	6.0mm ²	 Dark blue	100m
811-1473	6.0mm ²	 Green/yellow	100m
811-1464	6.0mm ²	 Grey	100m
815-8621	6.0mm ²	 Light blue	100m
815-8630	6.0mm ²	Orange	100m
811-1467	6.0mm ²	 Red	100m
815-8646	6.0mm ²	White	100m
811-1460	6.0mm ²	 Yellow	100m
628-5320	10.0mm ²	 Black	100m
628-5342	16.0mm ²	 Black	100m
815-8687	25.0mm ²	 Black	100m

Wire Cutters

- General purpose light duty wire cutters
- Ideal for educational environments
- Stainless steel version is fitted with moulded plastic grips and lightweight return springs
- Tool steel tools have PVC handle grips fitted with quick return coil springs



- 536-420** Semi-flush
- 536-379** Side
- 536-329** Side flush, Stainless Steel

Insulated wire strippers

- Ideal for working up to 1000Vac or 1500Vdc
- Suitable for single and multi-strand conductors
- DuoTech softgrip handles and chrome finish
- VDE Approved
- Overall length: 160mm



- 125-3075** 0.01 - 10 mm² Stripping Range

2 Piece Crimper & Stripper Tool Module

- Automatic wire and cable stripper with soft grip ergonomic handles and a self-adjustment mechanism for easy operation
- Also capable of crimping terminals
- Supplied with an automatic crimping pliers for use on insulated terminals
- Bright red foam helps identify missing parts quickly
- Foam tool modules are designed for regular easy removal from drawers



- 833-5966** 205mm Automatic Cable Stripper + 220mm Automatic Crimping Pliers

Self-adjusting wire strippers

- For use with round, oval and fat wire and cables
- Increased control and a smooth stripping action
- Adjustable sliding wire stop to preset exact stripping lengths
- Precision carbon steel laminated stripping blades



- 243-257** 0.2 - 6 mm² Stripping Range
- 382-2847** 0.08 - 2.5 mm² Stripping Range
- 243-263** 0.2 - 6 mm² Replacement Jaw
- 382-2853** 0.08 - 2.5 mm² Replacement Jaw

Mains Sheath Cable Stripper

- Perfect for 2-core and 3-core mains cables and leads
- Produces safe ring-of-cut for outer and inner insulation on all types of flexible cable
- Compact pocket-sized design with built-in cutter



- 663-437** 0.1 - 9mm Stripping Range

Automatic Wire Stripper

- Zinc alloy body and handle
- High carbon steel for the cutting and stripper knife blades.
- Spring steel for auto return tension spring.
- Suitable for use with PVC, silicone rubber and others
- Overall length: 165mm



- 663-617** 22 - 8AWG Stripping Range

Triple Action Cable Stripper

- Unique spiral-strip selector for hard-to-strip insulations
- Cuts through insulation up to 3mm thick
- Rotary, linear or spiral cut



- 262-0151** 4.5 - 29mm Stripping Range
- 262-0167** Replacement blades

Self Adhesive Wire Markers

- Stick to wires for permanent identification
- Suitable for different cable diameters
- Can be applied before or after the terminal has been connected



Cable Marking Kits - Slide-on

- 4500 high-quality slide on PVC cable markers
- Includes letters, numbers and symbols
- Supplied in a useful compartment box for easy transportation
- Special profile to fit a range of cable diameters
- Ideal for marking electrical wires and cables



812-1528	0 - 9, book
812-1537	0 - 15, A - Z, +-
812-1530	1 - 45, book
812-1534	46 - 90, book

914-0602	0.75 - 3.5mm ²
914-0605	3.5 - 8mm ²
914-0592	2 - 8mm ²

Cable Markers

- Material: UL approved Nylon 66, 94V-2



Stock No.	Legend	For length	Colour	Pack
812-1231	Numbers 0-9	0.5mm ²	Black, Brown, Green, Grey, Orange, Red, Violet, White and Yellow	250
812-1203	Numbers 0-9	0.5 to 1.5mm ²	Black, Brown, Green, Grey, Orange, Red, Violet, White and Yellow	150
812-1219	Numbers 0-9	1.5 to 2.5mm ²	Black, Brown, Green, Grey, Orange, Red, Violet, White and Yellow	150
812-1225	Numbers 0-9	4 to 6mm ²	Black, Brown, Green, Grey, Orange, Red, Violet, White and Yellow	100
812-1240	Letters A-M	0.5mm ²	Yellow	325
812-1243	Letters N-Z	0.5mm ²	Yellow	325
812-1212	Letters A-M	0.5 to 1.5mm ²	Yellow	195
812-1215	Letters N-Z	0.5 to 1.5mm ²	Yellow	195
812-1221	Letters A-M	1.5 to 2.5mm ²	Yellow	195
812-1228	Letters N-Z	1.5 to 2.5mm ²	Yellow	195
812-1234	Letters A-M	4 to 6mm ²	Yellow	130
812-1237	Letters N-Z	4 to 6mm ²	Yellow	130

Heat Shrink Tubing Kits

- Mixed with different types of heat shrink tubing including harmonised colours.
- Contains 2:1 and 3:1 variants
- Sizes from 2.4 to 12.7mm
- Supplied in either a useful compartmented storage box or a slide out tray box that can be stacked or wall mounted
- Refill packs available on RS Online



- 397-679** 170 mixed piece kit, compartmented storage box
- 487-3852** 300 mixed piece kit, slide out tray box

Heatshrink Termination Kit

- Supplied with high quality Mil spec heatshrink sleeves in a range of colours to protect and insulate newly terminated cables.
- Contains heatshrink crimp splices, which after mechanical crimping, the use of a heat gun will shrink the adhesive outer to form a fully insulated and moisture proof seal.
- Black, Blue, Green/Yellow, Red, White Colours
- Sleeve diameters 3.2 mm, 4.8 mm, 6.4 mm, 9.5mm



- 562-646** 110mm sleeve length

PVC insulating tapes

- UV resistant
- Water resistant
- Flame retardant
- Self-extinguishing
- Easy to tear by hand
- Breakdown Voltage 8000V
- Compliant to EN 60454-3-1 Type 2



Stock No.	Colour	Thickness	Length
134-7321	Black	12 mm	20 m
134-7329	Black	38 mm	20 m
134-7319	Black	19 mm	33 m
134-7330	Blue	12 mm	20 m
134-7324	Blue	19 mm	33 m
134-7334	Green	12 mm	20 m
134-7331	Green	19 mm	33 m
134-7325	Green	12 mm	20 m
134-7328	Green	19 mm	33 m
134-7327	Red	12 mm	20 m
134-7323	Red	19 mm	33 m
134-7333	White	12 mm	20 m
134-7335	White	38 mm	20 m
134-7320	White	19 mm	33 m
134-7332	Yellow	12 mm	20 m
134-7326	Yellow	19 mm	33 m

Polyolefin Heatshrink Tubing 2:1

- High mechanical and electrical strength
- Corrosion and solvent resistant
- Bore sizes quoted are pre-shrink sizes (minimum) as supplied
- Supplied in lengths of 1.2 m



- 398-228** Black, 1.6mm
- 398-212** Black, 2.4mm
- 398-206** Black, 3.2mm
- 398-199** Black, 4.8mm
- 398-183** Black, 6.4mm
- 398-177** Black, 9.5mm
- 398-161** Black, 12.7mm
- 398-155** Black, 19.0mm
- 398-149** Black, 25.4mm
- 398-133** Black, 38.0mm
- 398-127** Black, 50.8mm
- 399-906** Clear, 2.4mm
- 399-928** Clear, 4.8mm
- 399-962** Clear, 19.0mm
- 399-978** Clear, 25.4mm
- 399-984** Clear, 38.0mm
- 399-990** Clear, 50.8mm
- 398-054** Yellow/green, 12.7mm
- 398-082** Yellow/green, 4.8mm

Heavy Duty Tubular Ring Terminals

- Made from copper with a tin plating
- Ideal for use on multistranded cables
- Available with a flared or a chamfered entry for ease of wire insertion



531-015	M5, 10mm ²
531-021	M6, 10mm ²
531-043	M6, 16mm ²
531-065	M6, 25mm ²
531-037	M8, 10mm ²
531-059	M8, 16mm ²
531-071	M8, 25mm ²
241-4631	M8, 35mm ²
531-885	M10, 35mm ²
531-891	M10, 50mm ²
531-914	M10, 70mm ²
241-4647	M10, 95mm ²
531-920	M12, 70mm ²
241-4669	M12, 95mm ²

800 Piece Insulated Crimp Terminal Kit with Hand Crimp Tool

- Contains 800 widely used terminal types and sizes
- Colour coded insulation for easy terminal size identification
- Plastic sleeve on terminals provides insulation and wire support
- Tin plating for good corrosion protection.
- Excellent electrical connection
- Sturdy plastic carrying case with compartments for ease of selection
- Integrated handles for easy portability
- Crimp tool for crimping wire size ranges from 0.25 to 6 mm²



613-9952 800 Piece Insulated Terminal + 1 Crimp tool

Tubular Ring Terminals

- Made from copper with a tin plating
- Ideal for use on multi-stranded cables
- Available with a flared or a chamfered entry for ease of wire insertion



841-7601	M5, 10mm ²
841-7598	M6, 6mm ²
841-7605	M6, 10mm ²
841-7617	M6, 16mm ²
841-7620	M6, 25mm ²
841-7608	M8, 8mm ²
841-7614	M8, 10mm ²
841-7611	M8, 16mm ²
841-7623	M8, 25mm ²
841-7636	M8, 35mm ²
841-7627	M10, 25mm ²
841-7639	M10, 35mm ²
841-7633	M10, 50mm ²
841-7645	M10, 70mm ²
841-7658	M10, 95mm ²
841-7655	M10, 120mm ²
841-7667	M10, 150mm ²
841-7642	M12, 50mm ²
841-7649	M12, 70mm ²
841-7651	M12, 95mm ²
841-7664	M12, 120mm ²
841-7661	M12, 150mm ²

Insulated Spade Connectors

- Made from copper with a tin plating
- Vinyl or nylon insulation with a flared design for easy wire insertion
- Colour coded to correspond with the wire size they are used with
- Various metric sizes available



534-632	Blue M3.5, 1.5 - 2.5mm ²
534-626	Blue M4, 1.5 - 2.5mm ²
613-9435	Blue M4, 6.4mm, 1.5 - 2.5mm ²
613-9514	Blue M5, 1.5 - 2.5mm ²
534-604	Blue M6, 1.5 - 2.5mm ²
239-4177	Mini-Yellow M3, 0.2 - 0.5mm ²
208-2515	Red M3, 0.5 - 1.5mm ²
613-9384	Red M3, 5.7mm, 0.5 - 1.5mm ²
534-272	Red M3.5, 0.5 - 1.5mm ²
613-9441	Red M3.5, 5.7mm, 0.5 - 1.5mm ²
125-1957	Red M3.5, 22-16 AWG
534-266	Red M4, 0.5 - 1.5mm ²
613-9479	Red M4, 6.4mm, 0.5 - 1.5mm ²
125-1958	Red M4, 22-16 AWG
613-9491	Red M5, 8.1mm, 0.5 - 1.5mm ²
534-244	Red M6, 0.5 - 1.5mm ²
534-496	Yellow M4, 2.5 - 6.5mm ²
613-9564	Yellow M4, 7.2mm, 4 - 6mm ²
534-480	Yellow M5, 2.5 - 6.5mm ²
613-9586	Yellow M5, 9mm, 4 - 6mm ²
534-474	Yellow M6, 2.5 - 6.5mm ²

Insulated Double Crimp Spade Terminals

- Made from brass with a copper sleeved barrel
- Vinyl or nylon insulation with a flared design for easy wire insertion
- Colour coded to correspond with the wire size they are used with



267-3852	Blue M3.5, 1 - 2.6mm ²
267-3846	Blue M4, 1 - 2.6mm ²
267-3717	Red M3, 0.5 - 1.5mm ²
267-3701	Red M3.5, 0.5 - 1.5mm ²
267-3694	Red M4, 0.5 - 1.5mm ²

750 Piece Insulated Crimp Terminal Kit

- 750 widely used terminal types and sizes
- Colour coded terminal sleeves for insulation and wire size identification
- Sturdy plastic carrying case with compartments and integral carrying handle



613-9974 750 Piece Kit

French Colour Coded Bootlace Ferrule Crimp Terminal Kit

- Portable, compact and uncluttered storage in minimum space
- Both kits contain 8 Ferrule compartments
- Plastic see-through cover
- Marked compartments, sorted by size and ease of selection

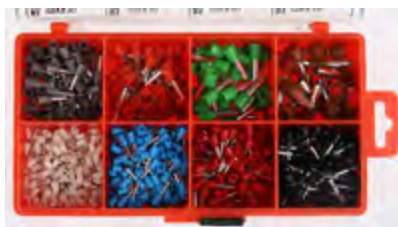

228-0321 0.5-10mm², 1000 pcs

Bootlace Ferrule Kit

- Colour coded insulation for easy ferrule size identification
- Excellent electrical connection
- Crimped terminal can be repeatedly inserted and removed from connection without degrading end of the wire
- Transparent plastic circular box for portable, compact and uncluttered storage
- 5 marked compartments sorted by size for ease of selection



513-2540 400 Piece kit, 0.5 - 2.5mm²

Crimping Pliers

- A full range of professional crimping pliers to ensure a high quality connection - both electrically and mechanically - between the ferrule and the wire.



683-1605 Crimp Tool, End Splice, 0.5 - 6mm², Square Crimping Profile

683-1614 Crimp Tool, End Splice, 10 - 25mm², Square Crimping Profile

Ratchet Crimping Tools

- Insulated AMP-type flag tool has 2 crimping cavities
- Heatshrink & Insulated terminal tool has 3 crimping cavities; 1.25mm² (22-16 AWG), 2mm² (16-14 AWG) and 5.5mm² (12-10 AWG)



125-1966 AMP flag terminals

125-1965 Heatshrink terminals

125-1964 Insulated terminals

Crimping Pliers

- A full range of professional crimping pliers to ensure a high quality connection - both electrically and mechanically - between the ferrule and the wire.



122-1791 0.14-10.00mm², Hexagon Profile

122-1790 0.14-10.00 mm², Square Profile

Ratchet Crimping Tool

- Durable and easy to use
- Made from high-quality hardened alloy steel
- Ratchet mechanism ensures that full crimp cycle is achieved
- Ratchet release mechanism
- Adjustable crimping force
- Ergonomically designed, non-slip handles for comfortable use



399-2031 0.5 - 16 mm², Square profile

Plier Action Bootlace Ferrule Hand Crimp Tool

- Plier action hand crimp tool for crimping bootlace ferrules



464-482 0.5 - 16 mm², Square profile

Sub-miniature Cable Ties

- For reduced diameter retention applications
- Available in either black or white
- Flammability rating UL94V-2



Stock No.	Width	Length	Colour	Pack Size
664-2887	1.6 mm	71mm	Black	100
664-2883	1.6 mm	71mm	White	100

Coloured Nylon Cable Ties

- Enable colour coding of cables or other components
- Temp rating: -50°C to +85°C
- Flammability rating UL94V-2



Stock No.	Width	Length	Colour	Pack Size
233-275	2.5mm	160mm	Green	100
404-550	3.6mm	203mm	Orange	100
233-297	2.5mm	200mm	Red	100

Double Locking Cable Ties

- Features a non-releasable double locking head
- Double locking design results in a more rounded shape around the cables
- Manufactured from UL listed Nylon 66
- Available in black or natural, in a range of sizes



Stock No.	Width	Length	Colour	Pack Size
865-9625	6mm	132mm	Black	100
865-9629	6mm	180mm	Black	100
865-9631	9mm	201mm	Black	100
865-9635	9mm	265mm	Black	100
865-9647	9mm	360mm	Black	100
865-9641	9mm	382mm	Black	100
865-9650	9mm	510mm	Black	100
865-9653	9mm	610mm	Black	100

UV Resistant Cable Ties

- Weather resistant cable ties with excellent UV resistance
- Easy and fast to install
- Ideal for use outdoors
- Available in a range of sizes



Stock No.	Width	Length	Colour	Pack Size
811-1482	2.5mm	100mm	Black	100
811-1486	3.2 mm	140 mm	Black	100
811-1495	4.8 mm	190 mm	Black	100
811-1498	4.6 mm	200 mm	Black	100
811-1518	7.6 mm	240 mm	Black	100
811-1511	7.6 mm	300 mm	Black	100
811-1492	4.8 mm	380 mm	Black	100
811-1502	4.8 mm	450 mm	Black	100
811-1515	8 mm	450 mm	Black	100
811-1524	9 mm	610 mm	Black	100
811-1527	7.5 mm	750 mm	Black	100

Flame Retardant Nylon Cable Ties

- Ideal for use where fire resistance is critical
- Flame Retardant to UL 94V-0 standard
- Available in either black or natural colour in a range of sizes
- Sold in pack of 100



Stock No.	Width	Length	Colour	Pack Size
811-1773	2.5mm	100mm	Black	100
811-1776	3.6mm	150mm	Black	100
811-1779	4.8mm	203mm	Black	100
811-1739	17.8mm	254mm	Black	50
811-1748	12.7mm	280mm	Black	50
811-1751	12.7mm	280mm	Natural	50
811-1741	12.7mm	380mm	Black	50
811-1760	12.7mm	380mm	Natural	50
811-1782	7.6mm	380mm	Black	100
811-1745	12.7mm	480mm	Black	50
811-1754	12.7mm	550mm	Black	50
811-1767	12.7mm	550mm	Natural	50

Standard Nylon Cable Ties

- Ideal for bundling and organising cables and wires
- Suitable for a multitude of uses
- Black and natural colours available in a range of sizes
- Self-extinguishing to rating UL94V-2



Stock No. 	Width	Length	Colour	Pack Size
233-455	2.5mm	100mm	Black	100
233-499	2.5mm	100mm	Black	1000
178-462	2.5mm	100mm	White	100
492-0447	2.5mm	100mm	White	1000
811-1694	2.5mm	203mm	Natural	100
233-465	3.6mm	150mm	Black	100
178-478	3.6mm	150mm	White	100
233-500	3.6mm	150mm	Black	1000
233-477	3.6mm	292mm	Black	100
178-490	3.6mm	292mm	Natural	100
233-471	4.6mm	203mm	Black	100
811-1666	4.6mm	203mm	Black	100
811-1710	4.8mm	160mm	Natural	100
233-506	4.8mm	188mm	Black	100
178-484	4.8mm	188mm	White	100
489-2140	4.8mm	200mm	Natural	100
811-1697	4.8mm	250mm	Black	100
489-2156	4.8mm	295mm	White	100
233-487	4.8mm	300mm	Black	100
811-1650	4.8mm	300mm	Black	1000
811-1662	4.8mm	368mm	Black	1000
233-483	4.8mm	368mm	Black	100
178-507	4.8mm	368mm	Natural	100
811-1707	4.8mm	385mm	Natural	100
811-1688	7.6mm	300mm	Black	100
811-1684	7.6mm	340mm	Black	100
233-493	7.6mm	380mm	Black	100
811-1669	7.6mm	380mm	Black	1000
178-513	7.6mm	380mm	White	100
811-1678	8.0mm	450mm	Black	100
811-1672	9.0mm	610mm	Black	100
811-1681	9.0mm	762mm	Black	100
811-1675	12.7mm	550mm	Black	100
811-1701	12.7mm	550mm	Natural	100

Assorted Nylon Cable Tie Canister Pack

- Colours: Natural, Black, Red, Yellow, Blue, Green, Purple, Grey, Orange, Neon Yellow
- Flame retardant



233-118 100 x 2.5mm, Pack of 1000

TG Cable Tie Tools

- Quickly tensions and automatically cut cable ties
- Flush tie cut-off eliminates sharp edges for safety



811-1732 1.8 - 4.8mm

811-1735 2.5 - 10.0mm

Cable Tie Installation Pliers

- A hand-operated plier for tightening and trimming cable ties up to 5 mm width
- Tension and manually cut cable ties
- Suitable for use with all standard cable ties



549-909 Up to 5mm

WALL BOXES & ACCESSORIES

Protect your critical components with RS PRO's range of durable enclosures and wall boxes, designed for optimal organisation and safety in challenging environments.

Top Hat DIN Rail

- A selection of robust TS-35 standard DIN rails used for mounting various electrical and industrial equipment.
- Manufactured from cold rolled steel which is then zinc coated and clear passivated.
- This ensures its strength and corrosion proof properties.
- Un-slotted profiles and available in various lengths for easy attachment and wiring.



467-416 Slotted, 1m x 35 mm x 7.5 mm, 6mm hole size

467-400 Unslotted, 2m x 35mm x 7.5mm

DIN Rail Mounting Square Brackets, TS Series

- Zinc coated steel snap-on mounting brackets with a M6 tapped holes
- Fits all TS35 top hat mounting rails.
- Zinc coated mild steel
- Sold in a Pack of 10



467-383 Square bracket, 20mm height

467-343 Square bracket, 40mm height

467-361 Square bracket, 70mm height

467-371 Square bracket, 90mm height

Drain Plug

- Polycarbonate plug
- Can be fixed to panels and equipment to enable the drain plug to be mounted and de-mounted from outside of the equipment.
- Incorporates a filter to drain liquids from an enclosure at 30cc/min whilst preventing dust, dirt etc. from entering the enclosure



838-827 Black

Air Vents

- Ideal for regulating air circulation and temperature control
- Suitable for a variety of applications
- Easy to install
- Rubber gasket with IP54 protection



192-7137 White, 50mm x 15.8mm x 68mm

192-7136 White, 28.45mm x 21.88mm x 25.75mm

Insulated ABS Wall Boxes

- A high quality insulated wall mount enclosure designed for outdoor applications and harsh environments
- Constructed of ABS material which gives a smooth, high gloss finish, with good resistance to chemical attack and excellent insulating properties
- 200° door opening
- Temperature rating -25 to +60°C
- RoHS compliant with IP65 protection



**IP65
RATED**

746-7393	280 x 210 x 130 mm
746-7396	400 x 300 x 165 mm
746-7390	400 x 300 x 195 mm
746-7400	500 x 400 x 175 mm
746-7403	600 x 400 x 200 mm

Stainless Steel Wall Box with Chassis Plate

- IP66 wall box
- Constructed from 1.2 mm AISI 304 natural finish stainless steel
- Plain door with single lock
- IK10 protection against mechanical impacts
- Zinc coated 1.5 mm steel chassis plate

**IP66
RATED**

Sheet Steel Wall Boxes

- Providing IP66 and IK10 protected
- Polyester epoxy powder coat textured finish RAL 7032
- Enclosure and door made from sheet steel either 1.2 mm or 1.5 mm thick (depending on size)
- Mounting plate is made from zinc-coated steel either 1.5 mm or 2.0 mm (depending on size)

**IP66
RATED**

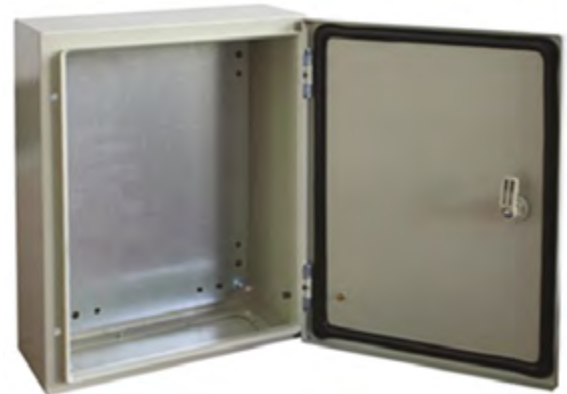

842-8406	300 x 300 x 150 mm
842-8370	300 x 300 x 200 mm
842-8361	300 x 400 x 150 mm
842-8342	300 x 400 x 200 mm
842-8380	400 x 300 x 150 mm
842-8383	400 x 300 x 200 mm
842-8392	400 x 400 x 150 mm
842-8409	400 x 400 x 200 mm

775-5300	300 x 250 x 150 mm
775-5319	300 x 300 x 210 mm
775-5312	300 x 400 x 210 mm
775-5316	400 x 300 x 210 mm
775-5325	400 x 400 x 210 mm
775-5328	400 x 600 x 210 mm
775-5322	500 x 400 x 210 mm
775-5331	500 x 500 x 210 mm
775-5334	500 x 500 x 300 mm
775-5788	300 x 200 x 150 mm
775-5791	300 x 300 x 150 mm
775-5794	300 x 400 x 200 mm
775-5798	400 x 300 x 150 mm
775-5808	400 x 300 x 200 mm
775-5801	400 x 400 x 200 mm

Rear mount Door Interlocked Isolator

- Rear of panel mounting isolators complete with handle and shaft with AC-22 rating
- The switch mounts at the rear of the enclosure, either on 35mm DIN rail or via two screw fixing
- The handle is interlocked ensuring removal only in the OFF position, and is padlockable in the OFF position
- Maximum panel thickness is 3mm
- Metal shaft length: 282mm (3 pole) and 94mm (6 pole)



IP65 RATED

Metal Clad Enclosed Isolators

- Enclosed isolators in RAL7032 grey epoxy coated steel with IP54 protection
- Padlockable handle
- Choice of 3 or 4 pole configuration with the optional auxiliary contacts - see 466-251

IP54 RATED



466-176	32A 3 Pole
466-273	25A 3 Pole
466-283	40A 3 Pole
466-277	63A 3 Pole
466-267	80A 3 Pole
466-160	125A 3 Pole

Plastic Boxed Electrical Isolators

- Electrical isolators in IP65 sealed housings with padlockable handles for added safety
- M20 gland positions (must be drilled out) on sides



IP65 RATED

466-249	4 Pole, 7.5kW, 20A
466-233	25A 4 Pole
466-227	32A 4 Pole
466-172	3 Pole, 11kW, 32A
466-239	40A 4 Pole
466-223	63A 4 Pole
466-217	80A 4 Pole

773-8002	25A 3 Pole
773-8011	32A 3 Pole
773-8014	40A 3 Pole
773-8018	63A 3 Pole
773-8027	80A 3 Pole
773-8020	25A 4 Pole
773-8024	32A 4 Pole
773-8033	40A 4 Pole
773-8036	63A 4 Pole
773-8030	80A 4 Pole
773-8049	100A 4 Pole
773-8042	125A 4 Pole

Panel Mount (Padlockable)

- Panel mount switch disconnectors for use with low voltage switchgear such as power distribution, load isolation and motor start/stop
- All switch ratings at AC-22
- Maximum panel thickness 3mm
- Actuator dimensions 64x64x32mm



466-148	25A 3 Pole
466-150	32A 3 Pole
466-138	63A 3 Pole

Large Box Enclosed Isolators

- Plastic IP65 enclosed isolators in an over-sized box to aid wiring when space isn't an issue
- Ideal if working with steel wire armoured cable or conduit
- Interlocking lid ensures removal in the OFF position only
- Padlockable handles
- Flame retardant material



466-122	100A 4 Pole
466-132	125A 4 Pole

IP65 RATED

Enclosed Change-Over Switches

- ABS plastic enclosed 2 pole changeover switch with padlockable handle
- IP65 protected
- AC-21 Rated

IP65 RATED



860-9554	25A 2 Pole
860-9557	32A 2 Pole
860-9551	40A 2 Pole

Axial Fan Square Fitting

- RS brushless high performing ball bearing fans provide a general purpose, compact, cost-effective and reliable solution to a variety of requirements
- Black construction



Stock No.	Dimensions	Supply Voltage	Air Flow	Power Consumption
619-6804	120 x 120 x 38mm	230Vac	187m ³ /h	15W
619-6775	120 x 120 x 38mm	115Vac	187m ³ /h	15W
619-6905	180 x 180 x 89mm	115Vac	637.5m ³ /h	70W
619-6933	180 x 180 x 89mm	230Vac	637m ³ /h	70W
619-7015	80 x 80 x 38mm	230Vac	52.7m ³ /h	12W
541-4965	60 x 60 x 25mm	12 dc	30.6m ³ /h	1.7W
541-5227	60 x 60 x 25mm	24 V dc	30.6m ³ /h	1.9W
541-4987	60 x 60 x 25mm	12Vdc	40.8m ³ /h	2.8W
668-8827	60 x 60 x 25mm	12Vdc	42.5m ³ /h	2.8W
541-5249	60 x 60 x 25mm	24Vdc	40.8m ³ /h	3.5W
541-5003	80 x 80 x 15mm	12Vdc	39.1m ³ /h	1.8W
541-5025	80 x 80 x 15mm	12Vdc	51m ³ /h	2.3W
541-5255	80 x 80 x 15mm	24Vdc	32.3m ³ /h	2.4W
541-5277	80 x 80 x 15mm	24Vdc	51m ³ /h	4.6W
541-5283	80 x 80 x 25mm	24Vdc	48m ³ /h	0.96W
541-5299	80 x 80 x 25mm	24Vdc	56.07m ³ /h	1.67W
541-5306	80 x 80 x 25mm	24Vdc	68m ³ /h	2.41W
541-5328	92.5 x 92.5 x 25mm	24Vdc	74.8m ³ /h	2.9W
703-3458	92.5 x 92.5 x 38mm	48Vdc	229.5m ³ /h	17W

Plastic Finger Guards

- Suitable for use with axial fans



737-4055	120mm, Pack of 10
737-4049	60mm, Pack of 10

Axial Fan Round Fitting - AC

- Die cast Aluminium frame
- 60,00 hours life time
- Dual Ball Bearing



619-6848	172 (Dia.) x 51mm, 399.5m ³ /h, 35W, 230Vac
619-6860	172 (Dia.) x 51mm, 510m ³ /h, 50W, 230Vac
619-6832	172 (Dia.) x 51mm, 399.5m ³ /h, 35W, 115Vac stadium
619-6927	254 (Dia.) x 88.9mm, 547m ³ /h, 35W, 115Vac
619-6949	254 (Dia.) x 88.9mm, 929m ³ /h, 35W, 230Vac

Sealed Sleeve Axial Fan

- Sealed sleeve technology retains bearing lubricant
- Long life expectancy (more than 50,000 hours)
- Black construction



668-8801	40 x 40 x 10mm, 11.4m ³ /h, 1.4W, 24Vdc
789-7867	50 x 50 x 10.5mm, 19m ³ /h, 1.44W, 12Vdc
541-5182	60 x 60 x 15mm, 20.4m ³ /h, 1.2W, 24Vdc
541-5198	60 x 60 x 15mm, 23.8m ³ /h, 1.7W, 24Vdc
541-5205	60 x 60 x 15mm, 32.3m ³ /h, 2.2W, 24Vdc

Metal Finger Guards

- Steel wire with welded joints withstands 220 lbs separation force to meet UL/CUL standards



619-6911	Chrome 180mm
737-4020	Chrome 225mm, Pack of 5
619-7021	Chrome 254mm

Round Top Nylon 66 Cable Gland

- UL listed Nylon 66 material
- Simple and easy to use
- IP68 protection
- PG thread to DIN standard with washer assembled
- Available in a range of colours and thread sizes

**IP68
RATED**



Stock No.	Thread Size	Colour	Pack Size
822-9666	PG7	Black	10
822-9640	PG7	Grey	10
822-9675	PG9	Black	10
822-9644	PG9	Grey	10
822-9678	PG11	Black	10
822-9653	PG11	Grey	10
822-9672	PG13.5	Black	10
822-9656	PG13.5	Grey	10
822-9681	PG16	Black	10
822-9650	PG16	Grey	10
822-9684	PG21	Black	10
822-9669	PG21	Grey	10
822-9688	PG29	Black	10
822-9662	PG29	Grey	10

Nylon Locknuts

- A selection of 1.5 mm pitch Metric locknuts
- Threads Metric Conduit BS3643
- Complies with EU Directive 2002/95/EC-ROHS
- Complies with EU Directive 2002/96/EU Waste Electrical Equipment-WEEE



Stock No.	Thread Size	Colour	Material	Pack
127-259	M16	Black	PA 6	25
127-417	M20	Black	PA 6	25
127-653	M25	Black	PA 6	25

Metric Dome Top Gland

- Supplied complete with locknut and entry thread seal.
- Manufactured from UL approved Nylon 66
- Flammability rating to UL 94V-2
- Provides watertight seal to IP68
- Offers strain relief and protection for cables

**IP68
RATED**



Stock No.	Thread Size	Colour	Pack Size
669-4667	M16	Black	5
669-4676	M25	Black	5
669-4670	M32	Black	5
669-4689	M40	Black	5
669-4658	M12	Black	100
669-4682	M50	Black	5
669-4654	M12	Black	5
669-4673	M20	Black	5
669-4660	M20	Black	5
669-4664	M20	Black	5
669-4686	M63	Black	5

Round Top Nylon 66 Cable Gland

- UL listed Nylon 66 material
- Simple and easy to use
- IP68 protection
- PG thread to DIN standard with washer assembled
- Available in a range of colours and thread sizes

**IP68
RATED**



Stock No.	Thread Size	Colour	Pack Size
822-9739	M12 x 1.5	Grey	10
822-9748	M16 x 1.5	Grey	10
822-9741	M20 x 1.5	Grey	10
822-9757	M20S x 1.5	Grey	10
822-9745	M25 x 1.5	Grey	10
822-9751	M25S x 1.5	Grey	10
822-9754	M32 x 1.5	Grey	10
822-9767	M16 x 1.5	White	10
822-9776	M20 x 1.5	White	10
822-9782	M20S x 1.5	White	10
822-9779	M25 x 1.5	White	10
822-9785	M25S x 1.5	White	10
822-9773	M32 x 1.5	White	10
822-9789	M20 x 1.5	Red	10
822-9798	M25 x 1.5	Red	10
822-9763	M25S x 1.5	Black	10

Cable Gland Selection Chart

Use the table below to assist in gland size selection for your cable.

The gland sizes recommended in this chart are for guidance only and are based on cables manufactured to BS 5467.

We advise that the most accurate way to select your gland is based on the measurement of your cable.

CABLE SIZE MM	SINGLE CORE	NUMBER OF CORES											
		2	3	4	5	7	10	12	19	27	37	48	
1.5	N/A	20S	20S	20S	20S	20S	20	20	25	32	32	32	
2.5	N/A	20S	20S	20S	20S	20	25	25	25	32	40	40	
4	N/A	20S	20S	20	20	25	25	32	32	40	40	50	
6	N/A	20	20	20	20	25	32	-	-	-	-	-	
10	N/A	20	25	25	25	32	32	-	-	-	-	-	
16	N/A	25	25	25	25	32	-	-	-	-	-	-	
25	N/A	25	25	32	32	40	-	-	-	-	-	-	
35	N/A	32	32	32	40	-	-	-	-	-	-	-	
50	20	25	32	32	50	-	-	-	-	-	-	-	
70	20	32	32	40	50	-	-	-	-	-	-	-	
95	25	32	40	50S	-	-	-	-	-	-	-	-	
120	25	40	50S	50	-	-	-	-	-	-	-	-	
150	32	40	50S	50	-	-	-	-	-	-	-	-	
185	32	50S	50	63S	-	-	-	-	-	-	-	-	
240	32	50	63S	63	-	-	-	-	-	-	-	-	
300	40	63S	63	75S	-	-	-	-	-	-	-	-	
400	40	63S	75S	75	-	-	-	-	-	-	-	-	

Strain Relief Cable Glands

- Designed with strain relief protection
- UL listed Nylon 66 material
- Protects cables from breakage and right angle bending
- Sealing to IP68
- Available in black or grey in a range of thread sizes



Cable Gland Adaptors

- Enable switching from small metric external thread to large metric
- UL approved Nylon 66 material



Stock No.	Thread Size	Colour	Pack Size
822-9631	M12 x 1.5	Black	10
822-9634	M16 x 1.5	Black	10
822-9638	M16 x 1.5	Black	10
822-9647	M16 x 1.5	Black	10
822-9616	M12 x 1.5	Grey	10
822-9625	M16 x 1.5	Grey	10
822-9628	M16 x 1.5	Grey	10
822-9622	M16 x 1.5	Grey	10
822-9593	PG7	Black	10
822-9603	PG9	Black	10
822-9606	PG11	Black	10
822-9600	PG13.5	Black	10
822-9619	PG16	Black	10
822-9612	PG21	Black	10
822-9571	PG7	Grey	10
822-9580	PG9	Grey	10
822-9583	PG11	Grey	10
822-9587	PG13.5	Grey	10
822-9596	PG16	Grey	10

Stock No.	Type	Thread Size	Colour
822-9861	Enlarger	M12x1.5 to M16x1.5	Black
822-9864	Enlarger	M16x1.5 to M20x1.5	Black
822-9877	Enlarger	M25x1.5 to M32x1.5	Black
822-9868	Enlarger	M20x1.5 to M25x1.5	Black
822-9846	Enlarger	M12x1.5 to M16x1.5	Grey
822-9855	Enlarger	M16x1.5 to M20x1.5	Grey
822-9858	Enlarger	M20x1.5 to M25x1.5	Grey
822-9852	Enlarger	M25x1.5 to M32x1.5	Grey
822-9870	Reducer	M16x1.5 to M12x1.5	Black
822-9874	Reducer	M20x1.5 to M16x1.5	Black
822-9883	Reducer	M25x1.5 to M20x1.5	Black
822-9886	Reducer	M32x1.5 to M25x1.5	Black
822-9880	Reducer	M16x1.5 to M12x1.5	Grey
822-9899	Reducer	M20x1.5 to M16x1.5	Grey
822-9892	Reducer	M25x1.5 to M20x1.5	Grey
822-9896	Reducer	M32x1.5 to M25x1.5	Grey
817-8889	Converter	PG11x8 - M16x1.5	Black
817-8883	Converter	PG13.5x8 - M16x1.5	Black
817-8886	Converter	PG9x8 - M16x1.5	Black

PVC Cable Trunking

- Self-extinguishing to UL94-V2
- Warp-proof PVC with a slot gap of 8mm
- Available in 1 or 2m lengths
- Open or Narrow slot



Stock No.	Colour	Material	Slot	W	H	Length
301-2084	Black	PVC	8mm	25mm	30mm	2m
301-2107	Black	PVC	8mm	40mm	40mm	2m
301-2129	Black	PVC	8mm	50mm	50mm	2m
136-9146	Grey	PVC	5mm	25mm	25mm	2m
136-9155	Grey	PVC	5mm	75mm	75mm	2m
879-3753	Grey	PVC	4mm	80mm	80mm	1m
879-3741	Grey	PVC	4mm	40mm	60mm	1m
879-3747	Grey	PVC	4mm	40mm	80mm	1m
879-3750	Grey	PVC	4mm	60mm	80mm	1m
758-9260	Grey	PVC	8mm	15mm	25mm	2m
758-9272	Grey	PVC	8mm	25mm	40mm	2m
758-9276	Grey	PVC	8mm	25mm	60mm	2m
758-9288	Grey	PVC	8mm	40mm	40mm	2m
758-9282	Grey	PVC	8mm	40mm	60mm	2m
758-9291	Grey	PVC	8mm	40mm	80mm	2m
879-3725	Grey	PVC	8mm	40mm	40mm	1m
879-3731	Grey	PVC	8mm	40mm	60mm	1m
879-3738	Grey	PVC	8mm	40mm	80mm	1m
879-3744	Grey	PVC	8mm	60mm	80mm	1m
879-3735	Grey	PVC	8mm	80mm	80mm	1m
879-3713	Grey	PVC	8mm	25mm	25mm	1m
879-3722	Grey	PVC	8mm	60mm	60mm	1m
879-3729	Grey	PVC	8mm	100mm	100mm	1m
301-1924	Grey	PVC	8mm	25mm	25mm	2m
301-1946	Grey	PVC	8mm	45mm	33mm	2m
301-1930	Grey	PVC	8mm	45mm	25mm	2m
301-1974	Grey	PVC	8mm	50mm	50mm	2m
301-1968	Grey	PVC	8mm	45mm	45mm	2m
301-1980	Grey	PVC	8mm	65mm	25mm	2m
301-2006	Grey	PVC	8mm	60mm	60mm	2m
301-2012	Grey	PVC	8mm	65mm	65mm	2m
301-1996	Grey	PVC	8mm	65mm	45mm	2m
301-2056	Grey	PVC	8mm	100mm	75mm	2m
301-2062	Grey	PVC	8mm	100mm	100mm	2m

Halogen Free DIN Panel Grey Trunking

- Halogen free and flame retardant
- It doesn't release any corrosive or toxic gases
- Rigid PVC cable trunking
- Break points on bars and channel floor
- Available in 2 metre lengths



136-9160 W25XH25

136-9169 W50XH75

Electro-galvanised steel Cable Tray Fast Coupler

- Electro-welded, electro-galvanised steel construction

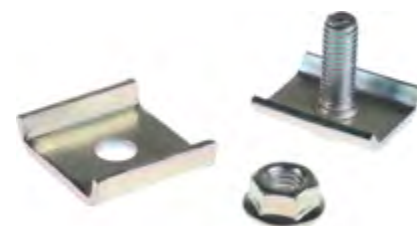

912-4710 Bag of 100

Flexible Self-Adhesive Slotted Trunking

- Polypropylene halogen free flexible slotted trunking
- Provided with strong self adhesive backing
- Round shape, low flammability and self extinguishing in accordance with UL94-V1
- Operating temperature range of -20°C to +70°C



598-591 500x11x9mm

598-608 500x20mm

598-614 500x30mm

PVC Spiral - Contractor Pack

- Good general purpose PVC conduit with a unique IP67 dual purpose connector (fixed or swivel).
- Self-extinguishing according to UL94-V0
- Shock-resistance with smooth internal surface
- Compression strength D<25% with 350N at 20°C

**IP67
RATED**



513-2354 20mm
513-2360 25mm

Contractor Conduit Pack with Fittings & Locknuts

- Nylon conduit with quick and efficient IP66 push-on connectors - 10 straight fittings and 10 locknuts
- Self-extinguishing, halogen-free
- Resistant to fuels, mineral oils, lubricants, alkalis and most commercial solvents

**IP66
RATED**



513-2376 20mm

Flexible Conduit

- Flame retardant, general purpose conduit
- Resilient to prolonged flexing and vibration
- IP55 conduit (when used with compatible fittings)
- Crush resistant to BS6099
- Resistant to: nitric acid, sulphuric acid, detergent, diesel and white spirit

**IP55
RATED**



429-688 10mm
429-672 20mm

Split Flexible Conduit

- For cable protection in electrical installations, machinery and buildings
- Special design allows bends around corners without kinking
- The split allows the conduit to be installed easily onto pre-installed wiring
- Colour: black



755-9013 16mm
875-0249 16mm, 100m
755-9017 20mm
875-0258 20mm, 100m
755-9026 25mm
755-9029 32mm

Nylon Fish Wire Draw Tape

- Draw tape with strong brass head
- Available in 10m and 20m lengths



918-4977 20m
918-4970 10m

Polypropylene Contractor Pack

- Low cost, black general-purpose conduit supplied in 10m lengths with 10 split fitting and 10 locknuts.

**IP66
RATED**



513-2332 20mm

Polyamide Terminal Blocks

- 12 way non-fused terminal block
Natural colour with a quick snap body
Screw down termination with a nickel plated brass contacts
Applications: Connecting lighting to switches, connecting wiring to a ground, HVAC Systems, Power Supplies
- Cross Section: rated for rigid wire and cables (if for flexible wire, it should be reduced one-step, i.e. 6mm² is 4mm² Φ 1 wire entry hole diameter Φ 2 fixing hole diameter



Stock No.	Colour	Cross Section	Current Range	Rated Voltage	Pack Size
492-8687	Natural	2.5mm ²	24A	380 V	5
492-8700	Natural	4mm ²	32A	400 V	5
492-8716	Natural	6mm ²	41A	400 V	5
840-7923	Natural	10mm ²	10-57A	450V	5
840-7960	Natural	6mm ²	41 A	450V	5
840-7954	Natural	1.5mm ²	17.5 A	450V	5
840-7929	Natural	2.5mm ²	2.5 ~ 20 A	450V	5
840-7951	Natural	4mm ²	32 A	450V	5
813-3136	Natural	12mm ²	15 - 61 A	400V	5
813-3127	Natural	10mm ²	10 - 57 A	400V	5
813-3139	Natural	16mm ²	30 - 76 A	400V	5
813-3123	Natural	6mm ²	5 - 32 A	380V	5
813-3120	Natural	4mm ²	3 - 24 A	380V	5

Polyethylene Terminal Blocks

- 12 way terminal blocks
- Brass inserts and galvanised steel screws
- Natural colour
- Temperature rating: 80°C
- Pack of 10



Stock No.	Colour	Cross Section	Temp	Current Range	Rated Voltage
763-8113	Natural	4mm ²	80° C	3~24 A	380V
763-8116	Natural	6mm ²	80° C	5 ~ 32 A	380V
867-0963	Natural	10mm	80° C	10 ~ 57A	400V
867-0972	Natural	12mm	80° C	15~61A	400V
867-0975	Natural	16mm	80° C	30~76A	400V
867-0979	Natural	25mm	80° C	60~101A	400V

Nylon Terminal Blocks With Wire Protection Leaf

- 12 way terminal blocks
- Natural Colour
- Screw Terminals
- Wire Protection Leaf



Stock No.	Cross Section	Temp	Current Rating	Rated Voltage
464-9722	4mm ²	125°C	41A	400 V
464-9738	2.5mm ²	125°C	24A	400 V
464-9700	10mm ²	125°C	50A	400 V
464-9744	2.5mm ²	125°C	41A	400 V

Polyamide Terminal Blocks(Horizontal Plug)

- 12 way non-fused terminal block
- Natural colour with a quick snap body
- Screw down termination with a nickel plated brass contacts
- Applications: Connecting lighting to switches, connecting wiring to a ground, HVAC Systems, Power Supplies



Stock No.	Cross Section	Temp	Current Range	Rated Voltage	Pack Size
865-9833	6mm ²	105o C	5 - 32A	450 V	1
865-9830	4mm ²	105o C	5 - 32A	450 V	1

Polypropylene Terminal Blocks

- Non-fused terminal block
- Lightweight, rigid, corrosion resistant and with high tensile strength
- Colour white
- Screw down terminals with brass contacts
- Pack of 5



Stock No.	Cross Section	Temp	Current Range	Rated Voltage	Pack Size
703-3814	2.5mm ²	-40°C - 85°C	6A	400 V	5
703-3818	4mm ²	-40°C - 85°C	24A	380 V	5
703-3827	6mm ²	-40°C - 85°C	20A	380 V	5

Commoning Terminal Blocks

- Compact design allows high-density connections
- Housing material: transparent blue polycarbonate
- Self-extinguishing: UL 94 - V0; IEC 692-1 to 850°C; IEC 692-2
- Maximum operating temperature: 85°C
- Clamps: Brass, Captive screws: galvanized steel
- Protection degree: IP 20



868-0786	3 poles + prot
868-0774	5 poles + prot
868-0752	11 poles, 6-16
868-0792	6 poles 6-16
868-0799	6 poles 16-35
868-0806	3 poles 35
868-0755	4 poles 16

Porcelain Terminal Blocks

- Nickel plated brass inserts and galvanised steel screws
- Maximum operating temperatures: 800°C housing and 350°C inserts
- Hard and solid block material
- Non-flammable and resistant to chemicals



813-3117	10 mm ² , 1 Pole
813-3111	16 mm ² , 1 Pole
813-3101	16 mm ² , 4 Poles
813-3108	10 mm ² , 4 Poles
813-3114	4 mm ² , 1 Pole
813-3098	4 mm ² , 4 Poles
813-3105	4 mm ² , 3 Poles

Steatite Terminal Blocks

- Nickel-plated brass inserts and plated steel screws
- Suitable for use in high ambient temperatures up to 300°C
- High dielectric strength
- Non-flammable with dimensional stability up to 1000 °C
- Pack of 5



703-3846	2 ways 4mm ²
703-3858	2 ways 10mm ²
703-3861	2 ways 16mm ²
703-3855	3 ways 4mm ²
703-3852	3 ways 10mm ²
703-3864	3 ways 16mm ²

Brass Earth Terminal Blocks

- Earth connecting blocks manufactured from Brass to BS2498
- Width 19mm, Height 12mm
- Sold in a Pack of 5



Stock No.	Block Type	Wire Size	No. of Ways	Termination Method	Pack Size
283-0730	Double Screw	0 - 16 mm ²	8	Screw Down	
425-544	Double Screw	0 - 16 mm ²	4	Screw Down	
283-0746	Double Screw	0 - 16 mm ²	5	Screw Down	
283-0768	Double Screw	0 - 16 mm ²	6	Screw Down	
425-550	Double Screw	0 - 16 mm ²	8	Screw Down	
867-0991	CE (BS EN 60998)	0 - 16 AWG	3	Screw Down	
867-1004	CE (BS EN 60998)	0 - 16 AWG	5	Screw Down	
867-1007	CE (BS EN 60998)	0 - 16 AWG	8	Screw Down	

Standard Din Rail Terminals

- Identify signals or voltages easily due to colour coding
- Standards met: UL, CSA, NEMKO, GOST
- Sold in a Packs of 14



Stock No.	Cable CSA	Colour	Voltage Rating	Current Rating
501-730	0.2 - 2.5mm ²	Orange	800V	24A
501-639	0.2 - 2.5mm ²	Black	800V	24A
501-613	0.2 - 2.5mm ²	White	800V	24A
501-641	0.2 - 2.5mm ²	Yellow	800V	24A
501-645	0.2 - 2.5mm ²	Black	800V	24A
501-720	0.2 - 4mm ²	Brown	800V	32A
501-803	0.2 - 4mm ²	Grey	800V	32A
501-673	0.2 - 4mm ²	Red	800V	32A
501-932	0.2 - 4mm ²	White	800V	32A
501-651	0.2 - 4mm ²	Orange	800V	32A
501-663	0.2 - 4mm ²	Yellow	800V	32A
815-666	2.5 - 4mm	Beige	800 V	40A
815-672	2.5 - 4mm	Blue	800 V	40A
501-976	0.2 - 2.5mm ²	Black	800V	24A
501-821	0.2 - 2.5mm ²	Red	800V	24A
802-783	0.2 - 2.5mm ²	Blue	800V	24A
501-635	0.2 - 2.5mm ²	Brown	800V	24A

DIN Rail Screw Clamp Terminal Blocks (CDU Series)

- Suitable for a broad range of cross-section and wire types
- Excellent vibration resistance with very low contact resistance
- High reliability and maintenance free
- Easy mounting and dismounting from DIN rail



Stock No.	Cable CSA	Colour	Voltage Rating	Pack Size
878-7503	2.5mm ²	Beige	800V	10
878-7506	2.5mm ²	Grey	800 V	10
878-7487	2.5mm ²	Grey	800 V	10
878-7496	2.5mm ²	Black	800 V	10
878-7499	2.5mm ²	Blue	800 V	10
913-1207	2.5mm ²	Orange	800 V	10
913-1201	2.5mm ²	Red	800 V	1
878-7522	4mm ²	Blue	800 V	10
878-7528	4mm ²	Black		10
878-7525	4mm ²	Grey		10
878-7519	4mm ²	Grey	800 V	10
913-1210	4mm ²	Blue	800 V	1
878-7534	6mm ²	Grey	800 V	10
913-1213	10mm ²	Grey	600V	10
913-1217	16mm ²	Grey	600V	10

2 Way DIN Rail Earth Block

- Screw connection DIN rail mounted earth terminal blocks
- Green/yellow earth colour coding
- Wires can be connected without any special preparation
- Sold in a Pack of 5



Stock No.	Block Type	Wire Size	No. of Ways	Termination Method	Pack Size
878-7562	DIN Rail	26 - 12 AWG	2	Screw	5
878-7575	DIN Rail	26 - 10 AWG	2	Screw	5
878-7566	DIN Rail	26 - 10 AWG	2	Screw	5
878-7569	DIN Rail	26 - 12 AWG	2	Screw	5
878-7578	DIN Rail	26 - 8 AWG	2	Screw	5
815-773	Top Hat	22 - 11 AWG	2	Screw Down	5

High Current Terminals (WKN Series)

- Grey screw down termination, single level
- Fingerproof terminals (to VBG4 requirements)
- Flammability rating UL 94-V0
- Sold in a Pack of 5



384-6988	10mm ² , 1kV, 57A
384-6994	16mm ² , 1kV, 71A

High-Power Stud Terminals

- 1000V
- Foot can be snapped on TS 35 DIN rail
- Housing made from polyamide 6.6 UL 94-V0



872-4824	125A M6
872-4833	192A M8
872-4836	269A M10
872-4849	520A M16

End Stops/End Brackets

- Provide a secure mechanical stop on DIN rail



501-972 Pack of 10

Screw Down End Stop

- End stops are necessary for preventing movement of components along the rail.
- Depending on the DIN rail, they differ in the dimensions of the mounting foot and their screw-on or snap-on design.
- Material: PA 6.6V2 for TS 32 DIN rail
- Terminal width: 8mm



872-5637 Pack of 10

Modular DIN Rail Mounted Distribution Block

- For control panels and distribution.
- Housing material: Polycarbonate (PC)
- Fixing: On DIN rail conforming to EN 50022 or mounted via fixing screws



868-0736 26 Way, Blue

Test Adaptor

- A test adaptor which enables DIN rail mounted terminals to accept 4mm test leads.
- The adaptor screws into the terminal current bar and projects above the terminal to accept both shrouded and unshrouded 4mm plugs.
- The test adaptor precludes the use of jumper bars and may be permanently fitted to the terminals detailed, enabling easy hands free measurements.
- Voltage and current rating determined by the mating plug.



452-164 Pack of 5

Fuse Kits

- Each fuse kit contains 180 Fuses in a Segmented Flip-Lid Box.
- For easy ordering fuse replacement references on inside lid
- All fuses at a voltage rating of 250V
- 10pcs each current rating



Stock No.	Size	Voltage Rating
893-8537	5x20mm	90 x Slow (0.5A, 1A, 2A, 3.15A, 4A, 5A, 6.3A, 10A and 16A) & 90 x Fast - 250mA, 500mA, 1A, 1.6A, 2A, 3.15A, 5A, 6.3A and 10A
893-8530	5x20mm	90 x Fast Acting (250mA, 500mA, 1A, 1.6A, 2A, 3.15A, 5A, 6.3A, 10A) & 90 x Slow Blow (0.5A, 1A, 1.6A, 2A, 3.15A, 5A, 6.3A, 10A, 16A)
893-8534	6.3 x 32mm	90 x Fast acting (500mA, 1A, 1.6A, 2.5A, 3A, 5A, 6.3A 10A & 16A) & 90 x Slow acting (1A, 1.6A, 2A, 3.15A, 5A, 6.3A, 10A 16A & 20A)
893-8543	6.3x32mm	90 Fast Acting (1A, 2A, 3A, 5A, 6.3A, 10A, 12.5A, 16A, 20A) & 90 Slow Blow (0.63A, 1A, 1.6A, 2A, 5A, 6.3A, 10A, 16A, 20A)
893-8546	5x20mm	60 Fast Acting (500mA, 1A, 2A, 2.5A, 3.15A, 5A), 90 Slow Acting (1A, 1.25A, 1.6A, 2A, 2.5A, 3.15A, 5A, 6.3A, 10A), 30 x 1.0" (25mm) Uk main fuses 3A, 5A, 13A

Fuse Kit - Mixed Sizes

- Robust case with removable compartments
- 90 fuses of various sizes
- Supplied with:
- 5x20mm T1A, T2A, T3.15, F500mA, F1A, F1.6A, F2A, F2.5A, F3.15A, F4A, F5A, F6.3A, F10A
- 6.3x32mm F1A, F2A, F5A, F10A



918-2697 Fuse Kit - 20mm & 32mm

Fuse Kit - 5x20mm

- Handy compartmented carry case with 22 different fuse types all in 5x20mm size
- HBC in time delay only - 1, 2, 3.15, 5, 10A
- LBC in fast, time delay and semi-delayed



420-268 Fuse Kit - 5x20mm - HBC & LBC

General Purpose Fuse Kit - Mixed

- Kit containing HBC & LBC ceramic fuses in 5x20mm, 1.0" BS1363 (25mm) and 6.3x32mm sizes
- 1.0A to 15A - see online for full kit details



420-252 Fuse Kit - Mixed size

Fuse Kit - 5x20mm

- Assortment of 360 5x20mm fuses with fast, time-delay or semi-timed action
- 18 compartments of 20 fuses
- Values: 100 mA; 125 mA; 160 mA; 200 mA; 250 mA; 315 mA; 400 mA,
- 500 mA; 630 mA; 800 mA; 1 A; 1.25 A; 1.6 A; 2 A; 2.5 A; 3.15 A; 4A; 6.3 A



611-8955 Fuse Kit - 5x20mm

Inspection Joints

- Elbows and Tees in malleable iron with various finishes
- Covers and screws come supplied as standard
- Galvanised steel



763-9210 20mm nominal size, Pack of 5

Coupler

- Galvanised steel coupler for conduit
- Sold in pack of 25



606-030 20mm

606-046 25mm

Reducer Cable Conduit Fitting

- Steel reducer with enamelled finish

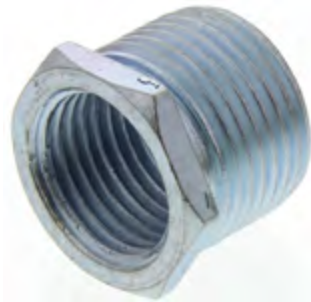

619-979 20/16mm

608-216 25/20mm

Pattern Bush

- Brass



608-244 Long Male Bush, 20mm

619-985 Long Male Bush, 25mm

608-222 Short Male Bush, 20mm

608-238 Short Male Bush, 25mm

Nickel Plated Brass Locknuts

- A selection of 1.5 mm pitch nickel plated brass locknuts
- Metric threads to EN60423
- Complies with EU Directive 2002/95/EC-ROHS
- Complies with EU Directive 2002/96/EU Waste Electrical Equipment-WEEE



127-164 M16 3.5mm

127-489 M25 3.5mm

127-495 M32 5mm

127-473 M20 3.5mm

Galvanised Steel Locknuts

- A selection of 1.5mm pitch steel locknuts
- Suitable for use with all ISO threaded conduit fittings and accessories
- Ideal for general electrical installation



621-102 M16x2.87mm

621-118 M20x2.87mm

Milled Edge Steel Lockring

- Lock Ring
- Steel
- BS EN 50086
- Sold in pack of 50



607-982 20mm, Pack of 50

607-998 25mm, Pack of 50

FACTORY AUTOMATION SENSORS

The range of RS PRO sensors ensures easy configuration and setup.

INDUCTIVE SENSOR: NPN OR PNP?

If your application requires an inductive sensor, you will need to decide what output type you require, NPN or PNP?

NPN Output:

NPN are sinking sensors, these allow current to flow into the sensor and to V-.

With an NPN sensor the switching occurs on the -V rail. The +V rail forms the common between the device and the sensor. A permanent +V supply will be connected to the device that is to be activated, for instance a PLC or relay. When the sensor turns on, it switches the -V rail and completes the circuit. Current travels through the sensor transistor into the device, thus turning it on or changing its state.

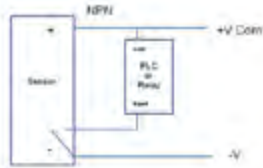

PNP Output:

PNP are sourcing sensors and allow current to flow out from the sensor, from V+.

With a PNP sensor the switching occurs on the +V rail. The -V rail forms the common between the device and the sensor. A permanent -V supply will be connected to the device that is to be activated, for instance a PLC or relay. When the sensor turns on, it switches the +V rail and completes the circuit. Current travels through the sensor transistor into the device, thus turning it on or changing its state.

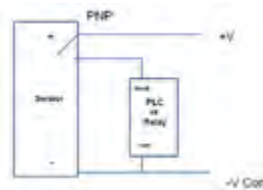

Remember

- If the DC voltage has a V+ common, an NPN output sensor is needed. If the DC voltage has a V- common, a PNP output sensor is needed.
- NPN or PNP output does not have correlation to whether the sensor is NO (normally open) or NC (normally closed) as both NPN and PNP can be either NO or NC.

Sensor Tester

- Handy battery powered proximity sensor tester ideal for checking 3 / 4 wire DC sensors while in place
- Supports NPN & PNP variants
- Supplied with batteries ready to use



Image for illustrative purposes only

839-9875 Proximity Switch LED and Audio

Barcode Scanner

- Ergonomic design to fit comfortably in the hand
- Can switch between automatic scanning or manual scanning via the trigger
- Perfect for scanning both physical labels and digital barcodes
- 360° scan angle ensuring quick and easy scanning
- 3 mil recognition accuracy
- USB interface allowing for quick and easy operation

**IP54
RATED**



206-7501 USB

Load Cell Sensors

- Load cells, often called load cell transducers, are crucial components in most industrial weighing systems. They are available in many different configurations and standards, depending on the intended application and environment.
- Among the various different types of load cells available, models and styles can be differentiated in two key ways: By the specific method they use to detect weight (compression load cells, tension load cells and other measurement types) or by the type of output signal generated (hydraulic load cells, piezoelectric load cells and various other configurations).



Image for illustrative purposes only

Stock No.	Force Measured	Measurement Range Min/max	Output Type	IP Rating	Max Voltage
204-2767	Compression	0.3 - 3kg	PNP	IP67	15V
204-2772	Compression		PNP	IP66	10V
204-2765	Compression	5 - 500kg	PNP	IP68	15V
204-2770	Compression	10 - 100kg	PNP	IP67	15V
204-2768	Compression	50 - 1000kg	PNP	IP66	15V
204-2764	Compression	50 - 1000kg	PNP	IP68	10V
204-2771	Compression	60 - 1200kg	PNP	IP67	15V
204-2766	Compression	500 - 3000kg	PNP	IP68	15V
204-2773	Compression & Tension	1 - 500kg	PNP	IP66	10V

Fibre Optic Sensors

- Fibre optic sensor with NPN output.
- Fibre optic sensors are a type of proximity sensor that has an optical fibre connected to a light source to allow for detection in tight spaces or where a small profile is beneficial.
- The optical fibre is a transparent fibre made of glass (silica) or plastic with a diameter slightly thicker than a human hair, this fibre transmits light between the two ends to produce an electrical signal.
- Compatible probes 896-7298 and 896-7285



Stock No.	Housing Material	Output Type	Supply Voltage	IP Rating
204-0681	Plastic	NPN	24V DC	IP54
204-0682	Plastic	PNP	24V DC	IP54

Inductive Sensors for Flush Mount

- Inductive sensors offer precise detection, long-term reliability and high accuracy
- The sensors are completely encapsulated, which greatly increases shock and vibration resistance and are flush mounted



Image for illustrative purposes only

IP67 RATED

Stock No.	Detection Range	Output Type	Housing Material	Terminal Type	Thread Size
206-6124	0.6mm	PNP NO	Stainless Steel	2m Cable	M4x0.5
206-6126	0.8mm	PNP NO	Stainless Steel	M8	M5x0.5
206-6127	0.8mm	PNP NO	Stainless Steel	2m Cable	M5x0.5
206-6128	1.5mm	PNP NO	Stainless Steel	M8	M5x0.5
206-6129	1.5mm	PNP NO	Stainless Steel	2m Cable	M5x0.5
206-6150	2mm	PNP NO	Brass Nickel Plated	M8	M8x1
206-6151	2mm	PNP NO	Brass Nickel Plated	M8	M8x1
206-6152	2mm	PNP NO	Brass Nickel Plated	2m Cable	M8x1
206-6154	2mm	PNP NO	Brass Nickel Plated	2m Cable	M8x1
206-6155	4mm	PNP NO	Brass Nickel Plated	M12	M12x1
206-6156	4mm	PNP NO	Brass Nickel Plated	M12	M12x1
206-6157	4mm	PNP NO	Brass Nickel Plated	2m Cable	M12x1
206-6162	8mm	PNP NO	Brass Nickel Plated	M12	M18x1
206-6158	8mm	NPN NO	Brass Nickel Plated	2m Cable	M12x1
206-6159	8mm	PNP NO	Brass Nickel Plated	M12	M12x1
206-6160	8mm	PNP NO	Brass Nickel Plated	2m Cable	M12x1
206-6161	8mm	PNP NO	Brass Nickel Plated	M12	M18x1
206-6163	8mm	PNP NO	Brass Nickel Plated	2m Cable	M18x1
206-6165	10mm	PNP NC	Brass Nickel Plated	2m Cable	M30x1.5
206-6164	20mm	PNP NO	Brass Nickel Plated	M12	M18x1
206-6166	38mm	PNP NO	Brass Nickel Plated	M12	M30x1.5
206-6167	38mm	PNP NO	Brass Nickel Plated	2m Cable	M30x1.5
206-6168	2mm	PNP NO	Plastic Vistal®	M8	-
206-6170	2mm	PNP NO	Plastic Vistal®	2m Cable	-
206-6171	3mm	PNP NO	Plastic Vistal®	M8	-
206-6172	3mm	PNP NO	Plastic Vistal®	2m Cable	-
206-6173	4mm	PNP NO	Plastic Vistal®	M8	-
206-6174	4mm	PNP NO	Plastic Vistal®	2m Cable	-
206-6176	20mm	PNP NO/NC	Plastic PA 66	M12	-
206-6177	20mm	PNP NO/NC	Plastic PA 66	Terminal	-
206-6178	20mm	PNP NO	Plastic PA 66	M12	-
206-6179	20mm	PNP NO	Plastic PA 66	Terminal	-
206-6180	40mm	PNP NO/NC	Plastic PA 66	M12	-
206-6181	40mm	PNP NO/NC	Plastic PA 66	Terminal	-
206-6182	40mm	PNP NO	Plastic PA 66	M12	-
206-6183	40mm	PNP NO	Plastic PA 66	Terminal	-

Proximity Photoelectric Sensors

Photoelectric sensors detect and measure physical objects or quantities by emitting a field or beam of electromagnetic radiation. An object is detected by measuring alterations in the return signal.

Through-beam sensors rely on two separate housings, one for the transmitter and one for the receiver. Retro-reflective photoelectric sensors have both the transmitter and receiver contained within the same housing but require a reflector opposite to the sensor. Diffuse sensors are easier to install as only one device has to be mounted. This is because the transmitter and receiver are contained within one housing.

APPLICATIONS

- Industrial Factories
- Distribution Warehouses
- Food and Beverage
- Automation
- Building Maintenance

MAIN ADVANTAGES

The basic function is to detect the presence or absence of objects or measure the distance to the object, there are 3 main types of photoelectric sensors which provide reliable detection, these are through-beam, retro-reflective and diffuse.

DETECTION TYPES

Diffuser Reflection sensors use reflection to detect the presence of objects. The sensor emits a light that is reflected by the object. The reflected light is detected by the sensor and the sensor switches.

Diffuse Reflection with background suppression Many diffuse reflection sensors come with background suppression that prevents faulty triggering caused by reflections in the environment.

Retro Reflection sensors contain the transmitter and receiver in one housing and are combined with a prismatic reflector. This reflector reflects the emitted light beam and if the light is interrupted by an object, the sensor switches. A polarisation filter prevents faulty switching caused by reflective surfaces in the environment.

Retro Reflection with polarisation filter Retro-reflection sensors with a polarisation filter prevent faulty switching caused by reflective surfaces in the environment. Dedicated reflectors are needed to turn the light beam, so it can be detected by the sensor.

Through Beam With Through Beam sensors, the transmitter and receiver are in two separate devices positioned directly opposite each other. The transmitter continuously sends light to the receiver. The receiver switches as soon as the light beam is disconnected by an object. Through beam sensors are more resistant to malfunctioning and offer very high sensing ranges.

Diffuse Reflection

- Uses the diffuse-reflective principle to detect the absence or the presence of an object by picking up the reflected infrared light energy from the object.
- Offers excellent anti-interference performance, along with high detection accuracy, ensuring confidence and reliability.
- Designed to be highly sensitive with high linearity and pinpoint accuracy for optimum performance with the reflector and receiver in one convenient housing.



**IP67
RATED**

Stock No.	Housing Material	Detection Range (mm)	Terminal Type	Output Type	Thread Size
204-3961	Brass Nickel Plated	150	2m Cable	NPN NO	M12x1
204-3962	Brass Nickel Plated	150	2m Cable	PNP NO	M12x1
204-3963	Brass Nickel Plated	150	M12	NPN NO	M12x1
204-3965	Brass Nickel Plated	150	M12	PNP NO	M12x1
204-3966	PBT	150	2m Cable	NPN NO	M12x1
204-3967	PBT	150	2m Cable	PNP NO	M12x1
204-3968	Brass Nickel Plated	400	2m Cable	NPN NO/NC	M18x1
204-3970	Brass Nickel Plated	400	M12	NPN NO/NC	M18x1
204-3969	Brass Nickel Plated	400	2m Cable	PNP NO/NC	M18x1
204-3971	Brass Nickel Plated	400	M12	PNP NO/NC	M18x1
204-3972	PBT	400	2m Cable	NPN NO/NC	M18x1
204-3973	PBT	400	2m Cable	PNP NO/NC	M18x1
204-3974	PBT	400	M12	NPN NO/NC	M18x1
204-3975	PBT	400	M12	PNP NO/NC	M18x1
204-3976	Brass Nickel Plated	1000	2m Cable	NPN NO/NC	M30x1.5
204-3977	Brass Nickel Plated	1000	2m Cable	PNP NO/NC	M30x1.5
204-3979	PBT	1000	2m Cable	PNP NO/NC	M30x1.5

Background Suppression M18x0

- Uses the background suppression (BGS) sensor principle to detect the absence or the presence of an object, making it ideal for use on conveyor belts
- This method of detection prevents any background object, for example, the conveyor belt, beyond a set distance from being detected
- The sensor offers excellent anti-interference performance, along with high detection accuracy, ensuring confidence and reliability



**IP67
RATED**

Image for illustrative purposes only

Stock No.	Housing Material	Detection Range (mm)	Terminal Type	Output Type
204-4013	Brass Nickel Plated	1000	2m Cable	PNP NO/NC
204-4014	Brass Nickel Plated	1000	2m Cable	NPN NO/NC
204-4015	Brass Nickel Plated	1000	M12	PNP NO/NC
204-4016	Brass Nickel Plated	1000	M12	NPN NO/NC

Through Beam Emitter / Receiver

- Uses the through-beam sensor principle to detect the absence or the presence of an object
- The emitter and receiver are installed opposite each other so that it enables the light beam from the emitter to access the receiver, meaning when a passing object interrupts the light source between the two parts, it reduces the amount of light that is detected by the receiver
- The sensor offers excellent anti-interference performance, along with high detection accuracy, ensuring confidence and reliability



**IP67
RATED**

Image for illustrative purposes only

Stock No.	Detection Type	Housing Material	Detection Range (mm)	Terminal Type	Output Type	Thread Size
204-3990	Through Beam (Emitter)	Brass Nickel Plated	5000	2m Cable	-	M12x1
204-3991	Through Beam (Receiver)	Brass Nickel Plated	5000	2m Cable	NPN NO	M12x1
204-3993	Through Beam (Receiver)	Brass Nickel Plated	5000	2m Cable	PNP NO	M12x1
204-3994	Through Beam (Emitter)	Brass Nickel Plated	10000	2m Cable	-	M18x1
204-3995	Through Beam (Receiver)	Brass Nickel Plated	10000	2m Cable	NPN NO/NC	M18x1
204-4000	Through Beam (Receiver)	PBT	10000	2m Cable	-	M18x1
204-4001	Through Beam (Emitter)	PBT	10000	2m Cable	NPN NO/NC	M18x1
204-3996	Through Beam (Receiver)	Brass Nickel Plated	10000	2m Cable	PNP NO/NC	M18x1
204-3997	Through Beam (Receiver)	Brass Nickel Plated	20000	2m Cable	-	M18x1
204-3998	Through Beam (Emitter)	Brass Nickel Plated	20000	2m Cable	NPN NO/NC	M18x1
204-3999	Through Beam (Receiver)	Brass Nickel Plated	20000	2m Cable	PNP NO/NC	M18x1
204-4003	Through Beam (Receiver)	PBT	10000	2m Cable	PNP NO/NC	M18x1
204-4004	Through Beam (Emitter)	PBT	20000	2m Cable	-	M18x1
204-4005	Through Beam (Receiver)	PBT	20000	2m Cable	NPN NO/NC	M18x1
204-4006	Through Beam (Receiver)	PBT	20000	2m Cable	PNP NO/NC	M18x1
204-4007	Through Beam (Emitter)	Brass Nickel Plated	20000	2m Cable	-	M30x1.5
204-4009	Through Beam (Receiver)	Brass Nickel Plated	20000	2m Cable	PNP NO/NC	M30x1.5
204-4010	Through Beam (Emitter)	PBT	20000	2m Cable	-	M30x1.5
204-4011	Through Beam (Receiver)	PBT	20000	2m Cable	NPN NO/NC	M30x1.5
204-4012	Through Beam (Receiver)	PBT	20000	2m Cable	PNP NO/NC	M30x1.5

Diffuse Reflection with Background Suppression

- Many diffuse reflection sensors come with background suppression that prevents faulty triggering caused by reflections in the environment.



IP67 RATED

Stock No.	Detection Range (mm)	Output Type	Terminal Type
202-4470	100	PNP NO/NC	2m Cable
202-4471	100	PNP NO/NC	M12
202-4448	350	NPN NO/NC	2m Cable
202-4449	350	NPN NO/NC	M8
202-4450	350	PNP NO/NC	2m Cable
202-4451	350	PNP NO/NC	M8

Diffuse Reflection

- Universal housing, an ideal replacement for a wide range of sensor types
- IP67, suitable for harsh environments
- One-click distance setting, accurate and fast
- Suitable for the detection of high light objects and some transparent objects
- NO and NC are switchable
- Electrical Connection: PVC cable or M8 Connector



IP67 RATED

Stock No.	Detection Range (mm)	Terminal Type	Output Type	Thread Size
202-4428	100	2m Cable	NPN	-
202-4429	100	M8	NPN	-
202-4431	100	2m Cable	PNP	-
202-4432	100	M8	PNP	-
202-4433	300	2m Cable	NPN NO/NC	-
202-4434	300	M8	NPN NO/NC	-
202-4435	300	2m Cable	PNP NO/NC	-
202-4436	300	M8	PNP NO/NC	-
202-4453	300	2m Cable	NPN NO/NC	M18x1
202-4454	300	M12	NPN NO/NC	M18x1
202-4455	300	2m Cable	PNP NO/NC	M18x1
202-4456	300	M12	PNP NO/NC	M18x1
202-4476	300	2m Cable	Relay NO/NC	-
202-4424	1000	2m Cable	NPN	-
202-4425	1000	M8	NPN	-
202-4426	1000	2m Cable	PNP	-
202-4427	1000	M8	PNP	-
202-4472	2000	2m Cable	PNP+NPN	-
202-4473	2000	M12	PNP+NPN	-
202-4475	2000	2m Cable	Relay NO/NC	-

Diffuse Reflection with Terminal Chamber

- Diffused detection sensor for enhanced reliability and precision
- Reliably detect multiple colours and objects with accuracy
- Robust, all in one design with emitter and receiver built into single housing for easy installation in a wide range of environments
- Anti-interference offering excellent performance



IP67 RATED

Stock No.	Detection Type	Detection Range (mm)	Output Type
202-5452	Diffuse	800	Relay
202-5448	Diffuse	2000	NO+NC, NPN
202-5450	Diffuse	2000	NO+NC, PNP
202-5451	Diffuse	2000	Relay

Through Beam with Terminal Chamber

- Through beam detection sensor ideal for detecting objects at a distance
- Long sensing distance of 30m
- Relay output
- Infrared LED (880nm) light source
- Terminal connections
- High detection accuracy
- Special on-delay and off-delay function
- IP67 protection offering protection against dust and moisture build up
- Robust design ideal for use in a wide range of environments
- Anti-interference offering excellent performance



IP67 RATED

Stock No.	Detection Type	Detection Range (mm)	Output Type
202-5462	Through Beam (Receiver)	30000	Relay
202-5460	Through Beam (Emitter)	30000	Relay

Retro Reflection with Polarisation Filter

- Polarized reflection sensor for enhanced reliability and precision
- Red light light source
- NO/NC Output is switchable
- Reliably detect high light options and even some transparent objects with accuracy
- Anti-sunlight interference offering excellent performance



IP67 RATED

Stock No.	Detection Range (mm)	Terminal Type	Output Type
201-8160	3000	2m Cable	NPN NO/NC
201-8161	3000	M8	NPN NO/NC
201-8162	3000	2m Cable	PNP NO/NC
201-8163	3000	M8	PNP NO/NC

Through Beam

- Economical and reliable compact devices essential for industrial environments such as conveyor belts in manufacturing plants.



**IP67
RATED**

Stock No.	Detection Type	Detection Range (mm)	Terminal Type	Output Type
202-4442	Through Beam (Receiver)	10000	M8	NPN NO/NC
202-4443	Through Beam (Receiver)	10000	2m Cable	PNP NO/NC
202-4444	Through Beam (Receiver)	10000	M8	PNP NO/NC
202-4445	Through Beam (Emitter)	10000	2m Cable	-
202-4447	Through Beam (Emitter)	10000	M8	-
202-4461	Through Beam (Emitter)	20000	2m Cable	-
202-4463	Through Beam (Receiver)	20000	2m Cable	NPN NO/NC
202-4465	Through Beam (Receiver)	20000	2m Cable	PNP NO/NC
202-4462	Through Beam (Emitter)	20000	M12	-
202-4464	Through Beam (Receiver)	20000	M12	NPN NO/NC
202-4466	Through Beam (Receiver)	20000	M12	PNP NO/NC
202-4482	Through Beam (Emitter)	60000	2m Cable	-
202-4483	Through Beam (Receiver)	60000	2m Cable	Relay NO/NC

Retro Reflection with Polarisation Filter

- Suitable for the detection of high light objects and some transparent objects
- Electrical Connection: 2 m PVC cable or M12 Connector
- 360° LED status indicator
- Visible light spot for easy installation
- One-click distance setting, accurate and fast



**IP67
RATED**

Retro Reflection

- Retroreflective detection sensor ideal for detecting transparent objects
- All in one design with emitter and receiver built into single housing for easy installation
- Wide sensing distance of 5m to detect objects at a distance

**IP67
RATED**

Stock No.	Detection Type	Detection Range (mm)	Terminal Type	Output Type
202-4458	Polarised Reflection	3000	M12	NPN NO/NC
202-4459	Polarised Reflection	3000	2m Cable	PNP NO/NC
202-4460	Polarised Reflection	3000	M12	PNP NO/NC
202-4437	Polarised Reflection	4000	M8	NPN NO/NC
202-4438	Polarised Reflection	4000	2m Cable	NPN NO/NC
202-4439	Polarised Reflection	4000	2m Cable	PNP NO/NC
202-4478	Polarised Reflection	5000	M12	PNP+NPN
202-4481	Polarised Reflection	5000	M12	Relay NO/NC
202-5457	Polarised Reflection	12000	Terminal	NPN NO/NC
202-5458	Polarised Reflection	12000	Terminal	PNP NO/NC
202-5459	Polarised Reflection	12000	Terminal	Relay NO/NC
202-4440	Polarised Reflection	4000	M8	PNP NO/NC
202-4477	Polarised Reflection	5000	2m Cable	PNP+NPN
202-4479	Polarised Reflection	5000	2m Cable	Relay NO/NC



Stock No.	Detection Type	Detection Range (mm)	Output Type
202-5454	Retro-reflection	5000	NC, PNP
202-5456	Retro-reflection	5000	Relay
202-5453	Retro-reflection	5000	NC, NPN

PROXIMITY CAPACITIVE SENSORS

Capacitive proximity sensors feature a pair of parallel plates, similar to a standard capacitor. They work when an object produces changes in capacitance, triggering the sensor. Capacitive sensors are designed for use with non-ferrous materials and are ideal for close-range applications such as level detection and monitoring.

Capacitive sensors can be affected by their environment and possible interaction with other sensors. This could include anything from the ambient temperature to other objects in the vicinity. As a result of this, precautions should be taken when installing these sensors to avoid interference from other objects or sensors.

APPLICATIONS

Applications including flow control for detection of liquids, grains and powders. Common applications include the food and beverage industry, robotics, machine tools, packaging and materials handling.

MAIN ADVANTAGES

Proximity capacitive sensor can detect both metal and non-metal materials, especially suitable for detecting materials such as plastics, tank liquid level detection, hopper powders and particles. Ideal for sight glass monitoring.

Pipeline Mount

- This capacitive sensor can detect both metal and non-metal objects
- It also has the ability to detect various media via non-metallic containers
- They provide reliable and accurate liquid level detection
- Provides a lower-cost solution for proximity sensor needs whilst featuring good resolution, stability, high speed and low power usage



Stock No.	Pipe	OD / Wall Thickness	Terminal Type	Output Type
184-5575	Non Metal	12-26mm / <1mm	2m Cable	NPN-NO
184-5576	Non Metal	12-26mm / <1mm	2m Cable	PNP-NO
184-5572	Non Metal	8-11mm / ≤1mm	2m Cable	NPN-NO
184-5574	Non Metal	8-11mm / ≤1mm	2m Cable	PNP-NO

Flush Mount Proximity Capacitive Sensors

- Can detect both metal and non-metal objects
- Has the ability to detect various media via non-metallic containers

**IP67
RATED**



Image for illustrative purposes only

Stock No.	Housing Style	Detection Range (mm)	Terminal Type	Output Type
184-5578	M12x1	2	2m Cable	NPN-NO
184-5582	M12x1	2	2m Cable	NPN-NO
184-5584	M12x1	2	2m Cable	PNP-NO
184-5579	M12x1	2	M12	NPN-NO
184-5583	M12x1	2	M12	NPN-NO
184-5585	M12x1	2	M12	PNP-NO
184-5569	-	5	2m Cable	NPN-NO
184-5570	-	5	2m Cable	PNP-NO
184-5593	M18x1	5	2m Cable	NPN-NO/NC
184-5604	M18x1	5	2m Cable	NPN-NO/NC
184-5596	M18x1	5	2m Cable	PNP-NO/NC
184-5606	M18x1	5	2m Cable	PNP-NO/NC
184-5591	M18x1	5	2m Cable	NO
184-5594	M18x1	5	M12	NPN-NO/NC
184-5605	M18x1	5	M12	NPN-NO/NC
184-5607	M18x1	5	M12	PNP-NO/NC
184-5592	M18x1	5	M12	NO
184-5603	M18x1	5	M12	NO
184-5615	M30x1,5	10	2m Cable	NPN-NO/NC
184-5617	M30x1,5	10	2m Cable	PNP-NO/NC
184-5632	M30x1,5	10	2m Cable	PNP-NO/NC
184-5613	M30x1,5	10	2m Cable	NO
184-5627	M30x1,5	10	2m Cable	NO
184-5634	M30x1,5	10	2m Cable	NO
184-5616	M30x1,5	10	M12	NPN-NO/NC
184-5631	M30x1,5	10	M12	NPN-NO/NC
184-5633	M30x1,5	10	M12	PNP-NO
184-5619	M30x1,5	10	M12	PNP-NO/NC
184-5614	M30x1,5	10	M12	NO
184-5628	M30x1,5	10	M12	NO
184-5635	M30x1,5	10	M12	NO
184-5629	M30x1,5	15	2m Cable	NPN-NO/NC

Non-flush Mount Proximity Capacitive Sensors

- This capacitive sensor can detect both metal and non-metal objects
- It also has the ability to detect various media via non-metallic containers
- They provide reliable and accurate liquid level detection
- Provides a lower-cost solution for proximity sensor needs whilst featuring good resolution, stability, high speed and low power usage
- Each sensor has a simple in construction and is adjustable
- They can be used for the measurement of force, pressure and humidity, etc. and they have a higher sensitivity and can be operational with small magnitude of force
- Capacitive proximity sensing offers increased usability, improved industrial design, and increased functionality with many different consumer applications

**IP67
RATED**



Image for illustrative purposes only

Stock No.	Housing Style	Detection Range (mm)	Terminal Type	Output Type
184-5580	M12x1	4	2m Cable	NPN-NO
184-5586	M12x1	4	2m Cable	NPN-NO
184-5588	M12x1	4	2m Cable	PNP-NO
184-5581	M12x1	4	M12	NPN-NO
184-5587	M12x1	4	M12	NPN-NO
184-5590	M12x1	4	M12	PNP-NO
184-5571	-	8	M12	NPN-NO
184-5599	M18x1	8	2m Cable	NPN-NO/NC
184-5609	M18x1	8	2m Cable	NPN-NO/NC
184-5611	M18x1	8	2m Cable	PNP-NO/NC
184-5597	M18x1	8	2m Cable	NO
184-5600	M18x1	8	M12	NPN-NO/NC
184-5610	M18x1	8	M12	NPN-NO/NC
184-5601	M18x1	8	M12	PNP-NO/NC
184-5612	M18x1	8	M12	PNP-NO/NC
184-5598	M18x1	8	M12	NO
184-5608	M18x1	8	M12	NO
184-5577	-	10	2m Cable	NPN-NO
184-5622	M30x1,5	15	2m Cable	NPN-NO/NC
184-5638	M30x1,5	15	2m Cable	NPN-NO/NC
184-5625	M30x1,5	15	2m Cable	PNP-NO/NC
184-5640	M30x1,5	15	2m Cable	PNP-NO/NC
184-5620	M30x1,5	15	2m Cable	NO
184-5636	M30x1,5	15	2m Cable	NO
184-5623	M30x1,5	15	M12	NPN-NO/NC
184-5639	M30x1,5	15	M12	NPN-NO/NC
184-5626	M30x1,5	15	M12	PNP-NO/NC
184-5641	M30x1,5	15	M12	PNP-NO/NC
184-5621	M30x1,5	15	M12	NO
184-5637	M30x1,5	15	M12	NO
184-5642	M30x1,5	15	M12	NO

Open End Sensor Cables

- Introducing the range of RS PRO Cables, ideal for use with industrial sensor and automation equipment.
- This cable has been designed with a secure coupling nut and a partially stripped free end connection on the other side, allowing complete flexibility for connection.
- The 20 m PUR multi-strand cable is ultra-durable, protecting the internal wires, and easy to install, making it an ideal solution where secure and reliable data transference is required.



Stock No.	Body Orientation	Connection A		Connection B		Cable Length
		Gender	Connection Size	Gender	Connection Size	
205-5980	Angled	Female	M12	-	Open End	15m
205-5993	Angled	Female	M12	-	Open End	20m
205-5992	Straight	Female	M12	-	Open End	10m
205-5987	Straight	Male	M8	-	Open End	10m

Panel Mount Sensor Cables

- Ideal for panel mounting in production and manufacturing environments.
- The partially stripped free end connections allow complete flexibility for connection.



Stock No.	Type	Gender	Connection Size	No of contacts
205-5976	Circular Connector	Female	M12	4
205-5974	Circular Connector	Female	M12	5
205-5982	Circular Connector	Male	M12	4
205-5991	Circular Connector	Male	M12	4
205-5978	Circular Connector	Male	M12	5

Adjustable Mounting Brackets

- Zinc Plated Steel Bar and Nylon Clamping Parts



Stock No.	Type	Suitable for Sensors
256-001	Panel Mount	M4, M5, M8, M12, M14, M18
256-017	Panel Mount	M30
714-1697	Rail Mount (Ø 8 or 12mm)	M4, M5, M8, M12, M14, M18

Sensor Mounting Brackets

- Material: Steel, zinc coated
- Multiple mounting options
- Right-angled
- Fast installation
- M8 to M30 fittings
- Compatible with Inductive Proximity Sensor



Stock No.	Dimensions	Suitable for Sensors
213-3660	30 x 30 x 26.5mm	M12
213-3661	30 x 30 x 26.5mm	M8
213-3662	60 x 42 x 55mm	M30
213-3659	42 x 37 x 36.5mm	M18

TOOLS & CONSUMABLES

The RS PRO range includes tough, industrial grade tools, kits and cabinets - all the tools an electrical engineer or maintainer may need.

Stainless Steel Screw/ Bolt, Nut & Washer Kit

- This RS A2 Stainless Steel Torx Kit contains 2,375 A2 stainless steel security torx head screws in a range of metric thread sizes from M3 through to M6 size.



819-9004 2475 pieces

LED Head Torch

- With 6 light settings, in a water and impact resistant case
- Uses 3xAAA batteries (included)



200-6746 350lm

UV LED Torch

- Flood to spot beam twist zoom
- 1m impact-resistant
- IPX4 water-resistant

**IPX4
RATED**



220-6819 Red 2.7 lm, 147 mm

LED Torch

- The anti-roll body ensures that Torch securely stays in 1 position rather than rolling off the surface.
- Twist flood to spot beam control, that allows users to either create a long-range light or a more focused circular beam of light or create a wide pattern of light.
- A tactical rubberised switch
- The nylon wrist strap prevents the user from accidentally dropping the torch.



176-6034 1400 lumen

Aluminium LED Torch

- Long life LED lamp
- Luminosity of 600 lm
- Easy to adjust beam
- 3 beam settings - high, low and strobe
- Not rechargeable
- Four AAA batteries included



196-4195 250 lm, 150 mm

196-4196 600 lm, 163 mm

LED Pen Torch

- Compact penlight torch uses an extra strong CREE XPG LED to offer a bright light with an easy twist flood-to-spot feature for closer lighting inspection
- IP56 water resistant and up to 1 m impact resistant, making it suitable for harsh environments like worksites



200-6747 180 lm, 150 mm

YOUR SMART CHOICE FOR FACILITIES MAINTENANCE

We provide everything you need to keep your facilities safe and secure and to protect people at work. And then brooms, mops, buckets, vacuum cleaners, soap dispensers, sanitiser stations, paper towels, hand dryers and high-quality smart temperature monitors for access control - both to buildings and open environments. And let's not forget hygiene and cleaning, an important part of safety!



Visit rspro.com to browse our Facilities Maintenance Range Guide



**Electrician's Tool Kit
32 Piece**

- Ergonomic multi-component handles
- Optimum balance of torque and control
- High quality
- VDE approved for electrical safety
- Tool storage - comes in a sturdy tool bag



136-3411 32 Piece Electricians Tool Kit with Case

Kit contains

- | | |
|---|--|
| <ul style="list-style-type: none"> 01 Wallboard Saw - 160 mm 02 Safety Goggles 03 Compact Tape Measure - 3x16 mm / 10 ft 04 Claw Hammer - 16 oz. 05 Flat Cold Chisel - 16x150/20x175mm 06 Hacksaw (in-Handle Fixing System) 07 Mini Hacksaw 08 Automatic Wire Stripper 09 Trimming Knife 10 Professional LED Flashlight 11 Marker Pen 12 Single-Pole Voltage Tester (Short) 13 Electronics Slotted Screwdriver - 3x80 mm | <ul style="list-style-type: none"> 14 Slotted Screwdriver (Flared Tip) - 10.0x200 mm 15 150 mm Screw Gripping Screwdriver 16 Stubby Slotted Screwdriver - 5.5x25 mm 17 Stubby Pozidriv Screwdriver - PZ2x25 mm 18 Insulated Pozidriv Screwdriver (VDE) - PZ1x80/PZ2x100 mm 19 Insulated Slotted Screwdriver (VDE) - 2.5x 75 / 4.0x100 mm 20 Long Nose Pliers - 160 mm 21 Diagonal Cutter - 160 mm 22 Combination Pliers - 200 mm 23 RZR Series Cable Shears - 170 mm 24 Multi-Purpose Cutter (Straight) 25 Adjustable Wrench (Phosphate/PVC) - 200 mm 26 Water Pump Pliers (Box Joint/PVC) - 250 mm Water Pump Pliers (Box Joint/PVC) - 300 mm |
|---|--|

VDE Tool Kit

- Designed for professional engineers who work on or around electrically live circuits
- All tools are VDE certified and individually tested for use up to 100V AC



829-6549 24-piece

**Electricians Tool Kit
36 Piece**

- Ergonomic multi-component handles
- Optimum balance of torque and control
- High quality
- VDE approved screwdrivers and pliers for electrical safety
- Tool storage - comes in a sturdy tool case

**VDE
APPROVED**



136-3417 36 Piece Electricians Tool Kit with Case

Kit contains:

- 01 Claw Hammer - 16 oz.
- 02 Mini Hacksaw
- 03 Compact Tape Measure - 3x16 mm / 10 ft
- 04 Torpedo Level
- 05 Ratchet Bit Driver Set
- 06 Rethreading Tool - M3.5
- 07 Single-Pole Voltage Tester (Short)
- 08 Non-Contact
- 09 Insulated Pozidriv Screwdriver (VDE) - PZ1x80 / PZ2x100 / Flat-Pozi 2x100mm
- 10 Insulated C-PLUS Phillips Screwdriver (VDE) - PH1x80/PH2x100 mm
- 11 Insulated C-PLUS Slotted Screwdriver (VDE) - 3.0x100/4.0x100/ 5.5x125/6.5x150 mm
- 12 Automatic Wire Stripper
- 13 Cable Stripper
- 14 Electrician Knife (1000V)
- 15 Insulated Combination Pliers (VDE) - 180 mm
- 16 Insulated Diagonal Cutter (VDE) - 160 mm
- 17 Insulated Long Nose Pliers (VDE) - 200 mm
- 18 RZR Series Insulated Cable Shears (VDE) - 170 mm
- 19 Insulated Water Pump Pliers (VDE) - 250 mm

125-3049 20 Tool Case, 530 x 180 x 400mm

Electrician's Tool Kit

- Ergonomic multi-component handles
- Optimum balance of torque and control
- Ideal for fine and delicate work
- High-quality multi-tools and accessories
- Range of labels



136-3402 29 Piece Electricians Tool Kit with Case

Kit contains:

- | | |
|--|---|
| <ul style="list-style-type: none"> 01 Electrician Knife (1000V) 02 RZR Series Insulated Cable Shears (VDE) - 170 mm 03 Insulated Wire Stripping Pliers (VDE) - 160 mm 04 Insulated Diagonal Cutter (VDE) - 160 mm 05 Insulated Combination Pliers (VDE) - 180 mm 06 Insulated Long Nose Pliers (VDE) - 200 mm 07 Insulated Open End Wrench (1000V) - 5.5/6/7/8/10/12/13/17/19 mm 08 Safety Goggles 09 Black/Yellow insulation tape 10 "Unsafe" Label 11 Junior Hacksaw (1000V) 12 Insulated Water Pump Pliers (VDE) - 250 mm | <ul style="list-style-type: none"> 13 Insulated Pozidriv Screwdriver (VDE) - PZ0x60/PZ1x80/PZ2x100/PZ3x150mm 14 Insulated Slotted Screwdrivers (VDE) - 2.5x75/4.0x100/5.5x125/6.5x150 /8.0x175mm 15 "Danger" Label 16 "H.V. Test Area" Label 17 "Electric Shock" Label 18 "Live Wires" Label 19 "High Voltage" Label 20 "Disconnect" Label 21 "415 V a.c." Label 22 "240 V a.c." Label 23 "115 V a.c." Label |
|--|---|

125-3049 Tool Case, 530 x 180 x 400mm

Electricians Tool Kit

- An extensive VDE approved tool kit designed for professionals who work on or around electrically live circuits.
- Ergonomic multi-component handles
- Constructed from Chrome Vanadium Steel
- Versatile and durable carry case complete with cut-out slots for each individual component.



734-8885 88 Piece Electricians Tool Kit with Case

Kit contains:

- | | |
|--|---|
| <ul style="list-style-type: none"> 1/2 Inch Sockets (14 - 32mm) 1/2 Inch Extension (125 & 250mm) 1/2 Inch Plug Wrench (16 & 21mm) 1/4in Sockets (4 - 13mm) 1/4in Extension (55 & 100mm) 1/4in Connector 1/2 Inch & 1/4in Reversible Ratchet 1/2 Inch & 1/4in Universal Joint 1/2 Inch & 1/4in Sliding T bar Metric Wrench (8 - 17mm) | <ul style="list-style-type: none"> 6in Insulated Slip joint pliers 6in Insulated Nipper pliers 6in insulated Wire strippers, 7in Insulated Wire cutters Insulated Water pump pliers Electricians Shears 250V Test pencil 300g Hammer 5m Tape measure Driver bits (x20) Insulated Screwdrivers (x5) Hex Keys (x9) |
|--|---|

VDE Approved Tools

The best electrician's tools are fully insulated against electrical shocks: an obvious safety hazard. Look for those with accreditation from the Verband der Elektrotechnik, Elektronik und Informationstechnik (VDE) – the German Association of Electrical Engineering, Electronics and Information Technology, which provides an internationally recognised standard for electrical safety.

VDE approval ensures that tools like screwdrivers are safe to use when working with electricity. A VDE approved tool means that it has passed a series of rigorous tests ensuring the quality, safety and construction.



Insulated Screwdriver and Pliers Set

- A 5 piece electricians' hand tool kit which includes the most essential tools to perform a variety of repair and maintenance tasks within an electrical environment
- Made from Chrome Vanadium Steel for increased durability and strength, allowing for longer-lasting tool life
- DuoTech soft-grip plier handles for optimum comfort and grip, even when working for long periods of time
- Each screwdriver has been designed with the ergonomic C-PLUS soft-grip handles, allowing for even transfer of force and increased comfort when applying large amounts of force for stubborn fasteners



VDE APPROVED

125-3096 5 Piece Set - 1 x Insulated Combination Pliers (G10 Series), 1 x Insulated Diagonal Cutter (G12 Series), 2 x C-PLUS Insulated Slotted Screwdrivers (G01 Series), 1 x C-PLUS Insulated Pozidriv Screwdrivers (G03 Series)

Insulated Electrician's Knife

- 1000V approved cable knife, ideal for use on or around energised systems
- Sickle shaped strong and durable stainless-steel blade for long lasting blade life and can easily and efficiently cut the cable sheath without the risk of damaging the cable
- Blade guard on handle to avoid slippage injuries
- Lanyard hole for working at height



829-6518 44mm Blade

VDE APPROVED

Insulated Plier Set with Foam Module

- 3 Piece VDE Plier Quality Set is for working on 1000V AC or 1500V DC
- DuoTech Soft grip handles allow for easy and smooth action
- Smooth Operating Action reduces the fatigue of the user
- Supplied with Foam Module ensures the tools are kept tidy

VDE APPROVED



833-5931 3 Piece Set, 180mm Combination Pliers (G10), 160mm Diagonal Cutters (G12), 160mm Long Nose Pliers (G15)

Plier Sets

- Special tool steel Polished finish (electofilmed)
- DuoTech soft grip handles
- G10 - ISO 5745
- G12 - ISO 5749

VDE APPROVED



125-3094 2 Piece Set - Insulated Combination Pliers (G10 Series) & Insulated Diagonal Cutter (G12 Series)

Plier Sets

- Special tool steel
- Chrome finish
- DuoTech soft grip handles

VDE APPROVED



125-3095 3 Piece Set - Diagonal cutter, long nose plier & combination plier

Insulated Water Pump Pliers

- Ideal for live working up to 1000Vac or 1500Vdc
- 9 position adjustment
- Chrome Vanadium steel
- Phosphate finish
- Soft-grip handles

VDE APPROVED



125-3076 Multigrip Slip Joint, 250mm

Insulated Combination Pliers

- Special tool steel and chrome finish
- DuoTech soft grip handles
- VDE Approved, ISO 5745

VDE APPROVED



125-3065 G10 Series, Combination, 160mm

125-3066 G10 Series, Combination, 180mm

125-3067 G10 Series, Combination, 200mm

Insulated Long Nose Pliers

- Chrome finish
- DuoTech soft grip handles
- ISO 5745
- G15 Series

VDE APPROVED



125-3072 G15 Series, Long nose, 160mm

125-3073 G15 Series, Long nose, 200mm

Diagonal Cutters

- Special tool steel; Chrome finish
- DuoTech soft grip handles
- ISO 5749, G12 Series

VDE APPROVED



125-3070 G12 Series, 180 mm

125-3068 G12 Series, 140 mm

125-3069 G12 Series, 160 mm

Angled Long Nose Insulated Pliers

- Special tool steel
- Chrome finish
- DuoTech soft grip handles
- VDE Approved, ISO 5745

VDE APPROVED



125-3074 G16 Series, Bent nose, 200mm

Insulated Pliers

- 45° angled blades
- Ergonomic handles
- Ideal for precision work with soft wire

VDE APPROVED



847-3800 Long nose

Insulated Non-Impact Sockets

- Bi-Hex (12 point) Socket Heads
- Each tool is injection moulded
- Nylon 11 insulation
- 1/2 Inch Square drive
- 8mm to 32mm sizes available
- IEC60900, Category 'C', 1000v

**IEC
60900:2004**



- 911-1402 8mm
- 911-1409 10mm
- 911-1411 12mm
- 911-1415 13mm
- 911-1424 14mm
- 911-1421 16mm
- 911-1430 17mm
- 911-1433 18mm
- 911-1437 19mm
- 911-1446 20mm
- 911-1443 22mm
- 911-1455 24mm
- 911-1459 25mm
- 911-1461 27mm

Insulated Ratcheting Ring Spanners

- The 72-tooth ratchet ring and gear produce a 5° rotation allowing it to function in tight spaces.
- Each tool is injection moulded
- Nylon 11 insulation
- IEC 60900:2004 specification

**IEC
60900:2004**



- 911-1308 10mm
- 911-1310 13mm
- 911-1326 17mm

Insulated Reversible Ratchet Spanners

- Each tool is injection moulded
- Reversible for added flexibility
- Nylon 11 insulation
- IEC 60900:2004 specification

**IEC
60900:2004**



- 911-1487 13x17mm
- 911-1496 17x19mm

Insulated Ring Spanners

- Single Ended with 60° Offset Head
- Each tool is injection moulded with Nylon 11 insulation
- IEC 60900:2004 specification
- Heavy-duty spanners for use in any application

**IEC
60900:2004**



- 911-1288 10mm
- 911-1281 13mm
- 911-1285 17mm
- 911-1294 19mm

Insulated Open Ended Spanners

- Each tool is injection moulded
- Nylon 11 insulation
- IEC 60900:2004 specification
- Warning thumb stop

**IEC
60900:2004**



- 911-1187 10mm
- 911-1193 13mm
- 911-1203 17mm

Insulated Torque Wrenches

- Each tool is injection moulded with Nylon 11 insulation
- IEC 60900:2004 specification
- Easy to read Window scale
- Reversible action

**IEC
60900:2004**



- 911-1531 1/2"
- 911-1522 3/8"

Hexagon Nut Driver Set

- Made from chrome vanadium molybdenum steel blade material
- Hexagon tip type
- VDE/1000 V approved

**VDE
APPROVED**



- 182-9772 Set of 5 - Tip size of 6 mm, 7 mm, 8 mm, 10 mm, 13 mm

Insulated Nut Spinners

- 150mm stud clearance
- Each tool is injection moulded
- Nylon 11 insulation
- IEC 60900:2004 specification
- Available in various metric and BA sizes

**IEC
60900:2004**



- 911-1503 0BA
- 911-1506 1BA
- 911-1500 2BA
- 911-1519 3BA
- 911-1512 4BA
- 911-1525 8mm
- 911-1528 10mm

Insulated Screwdrivers

- For live working up to 1000 V ac or 1500 V dc
- Chrome Vanadium Molybdenum steel blade (phosphate finish)
- C-PLUS soft-grip handle
- Individually tested as per DIN EN 60900: 2004 norm

VDE APPROVED



125-3078	2.5x75mm
125-3079	3x100mm
125-3080	3.5x100mm
125-3081	4x100mm
125-3082	5.5x125mm
125-3083	6.5x150mm
125-3084	Ph1x80mm
125-3085	Ph2x100mm
125-3086	Pz1x80mm
125-3087	Pz2x100mm
125-3088	MOD1x80mm
125-3089	MOD2x80mm

Screwdriver Set with Voltage Tester

- Slotted and Pozidrive screwdrivers
- VDE approved tools for working in rigorous health and safety standards
- Voltage tester included
- Ergonomic soft grip handles

VDE APPROVED



875-5812 4 x Slotted Screwdrivers (3 mm, 4 mm, 5.5 mm, 6.5 mm), 2 x Philips Screwdriver (PH1, PH2), 1 x Voltage Tester

Insulated Screwdriver Set

- 10-Piece 1000V insulated screwdriver set manufactured with durable chrome-molybdenum vanadium steel and easy grip handles

VDE APPROVED



253-015 Slotted (2.5; 3; 4; 5.5; 6.5mm), Phillips (PH0; PH1 PH2), Pozidriv (PZ0; PZ1)

4 Piece Slotted Insulated Screwdriver Set

- 1000Vac and 1500Vdc voltage isolation
- DuoTech ergonomic handle
- Tested according to DIN EN 60900: 2004
- For full set contents visit our website

VDE APPROVED



125-3092 3 x slotted, 1 x Philips

125-3093 3 x slotted, 1 x Pozi

Screwdriver Set with Voltage Tester

- Slotted and Pozidrive screwdrivers
- VDE approved tools for working in rigorous health and safety standards
- Voltage tester included
- Ergonomic soft grip handles

VDE APPROVED



875-5821 4 x Slotted Screwdrivers (3 mm, 4 mm, 5.5 mm, 6.5 mm), 2 x Pozi Screwdrivers (PZ1, PZ2), 1 x Voltage Tester

300mm Circlip Plier Set

- 4 Piece Circlip Plier Quality Set for inserting and removing circlips
- Ergonomic Red PVC grip handles allow for easy and smooth action
- External Pliers have a sprung design to help handles open
- Supplied with a Foam Tool Module to ensure the tools are kept tidy
- Made from Chrome Vanadium Steel



833-5929 External Circlip Pliers (Straight with Spring), External Circlip Pliers (Bent with Spring), Internal Circlip Pliers (Straight), Internal Circlip Pliers (Bent)

Din Standard Circlip Pliers

- Fitted with red PVC vinyl dipped covered handles
- External types incorporate return springs
- Black oxidised finish



541-6781 Internal bent 3-10mm

541-6826 External straight 3-10mm

541-6753 Internal straight 3-10mm

541-6769 Internal straight 8-25mm

Interchangeable Multi-Position Circlip Pliers

- Cushion-grip handles and spring loaded for faster comfortable operation



541-7267 External 6.4-25.4mm

182-436 External/internal 6.4-48mm/6.4-25.4mm

Locking Pliers Set

- Locking pliers maintain constant gripping force
- The guarded release lever is an important safety feature
- Supplied in a plastic tool roll pouch
- Ease of storage and transportation



847-3762 Chrome Molybdeum Steel, 180mm, 3 Pieces - 10" & 7" Locking Pliers with built-in wire cutter, 6" Long Nosed Pliers

847-3768 Chrome Vanadium Steel, 250mm, 3 Pieces - 10" & 7" Locking Pliers with built-in wire cutter, 6" Long Nosed Pliers

3 Piece Plier Set, 250 Mm Overall

- 3 Piece Plier Quality Set with Polished Finish
- Ergonomic Soft grip handles allow for easy and smooth action
- Smooth Operating Action reduces the fatigue of the user
- Serrated Jaws for an excellent prolonged grip
- Supplied with Foam Module ensuring the tools are kept tidy



833-5972 3 Pieces - 180 mm Combination Pliers, 160 mm Diagonal Side Cutters & 160 mm Long Nose Pliers

Electronic Pliers

- Strong and Hardwearing body
- Specially designed ergonomic handles



847-3780 Slim Side cutters, 4.5 inch, Cutting capacity soft wire: <0.8mm

847-3784 Side cutters, 4.5 inch, Cutting capacity soft wire: <1.3mm

847-3816 End nipper

Combination Pliers

- Optimum cutting edge geometry
- Precision milled
- Heat treatment to exacting standards
- Redesigned DuoTech grips



875-5767 140mm

487-230 150mm

875-5761 160mm

875-5770 180mm

875-5773 200mm

875-5802 200mm

Diagonal Cutters

- Duo Tech soft grip handles
- Polished finish (Electrofilmed)
- DIN/ISO 5749, TS 11071



875-5792 140mm

875-5795 160mm

875-5799 180mm

875-5806 Power 180mm

Engineers Pliers

- Induction hardened with a natural finish to ensure a long, reliable working life
- Ergonomically designed bow handles with PVC grip provide maximum leverage and comfort



541-7093 Radio 140mm

541-7071 Snipe nose 120mm

541-7043 Snipe nose 160mm

Electronic Pliers

- Strong and Hardwearing body
- Specially designed ergonomic handles



847-3756 Radio 140mm

847-3724 Radio 200mm

847-3752 Round nose 130mm

847-3737 Snipe nose 120mm

847-3737 Snipe nose 130mm

Impact Socket Sets

- Impact-rated 6-point chrome molybdenum sockets
- Storage case with labelled moulds for each size
- Exceed ANSI specifications, with two grease rings for grip
- Centre hole punched for extra depth, Z-Drive for strong grip
- Thin wall design with chamfered openings



137-0909 18 Piece Impact Socket Set, 1/2" Metric, 10 > 32mm

137-0908 8 Piece Air Impact Socket Set, 1/2" Metric, 12 > 24mm

66 Pieces 1/4 Inch And 1/2 Inch Socket Set

- Chrome Vanadium for excellent strength and corrosion resistance
- Soft comfortable ratchet handles for reduced fatigue and a tighter grip
- Fitted case reduces lost parts
- Bit sizes marked directly on the holders for quick identification of missing bits
- Strong latches for secure closing
- 75 mm and 250 mm extension bar for hard to reach areas



817-9249 66 Piece Metric 1/2 in; 1/4" Standard Socket/Bit Set with Ratchet

Socket Bit Set

- 45 Piece hexagon, spline & TX bits with adaptors in a handy storage case



213-1011 45 Piece Metric 1/2 in; 3/8" Standard Socket/Bit Set

46 Pieces 1/4 inch and 3/8 inch Socket and Bit Set

- Chrome Vanadium for excellent strength and corrosion resistance
- Soft comfortable ratchet handles for reduced fatigue and a tighter grip
- Fitted case reduces lost parts
- Bit sizes marked directly on the holders for quick identification of missing bits
- 1/4 and 3/8 Inch drive options



817-9242 46 Piece Metric 1/4 in; 3/8" Standard Socket/Bit Set with Ratchet

61 Piece Socket Set, 1/2 In, 1/4 Inch, 3/8 Inch Square Drive

- Drive size of 1/2 in, 1/4 Inch and 3/8 in
- Square drive type
- Chrome finish
- Chrome vanadium steel material
- 61 Pieces



480-6880 Socket Sizes (4 > 14, 9 > 19, 9 > 24mm), Drive Sizes (1/2 in, 1/4", 3/8 in)

Universal Switch Key Wrench

- Compact, yet durable tool designed for use with a wide range of applications including locking systems and valves



- 439-3019** Chrome finish
- 439-3025** Zinc alloy finish

Penknife Hexagonal Sets

- Metric and imperial sets of hexagon keys which fold into a convenient penknife style handle
- Keys have blackened finish, steel handle is bright zinc-plated



- 451-8993** 7 Piece metric, 1.5mm, 2.0mm, 2.5 mm, 3 mm, 4 mm, 5 mm, 6 mm
- 314-2977** 7 Piece metric, 2.5 mm, 3 mm, 4 mm, 5 mm, 6 mm, 8 mm, 10mm
- 537-754** 9 Piece imperial long arm, 5/64 > 1/4in
- 451-9003** 9 Piece imperial short arm, 0.05 > 3/32in
- 537-760** 9 Piece metric, 1.5 > 8mm

Plastic Holder Sets

- Short arm L-shaped hexagon key sets in tempered chrome-vanadium steel, with chemically blackened finish
- Contains 10-pieces 1.5-10mm, supplied in plastic holder



- 537-748** 10 Piece L Shape Metric Hex Key Set, 1.5 > 10mm

52 Piece Metric 1/4 Inch Deep Socket/Standard Socket/Allen Key/Bit Set With Ratchet

- High-quality square 6-point metric socket set and hex keys
- Steel construction for strength and durability
- Bright red foam for quick part identification
- Comfortable reversible quick-release ratchet handle
- Long arm L-shaped key set in plastic caddy for easy storage
- Foam tool modules designed for easy removal from drawers



- 833-5935** 52 Piece 1/4" Drive Socket and Hex Key Set

Bit/Socket Set

- Hardened Chrome Molybdenum Steel bits
- Chrome Vanadium Steel nuts with zinc alloy
- Chrome-plated bit holder, sandblasted finish
- Innovative case for easy access and transport
- Kit includes various drivers, sockets, and screwdriver heads



- 213-1005** 30 Piece Set - Bit Holder (1), Bits (20), Screw Finders (2), Sockets (7)

High-Speed Steel (HSS) Step Drill Bits

- High quality
- Reduced vibration
- Faster drilling rate



HSS Step Drills, De-burring

- Multi-Dia. cutters requiring no pilot hole to cut stainless steel, carbon steel, soft metals and plastic
- 3-flute cutting action provides accurate parallel holes in sheet material up to 3mm thick
- 3mm increments



123-8510 9 Steps, 4 to 12 mm, 6.5 mm shank

123-8513 10 Steps, 4 to 22 mm step drill 10 mm shank

123-8508 10 Steps, 6 to 30.5 mm, 10 mm shank

123-8509 12 Steps, 6 to 30 mm, 10 mm shank

123-8515 12 to 25 mm Clearance & Tapping step drill

123-8511 13 Steps, 5 to 35 mm, 13 mm shank

123-8514 16 to 25 mm conduit entry step drill

123-8512 16 to 32 mm conduit entry step drill

232-529 8 to 41 mm Drill Bit, 11 Steps, 5 mm Max Drilling Thickness

232-507 6 to 36 mm Drill Bit, 11 Steps, 5 mm Max Drilling Thickness

232-513 7 to 37 mm Drill Bit, 11 Steps, 5 mm Max Drilling Thickness

Bi-metal hole saws

- Hardened cutting edge welded to a tough alloy steel body
- For use with ferrous and non ferrous metals, plastics and wood to a depth of 32mm
- 14-30mm dia saws require a 6.5mm arbour
- 32-152mm dia saws require a 9.5mm arbour



215-978 9.5mm Arbour

215-990 Pilot drill bit, 6.5 mm

Thinwall Hole Saw Kits

- Choice of Thinwall and TCT hole cutter kits
- Use on multiple materials - wood, thin sheet metal and plastic



918-6409 7-piece TCT

Carbide Hole Saw Set

- Tungsten Carbide tipped hole saws give you outstanding cutting performance and product durability
- For use on multiple materials including stainless steel, mild steel, copper and brass sheets



673-4718 20mm

673-4712 22mm

673-4724 32mm

Metric HSS Twist Drill Bits

- Perfect for general purpose workshop and maintenance drilling work
- High Speed Steel (HSS) construction, ideal for use with power tools
- Black finish for corrosion and wear protection



213-089 2.5mm

HSS Cobalt Jobber Drills

- Plan Shank
- Various lengths
- Cobalt (5%)
- HSS for performance and safety
- Perfect for general workshop and maintenance use



216-656 2.5mm

216-482 3.3mm

216-583 5.0mm

170-Piece HSS-TiN Coated Jobber Drill Set

- Large High Speed Steel Titanium coated drill set
- Contains multiples of some of the most popular sizes 1.0mm to 10mm drill bits in 0.5mm increments
- Ground flute
- Ideal for general workshop applications
- Manufactured to DIN338 standard
- Heavy duty steel case with moulded rigid insert for secure storage of drill bits



507-1732 170 PCS

Cobalt Jobber Drill Sets

- HSCo (5%) jobber drills for use on alloy steel, hardened steel, stainless steel, cast iron and titanium
- 135° split point



216-678 19-piece 1-10mm
216-690 25-piece 1-13mm

Jobber Drill Sets

- Ground flute High Speed Steel jobber drills
- Ideal for general workshop or maintenance use where high precision and productivity are not required
- Housed in a steel case



507-1704 19-Pieces 1-10mm
212-941 25-Piece 1-13mm

HSS TiN Coated Drill Bits

- Titanium Nitride Coated (TiN)
- Longer shaft length
- Right angle cutting tip
- 118° cutting angle
- Available in sizes from 0.25 – 20mm
- Suitable for metals, woods, plastics



213-411 3.0mm
213-304 3.5mm
213-922 2.5mm
213-203 5.0mm

Rolled Forged

- Rolled Flute; Copper Brazed Percussion Grade Carbide Tip
- Straight Shank



215-057 6mm Dia. x 400mm
215-192 10mm Dia. x 150mm LG

Micro HSS Drill Bit Set

- Versatile set with micro drill bits in a variety of sizes
- Perfect for use with a range of materials including plastic, wood, aluminium, glass fibre and more
- Ideal for producing clean and precise holes
- Supplied in a plastic storage case with sizes printed on to keep them organised



457-627 0.5 mm to 2.2 mm

HSS Jobber Drill Bit

- DIN338
- Fully Ground Drill
- 188o Point Angle



787-7330 0.40mm, 5 Pieces
787-7337 0.50mm, 5 Pieces
787-7349 0.60mm, 5 Pieces
787-7359 0.80mm, 5 Pieces

Compact Multimeters

- Manual ranging, 2000 count DMM that measures capacitance, voltage, current, resistance and temperature



1231939 RS12 Manual Ranging

Compact Multimeters

- 2000 Counts LCD backlit display
- Voltage 600V ac/dc
- Current 10Aac/dc
- Resistance
- Temperature measurement (RS14)
- Continuity
- EN61010-1 CAT III 600 V



1231938 RS14 Autoranging

Handheld Digital Multimeter

- Digital multimeter
- Compact and handheld
- Measures AC/DC Voltage, AC/DC current, Resistance, Diode test, Continuity, Capacitance Frequency and Temperature
- Non-Contact AC Voltage detector
- Long service life
- Battery type: 2 x AAA 1.5V



2647228 RS-927A, True RMS, 10A ac Max, 10A dc Max, 600V ac Max

Insulation & Continuity Testers

- Triple insulation voltage Test Ranges: 250V; 500V; 1000V (RS5505 adds 125V range)
- 200mA short current continuity range
- Test Hold function for easy operation
- Over range indication
- 1 mA test current for MΩ range at rated voltage
- Meets IEC 10101, CAT III 1000 V



123-1931 2GΩ CAT III 1000 V

Clamp Meter

- 400A AC auto-ranging clamp meter with AC and DC voltage, resistance, continuity functions
- Uses non-contact detection with Overvoltage Category III 600 V protection
- Supplied with test leads, carrying case, temperature probe, AAA 1.5 V batteries x2 and user manual



1231935 RS380, 400A ac CAT III 600 V

True RMS AC/DC Clamp Meter with Dual Type K Inputs

- Large, easy-to-read backlit LCD display for greater functionality, the clamp meter is also ideal for use in low light environments
- Comes with a 9 V battery, test leads and a temperature probe



2003702

Compact Digital Multimeter

- Compact design makes this multimeter ideal for working on the go
- Clear and precise 2000 count LCD display screen
- Safety category CAT III, CAT IV, 600 V, 1000 V
- Ideal for measurement of AC Current, AC Voltage, Continuity, DC Current, DC Voltage, Diode, Resistance
- Test leads included



1611625

3 in 1 Wall Scanner

- Detects metal or wooden studs from 0-38mm through drywall
- Live AC wires can be detected from 0-50mm through drywall
- Handheld and powered by a 9V battery
- Supplied with a 9V battery and gift box



193-8684 Stud, Metal and AC Voltage Finder

Earth & Ground Resistance Tester

- Meets IEC10101, CATIII 1000V
- Large dual display with back light & Low Battery Indication
- Test hold function for easy operation
- Zero Automatic adjustment
- Sampling Rate: 2.5 times per second
- Includes x 6 "AA" batteries, test leads and carrying case



144-5339 ET5300, 2kΩ

Infrared Thermometers

- IR non-contact mode
- Pocket sized pistol grip
- Built-in laser sighting
- Backlit LCD display
- 123-2217 also accepts a plug-in type-K thermocouple probe (-150°C to +1350°C)



123-2216 -20°C to +500°C

123-2217 -150°C to +1350°C

Magnetic Field Indicator / Solenoid Testers

- Powerful red light in the tip to indicate the presence of a magnetic field.
- Easy to use.
- Solenoid valves in pneumatic and hydraulic control equipment can easily be tested.



375-5422 0.3mT, 1000V ac

141-1996 ATEX, 0.3mT

Resistance Decade Box

- Decade box for electrical resistance measurement
- Heavy-duty construction for durability in harsh environments
- 7-decade ranges from 1 to 111Ω in 1Ω increments
- Separate grounding terminal, isolated substitutions
- Powered by 0.3W resistors, versatile for various applications



193-8686 R-100

Voltage Tester

- LED display indicator for visual notification
- Audible buzzer for enhanced notification
- Wide operating temperature range
- IP67 rating for protection from dust and liquid



161-1627 LED Display, Buzzer Indicator & Torch

Probe Sets

- 0.7mm (0.028") O.D. Back Probe Pins
- Ideal for fuel injectors, sensors, weather pack connectors
- Compatible with industry-standard 4mm plugs
- Perfect complement to test leads
- Cable piercer option minimizes cable damage



124-7405 Ultra Thin Back Probes, Black/Red

124-7402 Ultra Thin Back Probes with Cable Piercer, Black/Red

Multimeter Test Lead

- Crocodile clip jaws will open to 5.5 mm at the tips
- Pack of 10: 2 x red, 2 x black, 2 x Green, 2 x yellow and 2 x white



161-6511 0.5m, Pack of 10

Tape Measure

- Self-locking mechanism allows blade to be extended smoothly
- Push button allows blade to be retracted smoothly
- Nylon coated blade for maximum durability
- Impact resistant rubberized case



254-6240	3m
851-3541	5m
254-6242	8m

Self Adhesive Measuring Tape

- 1.2m steel measuring tape
- White power coated finish
- Self-adhesive backed



706-8141	1.2m
706-8145	1.2m / 4ft

Magnetic Steel Rule

- Suitable for fixing to machine guides, fixed guillotine blades and sheet metal during marking out
- Rule contains encapsulated button magnets
- Rigid satin chrome steel rule conforms to BS4372
- Etched graduations and markings are black paint filled to provide excellent clarity



387-0098	600mm
----------	-------

Laser Distance Measure

- Designed for quick, non-contact measurement of areas and volumes of rooms, heights, distances and angles
- Light & pocket-sized digital measure for easy transport
- Records up to 20 points, with laser pointer targets
- LCD status indicator and distance calculator functionality

**IP54
RATED**



254-6241	0.05 □ 50m Range, ±1.5 mm Accuracy
----------	------------------------------------

Multifunctional Laser Level

- Single button control & professional accuracy
- Green beam laser projects from multiple angles
- Rotatable 360-degree with magnetic 'L' mount
- Soft-grip, light weight design & easy carrying – supplied with a nylon bag



230-7854	Self-levelling laser
----------	----------------------

High Impact Spirit Level

- Sturdy design with strong non-magnetic base
- Electrostatic powder coating
- Frame constructed from aluminium
- 2 Vials – horizontal and vertical
- Accuracy ±0.5 mm/m



851-3541	250mm
----------	-------

Box Spirit Levels

- Aluminium box section spirit levels with two solid block vials that will never leak, fade, fog or break
- Strong and robust, designed for professionals to give accurate results
- Available in a choice of lengths



851-3557	16"
851-3551	24"

Pocket Level

- 0.5 mm/m (0.029°) accuracy
- Ultrasonic welded block vials
- Rigid aluminium box section
- Shockproof end caps
- Built-in magnets

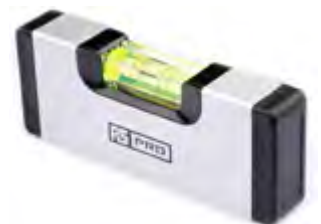

194-4705	120mm
----------	-------

Measuring And Cutting Tool Kit with Foam Inlay

- General-purpose compact workshop measuring and cutting toolset
- Contains precision measuring tools and heavy-duty cutting tools
- The bright red foam helps identify missing parts quickly
- Foam tool modules are designed for regular easy removal from drawers



833-5944 6 Pcs - Electricians scissors, Straight snip, Snap-off utility knife, Measuring tape, Stainless steel ruler, Leaf metric feeler gauge

Digital Vernier Caliper

- A digital vernier caliper with stainless steel rule & jaws, and offering 4 way measurement
- Measurement range of 0mm and 150mm or 0mm and 200mm with a resolution of 0.0005in, 0.01mm



243-6616 150 mm/6", Metric

243-6615 150 mm/6", Imperial/Metric

243-6617 200 mm/8", Imperial/Metric

Fine Adjustment Vernier Caliper

- Vernier Caliper with hardened Stainless Steel frame and jaws for extremely accurate outside, inside, step and depth measurements.
- Dual scale with both metric and imperial readings
- Manufactured from hardened steel
- Fine adjustment mechanism with lockscrews



841-2533 300mm/ 12in, Imperial/Metric

Folding Lock Back Trimming Knife

- Heavy duty retractable
- Blade lock promotes not only safety but also helps with keeping the blade in a good condition, the blade auto-lock contributes to easy storage of the knife too
- The main body is comprised of aluminium
- Ergonomically designed handle helps with the handling of the knife, this also helps add pressure to the nose of the blade knife when being used to cut materials such as plasterboards, wire and carpets
- Accepts industry standard blades



789-4596 80 mm x 30 mm

Standard Utility Knife Blades

- Heavy duty knife blades for trimming knife
- Available in packs of 5 and 10



613-460 5 x concave

546-758 5 x heavy duty

613-454 5 x hooked

541-6646 10 x trapezoid

7 Drawer Cabinet

- Sturdy, premium sheet steel construction
- Electrostatic powder coating, scratch-resistant
- 7 fully extendible drawers with tool module compatibility
- Smart-Lock™ system prevents accidental opening
- Smooth telescopic ball bearing slides
- Central locking, holders for spray cans and paper rolls
- Recessed worktop with quality mat



833-5900 7 Drawers, 975 x 710 x 450, 66.4 kg

833-5903 7 Drawers, Jumbo Size, 975 x 890 x 450, 72.5 kg

Tool Chests

- Electrostatic matt powder coated, scratch proof.
- 80 mm deep top locker.
- Integrated carrying handles.



768-1671 6 Drawers, 350mm x 530mm x 340mm, 18kg

768-1678 3 Drawers, 365mm x 620mm x 440mm, 20kg

Drill Bit Case with Organiser

- 11 trays to help keep things organised
- Lightweight
- Transparent lid to make selections easier
- Anti-migration bars to ensure small parts stay in place
- Strong clasps



838-6529 11 trays

Drawer Unit

- Stackable, wall mountable small parts storage
- Dividable drawers with drawer stops
- Supplied with dividers and ID labels



178-3331 15 Drawer Cabinet

178-3368 36 Drawer Cabinet

Plastic Compartment Box with Adjustable Dividers

- Secure double lock
- Tough transparent lid with anti-migration bars to ensure small parts stay in place
- Integrated ergonomic handle
- 17 compartments - with movable dividers



435-0179 395 x 305 x 60mm

Slide-locking Box

- Strong hinges, sliding locks
- Ideal for the storage of nuts, washers, screws and small component parts



784-6058 12 Compartments

Instrument Bags

- Padded bags designed for the safe transportation of sensitive electronic equipment, tools and components
- Constructed from tough, waterproof Polyester with removable base board



707-7338	300x150x250mm
707-7331	360x150x280mm
707-7335	445x170x330mm

Tool Belts

- Constructed from tough padded tear resistant polyester
- Double fastening adjustable belt (90 – 120 cm)
- Modular tool belt comprising of 3 separate sections
- Drill holster with secure strap



788-7220 Electricians tool pouch

Tool Case

- Waterproof (IP67)
- Dustproof
- Impact/shock resistant
- Stackable
- Soft-grip carry handle
- Lockable with padlock (not included)

**IP67
RATED**



125-3049 530 x 180 x 400mm, 5kg

Plastic Tool Box

- Removable tote tray for quick access to small parts
- Two built-in organisers with lids for the sorting and storage of fasteners and fixings
- Telescoping design carry handle for easy transportation and a compact design



833-5988 19"

Rucksacks and Toolbags

- 16" rucksack with reflective piping
- Comfortable padded shoulder straps
- Double zipped bottom section
- Mobile phone/mp3 player holder on strap



788-7211 16"

Tool Bag With Shoulder Strap

- Constructed with tear-resistant padded polyester, with a durable welded waterproof plastic base. This ensures that your cargo is adequately protected against the elements and casual impacts.



788-7205 310mm x 200mm x 210mm

Tool Balancers

- Suitable for a wide range of drivers
- Cord with cable stop
- Durable plastic composite housing designed to hang overhead



793-2774	0.5-1.2kg
793-2777	1.0-2.0kg
793-2771	2.0-3.0kg

Duct Tape

- Adhesion strength of 3.5 Newton centimetres (N/cm) to 5.5 N/cm
- Adhesive material made from rubber resin
- Fabric backing material
- Elongation at break of 0.24
- Gloss finish
- Thickness of 0.23 mm
- Maximum operating temperature of +80°C
- Minimum operating temperature of -50°C
- Tensile strength of 32 Newton centimetres (N/cm)



146-7415	Yellow, 50mm x 50m, Gloss Finish
146-7416	Silver, 50mm x 50m, Gloss Finish
146-7418	Red, 50mm x 50m, Gloss Finish
146-7419	Blue, 50mm x 50m, Gloss Finish
146-7414	Black, 50mm x 50m, Gloss Finish

PTFE Extra Thick PTFE Tape

- Extra thick PTFE tape designed for sealing threads in just one wrap
- Only requires 50% overlap on the thread for BS21 thread up to 2 inches.
- Suitable for more aggressive environments where acids, gases or solvents may be present
- Easy to apply and handle
- Robust pressure resistant



231-964	White, 12mm x 5m, 0.2mm Thick
183-3490	White, 12 mm x 12 m x 0.075 mm

Double Sided Paper Tape

- Easy to tear and flexible, allowing for minimal application and installation time, especially when working with irregular or round surfaces
- Paper coated tape with an aggressive specially constructed adhesive, which is then interleaved with a release liner for fuss-free use
- RoHS compliant



223-1093	White, 50mm x 50m, 0.1mm Thick
223-1087	White, 25mm x 50m, 0.1mm Thick
223-1080	White, 19mm x 50m, 0.1mm Thick
125-4306	White, 9 mm x 50 m
125-4304	White, 25 mm x 50 m
125-4303	White, 15 mm x 50 m
125-4302	White, 12 mm x 50 m
223-1094	Yellow, 50 mm x 50m

Self Amalgamating Tapes

- Easy unwind & extremely flexible
- Resistant to water, ozone and UV
- Excellent low and high temperature performance as well as excellent conformability to awkward shapes
- Breaking load is 20.0N/cm and elongation is 600%



146-8999	Black, 50mm x 10m
146-8998	Black, 25mm x 10m
146-9000	Black, 19mm x 10m

Clear PP Double Sided Tape

- Flame retardant
- PP film coated tape with thin gauge polycarbonate film with polished surfaces on each side
- Easy to tear and flexible, allowing for minimal application and installation time, especially when working with irregular or round surfaces



223-1085	Clear, 38 mm x 50m
223-1092	Clear, 38 mm x 50m

PVC insulating tapes

- UV resistant
- Water resistant
- Flame retardant
- Self-extinguishing
- Easy to tear by hand
- Breakdown Voltage 8000V
- Compliant to EN 60454-3-1 Type 2



Stock No.	Colour	Thickness	Length
134-7321	Black	12 mm	20 m
134-7329	Black	38 mm	20 m
134-7319	Black	19 mm	33 m
134-7330	Blue	12 mm	20 m
134-7324	Blue	19 mm	33 m
134-7334	Green	12 mm	20 m
134-7331	Green	19 mm	33 m
134-7325	Green	12 mm	20 m
134-7328	Green	19 mm	33 m
134-7327	Red	12 mm	20 m
134-7323	Red	19 mm	33 m
134-7333	White	12 mm	20 m
134-7335	White	38 mm	20 m
134-7320	White	19 mm	33 m
134-7332	Yellow	12 mm	20 m
134-7326	Yellow	19 mm	33 m

Double Sided PVC Tape

- Designed for high adhesion, heavy-duty applications, offering secure and long-lasting attachment to surfaces for complete peace of mind
- PVC film coated tape with an aggressive clear acrylic adhesive, which is then interleaved with a release liner for fuss-free use
- Strong adhesive properties that make it resistant to high temperatures, U.V and difficult substrates



223-1090	Yellow, 38 mm x 50m
223-1083	Yellow, 19mm x 50m, 0.245mm Thick
223-1077	Yellow, 12 mm x 50m, 0.245mm Thick

Foam Tapes

- Low density PVC foam sealing strips
- Closed cell construction gives a positive seal at only 30% compression
- Seal cabinets, enclosures and machines against light, dust, moisture etc.



205-0912	Grey, 9mm x 30m, 3mm Thick
205-0805	Grey, 6mm x 30m, 3mm Thick
205-0940	Grey, 25mm x 15m, 6mm Thick
733-6797	Grey, 5 m x 20 mm x 6.4 mm
733-6785	Grey, 15mm x 5m, 3.2mm Thick
733-6781	Grey, 12mm x 5m, 2.4mm Thick
205-0833	Grey, 12mm x 30m, 3mm Thick
205-0928	Grey, 12mm x 30m, 3mm Thick
205-0883	Black, 25mm x 15m, 6mm Thick
205-0906	Black, 25mm x 10m, 10mm Thick
619-1786	Black, 20mm x 10m, 5mm Thick
619-1770	Black, 20mm x 10m, 3mm Thick
619-1764	Black, 15 m x 10 mm x 5 mm
619-1758	Black, 15mm x 10m, 3mm Thick
205-0861	Black, 12mm x 30m, 3mm Thick
205-0877	Black, 12mm x 15m, 6mm Thick
567-963	Black, 12mm x 10m, 3mm Thick
205-0899	Black, 12mm x 10m, 10mm Thick
619-1742	Black, 10mm x 10m, 5mm Thick
619-1720	Black, 10 m x 10 mm x 3 mm

Reflective tape

- Specially designed for application to plastic and rough substrates
- Should be applied at temperatures between 0°C and +25°C
- Recommended for use on flat surfaces



219-7897	Black/Yellow, 50mm x 25m
219-7881	Black/Yellow, 100mm x 25m

PPE & SITE SAFETY

RS PRO have personal protective equipment for any electrical application and the products you need to keep your site safe and secure.

General Purpose Nylon Polyurethane-Coated Reusable Gloves

- Ultrane 548 Polyamide (nylon) knitted gloves with palm and fingers coated with black Polyurethane foam
- Elastic knit wrist
- Popular and cost effective alternative to the Rigger Glove
- Textured external surface
- Length: 24 - 26cm
- Bag of 12 pairs supplied



475-693 9 - M
475-697 10 - L

Cut Resistant Latex-Coated Cut Resistant Gloves

- EN388 Cut level 5 protection
- Perfect for working environments where there is a cut risk
- Water resistant
- Extra grip coating



869-1610 8 - S
869-1613 9 - M
869-1617 10 - L

Leather Welding Gloves

- Premium quality chrome leather (LW93)
- Weltd Seams protect against thermal and mechanical discharge
- Thermal Lining improves comfort and contact heat protection
- Specifically designed for type A (Mig / Arc welding) and light mechanical handling
- Compliant with BS EN 12477 - Welding Standard
- Suitable for heavy duty thermal welding applications
- length: 350mm



622-7071 Red

Bump Cap

- High-profile ABS shell acts as a shock absorber and comes with a soft padded crown, giving optimum safety and protection for the wearer
- Features a short peel of 3cm which allows for increased upward and better peripheral visibility
- Made from 100% cotton, ABS and EVA Foam



918-5674 Grey/Orange
918-5670 Black/Red

Cup Shaped Respirators

- Soft foam nose seal
- Adjustable nose bridge
- Twin elasticated head fitting band
- Comfortable
- One size fits all
- Disposable



918-5822 FFP1 Fold Flat Respirator
918-5826 FFP2 Fold Flat Respirator
918-5829 FFP3 Valved Dolomite Respirator

Hi-Vis Vest Waistcoat

- High visibility
Reflective tape marking – increased visibility
Contrast panels for dirt protection



141-8168 Yellow, S
141-8169 Yellow, M
141-8170 Yellow, L
141-8174 Yellow, XL
141-8176 Yellow, XXL

Lockout Hasp

- Plated to resist chemicals and rust
- Manufactured from high tensile steel
- Thick vinyl covered padlock section to resist wear
- Each lockout accepts up to 6 padlocks with up to 9.5mm shackle diameter
- Available in two sizes, 25mm or 38mm jaw diameter



805-5506 25mm, 6 lock

805-5500 38mm, 6 lock

818-8041 16 padlock lock out station

Lockout Starter Kit

- Portable electrical department lockout tag out kit
- Provides all the basic Lockout for valves and electrical panels
- Comprises of around 24 different products
- Supplied in a tough LOTO caring bag (with handle and shoulder carrier)



862-5247

862-5244 27 Piece Kit

Miniature Circuit Breaker Lockout

- Safe and effective method for locking out miniature circuit breakers (MCB's)
- Can easily be installed with the aid of a screw driver
- Can be used on single and multipole breakers
- Single lockout padlock (not supplied), can be installed on each lockout device



862-5193 Green

862-5203 Yellow

Stainless Steel Lockout Hasp

- Has space for up to 6 individual padlocks with a shackle diameter up to 6 mm
- The padlock fixing is divided in to 3 holes and three lock combination bar
- Suitable for use in corrosive areas and near sea shore areas



862-5155 25 mm jaw diameter

Electric Flash Symbol Sign

- Self-Adhesive Electrical Hazard Warning Sign



776-0945 Vinyl Label 150 mm x 150mm

813-4423 Vinyl Label 100 mm x 100mm

776-0948 Vinyl Label 25 mm x 25mm, 250

776-0967 Vinyl Label 50 mm x 50mm, 250

Heavy Duty Cable Protectors

- Available with 2, 3 or 5 grooves which can be accessed via a top hood.
- Weather and skid proof
- Black base and yellow cover provide good visibility
- Can withstand up to 20 tons per axle
- Parts fit into one another for strong connection
- Fixed to the ground via 4 fixing holes, Ø 6 mm
- RoHS compliant



136-5423 2 channels, 32/38mm

Photoluminescent floor/wall guiding

- For sudden power failure/no lights
- Hazard warning and emergency exit
- Indoor use only



261-0520 Left, 40 mm (W) x 10 m (L)

261-0542 Right, 40 mm (W) x 10 m (L)



WE ARE WHERE YOU ARE ALL ACROSS AUSTRALIA & NEW ZEALAND

Our network of three distribution centres in Australia & New Zealand provides a fast and dependable national delivery service with a local stock of RS PRO products.

RS Components Pty Ltd
25 Pavesi Street
Smithfield, NSW 2164
Australia

Trident Australia
15 Magnet Road
Canning Vale, WA 6155
Australia

RS Components Ltd
Māngere, Auckland 2022,
New Zealand

Our infrastructure and extensive delivery capabilities means we can offer exceptional service wherever you are, whatever you need, whenever you need it.

All supported by our team of dedicated Local Account Managers in located in every state and territory along with our Customer Services and knowledgeable Technical Helpdesk teams.

If you'd like to start exploring the RS PRO now, head over to our website browse the vast range.

To make an enquiry contact your RS Account Manager, visit:

rspro.com

