



ELECTRICAL CONTROL PANEL RANGE

Discover RS PRO, the value alternative at the right price.

Find single components to enclosures - and everything from power supplies to push buttons - RS PRO offers the parts you need to build, maintain or level-up your industrial control panels.



YOUR SMART CHOICE FOR CONTROL PANELS

Discover RS PRO, the own brand, of RS, and our wide range of quality products across all industries. Our value alternative at the right price.

RS PRO offers customers with one brand that gives huge choice and solutions, proven quality and prices that can be trusted.

The wide range of electrical products from RS PRO covers all you need to build industrial control panels and beyond from quality products you can trust.

Since 1937, RS PRO has had a passion for industrial parts. More importantly, we believe that every part matters, because the quality of your applications will always be linked to the quality of every part going into them.

This is why we rigorously test every part against demanding industry standards to gain the RS PRO Seal of Approval.

THE WINNING COMBINATION FOR YOUR INDUSTRIAL SUPPLIES



Our products are tested for great performance and only awarded after a rigorous quality process to demanding international standards.



A combination of quality and choice, and sustainable product solutions, with competitive pricing against branded alternatives.



Over 80,000 products available with a low return rate of less than 0.02%.



Our products come with a 3-year warranty, where applicable.



TECHNICAL REFERENCE CHARTS**6**

| | |
|---------------------------------|---|
| Ingress Protection (IP) Ratings | 6 |
| Wire Gauge Size Chart | 7 |
| 3 Phase Motor Starting Currents | 7 |

CONTROL & SIGNALLING DEVICES**8**

| | |
|---|----|
| Plastic Modular Series - Non-Illuminated Heads | 9 |
| Plastic Modular Series - Illuminated Heads | 10 |
| Plastic Modular Series - Contact & Light Blocks | 11 |
| Plastic Monoblock Series | 12 |
| Metal Modular Series | 14 |
| Push Button Enclosures & Legend Plates | 15 |
| Automation Signalling & Safety | 16 |
| Switches | 17 |

PROGRAMMABLE CONTROL DEVICES**18**

| | |
|------------------------------|----|
| Programmable Control Devices | 19 |
| Temperature Controllers | 20 |

PROCESS CONTROL & PROTECTION**22**

| | |
|----------------------------|----|
| Relays | 24 |
| Motor Control & Protection | 26 |

CONTROL CABINET WIRING**28**

| | |
|-------------------------------------|----|
| Wire Cutters & Strippers | 29 |
| Cable Markers | 30 |
| Tapes and Heat-Shrinks | 31 |
| Crimp Terminals & Tools | 32 |
| Bootlace Ferrules & Crimping Pliers | 33 |
| Cable Ties | 34 |

WALL BOXES & ACCESSORIES**36**

| | |
|--|----|
| Wallboxes & Accessories | 37 |
| Isolators & Disconnectors | 38 |
| Axial Fans | 39 |
| Cable Glands | 40 |
| Cable Tray, Trunking & Protectors | 42 |
| Cable Conduit | 43 |
| Terminal Blocks & Accessories | 44 |
| DIN Rail Terminal Blocks & Accessories | 46 |
| Fuses & Fuse Holders | 48 |
| Cable Conduit | 49 |

FACTORY AUTOMATION SENSORS**50**

| | |
|--|----|
| Factory Automation Sensors & Accessories | 51 |
| Photoelectric Sensors - Barrel | 52 |
| Proximity Photoelectric Sensors - Block | 54 |
| Proximity Capacitive Sensors | 56 |
| Accessories & Related Products | 58 |

TOOLS & CONSUMABLES**59**

| | |
|-------------------------------------|----|
| Tool Kits | 61 |
| Insulated Tools | 64 |
| Pliers | 68 |
| Spanners & Sockets | 70 |
| Power Tool Accessories & Drill Bits | 72 |
| Electrical Test Equipment | 74 |
| Linear Measurement & Cutting Tools | 76 |
| Tool & Consumables Storage | 78 |
| Tapes | 80 |

PPE & SITE SAFETY**82**

| | |
|------------------------|----|
| Site Safety & Security | 83 |
|------------------------|----|

To view our latest prices, charges and full terms see RS Conditions of Sale as set out online at sg.rs-online.com, my.rs-online.com, ph.rs-online.com and th.rs-online.com.

Published by: RS Group Plc

Registered offices:

Singapore: 133 Cecil Street #14 - 01 Keck Seng Tower Singapore 069535

Malaysia: Suite 12-9, The office Club, Level 12, Menara Mudajaya, No 12A, Jalan PJU 7/3 Mutiara Damansara, 47810 Petaling Jaya, Selangor

Philippines: 21/F Multinational Bancorporation Centre 6805 Ayala Avenue Makati City Philippines 1226

Thailand: 50 GMM Grammy Place, 19th Floor, Unit 1901-1904, Sukhumvit 21 Road (Asoke), Kongtoey Nua, Wattana, Bangkok Thailand 10110

EVERYTHING YOU NEED TO BUILD AND MAINTAIN YOUR PANEL

RS PRO offering for panel building allow you to build and maintain you panel according to your needs, with high quality components and a wide choice to meet industrial requirements.

INSIDE THE PANEL

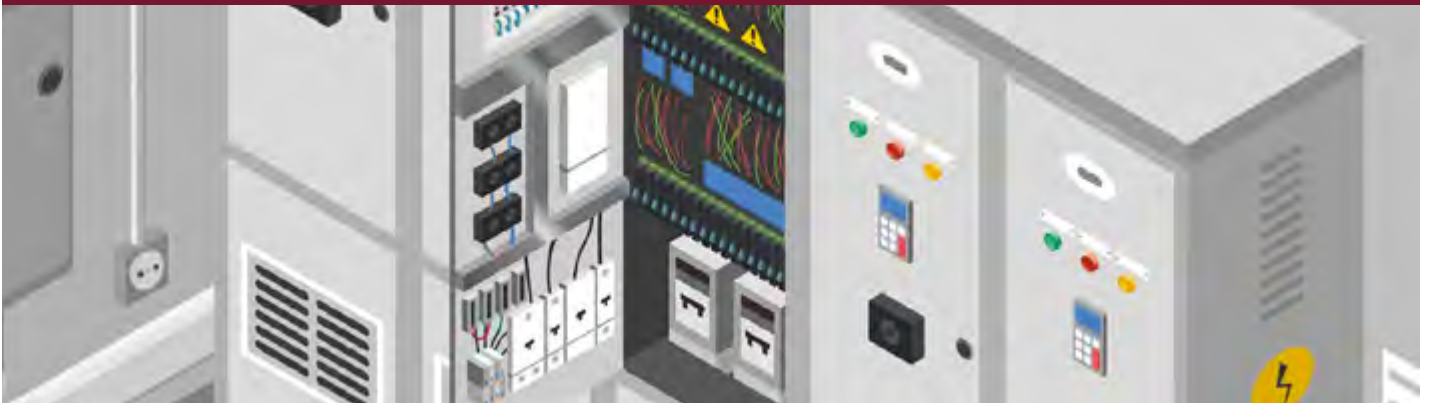

DIN Rail Power Supply



Ethernet Switches



Relays



- General purpose
- Solid State
- Interface Module
- Control Relay

Timers



Time Switches



Terminal Blocks



- DIN Rail Terminal Blocks
- Distribution Blocks
- DIN Rail Terminal Accessories
- Terminal Block Accessories

Surge Suppression



Enclosure



- Enclosure Heaters
- Wall Boxes
- DIN Rail Enclosure
- Enclosure Accessories
- DIN Rails

Cable & Wires



- Hookup & Equipment Wire
- Coaxial Cables
- Multicore Cables
- Network & Communication Cables
- Ribbon & Flat Cables
- Slotted Panel Trunking

Axial Fans



Related Products

CABLE GLANDS, STRAIN RELIEF & GROMMETS



CABLE TIES



CIRCULAR CONNECTORS



HEAT-SHRINK & COLD-SHRINK SLEEVES



WIRE TERMINAL & SPLICES



CABLE, CONNECTOR & CRIMPING TOOLS



TOOL KITS



ELECTRICAL TEST EQUIPMENT



DIGITAL MULTIMETERS



WIRE STRIPPERS



CABLE MARKING



THERMAL IMAGING CAMERAS



OUTSIDE THE PANEL



Switches



- Industrial Switches
- Industrial Push Buttons
- Push Button Switches
- Rocker Switches
- Key Switches
- Toggle Switches

Counters



Ammeters



Voltmeters



Energy Meters



Multi Function Panel Meters



Temperature Controllers



Sounders & Beacons



Indicators



HMI



Thermostats



Fan Filters



Related Products

CABLE GLANDS, STRAIN RELIEF & GROMMETS



INDUSTRIAL POWER CONNECTORS



HEAVY DUTY CONNECTORS



CABLE, CONNECTOR & CRIMPING TOOLS



TOOL KITS



ELECTRICAL TEST EQUIPMENT



INDUSTRIAL EXTENSION LEADS



DIGITAL MULTIMETERS



INDUSTRIAL AUTOMATION CABLE ASSEMBLIES



EXTENSION LEADS & CABLE REELS



LAN CABLE ASSEMBLIES



POWER CABLE ASSEMBLIES



TECHNICAL REFERENCE CHARTS

INGRESS PROTECTION (IP) RATINGS

The Ingress Protection (IP) rating system is an internationally recognized scale that relates to proven protection against environmental factors such as liquids and solids.

Ingress protection ratings can be identified by the letters IP, followed by two numbers. These numbers define the amount of protection a digital scale has against specified elements and its ability to resist foreign matter that could otherwise get inside the product and cause it to fail.

1ST DIGIT = Degree of protection against solid objects

No Protection

0

Protected against solid objects greater than 50mm.

1

Protected against solid objects greater than 12.5mm.

2

Protected against solid objects greater than 2.5mm.

3

Protected against solid objects greater than 1.0mm.

4

Protected against dust that could cause sufficient harm.

5

Protected against all dust.

6

2ND DIGIT = Degree of protection against water

No Protection

0

Protected against drops of water.

1

Protected against drops of water at a 15 degree angle.

2

Protected against water spray at a 60 degree angle.

3

Protected against water spray splashing from any angle.

4

Protected against water jets from any angle.

5

Protected against powerful jets of water or heavy seas.

6

Protected against temporary immersion in water (30 minutes at 1M).

7

Protected against the effects of permanent immersion in water (up to 5M).

8

Protected against close-range high pressure, high temperature spray downs (80 degC water at 80-100bar for 30sec x 4 angles.

9K

Example:

IP

4

4

Protected against solid objects greater than 1.0mm.

Protected against water spray splashing from any angle.

WIRE GAUGE SIZE CHART

American wire gauge (AWG) is a standardized wire gauge system for the diameters of round, solid, nonferrous, electrically conducting wire. The larger the AWG number or wire gauge, the smaller the physical size of the wire. The smallest AWG size is 40 and the largest is 0000 (4/0). AWG general rules of thumb - for every 6 gauge decrease, the wire diameter doubles and for every 3 gauge decrease, the cross sectional area doubles.

| AWG/KCMIL No. | Diameter section (mm) | Cross geometric (mm ²) | Conductor resistance (Ω/km) |
|---------------|-----------------------|------------------------------------|-----------------------------|
| 500 | 17.96 | 253 | 0.07 |
| 350 | 15.03 | 177 | 0.1 |
| 250 | 12.7 | 127 | 0.14 |
| (4/0) | 11.68 | 107.2 | 0.18 |
| (3/0) | 10.4 | 85 | 0.23 |
| (2/0) | 9.27 | 67.5 | 0.29 |
| (1/0) | 8.25 | 53.5 | 0.37 |
| 1 | 7.35 | 42.4 | 0.47 |
| 2 | 6.54 | 33.6 | 0.57 |
| 4 | 5.19 | 21.2 | 0.91 |
| 6 | 4.12 | 13.3 | 1.44 |
| 8 | 3.26 | 8.37 | 2.36 |
| 10 | 2.59 | 5.26 | 3.64 |
| 12 | 2.05 | 3.31 | 5.41 |
| 14 | 1.63 | 2.08 | 8.79 |
| 16 | 1.29 | 1.31 | 14.7 |
| 18 | 1,024 | 0.823 | 23 |
| 20 | 0.813 | 0.519 | 34.5 |
| 22 | 0.643 | 0.324 | 54.8 |
| 24 | 0.511 | 0.205 | 89.2 |
| 26 | 0.405 | 0.128 | 146 |
| 28 | 0.32 | 0.0804 | 232 |
| 30 | 0.255 | 0.0507 | 350 |
| 32 | 0.203 | 0.0324 | 578 |
| 34 | 0.16 | 0.02 | 899 |
| 36 | 0.127 | 0.0127 | 1426 |
| 38 | 0.102 | 0.00811 | 2255 |
| 40 | 0.079 | 0.00487 | 3802 |
| 42 | 0.064 | 0.00317 | 5842 |
| 44 | 0.051 | 0.00203 | 9123 |

3 PHASE MOTOR STARTING CURRENTS

Calculate starting, running & full-load current of 3 phase AC induction motor.

| Motor Rating | | Power Factor | Efficiency % | 230V | | | 400V | | |
|--------------|------|--------------|--------------|----------------------|----------------------------|-----------------------------------|---------------------|----------------------------|-----------------------------------|
| | | | | Rated motor current* | 230V Fuse for DOL starting | 230V Fuse for star delta starting | Rated motor current | 400V Fuse for DOL starting | 400V Fuse for star delta starting |
| kW | HP | cosφ | % | A | A | A | A | A | A |
| 0.37 | 0.5 | 0.72 | 66 | 2 | 6 | 4 | 1.1 | 4 | 2 |
| 0.55 | 0.7 | 0.75 | 69 | 2.7 | 10 | 4 | 1.5 | 4 | 2 |
| 0.75 | 1 | 0.79 | 74 | 3.2 | 10 | 4 | 1.9 | 6 | 4 |
| 1.1 | 1.5 | 0.81 | 74 | 4.6 | 10 | 6 | 2.6 | 6 | 4 |
| 1.5 | 2 | 0.81 | 74 | 6.3 | 16 | 10 | 3.6 | 6 | 4 |
| 2.2 | 2.9 | 0.81 | 78 | 8.7 | 20 | 10 | 5 | 10 | 6 |
| 3 | 4 | 0.82 | 80 | 11.5 | 25 | 16 | 6.6 | 16 | 10 |
| 4 | 5.4 | 0.82 | 83 | 14.8 | 32 | 16 | 8.5 | 20 | 10 |
| 5.5 | 7.4 | 0.82 | 86 | 19.6 | 32 | 25 | 11.3 | 25 | 16 |
| 7.5 | 10.1 | 0.82 | 87 | 26.4 | 50 | 32 | 15.2 | 32 | 16 |
| 11 | 14.7 | 0.84 | 87 | 38 | 80 | 40 | 21.7 | 40 | 25 |
| 15 | 20.1 | 0.84 | 88 | 51 | 100 | 63 | 29.3 | 63 | 32 |
| 18.5 | 24.8 | 0.84 | 88 | 63 | 125 | 80 | 36 | 63 | 40 |
| 22 | 29.5 | 0.84 | 92 | 71 | 125 | 80 | 41 | 80 | 50 |
| 30 | 40.2 | 0.85 | 92 | 96 | 200 | 100 | 55 | 100 | 63 |

CONTROL & SIGNALLING DEVICES

From push buttons to emergency stop buttons, from key-operated to panel-mount selector switches - we have extended our offering to meet your every need.

22mm Control & Signalling Devices

The new RS PRO range of 22mm push buttons, indicator lights and switches are the perfect solution for OEMs and panel builders in almost every industry. The RS PRO offer consists of modular variants in metal or plastic which allow customers to flexibly configure their control device of choice. In addition to the modular system, RS PRO also offer complete mono-style types which allow easy stock management and installation. All products are fully sealed with an IP65 rating to protect sensitive components inside the panel from ingress of dust and water.

All products in the following guide are ROHS compliant, UL listed and conform to CE IEC and several others. The full range is tested in the RS PRO laboratory to different electrical and mechanical endurance tests as per different global electrical standards.

The manufacturing sites of our RS PRO push buttons have adopted green practices which have helped to reduce the wastage of plastic and other harmful products. They have also incorporated sustainable practices to reduce the consumption of electricity. RS PRO puts the highest focus across all our manufacturers with the conscious effort to reduce our carbon footprint.

PLASTIC MODULAR SERIES

- Non-Illuminated Heads - Push Button, Selector Switch & Key Switch
- Illuminated Heads - Push Button, Selector Switch & Indicator
- Light Blocks
- Contact Blocks

PLASTIC MONOBLOCK SERIES

- Non-Illuminated Heads - Push Button, Selector Switch & Key Switch

METAL MODULAR SERIES

- Non-Illuminated Heads - Push Button, Selector Switch & Key Switch
- Contact Blocks

ACCESSORIES

- Enclosures
- Legend Plates

Double Push Button Head

- Double push button heads for use with the RS PRO modular plastic push button series.
- Robust design, illuminated and non-illuminated versions with modern silver coloured bezel.
- Simple installation via standard lock nut.

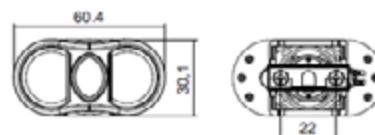
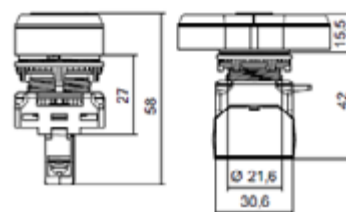

Stock No. 

Colour

188-1200



Green / Red

Push Button Heads

- Non-illuminated raised and flush push button heads for use with the RS PRO modular plastic push button series. Robust designs in a variety of colours with modern silver coloured bezel.
- Simple installation via standard lock nut.
- Spring Return head
- Contact block mounting clip included
- Stackable design for contact blocks (max 6)
- Mechanical life more than 1 million uses

IP65 RATED

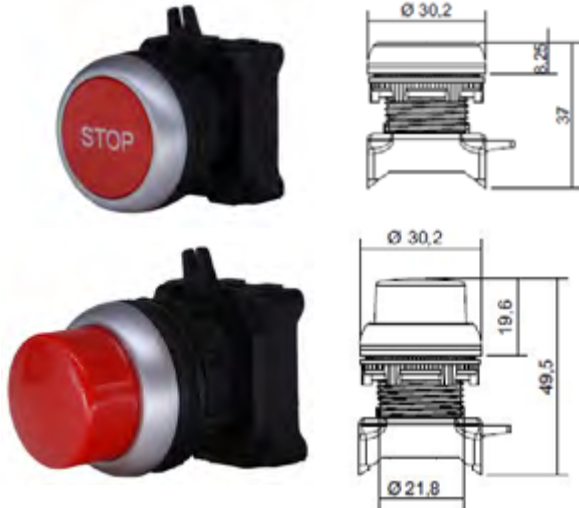

| Stock No. | Style | Colour | Print |
|-----------|--------|--------|-------------|
| 188-1129 | Raised | | Red N/A |
| 188-1130 | Raised | | Green N/A |
| 188-1122 | Flush | | Blue N/A |
| 188-1123 | Flush | | Red N/A |
| 188-1124 | Flush | | Green N/A |
| 188-1126 | Flush | | Yellow N/A |
| 188-1127 | Flush | | Black N/A |
| 188-1128 | Flush | | White N/A |
| 188-1132 | Flush | | Red O |
| 188-1133 | Flush | | Green |
| 188-1134 | Flush | | Red STOP |
| 188-1137 | Flush | | Blue RESET |
| 188-1138 | Flush | | Black ↑ |
| 188-1139 | Flush | | Black ↓ |
| 188-1140 | Flush | | Green START |

Selector Switch Heads

- 2 or 3 position selector switch heads for use with the RS PRO modular plastic push button series.
- Robust design with modern aesthetics delivered via silver coloured bezel.
- Simple installation via standard lock nut.
- Latching and Spring return head options.
- Contact block mounting clip included.
- Stackable design for contact blocks (max 6)
- Mechanical life more than 1 million uses

IP65 RATED



| Stock No. | Positions | Throw Angle | Switch Actuation | Actuation Diagram |
|-----------|------------|-------------|------------------|-------------------|
| 188-1148 | 2 Position | 0° – 30° | Return | |
| 188-1151 | 3 Position | -45° – 45° | Latching | |
| 188-1152 | 3 Position | -45° – 45° | Return | |
| 188-1146 | 2 Position | 0° – 30° | Latching | |

Key Switch Heads

- 2 and 3 position key switch heads for use with the RS PRO modular plastic push button series.
- Robust design in black with modern silver coloured bezel. Plastic body with metal look.
- Simple installation via standard lock nut.
- Latching and Spring return head options
- Contact block mounting clip included
- Stackable design for contact blocks (max 6)
- All key switches from the RS PRO plastic modular series are supplied with alike keys
- Keys are removable at 0 - position

IP65 RATED

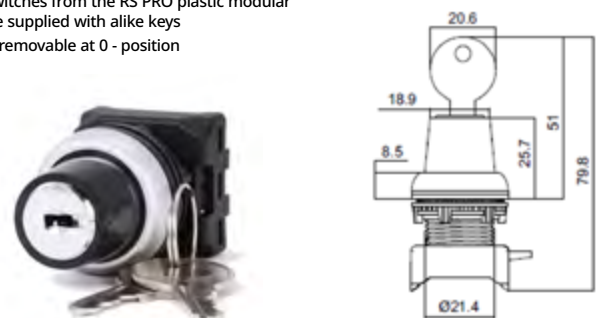

| Stock No. | Positions | Throw Angle | Switch Actuation | Actuation Diagram |
|-----------|------------|-------------|------------------|-------------------|
| 188-1149 | 2 Position | 0° – 30° | Latching | |
| 188-1150 | 2 Position | 0° – 30° | Return | |
| 188-1154 | 3 Position | -45° – 45° | Latching | |
| 188-1155 | 3 Position | -45° – 45° | Return | |

Push Button Heads

- Illuminated flush push button heads for use with the RS PRO modular plastic push button series. Robust designs in a variety of colours with modern silver coloured bezel.
- Simple installation via standard lock nut.
- Spring Return head
- Contact block mounting clip included
- Stackable design for contact blocks (max 6)
- Mechanical life more than 1 million uses

**IP65
RATED**



| Stock No. | Style | Colour |
|-----------|-------|--------|
| 188-1141 | Flush | Blue |
| 188-1142 | Flush | Red |
| 188-1143 | Flush | Green |
| 188-1144 | Flush | Yellow |
| 188-1145 | Flush | White |

Indicator Light Heads

- Indicator light heads for use with the RS PRO modular plastic push button series.
- Simple installation via standard lock nut.
- Panel mounted
- Plastic body

**IP65
RATED**



| Stock No. | Style | Cut Out Ø | Colour |
|-----------|-------------|-----------|--------|
| 188-1201 | Pilot Light | 22.5mm | Red |
| 188-1202 | Pilot Light | 22.5mm | Blue |
| 188-1203 | Pilot Light | 22.5mm | White |
| 188-1205 | Pilot Light | 22.5mm | Yellow |
| 188-1206 | Pilot Light | 22.5mm | Green |
| 188-1207 | Pilot Light | 22.5mm | Orange |

Illuminated Selector Switch Heads

- Illuminated 2 or 3 position selector switch heads for use with the RS PRO modular plastic push button series.
- Robust design in Green, Red and Amber with modern silver coloured bezel.
- Simple installation via standard lock nut.
- Latching and Spring return head options
- Contact block mounting clip included
- Stackable design for contact blocks (max 6)

**IP65
RATED**



| Stock No. | Colour | Positions | Throw Angle | Switch Actuation | Actuation Diagram |
|-----------|--------|------------|-------------|------------------|-------------------|
| 188-1156 | Green | 2 Position | 0° - 30° | Latching | |
| 188-1157 | Green | 2 Position | 0° - 30° | Return | |
| 188-1158 | Red | 2 Position | 0° - 30° | Latching | |
| 188-1159 | Red | 2 Position | 0° - 30° | Return | |
| 188-1160 | Orange | 2 Position | 0° - 30° | Latching | |
| 188-1161 | Orange | 2 Position | 0° - 30° | Return | |
| 188-1162 | Green | 3 Position | 30° - 30° | Latching | |
| 188-1163 | Green | 3 Position | 30° - 30° | Return | |
| 188-1164 | Green | 3 Position | 30° - 30° | Right Return | |
| 188-1165 | Green | 3 Position | 30° - 30° | Left Return | |
| 188-1166 | Red | 3 Position | 30° - 30° | Latching | |
| 188-1167 | Red | 3 Position | 30° - 30° | Return | |

Double Push Button Head

- Double push button heads for use with the RS PRO modular plastic push button series.
- Robust design, illuminated and non-illuminated versions with modern silver coloured bezel.
- Simple installation via standard lock nut.



| Stock No. | Colour |
|-----------|-------------|
| 188-1199 | Green / Red |

Contact Blocks

- Compact for space saving
- Screw and spring terminal versions available
- Stackable design for contact blocks (max 6)
- Mechanical life more than 1 million uses
- Spring return actuation
- Clip mounting type

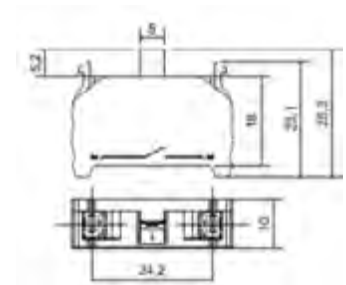

| Stock No. | Actuation | Terminal | Contacts | Switching Capacity | Mounting Type |
|-----------|---------------|----------|----------|-------------------------------|---------------|
| 188-1168 | Spring Return | Screw | NO | 230V AC / 6A or 24V DC / 1.5V | Clip |
| 188-1169 | Spring Return | Screw | NC | 230V AC / 6A or 24V DC / 1.5V | Clip |

Light Blocks

- LED Light blocks for use with the RS PRO modular plastic push button series (Pilot Lights and Illuminated Push Buttons).
- Simple installation via clip, various voltage ratings available.
- Side view SMD LED technology
- 0.1 million burning hours
- Operating frequency: 50/60Hz
- Operating temp: -25°C - 65°C
- Wire termination capacity: 0.5mm², 1.5 - 2.5mm²
- Terminal torque: 0.8Nm
- Surge test: 2KV
- HV Test for 60 sec: 1.5KV

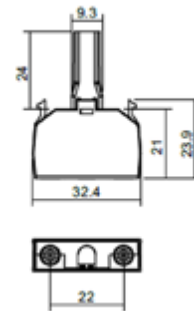

**IP20
RATED**

| Stock No. | Colour | Voltage |
|-----------|--------|-----------|
| 188-1172 | Red | 12V AC/DC |
| 188-1173 | Blue | 12V AC/DC |
| 188-1174 | White | 12V AC/DC |
| 188-1176 | Yellow | 12V AC/DC |
| 188-1177 | Green | 12V AC/DC |
| 188-1178 | Amber | 12V AC/DC |
| 188-1179 | Red | 24V AC/DC |
| 188-1180 | Blue | 24V AC/DC |
| 188-1182 | White | 24V AC/DC |
| 188-1183 | Yellow | 24V AC/DC |
| 188-1184 | Green | 24V AC/DC |
| 188-1185 | Amber | 24V AC/DC |

| Stock No. | Colour | Voltage |
|-----------|--------|---------|
| 188-1186 | Red | 110V AC |
| 188-1187 | Blue | 110V AC |
| 188-1188 | White | 110V AC |
| 188-1189 | Yellow | 110V AC |
| 188-1190 | Green | 110V AC |
| 188-1191 | Amber | 110V AC |
| 188-1192 | Red | 240V AC |
| 188-1193 | Blue | 240V AC |
| 188-1194 | White | 240V AC |
| 188-1195 | Yellow | 240V AC |
| 188-1196 | Green | 240V AC |
| 188-1198 | Amber | 240V AC |

Flush Push Buttons

- Non-illuminated push buttons in mono-block style.
- Complete units available in various colours and contact configurations.
- Robust design in green, red, blue and amber and black with modern silver coloured bezel.
- Simple installation via standard lock nut.
- Spring return head
- Mechanical life more than 1 million uses

**IP65
RATED**

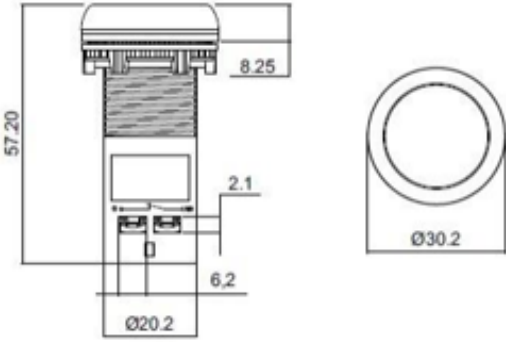

| Stock No. | Style | Colour | Contact |
|-----------|-------|--------|-----------|
| 145-0616 | Flush | Green | 2NO |
| 145-0617 | Flush | Yellow | 2NO |
| 145-0618 | Flush | Black | 2NO |
| 145-0619 | Flush | Blue | 2NO |
| 145-0621 | Flush | Red | 2NC |
| 145-0607 | Flush | Green | 1NO |
| 145-0609 | Flush | Red | 1NC |
| 145-0610 | Flush | Amber | 1NO |
| 145-0612 | Flush | Black | 1NO |
| 145-0613 | Flush | Blue | 1NO |
| 145-0611 | Flush | Red | 1NO + 1NC |
| 145-0615 | Flush | Green | 1NO + 1NC |

LED Indicators

- LED Indicators with multi-chip technology providing a bright and even colour with lower power consumption
- 22mm dia cutout with a choice of 12/24/230V operation - AC or DC
- Front panel protected to IP40 and have an operational life of 30,000 hours
- Built in Test Circuit allows remote illumination of all indicators in a panel for diagnostic purposes

**IP65
RATED**

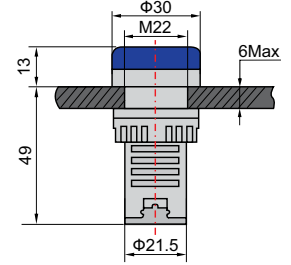

| Stock No. | Colour | Voltage |
|-----------|--------|---------|
| 909-2496 | Blue | 110V |
| 909-2483 | Blue | 12V |
| 909-2499 | Blue | 230V |
| 909-2487 | Blue | 24V |
| 909-2506 | Green | 110V |
| 909-2493 | Green | 12V |
| 909-2500 | Green | 230V |
| 909-2503 | Green | 24V |
| 909-2516 | Red | 110V |
| 909-2519 | Red | 12V |
| 909-2525 | Red | 230V |
| 909-2512 | Red | 24V |
| 909-2531 | White | 110V |
| 909-2528 | White | 12V |
| 909-2534 | White | 230V |
| 909-2522 | White | 24V |
| 909-2540 | Yellow | 110V |
| 909-2538 | Yellow | 12V |
| 909-2544 | Yellow | 230V |
| 909-2547 | Yellow | 24V |

Key Switches

- Non-illuminated key switches in mono-block style. Complete units available in various colours and contact configurations. Robust design with modern silver coloured bezel. Simple installation via standard lock nut.
- Spring return or latching head
- Complete units
- Mechanical life more than 1 million uses
- All key switches from the RS PRO plastic modular series are supplied with alike keys
- Keys are removable at 0 - position

IP65 RATED

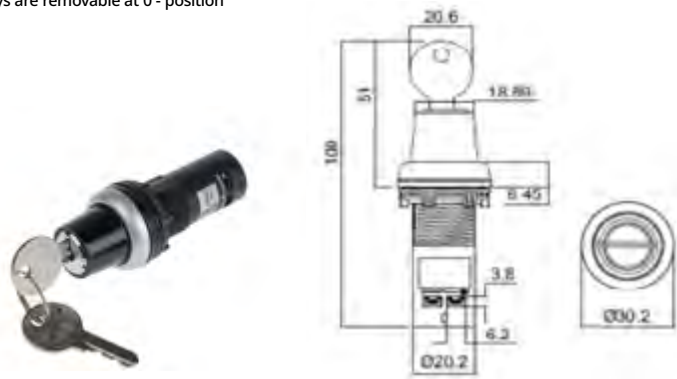

Selector Switches

- Non-illuminated selector switches in mono-block style.
- Complete units available in various positions and contact configurations.
- Robust design with modern silver coloured bezel.
- Simple installation via standard lock nut.
- Spring return head
- Mechanical life more than 1 million uses

IP65 RATED



| Stock No. | Contact | Positions | Spring Return | Actuation Diagram |
|-----------|-----------|------------|---------------------|-------------------|
| 145-0626 | 1NO + 1NC | 2 Position | None | |
| 145-0627 | 1NO + 1NC | 2 Position | From Right | |
| 145-0628 | 1NO + 1NC | 3 Position | None | |
| 145-0629 | 1NO + 1NC | 3 Position | From Left and Right | |

| Stock No. | Contact | Positions | Spring Return | Actuation Diagram |
|-----------|-----------|------------|---------------------|-------------------|
| 145-0622 | 1NO + 1NC | 2 Position | None | |
| 145-0623 | 1NO + 1NC | 2 Position | From Right | |
| 145-0624 | 1NO + 1NC | 3 Position | None | |
| 145-0625 | 1NO + 1NC | 3 Position | From Left and Right | |

LED Indicators with Sounder

- LED Indicators with multi-chip technology providing a bright and even colour with lower power consumption
- 22mm dia cutout with a choice of 12/24/230V operation - AC or DC
- Combined audible and visual warning via sounder output - 80dB
- IP30 front panel protection

IP30 RATED



Pulsing Sounder

- 22mm pulsing audible signal, perfect for use in alarm circuits
- IP30 front panel protection
- All voltages offer AC or DC supply operation

IP30 RATED



| Stock No. | Colour | Voltage |
|-----------|--------|---------|
| 909-2550 | Red | 110V |
| 909-2553 | Red | 12V |
| 909-2569 | Red | 230V |
| 909-2556 | Red | 24V |

| Stock No. | Colour | Voltage |
|-----------|--------|----------|
| 909-2562 | Black | 12Vac/dc |
| 909-2566 | Black | 24Vac/dc |
| 909-2575 | Black | 110/120V |
| 909-2578 | Black | 230Vac |

Flush Push Button Heads

- Non-illuminated flush and raised push button heads for use with the RS PRO modular metal push button series.
- Robust designs in a variety of colours with modern metal bezel.
- Simple installation via clamp screws.
- 22mm mounting diameter
- 29mm head diameter
- Contact block mounting collar included
- Spring return head

**IP65
RATED**



| Stock No. | Style | Colour |
|-----------|--------|--------|
| 205-2353 | Flush | Blue |
| 205-2357 | Flush | Yellow |
| 205-2354 | Flush | Red |
| 205-2355 | Flush | Green |
| 205-2358 | Flush | Black |
| 205-2359 | Flush | White |
| 205-2360 | Raised | Red |
| 205-2361 | Raised | Green |

Selector Switch Heads

- 2 or 3 position selector switch heads for use with the RS PRO modular metal push button series.
- Robust design with modern aesthetics delivered via metal bezel.
- Simple installation via clamp screws.
- Head Diameter 29mm
- Latching and Spring return head options
- Contact block mounting collar included
- Mechanical life more than 1 million uses

**IP65
RATED**



| Stock No. | Colour | Lever | Positions | Spring Return | Actuation Diagram |
|-----------|--------|-------|------------|------------------|-------------------|
| 205-2369 | Black | | 2 Position | Return to Centre | |
| 205-2370 | Black | Long | 2 Position | Return to Centre | |
| 205-2376 | Black | | 3 Position | Return to Centre | |
| 205-2377 | Black | Long | 3 Position | Return to Centre | |
| 205-2367 | Black | | 2 Position | Stay Put | |
| 205-2368 | Black | Long | 2 Position | Stay Put | |
| 205-2374 | Black | | 3 Position | Stay Put | |
| 205-2375 | Black | Long | 3 Position | Stay Put | |

Key Switch Heads

- 2 or 3 position key switch heads for use with the RS PRO modular metal push button series.
- Robust design with modern aesthetics delivered via metal bezel.
- Simple installation via clamp screws.
- Head Diameter 29mm
- Latching and Spring return head options
- Contact block mounting collar included
- All key switches from the RS PRO plastic modular series are supplied with alike keys



| Stock No. | Positions | Cut Out Ø | Key Removal | Actuation Diagram | Spring Return |
|-----------|------------|-----------|----------------------|-------------------|------------------------|
| 205-2372 | 2 Position | 22.5mm | Left Only | | Latching |
| 205-2371 | 2 Position | 22.5mm | Left & Right | | Latching |
| 205-2380 | 3 Position | 22.5mm | Centre Only | | Latching |
| 205-2379 | 3 Position | 22.5mm | Left, Right & Centre | | Latching |
| 205-2373 | 2 Position | 22.5mm | Left Only | | Return Right to Centre |
| 205-2381 | 2 Position | 22.5mm | Centre Only | | Return to Centre |

Contact Blocks

- Screw terminal connection
- Stackable design for contact blocks (max 6)
- Mechanical life more than 1 million uses
- 500V AC / 10A Switching Capacity
- Spring return actuation



| Stock No. | Contacts | Terminal | Actuation | Switching Capacity | Mounting Type |
|-----------|----------|----------|---------------|--------------------|---------------|
| 205-2382 | NO | Screw | Spring Return | 500V AC / 10A | Screw |
| 205-2383 | NC | Screw | Spring Return | 500V AC / 10A | Screw |

Legend Plates

- Pack of 5
- 30mm x 40mm Size
- Compatible with Ø 22.5mm Control or Signalling Unit

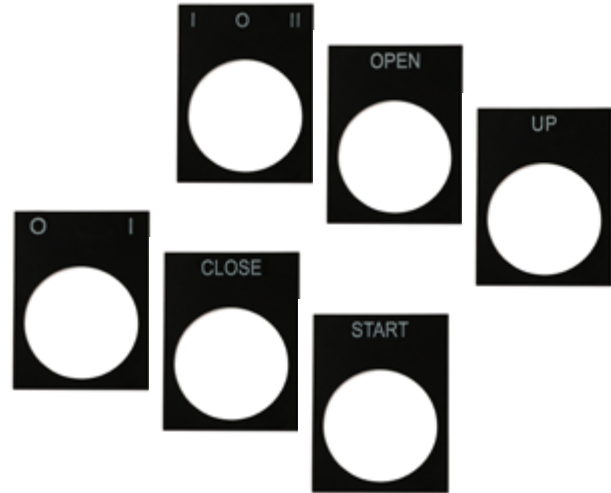

| Stock No. | Print | Pack Size |
|-----------|-----------|-----------|
| 175-3954 | 0-I | 5 |
| 175-3955 | CLOSE | 5 |
| 175-3956 | DOWN | 5 |
| 175-3958 | FORWARD | 5 |
| 175-3959 | I-O-II | 5 |
| 175-3960 | OFF, - ON | 5 |
| 175-3961 | OPEN | 5 |
| 175-3962 | RESET | 5 |
| 175-3964 | REVERSE | 5 |
| 175-3965 | START | 5 |
| 175-3966 | STOP | 5 |
| 175-3967 | UP | 5 |

Push Button Enclosures - Plastic

- Made with durable ABS plastic
- IP66 protection
- 22.5 mm cutout diameter for push button
- Supplied with 4 plastic screws

**IP66
RATED**



- 182-8655 1 Hole, Grey
- 182-8656 2 Hole, Grey
- 182-8657 3 Hole, Grey
- 182-8658 4 Hole, Grey

Push Button Enclosure - Diecast Aluminum

- Single hole empty control station
- Die cast aluminium
- Yellow lid on dark grey base
- House 22.5 mm push buttons and selector switches
- Robust
- IP65 Rated

**IP65
RATED**



- 136-8582 1 Hole, Yellow
- 136-8581 1 Hole, Yellow, with Shroud

Emergency Stop Mushroom Head Push Button Complete Unit

- Palm and Foot E-Stop device
- Large and distinctive pushbutton of visibility (Red)
- Emergency stop pushbutton- Pull to release
- Two M20 cable entries

IP65 RATED



242-0840 1 NO + 1 NC

Signal Tower

- Pre-configured RS PRO LED beacon tower is a robust unit that is easy to install using 4 mounting screws and a 2-pole cable at the base and steady LED light output
- Made from durable Polycarbonate, the tower unit is self-extinguishing, offers superior protection against UV and is impact-resistant, ideal for harsh environments

IP65 RATED



199-9760 3 Lights, 24 V,

199-9758 2 Lights, 24 V, 36 mm (Diameter) x 165 mm (Height)

E-STOP Push Button

- Yellow & Grey enclosure for greater visibility
- Red mushroom head push button with clear marked direction visibility
- IP65 rating offers reliability in harsh environments
- Two M20 knockout holes
- Twist release
- Screw with captive cable clamp

IP65 RATED



242-0842 1NC Contacts

242-0843 1NC + 1NO Contacts

242-0845 2NC Contacts

LED Warning Light Modules

- Dual voltage LED warning light modules - 3 x LED light
- Compatible with both 12V and 24V power systems and combine low power consumption with 15 flash patterns.
- Multiple units can be linked for synchronised / alternate flash

IP67 RATED



907-5955 Amber

907-5959 Red

907-5968 Green

Internal Piezo Buzzer

- Designed to be versatile, these internal buzzers operate at a wide voltage range and deliver crisp sound from a compact package.



LED Beacons

- Screw mounted beacon, sealed for life against dust and moisture ingress
- 4 flash patterns
- 77mm dia x 95mm high



907-5961 Amber, Low Prof, 10-100Vdc

907-5977 Amber, Low Prof, 110-230Vac

907-5974 Green, Low Prof, 10-100Vdc

907-5965 Red, Low Prof, 10-100Vdc

907-5971 Red, Low Prof, 110-230Vac

907-5980 Amber, 10-100Vdc

907-5996 Amber, 110-230Vac

907-5983 Red, 10-100Vdc

907-5999 Red, 110-230Vac

| Stock No. | Tone Type | Supply Voltage | Sound Level | Frequency | Pack Size |
|-----------|------------|-----------------|-------------|---------------|-----------|
| 622-1562 | Slow pulse | 60 to 250Vac/dc | 82dB | 2.3 to 3.3KHz | 1 |
| 535-8483 | Continuous | 4 to 28Vdc | 98dB | 2.3 to 3.3KHz | 1 |
| 457-043 | Fast Pulse | 60 to 220Vac/dc | 91dB | 2.3 to 3.3KHz | 5 |
| 535-8360 | Fast Pulse | 6 to 28Vdc | 80dB | 2.3 to 3.3KHz | 1 |
| 535-8499 | Slow Pulse | 6 to 28Vdc | 80dB | 2.3 to 3.3KHz | 1 |
| 622-1483 | Slow Pulse | 6 to 28Vdc | 85dB | 2.3 to 3.3KHz | 1 |

Sealed Miniature Toggle Switches

- These full sealed switches feature a double shell case for added mechanical strength and high electrical insulation
- The switches have a two 'O' ring frontal seals that maintain the seal during operation
- The rear of the switch is also fully sealed allowing full protection from flowing water
- The contacts are suitable for both low level switching (10 mA 50 mV - 10 µA, 5 V dc minimum) and power applications (3 A @ 250 V ac)



IP67 RATED

| | |
|----------|-----------------------|
| 820-0504 | 12mm on-on |
| 820-0508 | 12mm on-momentary |
| 820-0517 | 12mm on-off-on |
| 820-0510 | 12mm (on)-off-(on) |
| 820-0514 | 12mm on-off-momentary |
| 820-0523 | 12mm on-on-on |
| 820-0526 | 12mm (off)-on-(off) |
| 820-0542 | 12mm on-on |
| 820-0539 | 12mm on-on |
| 820-0551 | 12mm on-momentary |
| 820-0532 | 12mm on-momentary |
| 820-0554 | 12mm on-off-on |
| 820-0558 | 12mm (on)-off-(on) |

21x15mm Miniature Rocker Switches

- Miniature SPST rocker switches, available in a wide variety of markings and colour options
- Panel cut out 19.2 x 13 mm
- Fitted with 4.8 mm blade style terminals (except stock no. 419-726 which has solder tag terminals)
- Snap-in mounting, easy to install into panel
- Nylon Housing to UL 94V-2 with silver plated brass terminals



| | |
|---------|--|
| 419-726 | SPNO Black, on-off |
| 419-732 | SPST Black, on-off-on |
| 419-744 | SPNO Black, 0/I marking, on-off |
| 419-748 | SPNO Red, 0/I marking, on-off |
| 419-750 | SPST Red, 0/I marking, on-off |
| 419-754 | SPST Black, 0/I marking, on-off |
| 419-798 | SPNO White/black, 0/I marking, on-off |
| 419-794 | SPNO Red/black, 0/I marking, on-off |
| 419-782 | SPDT Red Illum.,220-250V neon, on-off-on |
| 419-788 | SPDT Green Illum.,220-250V neon, on-off-on |

C/O Microswitch

- Pre-wired fully sealed single pole changeover switch
- Glass fibre reinforced nylon enclosure, fully sealed to IP67
- Pre-wired lead length: 0.5 m
- 5 A @ 250 V ac

IP67 RATED



| | |
|----------|-----------------------|
| 797-2542 | Plunger actuator |
| 797-2549 | Short roller actuator |

Ultra Miniature Microswitch

- Actuator types supplied as a basic switch plus unfitted actuator kit with fixing hardware
- SPDT silver-plated contacts
- Contact Rating: 7 A (Resistive); 4 A (Inductive), 250 V ac; 28 V dc
- Operating temperature range: -54 to +121°C



| | |
|---------|-------------|
| 333-316 | Lever |
| 333-300 | Leaf |
| 333-322 | Roller leaf |

Professional Grade Toggle Switches

- Slow make-and-break action switches ideal for low voltage or current applications, such as audio or video signals
- Chrome-plated lever
- Solder bucket terminals
- 0.4 VA max load
- Glass filled polyester case



| | |
|---------|--------------------------------------|
| 316-995 | 4P on-on silver,6A |
| 316-973 | 1P on-on silver,6A |
| 317-572 | 1P on-on Au contact locklever switch |
| 317-005 | 1P on-off-on slv6A |
| 316-989 | 2P on-on silver,6A |
| 317-588 | 2P on-on Au contact lever switch,6A |
| 344-710 | 2P on-on-on silver |
| 317-178 | 2P on-off-on,6A |

Metal Housed Micro Switch

- Metal housed 15 A 250 V rated, snap action micro switches
- Single pole changeover contacts, NO/NC
- Insulated terminal cover plate
- Rated to 1,000,000 operations



| | |
|----------|-------------------------|
| 797-2501 | Plunger, IP54 |
| 797-2498 | Lever roller, IP54 |
| 797-2494 | Roller plunger, IP40 |
| 797-2508 | Plunger Pre-wired, IP54 |

Series S Microswitch

- Heavy duty actuator spring with adjustable roller
- Synthetic rubber plunger, zinc alloy housing
- Insulated terminal cover plate
- Rated to 1,000,000 operations



| | |
|----------|-----------------|
| 804-6186 | 15 A @ 250 V ac |
|----------|-----------------|

PROGRAMMABLE CONTROL DEVICES

Make your control panel smart and keep your production line well-connected with RS PRO. RS PRO's choice of HMI displays, featuring larger monitors, smoother touchscreens and high-powered processors.

Touch Screen HMI Displays

- High-performing HMI display used to monitor machines, perform tasks and visualise operational status



| | |
|-----------------|---|
| 215-6604 | 7 in screen, USB interface |
| 215-6605 | 7 in screen, USB, Ethernet interface |
| 215-6606 | 10.2 in screen, USB, Ethernet interface |

3 Digit, 3 Line Digital Multi-function Meters

- 3 Digit digital (96x96mm) panel meters offering measurement of key electrical parameters in 3 phase 4-wire, 3 phase three wire and single phase networks
- This single multi-function meter can replace multiple analogue panel meters
- Measurements include AC voltage, AC current, Frequency and more
- True RMS measurement
- Onsite programmable



| | |
|-----------------|--------------------------|
| 136-5377 | 3Ph, V A F |
| 136-5378 | 3Ph, V A F + Limit Relay |

4 Digit, 3 Line Digital Multi-function Meters

- 4 digit, multi line, LED multi-function, 96x96mm, digital meters offering a choice of parameter measurement in a single unit
- Measurements include AC voltage, AC current, Frequency, energy and more
- Limit switch relay output option
- User selectable CT secondary 1A/5A and PT secondary from 100 VLL to 500 VLL
- User selectable 3 ph 3 wire/3 ph 3 wire/ single phase network
- Wide auxiliary power supply which can accept any input between 40 V-300 V ac/dc or 12 V-48 V dc
- Storage of MIN/MAX values
- Measurement and display of RPM, run hours, on hours and No. of interrupts



| | |
|-----------------|------------------------------------|
| 136-5380 | 3Ph, V A F |
| 136-5379 | 3Ph, V A F + Limit Relay |
| 136-5383 | 3Ph, V A F & Energy + RS485 |
| 136-5384 | 3Ph, V A F, Energy + Limit & RS485 |

Programmable Counter

- 6 Digit LED display
- 24V & 230V options available
- NEMA 4X Protection (IP65 frontal, IP20 rear)
- SPST relay output rated at 5A @ 250V (Resistive Load)
- Supports NPN/PNP operation
- Inputs for capacitive & proximity sensors and an encoder
- Manual & automatic reset options



| | |
|-----------------|-------------|
| 808-6605 | 48x48, 230V |
| 808-6614 | 48x48, 24V |
| 808-6627 | 96x48, 230V |
| 808-6636 | 96x48, 24V |

Digital Time Switch

- Daily/weekly/pulse switching (depending on model)
- 3 lines text LCD display and DIN Rail mounting
- 25 On/Off programs
- LED indication of relay status
- 12/24 h display formats
- 6 years battery reserve
- Simple reset and manual override
- 110-240 V ac supply voltage
- Settable DST & keypad lock feature
- IP20 (terminals), IP40 (enclosure) protection



| | |
|-----------------|-------------------------------|
| 896-6876 | 110-240Vac 1 Channel (by sec) |
| 896-6891 | 12Vdc 1 Channel |
| 896-6885 | 10-240Vac 1 Channel (by min) |

Multi-function Digital Timer

- 35x77mm panel mounting timer with Start/stop/reset control from front panel
- 9 timer modes, fully adjustable and easy to install
- Timing in seconds, minutes and hours on a bright LED display
- Two timed control outputs



| | |
|-----------------|-----------|
| 124-1077 | 230V ac |
| 124-1078 | 24V ac/dc |

Logic Modules

- Compact, Low cost, logic modules from RS Pro - easy to program via USB with FREE software
- Basic logic controller is available with or without LCD display and offers 8 DI + 4 Relay Output
- Two of the inputs can be used as analogue (917-6370 & 917-6377)
- 250 lines of ladder programming - including timers, counters, Boolean, timeswitch functions and comparison functions
- RS Pro Logic Module software is available as a free download via the following link:
- http://download.designspark.info/RS_Logic_Module.zip



| | |
|-----------------|---|
| 917-6361 | Logic Module w. Display 8I/4O 110-240V |
| 917-6370 | Logic Module w. Display 8I/4O 12-24V |
| 917-6373 | Logic Module w/o Display 8I/4O 110-240V |
| 917-6377 | Logic Module w/o Display 8I/4O 12-24V |
| 917-6386 | Expansion Module 8I/4O 110-240Vac |
| 917-6389 | Expansion Module 8I/4O 12-24Vdc |
| 917-6383 | RS485 Comms module 110-240Vac |
| 917-6392 | RS485 Comms module 12-24Vdc |
| 917-6395 | USB Programming Cable |
| 917-6399 | Memory Module |

Digital Hour Meter

- Digital hour meters come in a small variety of bezels and a wide range of supply voltage.
- 6-digit (5 mm) LCD display
- Panel mounting
- Wide range of supply voltage
- Remote reset
- Available in 3 different bezels (depending on model)
- Lower power consumption



| | |
|-----------------|-----------------------------------|
| 896-6955 | Round Face 12-48Vac/dc |
| 896-6977 | Rectangular Face 12-48Vac/dc |
| 896-6986 | Rectangular Face 24x48mm 10-80Vdc |
| 896-6973 | 23mm x 36.5mm 85-265Vac |
| 896-6967 | 23mm x 45.5mm 85-265Vac |

DIN Rail Temperature Controller

- Text/Icon matrix display
- Quick setup menu with main configuration parameters
- 3 button operation along with 3 status LEDs



| Stock No. | Supply Voltage | Number of Outputs | Communications |
|-----------|----------------|-----------------------------------|----------------|
| 144-8680 | 110-240V ac | 1 x C/O Relay, 1 x Relay | Not fitted |
| 144-8681 | 110-240V ac | 1 x C/O Relay, 1 x SSR, 1 x Relay | Not fitted |
| 144-8682 | 110-240V ac | 1 x C/O Relay, 1 x SSR, 1 x Relay | RS485 Comms |
| 144-8677 | 24V ac/dc | 1 x C/O Relay, 1 x Relay | Not fitted |
| 144-8678 | 24V ac/dc | 1 x C/O Relay, 1 x SSR, 1 x Relay | Not fitted |
| 144-8679 | 24V ac/dc | 1 x C/O Relay, 1 x SSR, 1 x Relay | RS485 Comms |

PID Digital Thermostat

- 35x77mm size.
- Heating or cooling applications
- Thermocouple or PT100 inputs
- Two outputs for control and alarms
- ON/OFF or PID control
- On sensor failure, manual control can be selected.
- Sensor input offset setting
- Two setpoint - selectable from front panel.
- Selectable thermocouple types or PT100 input. (Specify at order).
- PID Autotune
- Soft-Start feature.
- Two outputs - Relay (control or alarm) and SSR (control)
- CE marked



| Stock No. | Input Type | Number of Inputs | Supply Voltage | Number of Outputs | Dimensions |
|-----------|--------------|------------------|----------------|--------------------|------------|
| 124-1058 | PT100 | 1 | 230 V ac | 1 x relay, 1 x SSR | 35x77mm |
| 124-1059 | Thermocouple | 1 | 230 V ac | 1 x relay, 1 x SSR | 35x77mm |
| 124-1060 | Thermocouple | 1 | 24 V ac/dc | 1 x relay, 1 x SSR | 35x77mm |

Digital Thermostat

- Ingress Protection (IP) ratings of IP20 and IP65
- Compact in size (35x77mm) making it easy to install
- Panel depth of 61 mm
- NTC (negative temperature coefficient) sensor, J Type Thermocouple & PT100 input options available



| Stock No. | Input Type | Number of Inputs | Supply Voltage | Number of Outputs | Dimensions |
|-----------|------------|------------------|----------------|-------------------|------------|
| 124-1045 | NTC | 1 | 230 V ac | 1 | 35x77mm |
| 124-1046 | NTC | 1 | 24 V ac/dc | 1 | 35x77mm |
| 124-1047 | NTC | 1 | 230 V ac | 2 | 35x77mm |
| 124-1048 | NTC | 1 | 24 V ac/dc | 2 | 35x77mm |
| 124-1049 | NTC | 2 | 230 V ac | 3 | 35x77mm |
| 124-1050 | NTC | 2 | 24V ac/dc | 3 | 35x77mm |

ON/OFF Thermostat - J Thermocouple

- Ingress Protection (IP) ratings of IP20 and IP65
- Compact in size (35x77mm) making it easy to install
- Panel depth of 61 mm
- NTC (negative temperature coefficient) sensor, J Type Thermocouple & PT100 input options available



| Stock No. | Input Type | Number of Inputs | Supply Voltage | Number of Outputs | Dimensions |
|-----------|---------------------|------------------|----------------|-------------------|------------|
| 124-1051 | J Type Thermocouple | 1 | 230 V ac | 1 | 35x77mm |
| 124-1052 | J Type Thermocouple | 1 | 24V ac/dc | 1 | 35x77mm |

Digital Thermostat

- High quality digital controller offers a single NTC probe input.
- Featuring built in On/Off or pulse output status, it can also be used as an alarm unit.
- This controller is Easy to configure and install, with a large clear display giving good visibility alongside a compact design.
- Ideal for use with NTC sensors.
- 35x77mm size



| Stock No. | Input Type | Number of Inputs | Supply Voltage | Number of Outputs |
|-----------|------------|------------------|----------------|-------------------|
| 124-1053 | NTC | 1 | 24 V ac/dc | 1 |
| 124-1054 | NTC | 1 | 230 V ac | 1 |
| 124-1055 | NTC | 1 | 24 V ac/dc | 2 |
| 124-1056 | NTC | 1 | 230 V ac | 2 |

DIN Rail Thermostat

- Designed for use with NTC sensors
- Easy to configure and use, along with a large clear display that gives greater visibility
- Compact design which makes it fast to install in various application fields



| Stock No. | Input Type | Number of Inputs | Supply Voltage | Number of Outputs |
|-----------|------------|------------------|----------------|-------------------|
| 124-1057 | NTC | 1 | 230 V ac | 1 |

PID Temperature Controller

- Designed to provide temperature control in an easy to install, fast to program device
- The temperature is displayed on a large, highly improved LED display
- Front Fascia 1/16 DIN = 48 x 48mm
- 124-1083 Terminal cover fits onto 96 x 48 mm and 48 x 48 mm
- Depth 67mm



| Stock No. | Front Fascia Size | Supply Voltage | Number of Outputs |
|-----------|-------------------|----------------|--------------------|
| 124-1061 | 96 x 48mm | 24V ac/dc | 1 x SSR, 2 x Relay |
| 124-1062 | 96 x 48mm | 24V ac/dc | 3 x Relay |
| 124-1063 | 96 x 48mm | 110-240V ac | 1 x SSR 2 x Relay |
| 124-1064 | 96 x 48mm | 110-240V ac | 3 x Relay |
| 124-1065 | 48 x 48 mm | 110-240V ac | 2 x Relay |
| 124-1066 | 48 x 48 mm | 110-240V ac | 1 x SSR, 1 x Relay |
| 124-1070 | 48 x 48 mm | 110-240V ac | 2 x SSR 1 x Relay |
| 124-1071 | 48 x 48 mm | 110-240V ac | 1 x SSR 2 x Relay |
| 124-1072 | 48 x 48 mm | 110-240V ac | 3 x Relay |
| 124-1067 | 48 x 48 mm | 24V ac/dc | 2 x SSR 1 x Relay |
| 124-1068 | 48 x 48 mm | 24V ac/dc | 1 x SSR 2 x Relay |
| 124-1069 | 48 x 48 mm | 24V ac/dc | 3 x Relay |

PROCESS CONTROL & PROTECTION

From DIN Rail to Embedded Switch Mode Power Supplies, up to Power Monitors - RS PRO covers your every need.

DIN Rail Power Supplies

- Adjustable output voltage power supplies for DIN rail mounting.
- These DIN rail mount power supplies are available with a range of power ratings from 15 W to 240 W and accept single-phase AC input for conversion into a single DC output of either 12V, 15V, 24V or 48V DC.



Image for illustrative purposes only

| Stock No. | Input Electrical Phase | Input Voltage | Output Voltage | Output Voltage Adjustment Range | Output Current | Power Rating | Dimensions W x H x D |
|-----------|------------------------|---------------|----------------|---------------------------------|----------------|--------------|----------------------|
| 136-8301 | Single Phase | 230V | 12V DC | 11.6 - 12.3V | 1.2A | 15W | 22.5 x 95 x 108mm |
| 136-8302 | Single Phase | 230V | 15V DC | 13 - 16V | 15V | 15W | 22.5 x 95 x 108mm |
| 136-8303 | Single Phase | 230V | 24V DC | 23.5 - 24.5V | 650mA | 15W | 22.5 x 95 x 108mm |
| 136-8304 | Single Phase | 230V | 5V DC | 4.5 - 5.3V | 5A | 30W | 36 x 95 x 108mm |
| 136-8305 | Single Phase | 230V | 12V DC | 11.6 - 12.3V | 2.5A | 30W | 36 x 95 x 108mm |
| 136-8306 | Single Phase | 230V | 15V DC | 13 - 16V | 2.0A | 30W | 36 x 95 x 108mm |
| 136-8308 | Single Phase | 230V | 24V DC | 23.5 - 24.5V | 1.3A | 30W | 36 x 95 x 108mm |
| 136-8309 | Single Phase | 230V | 12V DC | 11.6 - 12.3V | 4.2A | 50W | 30 x 130 x 125mm |
| 136-8310 | Single Phase | 230V | 24V DC | 23.5 - 24.5V | 2.2A | 50W | 30 x 130 x 125mm |
| 136-8311 | Single Phase | 230V | 48V DC | 47.5 - 48.3V | 1.1A | 50W | 30 x 130 x 125mm |
| 136-8312 | Single Phase | 230V | 12V DC | 11 - 14V | 5A | 70W | 33 x 130 x 125mm |
| 136-8315 | Single Phase | 230V | 24V DC | 23 - 28V | 3A | 70W | 33 x 130 x 125mm |
| 136-8316 | Single Phase | 230V | 48V DC | 47 - 55V | 1.5A | 70W | 33 x 130 x 125mm |
| 136-8317 | Single Phase | 230V | 12V DC | 11 - 14V | 8A | 120W | 40 x 130 x 125mm |
| 136-8319 | Single Phase | 230V | 24V DC | 23 - 28V | 5A | 120W | 40 x 130 x 125mm |
| 136-8320 | Single Phase | 230V | 48V DC | 47 - 55V | 2.5A | 120W | 40 x 130 x 125mm |
| 136-8321 | Single Phase | 230V | 24V DC | 22 - 28V | 10A | 240W | 60 x 130 x 125mm |
| 136-8322 | Single Phase | 230V | 48V DC | 45 - 55V | 5A | 240W | 60 x 130 x 125mm |

Power Line Filter

- Significantly reduces the amount of conducted frequencies between your equipment and the connecting power line.
- Rated currents up to 10A



| Stock No. | Maximum Voltage Rating | Maximum Current Rating | Number of Phases | Mounting Type |
|-----------|------------------------|------------------------|------------------|---------------|
| 237-8738 | 300/520 V ac | 8A | 3 | Chassis Mount |
| 237-8739 | 520 V ac | 8A | 3 | Chassis Mount |
| 237-8741 | 520 V ac | 20A | 3 | Chassis Mount |
| 237-8742 | 300/520 V ac | 25A | 3 | Chassis Mount |
| 237-8744 | 520 V ac | 25A | 3 | Chassis Mount |
| 237-8745 | 300/520 V ac | 30A | 3 | Chassis Mount |
| 237-8746 | 520 V ac | 30A | 3 | Chassis Mount |
| 237-8748 | 520 V ac | 150A | 3 | Chassis Mount |

RS510 Single Phase Inverters with Integral Filter

- These single phase inverter drives are suitable for a wide range of drive applications and come with a filter built-in
- Cost effective drive solution with wide range of programming capabilities and offering both V/F mode or Sensorless Vector operation
- Integral 5 digit operator panel and speed control potentiometer
- PID Process Control Loop
- 0-10VDC or 4-20mA Feedback & Control
- Built-in Modbus (RJ45 Interface)
- Digital Inputs



| | |
|----------|---------------|
| 122-3410 | 0.4KW, 0.50HP |
| 122-3411 | 0.75KW, 1HP |
| 122-3413 | 1.5KW, 2HP |
| 122-3414 | 2.2KW, 3HP |

Time Delay Relay - 17.5mm

- DIN Rail mounting
- Off delay timing function
- Integrated dual voltage
- LED indications for power and relay status
- Wide supply voltage range
- IP20 (terminals), IP40 (enclosure) protection



| | |
|-----------------|------------------------------|
| 896-6816 | On Delay, 110Vac & 24Vac/dc |
| 896-6810 | On Delay, 240Vac & 24Vac/dc |
| 896-6829 | Off Delay, 110Vac & 24Vac/dc |
| 896-6822 | Off Delay, 240Vac & 24Vac/dc |

10A Industrial Relay

- Protected by a clear polycarbonate cover
- DIN Rail or Surface Mounting
- Contact Material: Ag + Au Flashed
- Contact Rating is 10A
- Maximum temperature at rated coil voltage 65°C
- Dimensions: H 53mm, W 36mm, D 36mm



| Stock No. | Coil Voltage | Configuration | Coil Power | Terminal Type |
|----------------|--------------|---------------|------------|---------------|
| 348-829 | 24Vdc | 3PDT | 1.2W | Plug In |
| 349-282 | 115Vac | 3PDT | 2.75W | Through Hole |
| 348-813 | 230Vac | 3PDT | 2.75W | Plug In |
| 348-756 | 12Vdc | DPDT | 1.2W | Plug In |
| 348-784 | 24Vdc | DPDT | 1.2W | Plug In |
| 349-327 | 24Vac | DPDT | 2W | Plug In |
| 348-778 | 115Vac | DPDT | 2W | Plug In |
| 348-762 | 230Vac | DPDT | 2W | Through Hole |

LX Series Three Phase Monitoring Relays

- Adjustable under or under/over voltage monitoring relays with true RMS measurement
- Measures phase to phase voltages and detects incorrect phase sequence and phase loss
- Adjustment for voltage trip level & time delay
- 1 x SPDT relay output 8A & LED indication



| | |
|-----------------|------------------------|
| 102-6136 | Under voltage |
| 102-6137 | Under and over voltage |

Multi-function Time Delay Relay - 22.5mm

- Two multi-function timer relays offering a choice of common timing functions - including external trigger inputs
- 0.1s to 10/100h timing ranges
- Configured & set via flush knobs on front
- LED indication for runtime and relay status
- Full details of timer functions available online



| | |
|-----------------|---------------------------------------|
| 896-6850 | 5 Function timer, SPCO, 24-240Vac/dc |
| 896-6813 | 10 Function timer, SPCO, 12-240Vac/dc |

L Series Battery Voltage Alarm

- Adjustable battery under-voltage alarm monitoring relay for 9-28Vdc - ideal for 12v or 24v battery systems
- Adjustment for Time delay (from an Under voltage condition)



| | |
|-----------------|--|
| 102-6130 | 1 x SPDT relay output 8A with LED indication |
|-----------------|--|

LEDO - Single Function Timers

- Choice of On-delay or Off-delay timers with either a single or double pole output
- 7 selectable time ranges and fine adjustment of timing period
- Multi-voltage supply input (12-230Vac/dc)
- LED indication of supply & relay status



| | |
|-----------------|----------------------------------|
| 102-6124 | Delay on timer 1 x SPDT |
| 102-6128 | Delay off timer switch initiated |
| 102-6125 | Delay on timer 1 x DPDT |

LMMT - Multifunction Timers

- Multifunction timer LMMT in a 17.5mm DIN rail housing with 7 selectable functions and 7 time ranges
- Fine adjustment of selected time range
- LED indication of supply and relay status
- Multi-voltage supply input (12 - 230Vac/dc)



| | |
|-----------------|------|
| 102-6122 | SPDT |
| 102-6123 | DPDT |

L Series AC Under/Over Voltage Relay

- True R.M.S. monitoring of own supply and detects if the single phase supply exceeds the set Under or Over voltage trip levels
- Adjustment for Under voltage and Over voltage trip level
- Adjustment for Time delay (from an Under or Over voltage condition)
- 1 x SPDT relay output 8A with LED indication for supply status



| | |
|-----------------|---|
| 102-6131 | 1 Ph Under & Over Volt + Time Del Relay |
|-----------------|---|

RKL Miniature Power Relays

- 10A Industrial Plug-in Relay
- Gold plated contact
- Double side LED integrated in relay
- Lockable test button and inspection window
- Identification of coils through test button colour (AC red / DC blue)
- Conformity with RoHs directive



| Stock No. | Nominal Voltage | Poles | Switching Current | Options |
|-----------|-----------------|-------|-------------------|---------------------------|
| 121-7804 | 12Vdc | SPCO | 16A | LED + Test Button + Diode |
| 121-7807 | 24Vdc | SPCO | 16A | LED + Test Button |
| 121-7806 | 24Vac | SPCO | 16A | LED + Test Button + Diode |
| 121-7808 | 110Vac | SPCO | 16A | LED + Test Button |
| 121-7809 | 240Vac | SPCO | 16A | LED + Test Button |
| 121-7810 | 12Vdc | DPCO | 10A | LED + Test Button + Diode |
| 121-7811 | 24Vdc | DPCO | 10A | LED + Test Button + Diode |
| 121-7812 | 24Vac | DPCO | 10A | LED + Test Button |
| 121-7813 | 110Vac | DPCO | 10A | LED + Test Button |
| 121-7814 | 230Vac | DPCO | 10A | LED + Test Button |
| 121-7815 | 12Vdc | 3PCO | 10A | LED + Test Button + Diode |
| 121-7816 | 24Vdc | 3PCO | 10A | LED + Test Button + Diode |
| 121-7817 | 24Vac | 3PCO | 10A | LED + Test Button |
| 121-7818 | 110Vac | 3PCO | 10A | LED + Test Button |
| 121-7820 | 12Vdc | 4PCO | 10A | LED + Test Button + Diode |
| 121-7821 | 24Vdc | 4PCO | 10A | LED + Test Button + Diode |
| 121-7822 | 24Vac | 4PCO | 10A | LED + Test Button |
| 121-7824 | 230Vac | 4PCO | 10A | LED + Test Button |

RKL Relay Sockets

- DIN Rail mount relay sockets
- Screw connection
- Supplied with metal retaining clip



| | |
|----------|------|
| 121-7825 | DPCO |
| 121-7826 | 3PCO |
| 121-7827 | 4PCO |

RKE/RKF Relay Sockets

- DIN Rail mount relay sockets
- Screw connection
- Supplied with metal retaining clip



| | |
|----------|--------------|
| 121-7803 | Cage screw |
| 121-7802 | Rising screw |

RUB General Purpose Octal Relay

- 2 or 3 Pole 10A General Purpose Octal Relay
- Gold plated contact
- Double side LED integrated in relay
- Lockable test button and inspection window
- Identification of coils through test button colour (AC red / DC blue)
- Conformity with RoHs directive



| Stock No. | Nominal Voltage | Poles | Switching Current | Options |
|-----------|-----------------|-------|-------------------|---------------------------|
| 121-7828 | 12Vdc | DPCO | 10A | LED + Test Button + Diode |
| 121-7829 | 24Vdc | DPCO | 10A | LED + Test Button + Diode |
| 121-7830 | 24Vac | DPCO | 10A | LED + Test Button |
| 121-7831 | 110Vac | DPCO | 10A | LED + Test Button |
| 121-7832 | 240Vac | DPCO | 10A | LED + Test Button |
| 121-7837 | 110Vac | 3P | 10A | LED + Test Button |
| 121-7834 | 12Vdc | 3P | 10A | LED + Test Button + Diode |
| 121-7835 | 24Vdc | 3P | 10A | LED + Test Button + Diode |
| 121-7836 | 24Vac | 3P | 10A | LED + Test Button |
| 121-7838 | 240Vac | 3P | 10A | LED + Test Button |

RKF 4PCO Miniature Power Relay

- 4 Pole 6A Industrial Plug-in Relay
- Gold plated contact
- Double side LED integrated in relay
- Lockable test button and inspection window
- Identification of coils through test button colour (AC red / DC blue)
- Conformity with RoHs directive



| Stock No. | Nominal Voltage | Poles | Switching Current | Options |
|-----------|-----------------|-------|-------------------|---------------------------|
| 121-7797 | 12Vdc | 4PDT | 6A | LED + Test Button + Diode |
| 121-7798 | 24Vdc | 4P | 6A | LED + Test Button + Diode |
| 121-7799 | 24Vac | 4P | 6A | LED + Test Button |
| 121-7800 | 115Vac | 4P | 6A | LED + Test Button |
| 121-7801 | 240Vac | 4P | 6A | LED + Test Button |

RUB Relay Sockets

- DIN Rail mount relay sockets
- Screw connection
- Supplied with metal retaining clip



| | |
|----------|------------|
| 121-7839 | 8 pin 12A |
| 121-7841 | 8 pin 15A |
| 121-7840 | 11 pin 12A |
| 121-7842 | 11 pin 15A |

Motor Protection Switches

- Professional range of motor protection switches suitable for 3 phase motors up to 32A
- The switches incorporate an automatic switch-off at current and thermal and magnetic releases
- 35 mm DIN Rail, can be mounted in either vertical or horizontal
- MS32 Series



| | |
|----------|------------|
| 121-6858 | 25-32A |
| 121-6857 | 20-27A |
| 121-6856 | 17-23A |
| 121-6855 | 13-18A |
| 121-6854 | 9-14A |
| 121-6853 | 6.3-10A |
| 121-6852 | 4-6.3A |
| 121-6851 | 2.5-4A |
| 121-6850 | 1.6-2.5A |
| 121-6849 | 1-1.6A |
| 121-6848 | 0.63-1A |
| 121-6847 | 0.4-0.63A |
| 121-6846 | 0.25-0.4A |
| 121-6845 | 0.16-0.25A |

Shunt & Under-Voltage Release

- Shunt release to allow remove disconnect of starter from switch or PLC control
- Under-voltage release senses low motor supply voltage and disconnects starter
- MS32 Series



| | |
|----------|-------------------------------|
| 121-6871 | AR240 - Shunt release |
| 121-6869 | UR240 - Under voltage release |

Auxiliary Switches

- Auxiliary switches available with either 1 or 2 make/break contacts
- MS32 Series



121-6864 HS 20 - 2 NO Contacts

Enclosure

- IP41 and 55 rated enclosures for use with MS32 & MSB32 Motor Protection Circuit Breakers



**IP
RATED**

| | |
|----------|------------|
| 121-6860 | HO-55 IP55 |
| 121-6859 | HO-41 IP41 |

Auxiliary Contact Blocks

- Professional range of MS32 series auxiliary contact blocks
- The auxiliary contact blocks are available with either make or break contacts
- Available in horizontal or vertical fitment
- MS32 Series



| | |
|----------|------------------------------|
| 121-6867 | HRS10 - Trip indicating - NO |
| 121-6868 | HRS01 - Trip indicating - NC |
| 121-6866 | HSV01 - Auxiliary - NC |
| 121-6865 | HSV10 - Auxiliary - NO |

Enclosed Direct-on-line Motor Starters

- A range of enclosed Direct-On-Line motor starters which combine high performance and low cost
- Options with and without isolator and support for motors from 5.5 kW to 11 kW.
- Moulded plastic case providing IP65 ingress protection
- Compliant with standards IEC/EN 60947-1 and IEC/EN60947-4-1
- RF38 Overloads must be ordered separately to match motor current - See RS 685-1328



| | |
|-----------------|------------------------------|
| 725-5503 | 5.5kW 230VAC Coil |
| 725-5516 | 7.5kW 230VAC Coil |
| 725-5507 | 5.5kW 400VAC Coil |
| 725-5525 | 5.5kW 230VAC Coil + Isolator |
| 725-5529 | 5.5kW 400VAC Coil + Isolator |

Soft Starter

- This RS PRO soft starter is used to protect your motor when it starts and stops. It's designed to reduce torque, load and electrical surges when a motor kick-starts, improving the motor's lifespan.
- Made for use on single-phase motor types, this soft starter is well-suited to industrial automation processes to improve motor performance and efficiency.
- It has a DIN rail mount type.



209-6340 2.2 kW, 230 V ac, 1 Phase

Contactors

- Contactor Range for a variety of applications
- Three Coil actuation voltages to choose from
- Compact Design
- Contactors for switching AC-3 and AC-4 loads like asynchronous squirrel cage motors
- Different Coil voltages available
- Variety of auxiliaries including aux. Contact blocks; Surge suppressors, mechanical interlocks



| Stock No. | Nominal Current | Coil Voltage | Poles | Power Rating | Configuration |
|-----------------|-----------------|--------------|-------|--------------|---------------|
| 250-8810 | 15A | 24VDC | 3 | 7.5 kw | 1NC |
| 250-8802 | 15A | 24V 50/60Hz | 3 | 7.5 kw | 1NC |
| 250-8803 | 15A | 110V 50/60Hz | 3 | 7.5 kw | 1NC |
| 250-8804 | 15A | 230V 50/60Hz | 3 | 7.5 kw | 1NC |
| 250-8808 | 15A | 400V 50/60Hz | 3 | 7.5 kw | 1NC |

Thermal Overload Relay

- Overload Relays for protection of asynchronous squirrel cage motors
- Phase failure sensitivity and temperature compensation
- Reset pushbutton manual/auto
- Test/off pushbutton
- Integrated Aux. Contact
- Direct mount on Contactor



| Stock No. | Nominal Current Range | Aux Contacts |
|-----------------|-----------------------|--------------|
| 250-8879 | 0.4- 0.6 | 1 N/O 1N/C |
| 250-8880 | 0.6- 1 | 1 N/O 1N/C |
| 250-8881 | 1- 1.6 | 1 N/O 1N/C |
| 250-8882 | 1.6- 2.4 | 1 N/O 1N/C |
| 250-8883 | 2.4- 4 | 1 N/O 1N/C |
| 250-8884 | 4- 6 | 1 N/O 1N/C |
| 250-8885 | 6- 10 | 1 N/O 1N/C |
| 250-8886 | 9- 12 | 1 N/O 1N/C |
| 250-8888 | 12- 16 | 1 N/O 1N/C |

CONTROL CABINET WIRING

















Here are the most popular RS PRO parts for professional wiring of a control cabinet. Starting from bootlace ferrules to the right stripping and crimping tools, to cable markers, ties, heatshrinks and insulation tapes.

Tri-Rated Cable

- A tinned copper stranded conductor covered with a PVC sheath
- Suitable for internal connectors in equipment, motor starters and controllers as well as in switch control, relay and instrumentation panels for power and switchgear
- Operating Temperature up to 90°C for continuous use
- Voltage up to 600V AC
- The triple rating of BS6231 (UK), CSA TEW (Canada) and UL style 1015, 1028 or 1283 (America) makes it acceptable across many markets, for applications including high voltage wiring within electrical cabinets, switchgear wiring, rectifier equipment and motor starter circuitry.



| Stock No.  | Area | Colour | Reel length |
|---|---------------------|--|-------------|
| 180-5940 | 1.0 mm ² |  Orange | 100m |
| 180-5938 | 1.0 mm ² |  Red | 100m |
| 180-5943 | 1.0 mm ² |  Violet | 100m |
| 180-5936 | 1.0 mm ² |  Black | 100m |
| 180-5941 | 1.0 mm ² |  Blue | 100m |
| 180-5933 | 1.0 mm ² |  Brown | 100m |
| 180-5934 | 1.0 mm ² |  Green | 100m |
| 180-5939 | 1.0 mm ² |  Yellow | 100m |
| 180-5942 | 1.0 mm ² |  Grey | 100m |
| 811-1451 | 4.0 mm ² |  Brown | 100m |
| 811-1442 | 4.0 mm ² |  Black | 100m |
| 811-1436 | 4.0 mm ² |  Blue | 100m |
| 811-1448 | 4.0 mm ² |  Red | 100m |
| 811-1445 | 4.0 mm ² |  Green/yellow | 100m |
| 906-2713 | 4.0 mm ² |  Dark blue | 100m |
| 815-8627 | 4.0 mm ² |  Green | 100m |
| 811-1458 | 4.0 mm ² |  Grey | 100m |
| 815-8609 | 4.0 mm ² |  Light Blue | 100m |

| Stock No.  | Area | Colour | Reel length |
|---|---------------------|--|-------------|
| 815-8618 | 4.0 mm ² |  Orange | 100m |
| 815-8615 | 4.0 mm ² |  Violet | 100m |
| 815-8624 | 4.0 mm ² | White | 100m |
| 811-1454 | 4.0 mm ² |  Yellow | 100m |
| 811-1470 | 6.0mm ² |  Black | 100m |
| 811-1476 | 6.0mm ² |  Blue | 100m |
| 811-1489 | 6.0mm ² |  Brown | 100m |
| 906-2717 | 6.0mm ² |  Dark blue | 100m |
| 811-1473 | 6.0mm ² |  Green/yellow | 100m |
| 811-1464 | 6.0mm ² |  Grey | 100m |
| 815-8621 | 6.0mm ² |  Light blue | 100m |
| 815-8630 | 6.0mm ² | Orange | 100m |
| 811-1467 | 6.0mm ² |  Red | 100m |
| 815-8646 | 6.0mm ² | White | 100m |
| 811-1460 | 6.0mm ² |  Yellow | 100m |
| 628-5320 | 10.0mm ² |  Black | 100m |
| 628-5342 | 16.0mm ² |  Black | 100m |
| 815-8687 | 25.0mm ² |  Black | 100m |

Wire Cutters

- General purpose light duty wire cutters
- Ideal for educational environments
- Stainless steel version is fitted with moulded plastic grips and lightweight return springs
- Tool steel tools have PVC handle grips fitted with quick return coil springs



- 536-420** Semi-flush
- 536-379** Side
- 536-329** Side flush, Stainless Steel

Insulated wire strippers

- Ideal for working up to 1000Vac or 1500Vdc
- Suitable for single and multi-strand conductors
- DuoTech softgrip handles and chrome finish
- VDE Approved
- Overall length: 160mm



- 125-3075** 0.01 - 10 mm² Stripping Range

2 Piece Crimper & Stripper Tool Module

- Automatic wire and cable stripper with soft grip ergonomic handles and a self-adjustment mechanism for easy operation
- Also capable of crimping terminals
- Supplied with an automatic crimping pliers for use on insulated terminals
- Bright red foam helps identify missing parts quickly
- Foam tool modules are designed for regular easy removal from drawers



- 833-5966** 205mm Automatic Cable Stripper + 220mm Automatic Crimping Pliers

Self-adjusting wire strippers

- For use with round, oval and fat wire and cables
- Increased control and a smooth stripping action
- Adjustable sliding wire stop to preset exact stripping lengths
- Precision carbon steel laminated stripping blades



- 243-257** 0.2 - 6 mm² Stripping Range
- 382-2847** 0.08 - 2.5 mm² Stripping Range
- 243-263** 0.2 - 6 mm² Replacement Jaw
- 382-2853** 0.08 - 2.5 mm² Replacement Jaw

Mains Sheath Cable Stripper

- Perfect for 2-core and 3-core mains cables and leads
- Produces safe ring-of-cut for outer and inner insulation on all types of flexible cable
- Compact pocket-sized design with built-in cutter



- 663-437** 0.1 - 9mm Stripping Range

Automatic Wire Stripper

- Zinc alloy body and handle
- High carbon steel for the cutting and stripper knife blades.
- Spring steel for auto return tension spring.
- Suitable for use with PVC, silicone rubber and others
- Overall length: 165mm



- 663-617** 22 - 8AWG Stripping Range

Triple Action Cable Stripper

- Unique spiral-strip selector for hard-to-strip insulations
- Cuts through insulation up to 3mm thick
- Rotary, linear or spiral cut



- 262-0151** 4.5 - 29mm Stripping Range
- 262-0167** Replacement blades

Self Adhesive Wire Markers

- Stick to wires for permanent identification
- Suitable for different cable diameters
- Can be applied before or after the terminal has been connected



Cable Marking Kits - Slide-on

- 4500 high-quality slide on PVC cable markers
- Includes letters, numbers and symbols
- Supplied in a useful compartment box for easy transportation
- Special profile to fit a range of cable diameters
- Ideal for marking electrical wires and cables



| | |
|-----------------|-------------------|
| 812-1528 | 0 - 9, book |
| 812-1537 | 0 - 15, A - Z, +- |
| 812-1530 | 1 - 45, book |
| 812-1534 | 46 - 90, book |

| | |
|-----------------|---------------------------|
| 914-0602 | 0.75 - 3.5mm ² |
| 914-0605 | 3.5 - 8mm ² |
| 914-0592 | 2 - 8mm ² |

Cable Markers

- Material: UL approved Nylon 66, 94V-2



| Stock No. | Legend | For length | Colour | Pack |
|-----------------|-------------|---------------------------|--|------|
| 812-1231 | Numbers 0-9 | 0.5mm ² | Black, Brown, Green, Grey, Orange, Red, Violet, White and Yellow | 250 |
| 812-1203 | Numbers 0-9 | 0.5 to 1.5mm ² | Black, Brown, Green, Grey, Orange, Red, Violet, White and Yellow | 150 |
| 812-1219 | Numbers 0-9 | 1.5 to 2.5mm ² | Black, Brown, Green, Grey, Orange, Red, Violet, White and Yellow | 150 |
| 812-1225 | Numbers 0-9 | 4 to 6mm ² | Black, Brown, Green, Grey, Orange, Red, Violet, White and Yellow | 100 |
| 812-1240 | Letters A-M | 0.5mm ² | Yellow | 325 |
| 812-1243 | Letters N-Z | 0.5mm ² | Yellow | 325 |
| 812-1212 | Letters A-M | 0.5 to 1.5mm ² | Yellow | 195 |
| 812-1215 | Letters N-Z | 0.5 to 1.5mm ² | Yellow | 195 |
| 812-1221 | Letters A-M | 1.5 to 2.5mm ² | Yellow | 195 |
| 812-1228 | Letters N-Z | 1.5 to 2.5mm ² | Yellow | 195 |
| 812-1234 | Letters A-M | 4 to 6mm ² | Yellow | 130 |
| 812-1237 | Letters N-Z | 4 to 6mm ² | Yellow | 130 |

Heat Shrink Tubing Kits

- Mixed with different types of heat shrink tubing including harmonised colours.
- Contains 2:1 and 3:1 variants
- Sizes from 2.4 to 12.7mm
- Supplied in either a useful compartmented storage box or a slide out tray box that can be stacked or wall mounted
- Refill packs available on RS Online



- 397-679** 170 mixed piece kit, compartmented storage box
- 487-3852** 300 mixed piece kit, slide out tray box

Heatshrink Termination Kit

- Supplied with high quality Mil spec heatshrink sleeves in a range of colours to protect and insulate newly terminated cables.
- Contains heatshrink crimp splices, which after mechanical crimping, the use of a heat gun will shrink the adhesive outer to form a fully insulated and moisture proof seal.
- Black, Blue, Green/Yellow, Red, White Colours
- Sleeve diameters 3.2 mm, 4.8 mm, 6.4 mm, 9.5mm



- 562-646** 110mm sleeve length

PVC insulating tapes

- UV resistant
- Water resistant
- Flame retardant
- Self-extinguishing
- Easy to tear by hand
- Breakdown Voltage 8000V
- Compliant to EN 60454-3-1 Type 2



| Stock No. | Colour | Thickness | Length |
|-----------|--------|-----------|--------|
| 134-7321 | Black | 12 mm | 20 m |
| 134-7329 | Black | 38 mm | 20 m |
| 134-7319 | Black | 19 mm | 33 m |
| 134-7330 | Blue | 12 mm | 20 m |
| 134-7324 | Blue | 19 mm | 33 m |
| 134-7334 | Green | 12 mm | 20 m |
| 134-7331 | Green | 19 mm | 33 m |
| 134-7325 | Green | 12 mm | 20 m |
| 134-7328 | Green | 19 mm | 33 m |
| 134-7327 | Red | 12 mm | 20 m |
| 134-7323 | Red | 19 mm | 33 m |
| 134-7333 | White | 12 mm | 20 m |
| 134-7335 | White | 38 mm | 20 m |
| 134-7320 | White | 19 mm | 33 m |
| 134-7332 | Yellow | 12 mm | 20 m |
| 134-7326 | Yellow | 19 mm | 33 m |

Polyolefin Heatshrink Tubing 2:1

- High mechanical and electrical strength
- Corrosion and solvent resistant
- Bore sizes quoted are pre-shrink sizes (minimum) as supplied
- Supplied in lengths of 1.2 m



- 398-228** Black, 1.6mm
- 398-212** Black, 2.4mm
- 398-206** Black, 3.2mm
- 398-199** Black, 4.8mm
- 398-183** Black, 6.4mm
- 398-177** Black, 9.5mm
- 398-161** Black, 12.7mm
- 398-155** Black, 19.0mm
- 398-149** Black, 25.4mm
- 398-133** Black, 38.0mm
- 398-127** Black, 50.8mm
- 399-906** Clear, 2.4mm
- 399-928** Clear, 4.8mm
- 399-962** Clear, 19.0mm
- 399-978** Clear, 25.4mm
- 399-984** Clear, 38.0mm
- 399-990** Clear, 50.8mm
- 398-054** Yellow/green, 12.7mm
- 398-082** Yellow/green, 4.8mm

Heavy Duty Tubular Ring Terminals

- Made from copper with a tin plating
- Ideal for use on multistranded cables
- Available with a flared or a chamfered entry for ease of wire insertion



531-015 M5, 10mm², 25 Pack

531-021 M6, 10mm², 25 Pack

531-043 M6, 16mm², 10 Pack

531-065 M6, 25mm², 10 Pack

531-037 M8, 10mm², 25 Pack

531-059 M8, 16mm², 10 Pack

531-071 M8, 25mm², 10 Pack

241-4631 M8, 35mm², 10 Pack

531-885 M10, 35mm², 10 Pack

531-891 M10, 50mm², 10 Pack

531-914 M10, 70mm², 10 Pack

241-4647 M10, 95mm², 10 Pack

531-920 M12, 70mm², 10 Pack

241-4669 M12, 95mm², 10 Pack

800 Piece Insulated Crimp Terminal Kit with Hand Crimp Tool

- Contains 800 widely used terminal types and sizes
- Colour coded insulation for easy terminal size identification
- Plastic sleeve on terminals provides insulation and wire support
- Tin plating for good corrosion protection.
- Excellent electrical connection
- Sturdy plastic carrying case with compartments for ease of selection
- Integrated handles for easy portability
- Crimp tool for crimping wire size ranges from 0.25 to 6 mm²



613-9952 800 Piece Insulated Terminal + 1 Crimp tool

Tubular Ring Terminals

- Made from copper with a tin plating
- Ideal for use on multi-stranded cables
- Available with a flared or a chamfered entry for ease of wire insertion



841-7601 M5, 10mm², 100 Pack

841-7598 M6, 6mm², 100 Pack

841-7605 M6, 10mm², 100 Pack

841-7617 M6, 16mm², 100 Pack

841-7620 M6, 25mm², 50 Pack

841-7608 M8, 8mm², 100 Pack

841-7614 M8, 10mm², 100 Pack

841-7611 M8, 16mm², 100 Pack

841-7623 M8, 25mm², 50 Pack

841-7636 M8, 35mm², 50 Pack

841-7627 M10, 25mm², 50 Pack

841-7639 M10, 35mm², 50 Pack

841-7633 M10, 50mm², 50 Pack

841-7645 M10, 70mm², 50 Pack

841-7658 M10, 95mm², 10 Pack

841-7655 M10, 120mm², 10 Pack

841-7667 M10, 150mm², 10 Pack

841-7642 M12, 50mm², 50 Pack

841-7649 M12, 70mm², 50 Pack

841-7651 M12, 95mm², 10 Pack

841-7664 M12, 120mm², 10 Pack

841-7661 M12, 150mm², 10 Pack

Insulated Spade Connectors

- Made from copper with a tin plating
- Vinyl or nylon insulation with a flared design for easy wire insertion
- Colour coded to correspond with the wire size they are used with
- Various metric sizes available



534-632 Blue M3.5, 1.5 - 2.5mm², 100 Pack

534-626 Blue M4, 1.5 - 2.5mm², 100 Pack

613-9435 Blue M4, 6.4mm, 1.5 - 2.5mm², 100 Pack

613-9514 Blue M5, 1.5 - 2.5mm², 100 Pack

534-604 Blue M6, 1.5 - 2.5mm², 100 Pack

239-4177 Mini-Yellow M3, 0.2 - 0.5mm², 100 Pack

208-2515 Red M3, 0.5 - 1.5mm², 100 Pack

613-9384 Red M3, 5.7mm, 0.5 - 1.5mm², 100 Pack

534-272 Red M3.5, 0.5 - 1.5mm², 100 Pack

613-9441 Red M3.5, 5.7mm, 0.5 - 1.5mm², 100 Pack

125-1957 Red M3.5, 22-16 AWG, 100 Pack

534-266 Red M4, 0.5 - 1.5mm², 100 Pack

613-9479 Red M4, 6.4mm, 0.5 - 1.5mm², 100 Pack

125-1958 Red M4, 22-16 AWG, 100 Pack

613-9491 Red M5, 8.1mm, 0.5 - 1.5mm², 100 Pack

534-244 Red M6, 0.5 - 1.5mm², 100 Pack

534-496 Yellow M4, 2.5 - 6.5mm², 100 Pack

613-9564 Yellow M4, 7.2mm, 4 - 6mm², 100 Pack

534-480 Yellow M5, 2.5 - 6.5mm², 100 Pack

Insulated Double Crimp Spade Terminals

- Made from brass with a copper sleeved barrel
- Vinyl or nylon insulation with a flared design for easy wire insertion
- Colour coded to correspond with the wire size they are used with



267-3852 Blue M3.5, 1 - 2.6mm², 100 Pack

267-3846 Blue M4, 1 - 2.6mm², 100 Pack

267-3717 Red M3, 0.5 - 1.5mm², 100 Pack

267-3701 Red M3.5, 0.5 - 1.5mm², 100 Pack

267-3694 Red M4, 0.5 - 1.5mm², 100 Pack

750 Piece Insulated Crimp Terminal Kit

- 750 widely used terminal types and sizes
- Colour coded terminal sleeves for insulation and wire size identification
- Sturdy plastic carrying case with compartments and integral carrying handle



613-9974 750 Piece Kit

French Colour Coded Bootlace Ferrule Crimp Terminal Kit

- Portable, compact and uncluttered storage in minimum space
- Both kits contain 8 Ferrule compartments
- Plastic see-through cover
- Marked compartments, sorted by size and ease of selection



228-0321 0.5-10mm², 1000 pcs

Bootlace Ferrule Kit

- Colour coded insulation for easy ferrule size identification
- Excellent electrical connection
- Crimped terminal can be repeatedly inserted and removed from connection without degrading end of the wire
- Transparent plastic circular box for portable, compact and uncluttered storage
- 5 marked compartments sorted by size for ease of selection



513-2540 400 Piece kit, 0.5 - 2.5mm²

Crimping Pliers

- A full range of professional crimping pliers to ensure a high quality connection - both electrically and mechanically - between the ferrule and the wire.



683-1605 Crimp Tool, End Splice, 0.5 - 6mm², Square Crimping Profile

683-1614 Crimp Tool, End Splice, 10 - 25mm², Square Crimping Profile

Ratchet Crimping Tools

- Insulated AMP-type flag tool has 2 crimping cavities
- Heatshrink & Insulated terminal tool has 3 crimping cavities; 1.25mm² (22-16 AWG), 2mm² (16-14 AWG) and 5.5mm² (12-10 AWG)



125-1966 AMP flag terminals

125-1965 Heatshrink terminals

125-1964 Insulated terminals

Crimping Pliers

- A full range of professional crimping pliers to ensure a high quality connection - both electrically and mechanically - between the ferrule and the wire.



122-1791 0.14-10.00mm², Hexagon Profile

122-1790 0.14-10.00 mm², Square Profile

Ratchet Crimping Tool

- Durable and easy to use
- Made from high-quality hardened alloy steel
- Ratchet mechanism ensures that full crimp cycle is achieved
- Ratchet release mechanism
- Adjustable crimping force
- Ergonomically designed, non-slip handles for comfortable use



399-2031 0.5 - 16 mm², Square profile

Plier Action Bootlace Ferrule Hand Crimp Tool

- Plier action hand crimp tool for crimping bootlace ferrules



464-482 0.5 - 16 mm², Square profile

Sub-miniature Cable Ties

- For reduced diameter retention applications
- Available in either black or white
- Flammability rating UL94V-2



| Stock No. | Width | Length | Colour | Pack Size |
|-----------|--------|--------|--------|-----------|
| 664-2887 | 1.6 mm | 71mm | Black | 100 |
| 664-2883 | 1.6 mm | 71mm | White | 100 |

Coloured Nylon Cable Ties

- Enable colour coding of cables or other components
- Temp rating: -50°C to +85°C
- Flammability rating UL94V-2



| Stock No. | Width | Length | Colour | Pack Size |
|-----------|-------|--------|--------|-----------|
| 233-275 | 2.5mm | 160mm | Green | 100 |
| 404-550 | 3.6mm | 203mm | Orange | 100 |
| 233-297 | 2.5mm | 200mm | Red | 100 |

Double Locking Cable Ties

- Features a non-releasable double locking head
- Double locking design results in a more rounded shape around the cables
- Manufactured from UL listed Nylon 66
- Available in black or natural, in a range of sizes



| Stock No. | Width | Length | Colour | Pack Size |
|-----------|-------|--------|--------|-----------|
| 865-9625 | 6mm | 132mm | Black | 100 |
| 865-9629 | 6mm | 180mm | Black | 100 |
| 865-9631 | 9mm | 201mm | Black | 100 |
| 865-9635 | 9mm | 265mm | Black | 100 |
| 865-9647 | 9mm | 360mm | Black | 100 |
| 865-9641 | 9mm | 382mm | Black | 100 |
| 865-9650 | 9mm | 510mm | Black | 100 |
| 865-9653 | 9mm | 610mm | Black | 100 |

UV Resistant Cable Ties

- Weather resistant cable ties with excellent UV resistance
- Easy and fast to install
- Ideal for use outdoors
- Available in a range of sizes



| Stock No. | Width | Length | Colour | Pack Size |
|-----------|--------|--------|--------|-----------|
| 811-1482 | 2.5mm | 100mm | Black | 100 |
| 811-1486 | 3.2 mm | 140 mm | Black | 100 |
| 811-1495 | 4.8 mm | 190 mm | Black | 100 |
| 811-1498 | 4.6 mm | 200 mm | Black | 100 |
| 811-1518 | 7.6 mm | 240 mm | Black | 100 |
| 811-1511 | 7.6 mm | 300 mm | Black | 100 |
| 811-1492 | 4.8 mm | 380 mm | Black | 100 |
| 811-1502 | 4.8 mm | 450 mm | Black | 100 |
| 811-1515 | 8 mm | 450 mm | Black | 100 |
| 811-1524 | 9 mm | 610 mm | Black | 100 |
| 811-1527 | 7.5 mm | 750 mm | Black | 100 |

Flame Retardant Nylon Cable Ties

- Ideal for use where fire resistance is critical
- Flame Retardant to UL 94V-0 standard
- Available in either black or natural colour in a range of sizes
- Sold in pack of 100



| Stock No. | Width | Length | Colour | Pack Size |
|-----------|--------|--------|---------|-----------|
| 811-1773 | 2.5mm | 100mm | Black | 100 |
| 811-1776 | 3.6mm | 150mm | Black | 100 |
| 811-1779 | 4.8mm | 203mm | Black | 100 |
| 811-1739 | 17.8mm | 254mm | Black | 50 |
| 811-1748 | 12.7mm | 280mm | Black | 50 |
| 811-1751 | 12.7mm | 280mm | Natural | 50 |
| 811-1741 | 12.7mm | 380mm | Black | 50 |
| 811-1760 | 12.7mm | 380mm | Natural | 50 |
| 811-1782 | 7.6mm | 380mm | Black | 100 |
| 811-1745 | 12.7mm | 480mm | Black | 50 |
| 811-1754 | 12.7mm | 550mm | Black | 50 |
| 811-1767 | 12.7mm | 550mm | Natural | 50 |

Standard Nylon Cable Ties

- Ideal for bundling and organising cables and wires
- Suitable for a multitude of uses
- Black and natural colours available in a range of sizes
- Self-extinguishing to rating UL94V-2



| Stock No.  | Width | Length | Colour | Pack Size |
|---|--------|--------|---------|-----------|
| 233-455 | 2.5mm | 100mm | Black | 100 |
| 233-499 | 2.5mm | 100mm | Black | 1000 |
| 178-462 | 2.5mm | 100mm | White | 100 |
| 492-0447 | 2.5mm | 100mm | White | 1000 |
| 811-1694 | 2.5mm | 203mm | Natural | 100 |
| 233-465 | 3.6mm | 150mm | Black | 100 |
| 178-478 | 3.6mm | 150mm | White | 100 |
| 233-500 | 3.6mm | 150mm | Black | 1000 |
| 233-477 | 3.6mm | 292mm | Black | 100 |
| 178-490 | 3.6mm | 292mm | Natural | 100 |
| 233-471 | 4.6mm | 203mm | Black | 100 |
| 811-1666 | 4.6mm | 203mm | Black | 100 |
| 811-1710 | 4.8mm | 160mm | Natural | 100 |
| 233-506 | 4.8mm | 188mm | Black | 100 |
| 178-484 | 4.8mm | 188mm | White | 100 |
| 489-2140 | 4.8mm | 200mm | Natural | 100 |
| 811-1697 | 4.8mm | 250mm | Black | 100 |
| 489-2156 | 4.8mm | 295mm | White | 100 |
| 233-487 | 4.8mm | 300mm | Black | 100 |
| 811-1650 | 4.8mm | 300mm | Black | 1000 |
| 811-1662 | 4.8mm | 368mm | Black | 1000 |
| 233-483 | 4.8mm | 368mm | Black | 100 |
| 178-507 | 4.8mm | 368mm | Natural | 100 |
| 811-1707 | 4.8mm | 385mm | Natural | 100 |
| 811-1688 | 7.6mm | 300mm | Black | 100 |
| 811-1684 | 7.6mm | 340mm | Black | 100 |
| 233-493 | 7.6mm | 380mm | Black | 100 |
| 811-1669 | 7.6mm | 380mm | Black | 1000 |
| 178-513 | 7.6mm | 380mm | White | 100 |
| 811-1678 | 8.0mm | 450mm | Black | 100 |
| 811-1672 | 9.0mm | 610mm | Black | 100 |
| 811-1681 | 9.0mm | 762mm | Black | 100 |
| 811-1675 | 12.7mm | 550mm | Black | 100 |
| 811-1701 | 12.7mm | 550mm | Natural | 100 |

Assorted Nylon Cable Tie Canister Pack

- Colours: Natural, Black, Red, Yellow, Blue, Green, Purple, Grey, Orange, Neon Yellow
- Flame retardant



233-118 100 x 2.5mm, Pack of 1000

TG Cable Tie Tools

- Quickly tensions and automatically cut cable ties
- Flush tie cut-off eliminates sharp edges for safety



811-1732 1.8 - 4.8mm

811-1735 2.5 - 10.0mm

Cable Tie Installation Pliers

- A hand-operated plier for tightening and trimming cable ties up to 5 mm width
- Tension and manually cut cable ties
- Suitable for use with all standard cable ties



549-909 Up to 5mm

WALL BOXES & ACCESSORIES

Protect your critical components with RS PRO's range of durable enclosures and wall boxes, designed for optimal organisation and safety in challenging environments.

Top Hat DIN Rail

- A selection of robust TS-35 standard DIN rails used for mounting various electrical and industrial equipment.
- Manufactured from cold rolled steel which is then zinc coated and clear passivated.
- This ensures its strength and corrosion proof properties.
- Un-slotted profiles and available in various lengths for easy attachment and wiring.



467-416 Slotted, 1m x 35 mm x 7.5 mm, 6mm hole size

467-400 Unslotted, 2m x 35mm x 7.5mm

DIN Rail Mounting Square Brackets, TS Series

- Zinc coated steel snap-on mounting brackets with a M6 tapped holes
- Fits all TS35 top hat mounting rails.
- Zinc coated mild steel
- Sold in a Pack of 10



467-383 Square bracket, 20mm height

467-343 Square bracket, 40mm height

467-361 Square bracket, 70mm height

467-371 Square bracket, 90mm height

Drain Plug

- Polycarbonate plug
- Can be fixed to panels and equipment to enable the drain plug to be mounted and de-mounted from outside of the equipment.
- Incorporates a filter to drain liquids from an enclosure at 30cc/min whilst preventing dust, dirt etc. from entering the enclosure



838-827 Black

Air Vents

- Ideal for regulating air circulation and temperature control
- Suitable for a variety of applications
- Easy to install
- Rubber gasket with IP54 protection



192-7137 White, 50mm x 15.8mm x 68mm

192-7136 White, 28.45mm x 21.88mm x 25.75mm

Insulated ABS Wall Boxes

- A high quality insulated wall mount enclosure designed for outdoor applications and harsh environments
- Constructed of ABS material which gives a smooth, high gloss finish, with good resistance to chemical attack and excellent insulating properties
- 200° door opening
- Temperature rating -25 to +60°C
- RoHS compliant with IP65 protection



**IP65
RATED**

| | |
|-----------------|--------------------|
| 746-7393 | 280 x 210 x 130 mm |
| 746-7396 | 400 x 300 x 165 mm |
| 746-7390 | 400 x 300 x 195 mm |
| 746-7400 | 500 x 400 x 175 mm |
| 746-7403 | 600 x 400 x 200 mm |

Stainless Steel Wall Box with Chassis Plate

- IP66 wall box
- Constructed from 1.2 mm AISI 304 natural finish stainless steel
- Plain door with single lock
- IK10 protection against mechanical impacts
- Zinc coated 1.5 mm steel chassis plate

**IP66
RATED**

Sheet Steel Wall Boxes

- Providing IP66 and IK10 protected
- Polyester epoxy powder coat textured finish RAL 7032
- Enclosure and door made from sheet steel either 1.2 mm or 1.5 mm thick (depending on size)
- Mounting plate is made from zinc-coated steel either 1.5 mm or 2.0 mm (depending on size)

**IP66
RATED**

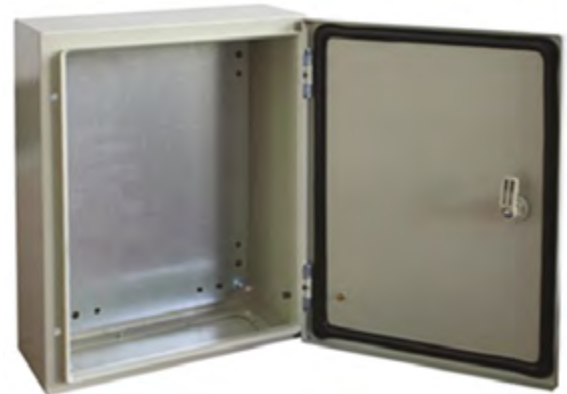

| | |
|-----------------|--------------------|
| 842-8406 | 300 x 300 x 150 mm |
| 842-8370 | 300 x 300 x 200 mm |
| 842-8361 | 300 x 400 x 150 mm |
| 842-8342 | 300 x 400 x 200 mm |
| 842-8380 | 400 x 300 x 150 mm |
| 842-8383 | 400 x 300 x 200 mm |
| 842-8392 | 400 x 400 x 150 mm |
| 842-8409 | 400 x 400 x 200 mm |

| | |
|-----------------|--------------------|
| 775-5300 | 300 x 250 x 150 mm |
| 775-5319 | 300 x 300 x 210 mm |
| 775-5312 | 300 x 400 x 210 mm |
| 775-5316 | 400 x 300 x 210 mm |
| 775-5325 | 400 x 400 x 210 mm |
| 775-5328 | 400 x 600 x 210 mm |
| 775-5322 | 500 x 400 x 210 mm |
| 775-5331 | 500 x 500 x 210 mm |
| 775-5334 | 500 x 500 x 300 mm |
| 775-5788 | 300 x 200 x 150 mm |
| 775-5791 | 300 x 300 x 150 mm |
| 775-5794 | 300 x 400 x 200 mm |
| 775-5798 | 400 x 300 x 150 mm |
| 775-5808 | 400 x 300 x 200 mm |
| 775-5801 | 400 x 400 x 200 mm |

Rear mount Door Interlocked Isolator

- Rear of panel mounting isolators complete with handle and shaft with AC-22 rating
- The switch mounts at the rear of the enclosure, either on 35mm DIN rail or via two screw fixing
- The handle is interlocked ensuring removal only in the OFF position, and is padlockable in the OFF position
- Maximum panel thickness is 3mm
- Metal shaft length: 282mm (3 pole) and 94mm (6 pole)



IP65 RATED

Metal Clad Enclosed Isolators

- Enclosed isolators in RAL7032 grey epoxy coated steel with IP54 protection
- Padlockable handle
- Choice of 3 or 4 pole configuration with the optional auxiliary contacts - see 466-251

IP54 RATED



| | |
|---------|-------------|
| 466-176 | 32A 3 Pole |
| 466-273 | 25A 3 Pole |
| 466-283 | 40A 3 Pole |
| 466-277 | 63A 3 Pole |
| 466-267 | 80A 3 Pole |
| 466-160 | 125A 3 Pole |

Plastic Boxed Electrical Isolators

- Electrical isolators in IP65 sealed housings with padlockable handles for added safety
- M20 gland positions (must be drilled out) on sides



IP65 RATED

| | |
|---------|--------------------|
| 466-249 | 4 Pole, 7.5kW, 20A |
| 466-233 | 25A 4 Pole |
| 466-227 | 32A 4 Pole |
| 466-172 | 3 Pole, 11kW, 32A |
| 466-239 | 40A 4 Pole |
| 466-223 | 63A 4 Pole |
| 466-217 | 80A 4 Pole |

| | |
|----------|-------------|
| 773-8002 | 25A 3 Pole |
| 773-8011 | 32A 3 Pole |
| 773-8014 | 40A 3 Pole |
| 773-8018 | 63A 3 Pole |
| 773-8027 | 80A 3 Pole |
| 773-8020 | 25A 4 Pole |
| 773-8024 | 32A 4 Pole |
| 773-8033 | 40A 4 Pole |
| 773-8036 | 63A 4 Pole |
| 773-8030 | 80A 4 Pole |
| 773-8049 | 100A 4 Pole |
| 773-8042 | 125A 4 Pole |

Panel Mount (Padlockable)

- Panel mount switch disconnectors for use with low voltage switchgear such as power distribution, load isolation and motor start/stop
- All switch ratings at AC-22
- Maximum panel thickness 3mm
- Actuator dimensions 64x64x32mm



| | |
|---------|------------|
| 466-148 | 25A 3 Pole |
| 466-150 | 32A 3 Pole |
| 466-138 | 63A 3 Pole |

Large Box Enclosed Isolators

- Plastic IP65 enclosed isolators in an over-sized box to aid wiring when space isn't an issue
- Ideal if working with steel wire armoured cable or conduit
- Interlocking lid ensures removal in the OFF position only
- Padlockable handles
- Flame retardant material



| | |
|---------|-------------|
| 466-122 | 100A 4 Pole |
| 466-132 | 125A 4 Pole |

IP65 RATED

Enclosed Change-Over Switches

- ABS plastic enclosed 2 pole changeover switch with padlockable handle
- IP65 protected
- AC-21 Rated

IP65 RATED



| | |
|----------|------------|
| 860-9554 | 25A 2 Pole |
| 860-9557 | 32A 2 Pole |
| 860-9551 | 40A 2 Pole |

Axial Fan Square Fitting

- RS brushless high performing ball bearing fans provide a general purpose, compact, cost-effective and reliable solution to a variety of requirements
- Black construction



| Stock No. | Dimensions | Supply Voltage | Air Flow | Power Consumption |
|-----------|--------------------|----------------|------------------------|-------------------|
| 619-6804 | 120 x 120 x 38mm | 230Vac | 187m ³ /h | 15W |
| 619-6775 | 120 x 120 x 38mm | 115Vac | 187m ³ /h | 15W |
| 619-6905 | 180 x 180 x 89mm | 115Vac | 637.5m ³ /h | 70W |
| 619-6933 | 180 x 180 x 89mm | 230Vac | 637m ³ /h | 70W |
| 619-7015 | 80 x 80 x 38mm | 230Vac | 52.7m ³ /h | 12W |
| 541-4965 | 60 x 60 x 25mm | 12 dc | 30.6m ³ /h | 1.7W |
| 541-5227 | 60 x 60 x 25mm | 24 V dc | 30.6m ³ /h | 1.9W |
| 541-4987 | 60 x 60 x 25mm | 12Vdc | 40.8m ³ /h | 2.8W |
| 668-8827 | 60 x 60 x 25mm | 12Vdc | 42.5m ³ /h | 2.8W |
| 541-5249 | 60 x 60 x 25mm | 24Vdc | 40.8m ³ /h | 3.5W |
| 541-5003 | 80 x 80 x 15mm | 12Vdc | 39.1m ³ /h | 1.8W |
| 541-5025 | 80 x 80 x 15mm | 12Vdc | 51m ³ /h | 2.3W |
| 541-5255 | 80 x 80 x 15mm | 24Vdc | 32.3m ³ /h | 2.4W |
| 541-5277 | 80 x 80 x 15mm | 24Vdc | 51m ³ /h | 4.6W |
| 541-5283 | 80 x 80 x 25mm | 24Vdc | 48m ³ /h | 0.96W |
| 541-5299 | 80 x 80 x 25mm | 24Vdc | 56.07m ³ /h | 1.67W |
| 541-5306 | 80 x 80 x 25mm | 24Vdc | 68m ³ /h | 2.41W |
| 541-5328 | 92.5 x 92.5 x 25mm | 24Vdc | 74.8m ³ /h | 2.9W |
| 703-3458 | 92.5 x 92.5 x 38mm | 48Vdc | 229.5m ³ /h | 17W |

Plastic Finger Guards

- Suitable for use with axial fans



| | |
|----------|-------------------|
| 737-4055 | 120mm, Pack of 10 |
| 737-4049 | 60mm, Pack of 10 |

Axial Fan Round Fitting - AC

- Die cast Aluminium frame
- 60,00 hours life time
- Dual Ball Bearing



| | |
|----------|--|
| 619-6848 | 172 (Dia.) x 51mm, 399.5m ³ /h, 35W, 230Vac |
| 619-6860 | 172 (Dia.) x 51mm, 510m ³ /h, 50W, 230Vac |
| 619-6832 | 172 (Dia.) x 51mm, 399.5m ³ /h, 35W, 115Vac stadium |
| 619-6927 | 254 (Dia.) x 88.9mm, 547m ³ /h, 35W, 115Vac |
| 619-6949 | 254 (Dia.) x 88.9mm, 929m ³ /h, 35W, 230Vac |

Sealed Sleeve Axial Fan

- Sealed sleeve technology retains bearing lubricant
- Long life expectancy (more than 50,000 hours)
- Black construction



| | |
|----------|---|
| 668-8801 | 40 x 40 x 10mm, 11.4m ³ /h, 1.4W, 24Vdc |
| 789-7867 | 50 x 50 x 10.5mm, 19m ³ /h, 1.44W, 12Vdc |
| 541-5182 | 60 x 60 x 15mm, 20.4m ³ /h, 1.2W, 24Vdc |
| 541-5198 | 60 x 60 x 15mm, 23.8m ³ /h, 1.7W, 24Vdc |
| 541-5205 | 60 x 60 x 15mm, 32.3m ³ /h, 2.2W, 24Vdc |

Metal Finger Guards

- Steel wire with welded joints withstands 220 lbs separation force to meet UL/CUL standards



| | |
|----------|-------------------------|
| 619-6911 | Chrome 180mm |
| 737-4020 | Chrome 225mm, Pack of 5 |
| 619-7021 | Chrome 254mm |

Round Top Nylon 66 Cable Gland

- UL listed Nylon 66 material
- Simple and easy to use
- IP68 protection
- PG thread to DIN standard with washer assembled
- Available in a range of colours and thread sizes

**IP68
RATED**



| Stock No. | Thread Size | Colour | Pack Size |
|-----------|-------------|--------|-----------|
| 822-9666 | PG7 | Black | 10 |
| 822-9640 | PG7 | Grey | 10 |
| 822-9675 | PG9 | Black | 10 |
| 822-9644 | PG9 | Grey | 10 |
| 822-9678 | PG11 | Black | 10 |
| 822-9653 | PG11 | Grey | 10 |
| 822-9672 | PG13.5 | Black | 10 |
| 822-9656 | PG13.5 | Grey | 10 |
| 822-9681 | PG16 | Black | 10 |
| 822-9650 | PG16 | Grey | 10 |
| 822-9684 | PG21 | Black | 10 |
| 822-9669 | PG21 | Grey | 10 |
| 822-9688 | PG29 | Black | 10 |
| 822-9662 | PG29 | Grey | 10 |

Nylon Locknuts

- A selection of 1.5 mm pitch Metric locknuts
- Threads Metric Conduit BS3643
- Complies with EU Directive 2002/95/EC-ROHS
- Complies with EU Directive 2002/96/EU Waste Electrical Equipment-WEEE



| Stock No. | Thread Size | Colour | Material | Pack |
|-----------|-------------|--------|----------|------|
| 127-259 | M16 | Black | PA 6 | 25 |
| 127-417 | M20 | Black | PA 6 | 25 |
| 127-653 | M25 | Black | PA 6 | 25 |

Metric Dome Top Gland

- Supplied complete with locknut and entry thread seal.
- Manufactured from UL approved Nylon 66
- Flammability rating to UL 94V-2
- Provides watertight seal to IP68
- Offers strain relief and protection for cables

**IP68
RATED**



| Stock No. | Thread Size | Colour | Pack Size |
|-----------|-------------|--------|-----------|
| 669-4667 | M16 | Black | 5 |
| 669-4676 | M25 | Black | 5 |
| 669-4670 | M32 | Black | 5 |
| 669-4689 | M40 | Black | 5 |
| 669-4658 | M12 | Black | 100 |
| 669-4682 | M50 | Black | 5 |
| 669-4654 | M12 | Black | 5 |
| 669-4673 | M20 | Black | 5 |
| 669-4660 | M20 | Black | 5 |
| 669-4664 | M20 | Black | 5 |
| 669-4686 | M63 | Black | 5 |

Round Top Nylon 66 Cable Gland

- UL listed Nylon 66 material
- Simple and easy to use
- IP68 protection
- PG thread to DIN standard with washer assembled
- Available in a range of colours and thread sizes

**IP68
RATED**



| Stock No. | Thread Size | Colour | Pack Size |
|-----------|-------------|--------|-----------|
| 822-9739 | M12 x 1.5 | Grey | 10 |
| 822-9748 | M16 x 1.5 | Grey | 10 |
| 822-9741 | M20 x 1.5 | Grey | 10 |
| 822-9757 | M20S x 1.5 | Grey | 10 |
| 822-9745 | M25 x 1.5 | Grey | 10 |
| 822-9751 | M25S x 1.5 | Grey | 10 |
| 822-9754 | M32 x 1.5 | Grey | 10 |
| 822-9767 | M16 x 1.5 | White | 10 |
| 822-9776 | M20 x 1.5 | White | 10 |
| 822-9782 | M20S x 1.5 | White | 10 |
| 822-9779 | M25 x 1.5 | White | 10 |
| 822-9785 | M25S x 1.5 | White | 10 |
| 822-9773 | M32 x 1.5 | White | 10 |
| 822-9789 | M20 x 1.5 | Red | 10 |
| 822-9798 | M25 x 1.5 | Red | 10 |
| 822-9763 | M25S x 1.5 | Black | 10 |

Cable Gland Selection Chart

Use the table below to assist in gland size selection for your cable.

The gland sizes recommended in this chart are for guidance only and are based on cables manufactured to BS 5467.

We advise that the most accurate way to select your gland is based on the measurement of your cable.

| CABLE SIZE MM | SINGLE CORE | NUMBER OF CORES | | | | | | | | | | | |
|------------------|----------------|-----------------|-----|-----|-----|-----|----|----|----|----|----|----|--|
| | | 2 | 3 | 4 | 5 | 7 | 10 | 12 | 19 | 27 | 37 | 48 | |
| 1.5 | N/A | 20S | 20S | 20S | 20S | 20S | 20 | 20 | 25 | 32 | 32 | 32 | |
| 2.5 | N/A | 20S | 20S | 20S | 20S | 20 | 25 | 25 | 25 | 32 | 40 | 40 | |
| 4 | N/A | 20S | 20S | 20 | 20 | 25 | 25 | 32 | 32 | 40 | 40 | 50 | |
| 6 | N/A | 20 | 20 | 20 | 20 | 25 | 32 | - | - | - | - | - | |
| 10 | N/A | 20 | 25 | 25 | 25 | 32 | 32 | - | - | - | - | - | |
| 16 | N/A | 25 | 25 | 25 | 25 | 32 | - | - | - | - | - | - | |
| 25 | N/A | 25 | 25 | 32 | 32 | 40 | - | - | - | - | - | - | |
| 35 | N/A | 32 | 32 | 32 | 40 | - | - | - | - | - | - | - | |
| 50 | 20 | 25 | 32 | 32 | 50 | - | - | - | - | - | - | - | |
| 70 | 20 | 32 | 32 | 40 | 50 | - | - | - | - | - | - | - | |
| 95 | 25 | 32 | 40 | 50S | - | - | - | - | - | - | - | - | |
| 120 | 25 | 40 | 50S | 50 | - | - | - | - | - | - | - | - | |
| 150 | 32 | 40 | 50S | 50 | - | - | - | - | - | - | - | - | |
| 185 | 32 | 50S | 50 | 63S | - | - | - | - | - | - | - | - | |
| 240 | 32 | 50 | 63S | 63 | - | - | - | - | - | - | - | - | |
| 300 | 40 | 63S | 63 | 75S | - | - | - | - | - | - | - | - | |
| 400 | 40 | 63S | 75S | 75 | - | - | - | - | - | - | - | - | |

Strain Relief Cable Glands

- Designed with strain relief protection
- UL listed Nylon 66 material
- Protects cables from breakage and right angle bending
- Sealing to IP68
- Available in black or grey in a range of thread sizes



Cable Gland Adaptors

- Enable switching from small metric external thread to large metric
- UL approved Nylon 66 material



| Stock No. | Thread Size | Colour | Pack Size |
|-----------|-------------|--------|-----------|
| 822-9631 | M12 x 1.5 | Black | 10 |
| 822-9634 | M16 x 1.5 | Black | 10 |
| 822-9638 | M16 x 1.5 | Black | 10 |
| 822-9647 | M16 x 1.5 | Black | 10 |
| 822-9616 | M12 x 1.5 | Grey | 10 |
| 822-9625 | M16 x 1.5 | Grey | 10 |
| 822-9628 | M16 x 1.5 | Grey | 10 |
| 822-9622 | M16 x 1.5 | Grey | 10 |
| 822-9593 | PG7 | Black | 10 |
| 822-9603 | PG9 | Black | 10 |
| 822-9606 | PG11 | Black | 10 |
| 822-9600 | PG13.5 | Black | 10 |
| 822-9619 | PG16 | Black | 10 |
| 822-9612 | PG21 | Black | 10 |
| 822-9571 | PG7 | Grey | 10 |
| 822-9580 | PG9 | Grey | 10 |
| 822-9583 | PG11 | Grey | 10 |
| 822-9587 | PG13.5 | Grey | 10 |
| 822-9596 | PG16 | Grey | 10 |

| Stock No. | Type | Thread Size | Colour |
|-----------|-----------|--------------------|--------|
| 822-9861 | Enlarger | M12x1.5 to M16x1.5 | Black |
| 822-9864 | Enlarger | M16x1.5 to M20x1.5 | Black |
| 822-9877 | Enlarger | M25x1.5 to M32x1.5 | Black |
| 822-9868 | Enlarger | M20x1.5 to M25x1.5 | Black |
| 822-9846 | Enlarger | M12x1.5 to M16x1.5 | Grey |
| 822-9855 | Enlarger | M16x1.5 to M20x1.5 | Grey |
| 822-9858 | Enlarger | M20x1.5 to M25x1.5 | Grey |
| 822-9852 | Enlarger | M25x1.5 to M32x1.5 | Grey |
| 822-9870 | Reducer | M16x1.5 to M12x1.5 | Black |
| 822-9874 | Reducer | M20x1.5 to M16x1.5 | Black |
| 822-9883 | Reducer | M25x1.5 to M20x1.5 | Black |
| 822-9886 | Reducer | M32x1.5 to M25x1.5 | Black |
| 822-9880 | Reducer | M16x1.5 to M12x1.5 | Grey |
| 822-9899 | Reducer | M20x1.5 to M16x1.5 | Grey |
| 822-9892 | Reducer | M25x1.5 to M20x1.5 | Grey |
| 822-9896 | Reducer | M32x1.5 to M25x1.5 | Grey |
| 817-8889 | Converter | PG11x8 - M16x1.5 | Black |
| 817-8883 | Converter | PG13.5x8 - M16x1.5 | Black |
| 817-8886 | Converter | PG9x8 - M16x1.5 | Black |

PVC Cable Trunking

- Self-extinguishing to UL94-V2
- Warp-proof PVC with a slot gap of 8mm
- Available in 1 or 2m lengths
- Open or Narrow slot



| Stock No. | Colour | Material | Slot | W | H | Length |
|-----------|--------|----------|------|-------|-------|--------|
| 301-2084 | Black | PVC | 8mm | 25mm | 30mm | 2m |
| 301-2107 | Black | PVC | 8mm | 40mm | 40mm | 2m |
| 301-2129 | Black | PVC | 8mm | 50mm | 50mm | 2m |
| 136-9146 | Grey | PVC | 5mm | 25mm | 25mm | 2m |
| 136-9155 | Grey | PVC | 5mm | 75mm | 75mm | 2m |
| 879-3753 | Grey | PVC | 4mm | 80mm | 80mm | 1m |
| 879-3741 | Grey | PVC | 4mm | 40mm | 60mm | 1m |
| 879-3747 | Grey | PVC | 4mm | 40mm | 80mm | 1m |
| 879-3750 | Grey | PVC | 4mm | 60mm | 80mm | 1m |
| 758-9260 | Grey | PVC | 8mm | 15mm | 25mm | 2m |
| 758-9272 | Grey | PVC | 8mm | 25mm | 40mm | 2m |
| 758-9276 | Grey | PVC | 8mm | 25mm | 60mm | 2m |
| 758-9288 | Grey | PVC | 8mm | 40mm | 40mm | 2m |
| 758-9282 | Grey | PVC | 8mm | 40mm | 60mm | 2m |
| 758-9291 | Grey | PVC | 8mm | 40mm | 80mm | 2m |
| 879-3725 | Grey | PVC | 8mm | 40mm | 40mm | 1m |
| 879-3731 | Grey | PVC | 8mm | 40mm | 60mm | 1m |
| 879-3738 | Grey | PVC | 8mm | 40mm | 80mm | 1m |
| 879-3744 | Grey | PVC | 8mm | 60mm | 80mm | 1m |
| 879-3735 | Grey | PVC | 8mm | 80mm | 80mm | 1m |
| 879-3713 | Grey | PVC | 8mm | 25mm | 25mm | 1m |
| 879-3722 | Grey | PVC | 8mm | 60mm | 60mm | 1m |
| 879-3729 | Grey | PVC | 8mm | 100mm | 100mm | 1m |
| 301-1924 | Grey | PVC | 8mm | 25mm | 25mm | 2m |
| 301-1946 | Grey | PVC | 8mm | 45mm | 33mm | 2m |
| 301-1930 | Grey | PVC | 8mm | 45mm | 25mm | 2m |
| 301-1974 | Grey | PVC | 8mm | 50mm | 50mm | 2m |
| 301-1968 | Grey | PVC | 8mm | 45mm | 45mm | 2m |
| 301-1980 | Grey | PVC | 8mm | 65mm | 25mm | 2m |
| 301-2006 | Grey | PVC | 8mm | 60mm | 60mm | 2m |
| 301-2012 | Grey | PVC | 8mm | 65mm | 65mm | 2m |
| 301-1996 | Grey | PVC | 8mm | 65mm | 45mm | 2m |
| 301-2056 | Grey | PVC | 8mm | 100mm | 75mm | 2m |
| 301-2062 | Grey | PVC | 8mm | 100mm | 100mm | 2m |

Halogen Free DIN Panel Grey Trunking

- Halogen free and flame retardant
- It doesn't release any corrosive or toxic gases
- Rigid PVC cable trunking
- Break points on bars and channel floor
- Available in 2 metre lengths



136-9160 W25XH25

136-9169 W50XH75

Electro-galvanised steel Cable Tray Fast Coupler

- Electro-welded, electro-galvanised steel construction

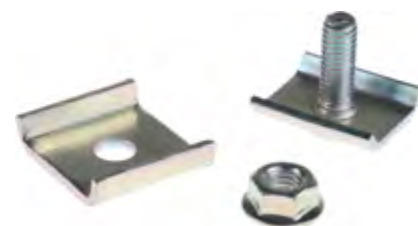

912-4710 Bag of 100

Flexible Self-Adhesive Slotted Trunking

- Polypropylene halogen free flexible slotted trunking
- Provided with strong self adhesive backing
- Round shape, low flammability and self extinguishing in accordance with UL94-V1
- Operating temperature range of -20°C to +70°C



598-591 500x11x9mm

598-608 500x20mm

598-614 500x30mm

PVC Spiral - Contractor Pack

- Good general purpose PVC conduit with a unique IP67 dual purpose connector (fixed or swivel).
- Self-extinguishing according to UL94-V0
- Shock-resistance with smooth internal surface
- Compression strength D<25% with 350N at 20°C

**IP67
RATED**



513-2354 20mm
513-2360 25mm

Contractor Conduit Pack with Fittings & Locknuts

- Nylon conduit with quick and efficient IP66 push-on connectors - 10 straight fittings and 10 locknuts
- Self-extinguishing, halogen-free
- Resistant to fuels, mineral oils, lubricants, alkalis and most commercial solvents

**IP66
RATED**



513-2376 20mm

Flexible Conduit

- Flame retardant, general purpose conduit
- Resilient to prolonged flexing and vibration
- IP55 conduit (when used with compatible fittings)
- Crush resistant to BS6099
- Resistant to: nitric acid, sulphuric acid, detergent, diesel and white spirit

**IP55
RATED**



429-688 10mm
429-672 20mm

Split Flexible Conduit

- For cable protection in electrical installations, machinery and buildings
- Special design allows bends around corners without kinking
- The split allows the conduit to be installed easily onto pre-installed wiring
- Colour: black



755-9013 16mm
875-0249 16mm, 100m
755-9017 20mm
875-0258 20mm, 100m
755-9026 25mm
755-9029 32mm

Nylon Fish Wire Draw Tape

- Draw tape with strong brass head
- Available in 10m and 20m lengths



918-4977 20m
918-4970 10m

Polypropylene Contractor Pack

- Low cost, black general-purpose conduit supplied in 10m lengths with 10 split fitting and 10 locknuts.

**IP66
RATED**



513-2332 20mm

Polyamide Terminal Blocks

- 12 way non-fused terminal block
Natural colour with a quick snap body
Screw down termination with a nickel plated brass contacts
Applications: Connecting lighting to switches, connecting wiring to a ground, HVAC Systems, Power Supplies
- Cross Section: rated for rigid wire and cables (if for flexible wire, it should be reduced one-step, i.e. 6mm² is 4mm² Φ 1 wire entry hole diameter Φ 2 fixing hole diameter



| Stock No. | Colour | Cross Section | Current Range | Rated Voltage | Pack Size |
|-----------|---------|--------------------|---------------|---------------|-----------|
| 492-8687 | Natural | 2.5mm ² | 24A | 380 V | 5 |
| 492-8700 | Natural | 4mm ² | 32A | 400 V | 5 |
| 492-8716 | Natural | 6mm ² | 41A | 400 V | 5 |
| 840-7923 | Natural | 10mm ² | 10-57A | 450V | 5 |
| 840-7960 | Natural | 6mm ² | 41 A | 450V | 5 |
| 840-7954 | Natural | 1.5mm ² | 17.5 A | 450V | 5 |
| 840-7929 | Natural | 2.5mm ² | 2.5 ~ 20 A | 450V | 5 |
| 840-7951 | Natural | 4mm ² | 32 A | 450V | 5 |
| 813-3136 | Natural | 12mm ² | 15 - 61 A | 400V | 5 |
| 813-3127 | Natural | 10mm ² | 10 - 57 A | 400V | 5 |
| 813-3139 | Natural | 16mm ² | 30 - 76 A | 400V | 5 |
| 813-3123 | Natural | 6mm ² | 5 - 32 A | 380V | 5 |
| 813-3120 | Natural | 4mm ² | 3 - 24 A | 380V | 5 |

Polyethylene Terminal Blocks

- 12 way terminal blocks
- Brass inserts and galvanised steel screws
- Natural colour
- Temperature rating: 80°C
- Pack of 10



| Stock No. | Colour | Cross Section | Temp | Current Range | Rated Voltage |
|-----------|---------|------------------|-------|---------------|---------------|
| 763-8113 | Natural | 4mm ² | 80° C | 3~24 A | 380V |
| 763-8116 | Natural | 6mm ² | 80° C | 5 ~ 32 A | 380V |
| 867-0963 | Natural | 10mm | 80° C | 10 ~ 57A | 400V |
| 867-0972 | Natural | 12mm | 80° C | 15~61A | 400V |
| 867-0975 | Natural | 16mm | 80° C | 30~76A | 400V |
| 867-0979 | Natural | 25mm | 80° C | 60~101A | 400V |

Nylon Terminal Blocks With Wire Protection Leaf

- 12 way terminal blocks
- Natural Colour
- Screw Terminals
- Wire Protection Leaf



| Stock No. | Cross Section | Temp | Current Rating | Rated Voltage |
|-----------|--------------------|-------|----------------|---------------|
| 464-9722 | 4mm ² | 125°C | 41A | 400 V |
| 464-9738 | 2.5mm ² | 125°C | 24A | 400 V |
| 464-9700 | 10mm ² | 125°C | 50A | 400 V |
| 464-9744 | 2.5mm ² | 125°C | 41A | 400 V |

Polyamide Terminal Blocks(Horizontal Plug)

- 12 way non-fused terminal block
- Natural colour with a quick snap body
- Screw down termination with a nickel plated brass contacts
- Applications: Connecting lighting to switches, connecting wiring to a ground, HVAC Systems, Power Supplies



| Stock No. | Cross Section | Temp | Current Range | Rated Voltage | Pack Size |
|-----------|------------------|--------|---------------|---------------|-----------|
| 865-9833 | 6mm ² | 105o C | 5 - 32A | 450 V | 1 |
| 865-9830 | 4mm ² | 105o C | 5 - 32A | 450 V | 1 |

Polypropylene Terminal Blocks

- Non-fused terminal block
- Lightweight, rigid, corrosion resistant and with high tensile strength
- Colour white
- Screw down terminals with brass contacts
- Pack of 5



| Stock No. | Cross Section | Temp | Current Range | Rated Voltage | Pack Size |
|-----------|--------------------|--------------|---------------|---------------|-----------|
| 703-3814 | 2.5mm ² | -40°C - 85°C | 6A | 400 V | 5 |
| 703-3818 | 4mm ² | -40°C - 85°C | 24A | 380 V | 5 |
| 703-3827 | 6mm ² | -40°C - 85°C | 20A | 380 V | 5 |

Commoning Terminal Blocks

- Compact design allows high-density connections
- Housing material: transparent blue polycarbonate
- Self-extinguishing: UL 94 - V0; IEC 692-1 to 850°C; IEC 692-2
- Maximum operating temperature: 85°C
- Clamps: Brass, Captive screws: galvanized steel
- Protection degree: IP 20



| | |
|-----------------|----------------|
| 868-0786 | 3 poles + prot |
| 868-0774 | 5 poles + prot |
| 868-0752 | 11 poles, 6-16 |
| 868-0792 | 6 poles 6-16 |
| 868-0799 | 6 poles 16-35 |
| 868-0806 | 3 poles 35 |
| 868-0755 | 4 poles 16 |

Porcelain Terminal Blocks

- Nickel plated brass inserts and galvanised steel screws
- Maximum operating temperatures: 800°C housing and 350°C inserts
- Hard and solid block material
- Non-flammable and resistant to chemicals



| | |
|-----------------|------------------------------|
| 813-3117 | 10 mm ² , 1 Pole |
| 813-3111 | 16 mm ² , 1 Pole |
| 813-3101 | 16 mm ² , 4 Poles |
| 813-3108 | 10 mm ² , 4 Poles |
| 813-3114 | 4 mm ² , 1 Pole |
| 813-3098 | 4 mm ² , 4 Poles |
| 813-3105 | 4 mm ² , 3 Poles |

Steatite Terminal Blocks

- Nickel-plated brass inserts and plated steel screws
- Suitable for use in high ambient temperatures up to 300°C
- High dielectric strength
- Non-flammable with dimensional stability up to 1000 °C
- Pack of 5



| | |
|-----------------|--------------------------|
| 703-3846 | 2 ways 4mm ² |
| 703-3858 | 2 ways 10mm ² |
| 703-3861 | 2 ways 16mm ² |
| 703-3855 | 3 ways 4mm ² |
| 703-3852 | 3 ways 10mm ² |
| 703-3864 | 3 ways 16mm ² |

Brass Earth Terminal Blocks

- Earth connecting blocks manufactured from Brass to BS2498
- Width 19mm, Height 12mm
- Sold in a Pack of 5



| Stock No. | Block Type | Wire Size | No. of Ways | Termination Method | Pack Size |
|-----------------|------------------|------------------------|-------------|--------------------|-----------|
| 283-0730 | Double Screw | 0 - 16 mm ² | 8 | Screw Down | |
| 425-544 | Double Screw | 0 - 16 mm ² | 4 | Screw Down | |
| 283-0746 | Double Screw | 0 - 16 mm ² | 5 | Screw Down | |
| 283-0768 | Double Screw | 0 - 16 mm ² | 6 | Screw Down | |
| 425-550 | Double Screw | 0 - 16 mm ² | 8 | Screw Down | |
| 867-0991 | CE (BS EN 60998) | 0 - 16 AWG | 3 | Screw Down | |
| 867-1004 | CE (BS EN 60998) | 0 - 16 AWG | 5 | Screw Down | |
| 867-1007 | CE (BS EN 60998) | 0 - 16 AWG | 8 | Screw Down | |

Standard Din Rail Terminals

- Identify signals or voltages easily due to colour coding
- Standards met: UL, CSA, NEMKO, GOST
- Sold in a Packs of 14



| Stock No. | Cable CSA | Colour | Voltage Rating | Current Rating |
|-----------|--------------------------|--------|----------------|----------------|
| 501-730 | 0.2 - 2.5mm ² | Orange | 800V | 24A |
| 501-639 | 0.2 - 2.5mm ² | Black | 800V | 24A |
| 501-613 | 0.2 - 2.5mm ² | White | 800V | 24A |
| 501-641 | 0.2 - 2.5mm ² | Yellow | 800V | 24A |
| 501-645 | 0.2 - 2.5mm ² | Black | 800V | 24A |
| 501-720 | 0.2 - 4mm ² | Brown | 800V | 32A |
| 501-803 | 0.2 - 4mm ² | Grey | 800V | 32A |
| 501-673 | 0.2 - 4mm ² | Red | 800V | 32A |
| 501-932 | 0.2 - 4mm ² | White | 800V | 32A |
| 501-651 | 0.2 - 4mm ² | Orange | 800V | 32A |
| 501-663 | 0.2 - 4mm ² | Yellow | 800V | 32A |
| 815-666 | 2.5 - 4mm | Beige | 800 V | 40A |
| 815-672 | 2.5 - 4mm | Blue | 800 V | 40A |
| 501-976 | 0.2 - 2.5mm ² | Black | 800V | 24A |
| 501-821 | 0.2 - 2.5mm ² | Red | 800V | 24A |
| 802-783 | 0.2 - 2.5mm ² | Blue | 800V | 24A |
| 501-635 | 0.2 - 2.5mm ² | Brown | 800V | 24A |

DIN Rail Screw Clamp Terminal Blocks (CDU Series)

- Suitable for a broad range of cross-section and wire types
- Excellent vibration resistance with very low contact resistance
- High reliability and maintenance free
- Easy mounting and dismounting from DIN rail



| Stock No. | Cable CSA | Colour | Voltage Rating | Pack Size |
|-----------|--------------------|--------|----------------|-----------|
| 878-7503 | 2.5mm ² | Beige | 800V | 10 |
| 878-7506 | 2.5mm ² | Grey | 800 V | 10 |
| 878-7487 | 2.5mm ² | Grey | 800 V | 10 |
| 878-7496 | 2.5mm ² | Black | 800 V | 10 |
| 878-7499 | 2.5mm ² | Blue | 800 V | 10 |
| 913-1207 | 2.5mm ² | Orange | 800 V | 10 |
| 913-1201 | 2.5mm ² | Red | 800 V | 1 |
| 878-7522 | 4mm ² | Blue | 800 V | 10 |
| 878-7528 | 4mm ² | Black | | 10 |
| 878-7525 | 4mm ² | Grey | | 10 |
| 878-7519 | 4mm ² | Grey | 800 V | 10 |
| 913-1210 | 4mm ² | Blue | 800 V | 1 |
| 878-7534 | 6mm ² | Grey | 800 V | 10 |
| 913-1213 | 10mm ² | Grey | 600V | 10 |
| 913-1217 | 16mm ² | Grey | 600V | 10 |

2 Way DIN Rail Earth Block

- Screw connection DIN rail mounted earth terminal blocks
- Green/yellow earth colour coding
- Wires can be connected without any special preparation
- Sold in a Pack of 5



| Stock No. | Block Type | Wire Size | No. of Ways | Termination Method | Pack Size |
|-----------|------------|-------------|-------------|--------------------|-----------|
| 878-7562 | DIN Rail | 26 - 12 AWG | 2 | Screw | 5 |
| 878-7575 | DIN Rail | 26 - 10 AWG | 2 | Screw | 5 |
| 878-7566 | DIN Rail | 26 - 10 AWG | 2 | Screw | 5 |
| 878-7569 | DIN Rail | 26 - 12 AWG | 2 | Screw | 5 |
| 878-7578 | DIN Rail | 26 - 8 AWG | 2 | Screw | 5 |
| 815-773 | Top Hat | 22 - 11 AWG | 2 | Screw Down | 5 |

High Current Terminals (WKN Series)

- Grey screw down termination, single level
- Fingerproof terminals (to VBG4 requirements)
- Flammability rating UL 94-V0
- Sold in a Pack of 5



| | |
|-----------------|------------------------------|
| 384-6988 | 10mm ² , 1kV, 57A |
| 384-6994 | 16mm ² , 1kV, 71A |

High-Power Stud Terminals

- 1000V
- Foot can be snapped on TS 35 DIN rail
- Housing made from polyamide 6.6 UL 94-V0



| | |
|-----------------|----------|
| 872-4824 | 125A M6 |
| 872-4833 | 192A M8 |
| 872-4836 | 269A M10 |
| 872-4849 | 520A M16 |

End Stops/End Brackets

- Provide a secure mechanical stop on DIN rail



501-972 Pack of 10

Screw Down End Stop

- End stops are necessary for preventing movement of components along the rail.
- Depending on the DIN rail, they differ in the dimensions of the mounting foot and their screw-on or snap-on design.
- Material: PA 6.6V2 for TS 32 DIN rail
- Terminal width: 8mm



872-5637 Pack of 10

Modular DIN Rail Mounted Distribution Block

- For control panels and distribution.
- Housing material: Polycarbonate (PC)
- Fixing: On DIN rail conforming to EN 50022 or mounted via fixing screws



868-0736 26 Way, Blue

Test Adaptor

- A test adaptor which enables DIN rail mounted terminals to accept 4mm test leads.
- The adaptor screws into the terminal current bar and projects above the terminal to accept both shrouded and unshrouded 4mm plugs.
- The test adaptor precludes the use of jumper bars and may be permanently fitted to the terminals detailed, enabling easy hands free measurements.
- Voltage and current rating determined by the mating plug.



452-164 Pack of 5

Fuse Kits

- Each fuse kit contains 180 Fuses in a Segmented Flip-Lid Box.
- For easy ordering fuse replacement references on inside lid
- All fuses at a voltage rating of 250V
- 10pcs each current rating



| Stock No. | Size | Voltage Rating |
|-----------|------------|---|
| 893-8537 | 5x20mm | 90 x Slow (0.5A, 1A, 2A, 3.15A, 4A, 5A, 6.3A, 10A and 16A) & 90 x Fast - 250mA, 500mA, 1A, 1.6A, 2A, 3.15A, 5A, 6.3A and 10A |
| 893-8530 | 5x20mm | 90 x Fast Acting (250mA, 500mA, 1A, 1.6A, 2A, 3.15A, 5A, 6.3A, 10A) & 90 x Slow Blow (0.5A, 1A, 1.6A, 2A, 3.15A, 5A, 6.3A, 10A, 16A) |
| 893-8534 | 6.3 x 32mm | 90 x Fast acting (500mA, 1A, 1.6A, 2.5A, 3A, 5A, 6.3A 10A & 16A) & 90 x Slow acting (1A, 1.6A, 2A, 3.15A, 5A, 6.3A, 10A 16A & 20A) |
| 893-8543 | 6.3x32mm | 90 Fast Acting (1A, 2A, 3A, 5A, 6.3A, 10A, 12.5A, 16A, 20A) & 90 Slow Blow (0.63A, 1A, 1.6A, 2A, 5A, 6.3A, 10A, 16A, 20A) |
| 893-8546 | 5x20mm | 60 Fast Acting (500mA, 1A, 2A, 2.5A, 3.15A, 5A), 90 Slow Acting (1A, 1.25A, 1.6A, 2A, 2.5A, 3.15A, 5A, 6.3A, 10A), 30 x 1.0" (25mm) Uk main fuses 3A, 5A, 13A |

Fuse Kit - Mixed Sizes

- Robust case with removable compartments
- 90 fuses of various sizes
- Supplied with:
- 5x20mm T1A, T2A, T3.15, F500mA, F1A, F1.6A, F2A, F2.5A, F3.15A, F4A, F5A, F6.3A, F10A
- 6.3x32mm F1A, F2A, F5A, F10A



918-2697 Fuse Kit - 20mm & 32mm

Fuse Kit - 5x20mm

- Handy compartmented carry case with 22 different fuse types all in 5x20mm size
- HBC in time delay only - 1, 2, 3.15, 5, 10A
- LBC in fast, time delay and semi-delayed



420-268 Fuse Kit - 5x20mm - HBC & LBC

General Purpose Fuse Kit - Mixed

- Kit containing HBC & LBC ceramic fuses in 5x20mm, 1.0" BS1363 (25mm) and 6.3x32mm sizes
- 1.0A to 15A - see online for full kit details



420-252 Fuse Kit - Mixed size

Fuse Kit - 5x20mm

- Assortment of 360 5x20mm fuses with fast, time-delay or semi-timed action
- 18 compartments of 20 fuses
- Values: 100 mA; 125 mA; 160 mA; 200 mA; 250 mA; 315 mA; 400 mA,
- 500 mA; 630 mA; 800 mA; 1 A; 1.25 A; 1.6 A; 2 A; 2.5 A; 3.15 A; 4A; 6.3 A



611-8955 Fuse Kit - 5x20mm

Inspection Joints

- Elbows and Tees in malleable iron with various finishes
- Covers and screws come supplied as standard
- Galvanised steel



763-9210 20mm nominal size, Pack of 5

Coupler

- Galvanised steel coupler for conduit
- Sold in pack of 25



606-030 20mm

606-046 25mm

Reducer Cable Conduit Fitting

- Steel reducer with enamelled finish

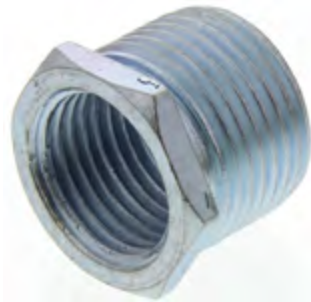

619-979 20/16mm

608-216 25/20mm

Pattern Bush

- Brass



608-244 Long Male Bush, 20mm

619-985 Long Male Bush, 25mm

608-222 Short Male Bush, 20mm

608-238 Short Male Bush, 25mm

Nickel Plated Brass Locknuts

- A selection of 1.5 mm pitch nickel plated brass locknuts
- Metric threads to EN60423
- Complies with EU Directive 2002/95/EC-ROHS
- Complies with EU Directive 2002/96/EU Waste Electrical Equipment-WEEE



127-164 M16 3.5mm

127-489 M25 3.5mm

127-495 M32 5mm

127-473 M20 3.5mm

Galvanised Steel Locknuts

- A selection of 1.5mm pitch steel locknuts
- Suitable for use with all ISO threaded conduit fittings and accessories
- Ideal for general electrical installation



621-102 M16x2.87mm

621-118 M20x2.87mm

Milled Edge Steel Lockring

- Lock Ring
- Steel
- BS EN 50086
- Sold in pack of 50



607-982 20mm, Pack of 50

607-998 25mm, Pack of 50

FACTORY AUTOMATION SENSORS

The range of RS PRO sensors ensures easy configuration and setup.

INDUCTIVE SENSOR: NPN OR PNP?

If your application requires an inductive sensor, you will need to decide what output type you require, NPN or PNP?

NPN Output:

NPN are sinking sensors, these allow current to flow into the sensor and to V-.

With an NPN sensor the switching occurs on the -V rail. The +V rail forms the common between the device and the sensor. A permanent +V supply will be connected to the device that is to be activated, for instance a PLC or relay. When the sensor turns on, it switches the -V rail and completes the circuit. Current travels through the sensor transistor into the device, thus turning it on or changing its state.

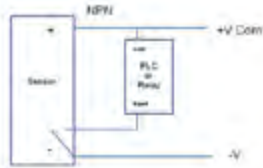

PNP Output:

PNP are sourcing sensors and allow current to flow out from the sensor, from V+.

With a PNP sensor the switching occurs on the +V rail. The -V rail forms the common between the device and the sensor. A permanent -V supply will be connected to the device that is to be activated, for instance a PLC or relay. When the sensor turns on, it switches the +V rail and completes the circuit. Current travels through the sensor transistor into the device, thus turning it on or changing its state.

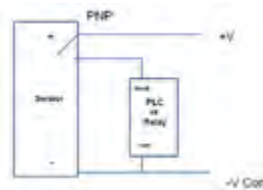

Remember

- If the DC voltage has a V+ common, an NPN output sensor is needed. If the DC voltage has a V- common, a PNP output sensor is needed.
- NPN or PNP output does not have correlation to whether the sensor is NO (normally open) or NC (normally closed) as both NPN and PNP can be either NO or NC.

Sensor Tester

- Handy battery powered proximity sensor tester ideal for checking 3 / 4 wire DC sensors while in place
- Supports NPN & PNP variants
- Supplied with batteries ready to use



Image for illustrative purposes only

839-9875 Proximity Switch LED and Audio

Barcode Scanner

- Ergonomic design to fit comfortably in the hand
- Can switch between automatic scanning or manual scanning via the trigger
- Perfect for scanning both physical labels and digital barcodes
- 360° scan angle ensuring quick and easy scanning
- 3 mil recognition accuracy
- USB interface allowing for quick and easy operation

**IP54
RATED**



206-7501 USB

Load Cell Sensors

- Load cells, often called load cell transducers, are crucial components in most industrial weighing systems. They are available in many different configurations and standards, depending on the intended application and environment.
- Among the various different types of load cells available, models and styles can be differentiated in two key ways: By the specific method they use to detect weight (compression load cells, tension load cells and other measurement types) or by the type of output signal generated (hydraulic load cells, piezoelectric load cells and various other configurations).



Image for illustrative purposes only

| Stock No. | Force Measured | Measurement Range Min/max | Output Type | IP Rating | Max Voltage |
|-----------|-----------------------|---------------------------|-------------|-----------|-------------|
| 204-2767 | Compression | 0.3 - 3kg | PNP | IP67 | 15V |
| 204-2772 | Compression | | PNP | IP66 | 10V |
| 204-2765 | Compression | 5 - 500kg | PNP | IP68 | 15V |
| 204-2770 | Compression | 10 - 100kg | PNP | IP67 | 15V |
| 204-2768 | Compression | 50 - 1000kg | PNP | IP66 | 15V |
| 204-2764 | Compression | 50 - 1000kg | PNP | IP68 | 10V |
| 204-2771 | Compression | 60 - 1200kg | PNP | IP67 | 15V |
| 204-2766 | Compression | 500 - 3000kg | PNP | IP68 | 15V |
| 204-2773 | Compression & Tension | 1 - 500kg | PNP | IP66 | 10V |

Fibre Optic Sensors

- Fibre optic sensor with NPN output.
- Fibre optic sensors are a type of proximity sensor that has an optical fibre connected to a light source to allow for detection in tight spaces or where a small profile is beneficial.
- The optical fibre is a transparent fibre made of glass (silica) or plastic with a diameter slightly thicker than a human hair, this fibre transmits light between the two ends to produce an electrical signal.
- Compatible probes 896-7298 and 896-7285



| Stock No. | Housing Material | Output Type | Supply Voltage | IP Rating |
|-----------|------------------|-------------|----------------|-----------|
| 204-0681 | Plastic | NPN | 24V DC | IP54 |
| 204-0682 | Plastic | PNP | 24V DC | IP54 |

Inductive Sensors for Flush Mount

- Inductive sensors offer precise detection, long-term reliability and high accuracy
- The sensors are completely encapsulated, which greatly increases shock and vibration resistance and are flush mounted



Image for illustrative purposes only

IP67 RATED

| Stock No. | Detection Range | Output Type | Housing Material | Terminal Type | Thread Size |
|-----------|-----------------|-------------|---------------------|---------------|-------------|
| 206-6124 | 0.6mm | PNP NO | Stainless Steel | 2m Cable | M4x0.5 |
| 206-6126 | 0.8mm | PNP NO | Stainless Steel | M8 | M5x0.5 |
| 206-6127 | 0.8mm | PNP NO | Stainless Steel | 2m Cable | M5x0.5 |
| 206-6128 | 1.5mm | PNP NO | Stainless Steel | M8 | M5x0.5 |
| 206-6129 | 1.5mm | PNP NO | Stainless Steel | 2m Cable | M5x0.5 |
| 206-6150 | 2mm | PNP NO | Brass Nickel Plated | M8 | M8x1 |
| 206-6151 | 2mm | PNP NO | Brass Nickel Plated | M8 | M8x1 |
| 206-6152 | 2mm | PNP NO | Brass Nickel Plated | 2m Cable | M8x1 |
| 206-6154 | 2mm | PNP NO | Brass Nickel Plated | 2m Cable | M8x1 |
| 206-6155 | 4mm | PNP NO | Brass Nickel Plated | M12 | M12x1 |
| 206-6156 | 4mm | PNP NO | Brass Nickel Plated | M12 | M12x1 |
| 206-6157 | 4mm | PNP NO | Brass Nickel Plated | 2m Cable | M12x1 |
| 206-6162 | 8mm | PNP NO | Brass Nickel Plated | M12 | M18x1 |
| 206-6158 | 8mm | NPN NO | Brass Nickel Plated | 2m Cable | M12x1 |
| 206-6159 | 8mm | PNP NO | Brass Nickel Plated | M12 | M12x1 |
| 206-6160 | 8mm | PNP NO | Brass Nickel Plated | 2m Cable | M12x1 |
| 206-6161 | 8mm | PNP NO | Brass Nickel Plated | M12 | M18x1 |
| 206-6163 | 8mm | PNP NO | Brass Nickel Plated | 2m Cable | M18x1 |
| 206-6165 | 10mm | PNP NC | Brass Nickel Plated | 2m Cable | M30x1.5 |
| 206-6164 | 20mm | PNP NO | Brass Nickel Plated | M12 | M18x1 |
| 206-6166 | 38mm | PNP NO | Brass Nickel Plated | M12 | M30x1.5 |
| 206-6167 | 38mm | PNP NO | Brass Nickel Plated | 2m Cable | M30x1.5 |
| 206-6168 | 2mm | PNP NO | Plastic Vistal® | M8 | - |
| 206-6170 | 2mm | PNP NO | Plastic Vistal® | 2m Cable | - |
| 206-6171 | 3mm | PNP NO | Plastic Vistal® | M8 | - |
| 206-6172 | 3mm | PNP NO | Plastic Vistal® | 2m Cable | - |
| 206-6173 | 4mm | PNP NO | Plastic Vistal® | M8 | - |
| 206-6174 | 4mm | PNP NO | Plastic Vistal® | 2m Cable | - |
| 206-6176 | 20mm | PNP NO/NC | Plastic PA 66 | M12 | - |
| 206-6177 | 20mm | PNP NO/NC | Plastic PA 66 | Terminal | - |
| 206-6178 | 20mm | PNP NO | Plastic PA 66 | M12 | - |
| 206-6179 | 20mm | PNP NO | Plastic PA 66 | Terminal | - |
| 206-6180 | 40mm | PNP NO/NC | Plastic PA 66 | M12 | - |
| 206-6181 | 40mm | PNP NO/NC | Plastic PA 66 | Terminal | - |
| 206-6182 | 40mm | PNP NO | Plastic PA 66 | M12 | - |
| 206-6183 | 40mm | PNP NO | Plastic PA 66 | Terminal | - |

Proximity Photoelectric Sensors

Photoelectric sensors detect and measure physical objects or quantities by emitting a field or beam of electromagnetic radiation. An object is detected by measuring alterations in the return signal.

Through-beam sensors rely on two separate housings, one for the transmitter and one for the receiver. Retro-reflective photoelectric sensors have both the transmitter and receiver contained within the same housing but require a reflector opposite to the sensor. Diffuse sensors are easier to install as only one device has to be mounted. This is because the transmitter and receiver are contained within one housing.

APPLICATIONS

- Industrial Factories
- Distribution Warehouses
- Food and Beverage
- Automation
- Building Maintenance

MAIN ADVANTAGES

The basic function is to detect the presence or absence of objects or measure the distance to the object, there are 3 main types of photoelectric sensors which provide reliable detection, these are through-beam, retro-reflective and diffuse.

DETECTION TYPES

Diffuser Reflection sensors use reflection to detect the presence of objects. The sensor emits a light that is reflected by the object. The reflected light is detected by the sensor and the sensor switches.

Diffuse Reflection with background suppression Many diffuse reflection sensors come with background suppression that prevents faulty triggering caused by reflections in the environment.

Retro Reflection sensors contain the transmitter and receiver in one housing and are combined with a prismatic reflector. This reflector reflects the emitted light beam and if the light is interrupted by an object, the sensor switches. A polarisation filter prevents faulty switching caused by reflective surfaces in the environment.

Retro Reflection with polarisation filter Retro-reflection sensors with a polarisation filter prevent faulty switching caused by reflective surfaces in the environment. Dedicated reflectors are needed to turn the light beam, so it can be detected by the sensor.

Through Beam With Through Beam sensors, the transmitter and receiver are in two separate devices positioned directly opposite each other. The transmitter continuously sends light to the receiver. The receiver switches as soon as the light beam is disconnected by an object. Through beam sensors are more resistant to malfunctioning and offer very high sensing ranges.

Diffuse Reflection

- Uses the diffuse-reflective principle to detect the absence or the presence of an object by picking up the reflected infrared light energy from the object.
- Offers excellent anti-interference performance, along with high detection accuracy, ensuring confidence and reliability.
- Designed to be highly sensitive with high linearity and pinpoint accuracy for optimum performance with the reflector and receiver in one convenient housing.



**IP67
RATED**

| Stock No. | Housing Material | Detection Range (mm) | Terminal Type | Output Type | Thread Size |
|-----------|---------------------|----------------------|---------------|-------------|-------------|
| 204-3961 | Brass Nickel Plated | 150 | 2m Cable | NPN NO | M12x1 |
| 204-3962 | Brass Nickel Plated | 150 | 2m Cable | PNP NO | M12x1 |
| 204-3963 | Brass Nickel Plated | 150 | M12 | NPN NO | M12x1 |
| 204-3965 | Brass Nickel Plated | 150 | M12 | PNP NO | M12x1 |
| 204-3966 | PBT | 150 | 2m Cable | NPN NO | M12x1 |
| 204-3967 | PBT | 150 | 2m Cable | PNP NO | M12x1 |
| 204-3968 | Brass Nickel Plated | 400 | 2m Cable | NPN NO/NC | M18x1 |
| 204-3970 | Brass Nickel Plated | 400 | M12 | NPN NO/NC | M18x1 |
| 204-3969 | Brass Nickel Plated | 400 | 2m Cable | PNP NO/NC | M18x1 |
| 204-3971 | Brass Nickel Plated | 400 | M12 | PNP NO/NC | M18x1 |
| 204-3972 | PBT | 400 | 2m Cable | NPN NO/NC | M18x1 |
| 204-3973 | PBT | 400 | 2m Cable | PNP NO/NC | M18x1 |
| 204-3974 | PBT | 400 | M12 | NPN NO/NC | M18x1 |
| 204-3975 | PBT | 400 | M12 | PNP NO/NC | M18x1 |
| 204-3976 | Brass Nickel Plated | 1000 | 2m Cable | NPN NO/NC | M30x1.5 |
| 204-3977 | Brass Nickel Plated | 1000 | 2m Cable | PNP NO/NC | M30x1.5 |
| 204-3979 | PBT | 1000 | 2m Cable | PNP NO/NC | M30x1.5 |

Background Suppression M18x0

- Uses the background suppression (BGS) sensor principle to detect the absence or the presence of an object, making it ideal for use on conveyor belts
- This method of detection prevents any background object, for example, the conveyor belt, beyond a set distance from being detected
- The sensor offers excellent anti-interference performance, along with high detection accuracy, ensuring confidence and reliability



**IP67
RATED**

Image for illustrative purposes only

| Stock No. | Housing Material | Detection Range (mm) | Terminal Type | Output Type |
|-----------|---------------------|----------------------|---------------|-------------|
| 204-4013 | Brass Nickel Plated | 1000 | 2m Cable | PNP NO/NC |
| 204-4014 | Brass Nickel Plated | 1000 | 2m Cable | NPN NO/NC |
| 204-4015 | Brass Nickel Plated | 1000 | M12 | PNP NO/NC |
| 204-4016 | Brass Nickel Plated | 1000 | M12 | NPN NO/NC |

Through Beam Emitter / Receiver

- Uses the through-beam sensor principle to detect the absence or the presence of an object
- The emitter and receiver are installed opposite each other so that it enables the light beam from the emitter to access the receiver, meaning when a passing object interrupts the light source between the two parts, it reduces the amount of light that is detected by the receiver
- The sensor offers excellent anti-interference performance, along with high detection accuracy, ensuring confidence and reliability



**IP67
RATED**

Image for illustrative purposes only

| Stock No. | Detection Type | Housing Material | Detection Range (mm) | Terminal Type | Output Type | Thread Size |
|-----------|-------------------------|---------------------|----------------------|---------------|-------------|-------------|
| 204-3990 | Through Beam (Emitter) | Brass Nickel Plated | 5000 | 2m Cable | - | M12x1 |
| 204-3991 | Through Beam (Receiver) | Brass Nickel Plated | 5000 | 2m Cable | NPN NO | M12x1 |
| 204-3993 | Through Beam (Receiver) | Brass Nickel Plated | 5000 | 2m Cable | PNP NO | M12x1 |
| 204-3994 | Through Beam (Emitter) | Brass Nickel Plated | 10000 | 2m Cable | - | M18x1 |
| 204-3995 | Through Beam (Receiver) | Brass Nickel Plated | 10000 | 2m Cable | NPN NO/NC | M18x1 |
| 204-4000 | Through Beam (Receiver) | PBT | 10000 | 2m Cable | - | M18x1 |
| 204-4001 | Through Beam (Emitter) | PBT | 10000 | 2m Cable | NPN NO/NC | M18x1 |
| 204-3996 | Through Beam (Receiver) | Brass Nickel Plated | 10000 | 2m Cable | PNP NO/NC | M18x1 |
| 204-3997 | Through Beam (Receiver) | Brass Nickel Plated | 20000 | 2m Cable | - | M18x1 |
| 204-3998 | Through Beam (Emitter) | Brass Nickel Plated | 20000 | 2m Cable | NPN NO/NC | M18x1 |
| 204-3999 | Through Beam (Receiver) | Brass Nickel Plated | 20000 | 2m Cable | PNP NO/NC | M18x1 |
| 204-4003 | Through Beam (Receiver) | PBT | 10000 | 2m Cable | PNP NO/NC | M18x1 |
| 204-4004 | Through Beam (Emitter) | PBT | 20000 | 2m Cable | - | M18x1 |
| 204-4005 | Through Beam (Receiver) | PBT | 20000 | 2m Cable | NPN NO/NC | M18x1 |
| 204-4006 | Through Beam (Receiver) | PBT | 20000 | 2m Cable | PNP NO/NC | M18x1 |
| 204-4007 | Through Beam (Emitter) | Brass Nickel Plated | 20000 | 2m Cable | - | M30x1.5 |
| 204-4009 | Through Beam (Receiver) | Brass Nickel Plated | 20000 | 2m Cable | PNP NO/NC | M30x1.5 |
| 204-4010 | Through Beam (Emitter) | PBT | 20000 | 2m Cable | - | M30x1.5 |
| 204-4011 | Through Beam (Receiver) | PBT | 20000 | 2m Cable | NPN NO/NC | M30x1.5 |
| 204-4012 | Through Beam (Receiver) | PBT | 20000 | 2m Cable | PNP NO/NC | M30x1.5 |

Diffuse Reflection with Background Suppression

- Many diffuse reflection sensors come with background suppression that prevents faulty triggering caused by reflections in the environment.



IP67 RATED

| Stock No. | Detection Range (mm) | Output Type | Terminal Type |
|-----------|----------------------|-------------|---------------|
| 202-4470 | 100 | PNP NO/NC | 2m Cable |
| 202-4471 | 100 | PNP NO/NC | M12 |
| 202-4448 | 350 | NPN NO/NC | 2m Cable |
| 202-4449 | 350 | NPN NO/NC | M8 |
| 202-4450 | 350 | PNP NO/NC | 2m Cable |
| 202-4451 | 350 | PNP NO/NC | M8 |

Diffuse Reflection

- Universal housing, an ideal replacement for a wide range of sensor types
- IP67, suitable for harsh environments
- One-click distance setting, accurate and fast
- Suitable for the detection of high light objects and some transparent objects
- NO and NC are switchable
- Electrical Connection: PVC cable or M8 Connector



IP67 RATED

| Stock No. | Detection Range (mm) | Terminal Type | Output Type | Thread Size |
|-----------|----------------------|---------------|-------------|-------------|
| 202-4428 | 100 | 2m Cable | NPN | - |
| 202-4429 | 100 | M8 | NPN | - |
| 202-4431 | 100 | 2m Cable | PNP | - |
| 202-4432 | 100 | M8 | PNP | - |
| 202-4433 | 300 | 2m Cable | NPN NO/NC | - |
| 202-4434 | 300 | M8 | NPN NO/NC | - |
| 202-4435 | 300 | 2m Cable | PNP NO/NC | - |
| 202-4436 | 300 | M8 | PNP NO/NC | - |
| 202-4453 | 300 | 2m Cable | NPN NO/NC | M18x1 |
| 202-4454 | 300 | M12 | NPN NO/NC | M18x1 |
| 202-4455 | 300 | 2m Cable | PNP NO/NC | M18x1 |
| 202-4456 | 300 | M12 | PNP NO/NC | M18x1 |
| 202-4476 | 300 | 2m Cable | Relay NO/NC | - |
| 202-4424 | 1000 | 2m Cable | NPN | - |
| 202-4425 | 1000 | M8 | NPN | - |
| 202-4426 | 1000 | 2m Cable | PNP | - |
| 202-4427 | 1000 | M8 | PNP | - |
| 202-4472 | 2000 | 2m Cable | PNP+NPN | - |
| 202-4473 | 2000 | M12 | PNP+NPN | - |
| 202-4475 | 2000 | 2m Cable | Relay NO/NC | - |

Diffuse Reflection with Terminal Chamber

- Diffused detection sensor for enhanced reliability and precision
- Reliably detect multiple colours and objects with accuracy
- Robust, all in one design with emitter and receiver built into single housing for easy installation in a wide range of environments
- Anti-interference offering excellent performance



IP67 RATED

| Stock No. | Detection Type | Detection Range (mm) | Output Type |
|-----------|----------------|----------------------|-------------|
| 202-5452 | Diffuse | 800 | Relay |
| 202-5448 | Diffuse | 2000 | NO+NC, NPN |
| 202-5450 | Diffuse | 2000 | NO+NC, PNP |
| 202-5451 | Diffuse | 2000 | Relay |

Through Beam with Terminal Chamber

- Through beam detection sensor ideal for detecting objects at a distance
- Long sensing distance of 30m
- Relay output
- Infrared LED (880nm) light source
- Terminal connections
- High detection accuracy
- Special on-delay and off-delay function
- IP67 protection offering protection against dust and moisture build up
- Robust design ideal for use in a wide range of environments
- Anti-interference offering excellent performance



IP67 RATED

| Stock No. | Detection Type | Detection Range (mm) | Output Type |
|-----------|-------------------------|----------------------|-------------|
| 202-5462 | Through Beam (Receiver) | 30000 | Relay |
| 202-5460 | Through Beam (Emitter) | 30000 | Relay |

Retro Reflection with Polarisation Filter

- Polarized reflection sensor for enhanced reliability and precision
- Red light light source
- NO/NC Output is switchable
- Reliably detect high light options and even some transparent objects with accuracy
- Anti-sunlight interference offering excellent performance



IP67 RATED

| Stock No. | Detection Range (mm) | Terminal Type | Output Type |
|-----------|----------------------|---------------|-------------|
| 201-8160 | 3000 | 2m Cable | NPN NO/NC |
| 201-8161 | 3000 | M8 | NPN NO/NC |
| 201-8162 | 3000 | 2m Cable | PNP NO/NC |
| 201-8163 | 3000 | M8 | PNP NO/NC |

Through Beam

- Economical and reliable compact devices essential for industrial environments such as conveyor belts in manufacturing plants.



**IP67
RATED**

| Stock No. | Detection Type | Detection Range (mm) | Terminal Type | Output Type |
|-----------|-------------------------|----------------------|---------------|-------------|
| 202-4442 | Through Beam (Receiver) | 10000 | M8 | NPN NO/NC |
| 202-4443 | Through Beam (Receiver) | 10000 | 2m Cable | PNP NO/NC |
| 202-4444 | Through Beam (Receiver) | 10000 | M8 | PNP NO/NC |
| 202-4445 | Through Beam (Emitter) | 10000 | 2m Cable | - |
| 202-4447 | Through Beam (Emitter) | 10000 | M8 | - |
| 202-4461 | Through Beam (Emitter) | 20000 | 2m Cable | - |
| 202-4463 | Through Beam (Receiver) | 20000 | 2m Cable | NPN NO/NC |
| 202-4465 | Through Beam (Receiver) | 20000 | 2m Cable | PNP NO/NC |
| 202-4462 | Through Beam (Emitter) | 20000 | M12 | - |
| 202-4464 | Through Beam (Receiver) | 20000 | M12 | NPN NO/NC |
| 202-4466 | Through Beam (Receiver) | 20000 | M12 | PNP NO/NC |
| 202-4482 | Through Beam (Emitter) | 60000 | 2m Cable | - |
| 202-4483 | Through Beam (Receiver) | 60000 | 2m Cable | Relay NO/NC |

Retro Reflection with Polarisation Filter

- Suitable for the detection of high light objects and some transparent objects
- Electrical Connection: 2 m PVC cable or M12 Connector
- 360° LED status indicator
- Visible light spot for easy installation
- One-click distance setting, accurate and fast



**IP67
RATED**

Retro Reflection

- Retroreflective detection sensor ideal for detecting transparent objects
- All in one design with emitter and receiver built into single housing for easy installation
- Wide sensing distance of 5m to detect objects at a distance

**IP67
RATED**

| Stock No. | Detection Type | Detection Range (mm) | Terminal Type | Output Type |
|-----------|----------------------|----------------------|---------------|-------------|
| 202-4458 | Polarised Reflection | 3000 | M12 | NPN NO/NC |
| 202-4459 | Polarised Reflection | 3000 | 2m Cable | PNP NO/NC |
| 202-4460 | Polarised Reflection | 3000 | M12 | PNP NO/NC |
| 202-4437 | Polarised Reflection | 4000 | M8 | NPN NO/NC |
| 202-4438 | Polarised Reflection | 4000 | 2m Cable | NPN NO/NC |
| 202-4439 | Polarised Reflection | 4000 | 2m Cable | PNP NO/NC |
| 202-4478 | Polarised Reflection | 5000 | M12 | PNP+NPN |
| 202-4481 | Polarised Reflection | 5000 | M12 | Relay NO/NC |
| 202-5457 | Polarised Reflection | 12000 | Terminal | NPN NO/NC |
| 202-5458 | Polarised Reflection | 12000 | Terminal | PNP NO/NC |
| 202-5459 | Polarised Reflection | 12000 | Terminal | Relay NO/NC |
| 202-4440 | Polarised Reflection | 4000 | M8 | PNP NO/NC |
| 202-4477 | Polarised Reflection | 5000 | 2m Cable | PNP+NPN |
| 202-4479 | Polarised Reflection | 5000 | 2m Cable | Relay NO/NC |



| Stock No. | Detection Type | Detection Range (mm) | Output Type |
|-----------|------------------|----------------------|-------------|
| 202-5454 | Retro-reflection | 5000 | NC, PNP |
| 202-5456 | Retro-reflection | 5000 | Relay |
| 202-5453 | Retro-reflection | 5000 | NC, NPN |

PROXIMITY CAPACITIVE SENSORS

Capacitive proximity sensors feature a pair of parallel plates, similar to a standard capacitor. They work when an object produces changes in capacitance, triggering the sensor. Capacitive sensors are designed for use with non-ferrous materials and are ideal for close-range applications such as level detection and monitoring.

Capacitive sensors can be affected by their environment and possible interaction with other sensors. This could include anything from the ambient temperature to other objects in the vicinity. As a result of this, precautions should be taken when installing these sensors to avoid interference from other objects or sensors.

APPLICATIONS

Applications including flow control for detection of liquids, grains and powders. Common applications include the food and beverage industry, robotics, machine tools, packaging and materials handling.

MAIN ADVANTAGES

Proximity capacitive sensor can detect both metal and non-metal materials, especially suitable for detecting materials such as plastics, tank liquid level detection, hopper powders and particles. Ideal for sight glass monitoring.

Pipeline Mount

- This capacitive sensor can detect both metal and non-metal objects
- It also has the ability to detect various media via non-metallic containers
- They provide reliable and accurate liquid level detection
- Provides a lower-cost solution for proximity sensor needs whilst featuring good resolution, stability, high speed and low power usage



| Stock No. | Pipe | OD / Wall Thickness | Terminal Type | Output Type |
|-----------|-----------|---------------------|---------------|-------------|
| 184-5575 | Non Metal | 12-26mm / <1mm | 2m Cable | NPN-NO |
| 184-5576 | Non Metal | 12-26mm / <1mm | 2m Cable | PNP-NO |
| 184-5572 | Non Metal | 8-11mm / ≤1mm | 2m Cable | NPN-NO |
| 184-5574 | Non Metal | 8-11mm / ≤1mm | 2m Cable | PNP-NO |

Flush Mount Proximity Capacitive Sensors

- Can detect both metal and non-metal objects
- Has the ability to detect various media via non-metallic containers

**IP67
RATED**



Image for illustrative purposes only

| Stock No. | Housing Style | Detection Range (mm) | Terminal Type | Output Type |
|-----------|---------------|----------------------|---------------|-------------|
| 184-5578 | M12x1 | 2 | 2m Cable | NPN-NO |
| 184-5582 | M12x1 | 2 | 2m Cable | NPN-NO |
| 184-5584 | M12x1 | 2 | 2m Cable | PNP-NO |
| 184-5579 | M12x1 | 2 | M12 | NPN-NO |
| 184-5583 | M12x1 | 2 | M12 | NPN-NO |
| 184-5585 | M12x1 | 2 | M12 | PNP-NO |
| 184-5569 | - | 5 | 2m Cable | NPN-NO |
| 184-5570 | - | 5 | 2m Cable | PNP-NO |
| 184-5593 | M18x1 | 5 | 2m Cable | NPN-NO/NC |
| 184-5604 | M18x1 | 5 | 2m Cable | NPN-NO/NC |
| 184-5596 | M18x1 | 5 | 2m Cable | PNP-NO/NC |
| 184-5606 | M18x1 | 5 | 2m Cable | PNP-NO/NC |
| 184-5591 | M18x1 | 5 | 2m Cable | NO |
| 184-5594 | M18x1 | 5 | M12 | NPN-NO/NC |
| 184-5605 | M18x1 | 5 | M12 | NPN-NO/NC |
| 184-5607 | M18x1 | 5 | M12 | PNP-NO/NC |
| 184-5592 | M18x1 | 5 | M12 | NO |
| 184-5603 | M18x1 | 5 | M12 | NO |
| 184-5615 | M30x1,5 | 10 | 2m Cable | NPN-NO/NC |
| 184-5617 | M30x1,5 | 10 | 2m Cable | PNP-NO/NC |
| 184-5632 | M30x1,5 | 10 | 2m Cable | PNP-NO/NC |
| 184-5613 | M30x1,5 | 10 | 2m Cable | NO |
| 184-5627 | M30x1,5 | 10 | 2m Cable | NO |
| 184-5634 | M30x1,5 | 10 | 2m Cable | NO |
| 184-5616 | M30x1,5 | 10 | M12 | NPN-NO/NC |
| 184-5631 | M30x1,5 | 10 | M12 | NPN-NO/NC |
| 184-5633 | M30x1,5 | 10 | M12 | PNP-NO |
| 184-5619 | M30x1,5 | 10 | M12 | PNP-NO/NC |
| 184-5614 | M30x1,5 | 10 | M12 | NO |
| 184-5628 | M30x1,5 | 10 | M12 | NO |
| 184-5635 | M30x1,5 | 10 | M12 | NO |
| 184-5629 | M30x1,5 | 15 | 2m Cable | NPN-NO/NC |

Non-flush Mount Proximity Capacitive Sensors

- This capacitive sensor can detect both metal and non-metal objects
- It also has the ability to detect various media via non-metallic containers
- They provide reliable and accurate liquid level detection
- Provides a lower-cost solution for proximity sensor needs whilst featuring good resolution, stability, high speed and low power usage
- Each sensor has a simple in construction and is adjustable
- They can be used for the measurement of force, pressure and humidity, etc. and they have a higher sensitivity and can be operational with small magnitude of force
- Capacitive proximity sensing offers increased usability, improved industrial design, and increased functionality with many different consumer applications

**IP67
RATED**



Image for illustrative purposes only

| Stock No. | Housing Style | Detection Range (mm) | Terminal Type | Output Type |
|-----------|---------------|----------------------|---------------|-------------|
| 184-5580 | M12x1 | 4 | 2m Cable | NPN-NO |
| 184-5586 | M12x1 | 4 | 2m Cable | NPN-NO |
| 184-5588 | M12x1 | 4 | 2m Cable | PNP-NO |
| 184-5581 | M12x1 | 4 | M12 | NPN-NO |
| 184-5587 | M12x1 | 4 | M12 | NPN-NO |
| 184-5590 | M12x1 | 4 | M12 | PNP-NO |
| 184-5571 | - | 8 | M12 | NPN-NO |
| 184-5599 | M18x1 | 8 | 2m Cable | NPN-NO/NC |
| 184-5609 | M18x1 | 8 | 2m Cable | NPN-NO/NC |
| 184-5611 | M18x1 | 8 | 2m Cable | PNP-NO/NC |
| 184-5597 | M18x1 | 8 | 2m Cable | NO |
| 184-5600 | M18x1 | 8 | M12 | NPN-NO/NC |
| 184-5610 | M18x1 | 8 | M12 | NPN-NO/NC |
| 184-5601 | M18x1 | 8 | M12 | PNP-NO/NC |
| 184-5612 | M18x1 | 8 | M12 | PNP-NO/NC |
| 184-5598 | M18x1 | 8 | M12 | NO |
| 184-5608 | M18x1 | 8 | M12 | NO |
| 184-5577 | - | 10 | 2m Cable | NPN-NO |
| 184-5622 | M30x1,5 | 15 | 2m Cable | NPN-NO/NC |
| 184-5638 | M30x1,5 | 15 | 2m Cable | NPN-NO/NC |
| 184-5625 | M30x1,5 | 15 | 2m Cable | PNP-NO/NC |
| 184-5640 | M30x1,5 | 15 | 2m Cable | PNP-NO/NC |
| 184-5620 | M30x1,5 | 15 | 2m Cable | NO |
| 184-5636 | M30x1,5 | 15 | 2m Cable | NO |
| 184-5623 | M30x1,5 | 15 | M12 | NPN-NO/NC |
| 184-5639 | M30x1,5 | 15 | M12 | NPN-NO/NC |
| 184-5626 | M30x1,5 | 15 | M12 | PNP-NO/NC |
| 184-5641 | M30x1,5 | 15 | M12 | PNP-NO/NC |
| 184-5621 | M30x1,5 | 15 | M12 | NO |
| 184-5637 | M30x1,5 | 15 | M12 | NO |
| 184-5642 | M30x1,5 | 15 | M12 | NO |

Open End Sensor Cables

- Introducing the range of RS PRO Cables, ideal for use with industrial sensor and automation equipment.
- This cable has been designed with a secure coupling nut and a partially stripped free end connection on the other side, allowing complete flexibility for connection.
- The 20 m PUR multi-strand cable is ultra-durable, protecting the internal wires, and easy to install, making it an ideal solution where secure and reliable data transference is required.



| Stock No. | Body Orientation | Connection A | | Connection B | | Cable Length |
|-----------|------------------|--------------|-----------------|--------------|-----------------|--------------|
| | | Gender | Connection Size | Gender | Connection Size | |
| 205-5980 | Angled | Female | M12 | - | Open End | 15m |
| 205-5993 | Angled | Female | M12 | - | Open End | 20m |
| 205-5992 | Straight | Female | M12 | - | Open End | 10m |
| 205-5987 | Straight | Male | M8 | - | Open End | 10m |

Panel Mount Sensor Cables

- Ideal for panel mounting in production and manufacturing environments.
- The partially stripped free end connections allow complete flexibility for connection.



| Stock No. | Type | Gender | Connection Size | No of contacts |
|-----------|--------------------|--------|-----------------|----------------|
| 205-5976 | Circular Connector | Female | M12 | 4 |
| 205-5974 | Circular Connector | Female | M12 | 5 |
| 205-5982 | Circular Connector | Male | M12 | 4 |
| 205-5991 | Circular Connector | Male | M12 | 4 |
| 205-5978 | Circular Connector | Male | M12 | 5 |

Adjustable Mounting Brackets

- Zinc Plated Steel Bar and Nylon Clamping Parts



| Stock No. | Type | Suitable for Sensors |
|-----------|--------------------------|---------------------------|
| 256-001 | Panel Mount | M4, M5, M8, M12, M14, M18 |
| 256-017 | Panel Mount | M30 |
| 714-1697 | Rail Mount (Ø 8 or 12mm) | M4, M5, M8, M12, M14, M18 |

Sensor Mounting Brackets

- Material: Steel, zinc coated
- Multiple mounting options
- Right-angled
- Fast installation
- M8 to M30 fittings
- Compatible with Inductive Proximity Sensor



| Stock No. | Dimensions | Suitable for Sensors |
|-----------|------------------|----------------------|
| 213-3660 | 30 x 30 x 26.5mm | M12 |
| 213-3661 | 30 x 30 x 26.5mm | M8 |
| 213-3662 | 60 x 42 x 55mm | M30 |
| 213-3659 | 42 x 37 x 36.5mm | M18 |

TOOLS & CONSUMABLES

The RS PRO range includes tough, industrial grade tools, kits and cabinets - all the tools an electrical engineer or maintainer may need.

Stainless Steel Screw/Bolt, Nut & Washer Kit

- This RS A2 Stainless Steel Torx Kit contains 2,375 A2 stainless steel security torx head screws in a range of metric thread sizes from M3 through to M6 size.



819-9004 2475 pieces

LED Head Torch

- With 6 light settings, in a water and impact resistant case
- Uses 3xAAA batteries (included)



200-6746 350lm

UV LED Torch

- Flood to spot beam twist zoom
- 1m impact-resistant
- IPX4 water-resistant



220-6819 Red 2.7 lm, 147 mm

**IPX4
RATED**

LED Torch

- The anti-roll body ensures that Torch securely stays in 1 position rather than rolling off the surface.
- Twist flood to spot beam control, that allows users to either create a long-range light or a more focused circular beam of light or create a wide pattern of light.
- A tactical rubberised switch
- The nylon wrist strap prevents the user from accidentally dropping the torch.



176-6034 1400 lumen

Aluminium LED Torch

- Long life LED lamp
- Luminosity of 600 lm
- Easy to adjust beam
- 3 beam settings - high, low and strobe
- Not rechargeable
- Four AAA batteries included



196-4195 250 lm, 150 mm

196-4196 600 lm, 163 mm

LED Pen Torch

- Compact penlight torch uses an extra strong CREE XPG LED to offer a bright light with an easy twist flood-to-spot feature for closer lighting inspection
- IP56 water resistant and up to 1 m impact resistant, making it suitable for harsh environments like worksites



200-6747 180 lm, 150 mm

YOUR SMART CHOICE FOR FACILITIES MAINTENANCE

We provide everything you need to keep your facilities safe and secure and to protect people at work. And then brooms, mops, buckets, vacuum cleaners, soap dispensers, sanitiser stations, paper towels, hand dryers and high-quality smart temperature monitors for access control - both to buildings and open environments. And let's not forget hygiene and cleaning, an important part of safety!



Visit rspro.com to browse our Facilities Maintenance Range Guide



**Electrician's Tool Kit
32 Piece**

- Ergonomic multi-component handles
- Optimum balance of torque and control
- High quality
- VDE approved for electrical safety
- Tool storage - comes in a sturdy tool bag



136-3411 32 Piece Electricians Tool Kit with Case

Kit contains

- | | |
|---|--|
| <ul style="list-style-type: none"> 01 Wallboard Saw - 160 mm 02 Safety Goggles 03 Compact Tape Measure - 3x16 mm / 10 ft 04 Claw Hammer - 16 oz. 05 Flat Cold Chisel - 16x150/20x175mm 06 Hacksaw (in-Handle Fixing System) 07 Mini Hacksaw 08 Automatic Wire Stripper 09 Trimming Knife 10 Professional LED Flashlight 11 Marker Pen 12 Single-Pole Voltage Tester (Short) 13 Electronics Slotted Screwdriver - 3x80 mm | <ul style="list-style-type: none"> 14 Slotted Screwdriver (Flared Tip) - 10.0x200 mm 15 150 mm Screw Gripping Screwdriver 16 Stubby Slotted Screwdriver - 5.5x25 mm 17 Stubby Pozidriv Screwdriver - PZ2x25 mm 18 Insulated Pozidriv Screwdriver (VDE) - PZ1x80/PZ2x100 mm 19 Insulated Slotted Screwdriver (VDE) - 2.5x 75 / 4.0x100 mm 20 Long Nose Pliers - 160 mm 21 Diagonal Cutter - 160 mm 22 Combination Pliers - 200 mm 23 RZR Series Cable Shears - 170 mm 24 Multi-Purpose Cutter (Straight) 25 Adjustable Wrench (Phosphate/PVC) - 200 mm 26 Water Pump Pliers (Box Joint/PVC) - 250 mm Water Pump Pliers (Box Joint/PVC) - 300 mm |
|---|--|

VDE Tool Kit

- Designed for professional engineers who work on or around electrically live circuits
- All tools are VDE certified and individually tested for use up to 100V AC



829-6549 24-piece

**Electricians Tool Kit
36 Piece**

- Ergonomic multi-component handles
- Optimum balance of torque and control
- High quality
- VDE approved screwdrivers and pliers for electrical safety
- Tool storage - comes in a sturdy tool case



136-3417 36 Piece Electricians Tool Kit with Case

Kit contains:

- 01 Claw Hammer - 16 oz.
- 02 Mini Hacksaw
- 03 Compact Tape Measure - 3x16 mm / 10 ft
- 04 Torpedo Level
- 05 Ratchet Bit Driver Set
- 06 Rethreading Tool - M3.5
- 07 Single-Pole Voltage Tester (Short)
- 08 Non-Contact
- 09 Insulated Pozidriv Screwdriver (VDE) - PZ1x80 / PZ2x100 / Flat-Pozi 2x100mm
- 10 Insulated C-PLUS Phillips Screwdriver (VDE) - PH1x80/PH2x100 mm
- 11 Insulated C-PLUS Slotted Screwdriver (VDE) - 3.0x100/4.0x100/ 5.5x125/6.5x150 mm
- 12 Automatic Wire Stripper
- 13 Cable Stripper
- 14 Electrician Knife (1000V)
- 15 Insulated Combination Pliers (VDE) - 180 mm
- 16 Insulated Diagonal Cutter (VDE) - 160 mm
- 17 Insulated Long Nose Pliers (VDE) - 200 mm
- 18 RZR Series Insulated Cable Shears (VDE) - 170 mm
- 19 Insulated Water Pump Pliers (VDE) - 250 mm

125-3049 20 Tool Case, 530 x 180 x 400mm

Electrician's Tool Kit

- Ergonomic multi-component handles
- Optimum balance of torque and control
- Ideal for fine and delicate work
- High-quality multi-tools and accessories
- Range of labels



136-3402 29 Piece Electricians Tool Kit with Case

Kit contains:

- | | |
|--|---|
| <ul style="list-style-type: none"> 01 Electrician Knife (1000V) 02 RZR Series Insulated Cable Shears (VDE) - 170 mm 03 Insulated Wire Stripping Pliers (VDE) - 160 mm 04 Insulated Diagonal Cutter (VDE) - 160 mm 05 Insulated Combination Pliers (VDE) - 180 mm 06 Insulated Long Nose Pliers (VDE) - 200 mm 07 Insulated Open End Wrench (1000V) - 5.5/6/7/8/10/12/13/17/19 mm 08 Safety Goggles 09 Black/Yellow insulation tape 10 "Unsafe" Label 11 Junior Hacksaw (1000V) 12 Insulated Water Pump Pliers (VDE) - 250 mm | <ul style="list-style-type: none"> 13 Insulated Pozidriv Screwdriver (VDE) - PZ0x60/PZ1x80/PZ2x100/PZ3x150mm 14 Insulated Slotted Screwdrivers (VDE) - 2.5x75/4.0x100/5.5x125/6.5x150 /8.0x175mm 15 "Danger" Label 16 "H.V. Test Area" Label 17 "Electric Shock" Label 18 "Live Wires" Label 19 "High Voltage" Label 20 "Disconnect" Label 21 "415 V a.c." Label 22 "240 V a.c." Label 23 "115 V a.c." Label |
|--|---|

125-3049 Tool Case, 530 x 180 x 400mm

Electricians Tool Kit

- An extensive VDE approved tool kit designed for professionals who work on or around electrically live circuits.
- Ergonomic multi-component handles
- Constructed from Chrome Vanadium Steel
- Versatile and durable carry case complete with cut-out slots for each individual component.



734-8885 88 Piece Electricians Tool Kit with Case

Kit contains:

- | | |
|--|---|
| <ul style="list-style-type: none"> 1/2 Inch Sockets (14 - 32mm) 1/2 Inch Extension (125 & 250mm) 1/2 Inch Plug Wrench (16 & 21mm) 1/4in Sockets (4 - 13mm) 1/4in Extension (55 & 100mm) 1/4in Connector 1/2 Inch & 1/4in Reversible Ratchet 1/2 Inch & 1/4in Universal Joint 1/2 Inch & 1/4in Sliding T bar Metric Wrench (8 - 17mm) | <ul style="list-style-type: none"> 6in Insulated Slip joint pliers 6in Insulated Nipper pliers 6in insulated Wire strippers, 7in Insulated Wire cutters Insulated Water pump pliers Electricians Shears 250V Test pencil 300g Hammer 5m Tape measure Driver bits (x20) Insulated Screwdrivers (x5) Hex Keys (x9) |
|--|---|

VDE Approved Tools

The best electrician's tools are fully insulated against electrical shocks: an obvious safety hazard. Look for those with accreditation from the Verband der Elektrotechnik, Elektronik und Informationstechnik (VDE) – the German Association of Electrical Engineering, Electronics and Information Technology, which provides an internationally recognised standard for electrical safety.

VDE approval ensures that tools like screwdrivers are safe to use when working with electricity. A VDE approved tool means that it has passed a series of rigorous tests ensuring the quality, safety and construction.



Insulated Screwdriver and Pliers Set

- A 5 piece electricians' hand tool kit which includes the most essential tools to perform a variety of repair and maintenance tasks within an electrical environment
- Made from Chrome Vanadium Steel for increased durability and strength, allowing for longer-lasting tool life
- DuoTech soft-grip plier handles for optimum comfort and grip, even when working for long periods of time
- Each screwdriver has been designed with the ergonomic C-PLUS soft-grip handles, allowing for even transfer of force and increased comfort when applying large amounts of force for stubborn fasteners



**VDE
APPROVED**

125-3096 5 Piece Set - 1 x Insulated Combination Pliers (G10 Series), 1 x Insulated Diagonal Cutter (G12 Series), 2 x C-PLUS Insulated Slotted Screwdrivers (G01 Series), 1 x C-PLUS Insulated Pozidriv Screwdrivers (G03 Series)

Insulated Electrician's Knife

- 1000V approved cable knife, ideal for use on or around energised systems
- Sickle shaped strong and durable stainless-steel blade for long lasting blade life and can easily and efficiently cut the cable sheath without the risk of damaging the cable
- Blade guard on handle to avoid slippage injuries
- Lanyard hole for working at height



829-6518 44mm Blade

**VDE
APPROVED**

Insulated Plier Set with Foam Module

- 3 Piece VDE Plier Quality Set is for working on 1000V AC or 1500V DC
- DuoTech Soft grip handles allow for easy and smooth action
- Smooth Operating Action reduces the fatigue of the user
- Supplied with Foam Module ensures the tools are kept tidy

**VDE
APPROVED**



833-5931 3 Piece Set, 180mm Combination Pliers (G10), 160mm Diagonal Cutters (G12), 160mm Long Nose Pliers (G15)

Plier Sets

- Special tool steel Polished finish (electofilmed)
- DuoTech soft grip handles
- G10 - ISO 5745
- G12 - ISO 5749

VDE APPROVED



125-3094 2 Piece Set - Insulated Combination Pliers (G10 Series) & Insulated Diagonal Cutter (G12 Series)

Plier Sets

- Special tool steel
- Chrome finish
- DuoTech soft grip handles

VDE APPROVED



125-3095 3 Piece Set - Diagonal cutter, long nose plier & combination plier

Insulated Water Pump Pliers

- Ideal for live working up to 1000Vac or 1500Vdc
- 9 position adjustment
- Chrome Vanadium steel
- Phosphate finish
- Soft-grip handles

VDE APPROVED



125-3076 Multigrip Slip Joint, 250mm

Insulated Combination Pliers

- Special tool steel and chrome finish
- DuoTech soft grip handles
- VDE Approved, ISO 5745

VDE APPROVED



125-3065 G10 Series, Combination, 160mm

125-3066 G10 Series, Combination, 180mm

125-3067 G10 Series, Combination, 200mm

Insulated Long Nose Pliers

- Chrome finish
- DuoTech soft grip handles
- ISO 5745
- G15 Series

VDE APPROVED



125-3072 G15 Series, Long nose, 160mm

125-3073 G15 Series, Long nose, 200mm

Diagonal Cutters

- Special tool steel; Chrome finish
- DuoTech soft grip handles
- ISO 5749, G12 Series

VDE APPROVED



125-3070 G12 Series, 180 mm

125-3068 G12 Series, 140 mm

125-3069 G12 Series, 160 mm

Angled Long Nose Insulated Pliers

- Special tool steel
- Chrome finish
- DuoTech soft grip handles
- VDE Approved, ISO 5745

VDE APPROVED



125-3074 G16 Series, Bent nose, 200mm

Insulated Pliers

- 45° angled blades
- Ergonomic handles
- Ideal for precision work with soft wire

VDE APPROVED



847-3800 Long nose

Insulated Non-Impact Sockets

- Bi-Hex (12 point) Socket Heads
- Each tool is injection moulded
- Nylon 11 insulation
- 1/2 Inch Square drive
- 8mm to 32mm sizes available
- IEC60900, Category 'C', 1000v

**IEC
60900:2004**



- 911-1402 8mm
- 911-1409 10mm
- 911-1411 12mm
- 911-1415 13mm
- 911-1424 14mm
- 911-1421 16mm
- 911-1430 17mm
- 911-1433 18mm
- 911-1437 19mm
- 911-1446 20mm
- 911-1443 22mm
- 911-1455 24mm
- 911-1459 25mm
- 911-1461 27mm

Insulated Ratcheting Ring Spanners

- The 72-tooth ratchet ring and gear produce a 5° rotation allowing it to function in tight spaces.
- Each tool is injection moulded
- Nylon 11 insulation
- IEC 60900:2004 specification

**IEC
60900:2004**



- 911-1308 10mm
- 911-1310 13mm
- 911-1326 17mm

Insulated Reversible Ratchet Spanners

- Each tool is injection moulded
- Reversible for added flexibility
- Nylon 11 insulation
- IEC 60900:2004 specification

**IEC
60900:2004**



- 911-1487 13x17mm
- 911-1496 17x19mm

Insulated Ring Spanners

- Single Ended with 60° Offset Head
- Each tool is injection moulded with Nylon 11 insulation
- IEC 60900:2004 specification
- Heavy-duty spanners for use in any application

**IEC
60900:2004**



- 911-1288 10mm
- 911-1281 13mm
- 911-1285 17mm
- 911-1294 19mm

Insulated Open Ended Spanners

- Each tool is injection moulded
- Nylon 11 insulation
- IEC 60900:2004 specification
- Warning thumb stop

**IEC
60900:2004**



- 911-1187 10mm
- 911-1193 13mm
- 911-1203 17mm

Insulated Torque Wrenches

- Each tool is injection moulded with Nylon 11 insulation
- IEC 60900:2004 specification
- Easy to read Window scale
- Reversible action

**IEC
60900:2004**



- 911-1531 1/2"
- 911-1522 3/8"

Hexagon Nut Driver Set

- Made from chrome vanadium molybdenum steel blade material
- Hexagon tip type
- VDE/1000 V approved

**VDE
APPROVED**



- 182-9772 Set of 5 - Tip size of 6 mm, 7 mm, 8 mm, 10 mm, 13 mm

Insulated Nut Spinners

- 150mm stud clearance
- Each tool is injection moulded
- Nylon 11 insulation
- IEC 60900:2004 specification
- Available in various metric and BA sizes

**IEC
60900:2004**



- 911-1503 0BA
- 911-1506 1BA
- 911-1500 2BA
- 911-1519 3BA
- 911-1512 4BA
- 911-1525 8mm
- 911-1528 10mm

Insulated Screwdrivers

- For live working up to 1000 V ac or 1500 V dc
- Chrome Vanadium Molybdenum steel blade (phosphate finish)
- C-PLUS soft-grip handle
- Individually tested as per DIN EN 60900: 2004 norm



| | |
|----------|-----------|
| 125-3078 | 2.5x75mm |
| 125-3079 | 3x100mm |
| 125-3080 | 3.5x100mm |
| 125-3081 | 4x100mm |
| 125-3082 | 5.5x125mm |
| 125-3083 | 6.5x150mm |
| 125-3084 | Ph1x80mm |
| 125-3085 | Ph2x100mm |
| 125-3086 | Pz1x80mm |
| 125-3087 | Pz2x100mm |
| 125-3088 | MOD1x80mm |
| 125-3089 | MOD2x80mm |

Screwdriver Set with Voltage Tester

- Slotted and Pozidrive screwdrivers
- VDE approved tools for working in rigorous health and safety standards
- Voltage tester included
- Ergonomic soft grip handles



875-5812 4 x Slotted Screwdrivers (3 mm, 4 mm, 5.5 mm, 6.5 mm), 2 x Philips Screwdriver (PH1, PH2), 1 x Voltage Tester

Insulated Screwdriver Set

- 10-Piece 1000V insulated screwdriver set manufactured with durable chrome-molybdenum vanadium steel and easy grip handles



253-015 Slotted (2.5; 3; 4; 5.5; 6.5mm), Phillips (PH0; PH1 PH2), Pozidriv (PZ0; PZ1)

4 Piece Slotted Insulated Screwdriver Set

- 1000Vac and 1500Vdc voltage isolation
- DuoTech ergonomic handle
- Tested according to DIN EN 60900: 2004
- For full set contents visit our website



125-3092 3 x slotted, 1 x Philips

125-3093 3 x slotted, 1 x Pozi

Screwdriver Set with Voltage Tester

- Slotted and Pozidrive screwdrivers
- VDE approved tools for working in rigorous health and safety standards
- Voltage tester included
- Ergonomic soft grip handles



875-5821 4 x Slotted Screwdrivers (3 mm, 4 mm, 5.5 mm, 6.5 mm), 2 x Pozi Screwdrivers (PZ1, PZ2), 1 x Voltage Tester

300mm Circlip Plier Set

- 4 Piece Circlip Plier Quality Set for inserting and removing circlips
- Ergonomic Red PVC grip handles allow for easy and smooth action
- External Pliers have a sprung design to help handles open
- Supplied with a Foam Tool Module to ensure the tools are kept tidy
- Made from Chrome Vanadium Steel



833-5929 External Circlip Pliers (Straight with Spring), External Circlip Pliers (Bent with Spring), Internal Circlip Pliers (Straight), Internal Circlip Pliers (Bent)

Din Standard Circlip Pliers

- Fitted with red PVC vinyl dipped covered handles
- External types incorporate return springs
- Black oxidised finish



541-6781 Internal bent 3-10mm

541-6826 External straight 3-10mm

541-6753 Internal straight 3-10mm

541-6769 Internal straight 8-25mm

Interchangeable Multi-Position Circlip Pliers

- Cushion-grip handles and spring loaded for faster comfortable operation



541-7267 External 6.4-25.4mm

182-436 External/internal 6.4-48mm/6.4-25.4mm

Locking Pliers Set

- Locking pliers maintain constant gripping force
- The guarded release lever is an important safety feature
- Supplied in a plastic tool roll pouch
- Ease of storage and transportation



847-3762 Chrome Molybdeum Steel, 180mm, 3 Pieces - 10" & 7" Locking Pliers with built-in wire cutter, 6" Long Nosed Pliers

847-3768 Chrome Vanadium Steel, 250mm, 3 Pieces - 10" & 7" Locking Pliers with built-in wire cutter, 6" Long Nosed Pliers

3 Piece Plier Set, 250 Mm Overall

- 3 Piece Plier Quality Set with Polished Finish
- Ergonomic Soft grip handles allow for easy and smooth action
- Smooth Operating Action reduces the fatigue of the user
- Serrated Jaws for an excellent prolonged grip
- Supplied with Foam Module ensuring the tools are kept tidy



833-5972 3 Pieces - 180 mm Combination Pliers, 160 mm Diagonal Side Cutters & 160 mm Long Nose Pliers

Electronic Pliers

- Strong and Hardwearing body
- Specially designed ergonomic handles



847-3780 Slim Side cutters, 4.5 inch, Cutting capacity soft wire: <0.8mm

847-3784 Side cutters, 4.5 inch, Cutting capacity soft wire: <1.3mm

847-3816 End nipper

Combination Pliers

- Optimum cutting edge geometry
- Precision milled
- Heat treatment to exacting standards
- Redesigned DuoTech grips



875-5767 140mm

487-230 150mm

875-5761 160mm

875-5770 180mm

875-5773 200mm

875-5802 200mm

Diagonal Cutters

- Duo Tech soft grip handles
- Polished finish (Electrofilmed)
- DIN/ISO 5749, TS 11071



875-5792 140mm

875-5795 160mm

875-5799 180mm

875-5806 Power 180mm

Engineers Pliers

- Induction hardened with a natural finish to ensure a long, reliable working life
- Ergonomically designed bow handles with PVC grip provide maximum leverage and comfort



541-7093 Radio 140mm

541-7071 Snipe nose 120mm

541-7043 Snipe nose 160mm

Electronic Pliers

- Strong and Hardwearing body
- Specially designed ergonomic handles



847-3756 Radio 140mm

847-3724 Radio 200mm

847-3752 Round nose 130mm

847-3737 Snipe nose 120mm

847-3737 Snipe nose 130mm

Impact Socket Sets

- Impact-rated 6-point chrome molybdenum sockets
- Storage case with labelled moulds for each size
- Exceed ANSI specifications, with two grease rings for grip
- Centre hole punched for extra depth, Z-Drive for strong grip
- Thin wall design with chamfered openings



137-0909 18 Piece Impact Socket Set, 1/2" Metric, 10 > 32mm

137-0908 8 Piece Air Impact Socket Set, 1/2" Metric, 12 > 24mm

66 Pieces 1/4 Inch And 1/2 Inch Socket Set

- Chrome Vanadium for excellent strength and corrosion resistance
- Soft comfortable ratchet handles for reduced fatigue and a tighter grip
- Fitted case reduces lost parts
- Bit sizes marked directly on the holders for quick identification of missing bits
- Strong latches for secure closing
- 75 mm and 250 mm extension bar for hard to reach areas



817-9249 66 Piece Metric 1/2 in; 1/4" Standard Socket/Bit Set with Ratchet

Socket Bit Set

- 45 Piece hexagon, spline & TX bits with adaptors in a handy storage case



213-1011 45 Piece Metric 1/2 in; 3/8" Standard Socket/Bit Set

46 Pieces 1/4 inch and 3/8 inch Socket and Bit Set

- Chrome Vanadium for excellent strength and corrosion resistance
- Soft comfortable ratchet handles for reduced fatigue and a tighter grip
- Fitted case reduces lost parts
- Bit sizes marked directly on the holders for quick identification of missing bits
- 1/4 and 3/8 Inch drive options



817-9242 46 Piece Metric 1/4 in; 3/8" Standard Socket/Bit Set with Ratchet

61 Piece Socket Set, 1/2 In, 1/4 Inch, 3/8 Inch Square Drive

- Drive size of 1/2 in, 1/4 Inch and 3/8 in
- Square drive type
- Chrome finish
- Chrome vanadium steel material
- 61 Pieces



480-6880 Socket Sizes (4 > 14, 9 > 19, 9 > 24mm), Drive Sizes (1/2 in, 1/4", 3/8 in)

Universal Switch Key Wrench

- Compact, yet durable tool designed for use with a wide range of applications including locking systems and valves



- 439-3019** Chrome finish
- 439-3025** Zinc alloy finish

Penknife Hexagonal Sets

- Metric and imperial sets of hexagon keys which fold into a convenient penknife style handle
- Keys have blackened finish, steel handle is bright zinc-plated



- 451-8993** 7 Piece metric, 1.5mm, 2.0mm, 2.5 mm, 3 mm, 4 mm, 5 mm, 6 mm
- 314-2977** 7 Piece metric, 2.5 mm, 3 mm, 4 mm, 5 mm, 6 mm, 8 mm, 10mm
- 537-754** 9 Piece imperial long arm, 5/64 > 1/4in
- 451-9003** 9 Piece imperial short arm, 0.05 > 3/32in
- 537-760** 9 Piece metric, 1.5 > 8mm

Plastic Holder Sets

- Short arm L-shaped hexagon key sets in tempered chrome-vanadium steel, with chemically blackened finish
- Contains 10-pieces 1.5-10mm, supplied in plastic holder



- 537-748** 10 Piece L Shape Metric Hex Key Set, 1.5 > 10mm

52 Piece Metric 1/4 Inch Deep Socket/Standard Socket/Allen Key/Bit Set With Ratchet

- High-quality square 6-point metric socket set and hex keys
- Steel construction for strength and durability
- Bright red foam for quick part identification
- Comfortable reversible quick-release ratchet handle
- Long arm L-shaped key set in plastic caddy for easy storage
- Foam tool modules designed for easy removal from drawers



- 833-5935** 52 Piece 1/4" Drive Socket and Hex Key Set

Bit/Socket Set

- Hardened Chrome Molybdenum Steel bits
- Chrome Vanadium Steel nuts with zinc alloy
- Chrome-plated bit holder, sandblasted finish
- Innovative case for easy access and transport
- Kit includes various drivers, sockets, and screwdriver heads



- 213-1005** 30 Piece Set - Bit Holder (1), Bits (20), Screw Finders (2), Sockets (7)

High-Speed Steel (HSS) Step Drill Bits

- High quality
- Reduced vibration
- Faster drilling rate



HSS Step Drills, De-burring

- Multi-Dia. cutters requiring no pilot hole to cut stainless steel, carbon steel, soft metals and plastic
- 3-flute cutting action provides accurate parallel holes in sheet material up to 3mm thick
- 3mm increments



123-8510 9 Steps, 4 to 12 mm, 6.5 mm shank

123-8513 10 Steps, 4 to 22 mm step drill 10 mm shank

123-8508 10 Steps, 6 to 30.5 mm, 10 mm shank

123-8509 12 Steps, 6 to 30 mm, 10 mm shank

123-8515 12 to 25 mm Clearance & Tapping step drill

123-8511 13 Steps, 5 to 35 mm, 13 mm shank

123-8514 16 to 25 mm conduit entry step drill

123-8512 16 to 32 mm conduit entry step drill

232-529 8 to 41 mm Drill Bit, 11 Steps, 5 mm Max Drilling Thickness

232-507 6 to 36 mm Drill Bit, 11 Steps, 5 mm Max Drilling Thickness

232-513 7 to 37 mm Drill Bit, 11 Steps, 5 mm Max Drilling Thickness

Bi-metal hole saws

- Hardened cutting edge welded to a tough alloy steel body
- For use with ferrous and non ferrous metals, plastics and wood to a depth of 32mm
- 14-30mm dia saws require a 6.5mm arbour
- 32-152mm dia saws require a 9.5mm arbour



215-978 9.5mm Arbour

215-990 Pilot drill bit, 6.5 mm

Thinwall Hole Saw Kits

- Choice of Thinwall and TCT hole cutter kits
- Use on multiple materials - wood, thin sheet metal and plastic



918-6409 7-piece TCT

Carbide Hole Saw Set

- Tungsten Carbide tipped hole saws give you outstanding cutting performance and product durability
- For use on multiple materials including stainless steel, mild steel, copper and brass sheets



673-4718 20mm

673-4712 22mm

673-4724 32mm

Metric HSS Twist Drill Bits

- Perfect for general purpose workshop and maintenance drilling work
- High Speed Steel (HSS) construction, ideal for use with power tools
- Black finish for corrosion and wear protection



213-089 2.5mm

HSS Cobalt Jobber Drills

- Plan Shank
- Various lengths
- Cobalt (5%)
- HSS for performance and safety
- Perfect for general workshop and maintenance use



216-656 2.5mm

216-482 3.3mm

216-583 5.0mm

170-Piece HSS-TiN Coated Jobber Drill Set

- Large High Speed Steel Titanium coated drill set
- Contains multiples of some of the most popular sizes 1.0mm to 10mm drill bits in 0.5mm increments
- Ground flute
- Ideal for general workshop applications
- Manufactured to DIN338 standard
- Heavy duty steel case with moulded rigid insert for secure storage of drill bits



507-1732 170 PCS

Cobalt Jobber Drill Sets

- HSCo (5%) jobber drills for use on alloy steel, hardened steel, stainless steel, cast iron and titanium
- 135° split point



216-678 19-piece 1-10mm

216-690 25-piece 1-13mm

Jobber Drill Sets

- Ground flute High Speed Steel jobber drills
- Ideal for general workshop or maintenance use where high precision and productivity are not required
- Housed in a steel case



507-1704 19-Pieces 1-10mm

212-941 25-Piece 1-13mm

HSS TiN Coated Drill Bits

- Titanium Nitride Coated (TiN)
- Longer shaft length
- Right angle cutting tip
- 118° cutting angle
- Available in sizes from 0.25 – 20mm
- Suitable for metals, woods, plastics



213-411 3.0mm

213-304 3.5mm

213-922 2.5mm

213-203 5.0mm

Rolled Forged

- Rolled Flute; Copper Brazed Percussion Grade Carbide Tip
- Straight Shank



215-057 6mm Dia. x 400mm

215-192 10mm Dia. x 150mm LG

Micro HSS Drill Bit Set

- Versatile set with micro drill bits in a variety of sizes
- Perfect for use with a range of materials including plastic, wood, aluminium, glass fibre and more
- Ideal for producing clean and precise holes
- Supplied in a plastic storage case with sizes printed on to keep them organised



457-627 0.5 mm to 2.2 mm

HSS Jobber Drill Bit

- DIN338
- Fully Ground Drill
- 188o Point Angle



787-7330 0.40mm, 5 Pieces

787-7337 0.50mm, 5 Pieces

787-7349 0.60mm, 5 Pieces

787-7359 0.80mm, 5 Pieces

Compact Multimeters

- Manual ranging, 2000 count DMM that measures capacitance, voltage, current, resistance and temperature



1231939 RS12 Manual Ranging

Compact Multimeters

- 2000 Counts LCD backlit display
- Voltage 600V ac/dc
- Current 10Aac/dc
- Resistance
- Temperature measurement (RS14)
- Continuity
- EN61010-1 CAT III 600 V



1231938 RS14 Autoranging

Handheld Digital Multimeter

- Digital multimeter
- Compact and handheld
- Measures AC/DC Voltage, AC/DC current, Resistance, Diode test, Continuity, Capacitance Frequency and Temperature
- Non-Contact AC Voltage detector
- Long service life
- Battery type: 2 x AAA 1.5V



2647228 RS-927A, True RMS, 10A ac Max, 10A dc Max, 600V ac Max

Insulation & Continuity Testers

- Triple insulation voltage Test Ranges: 250V; 500V; 1000V (RS5505 adds 125V range)
- 200mA short current continuity range
- Test Hold function for easy operation
- Over range indication
- 1 mA test current for MΩ range at rated voltage
- Meets IEC 10101, CAT III 1000 V



123-1931 2GΩ CAT III 1000 V

Clamp Meter

- 400A AC auto-ranging clamp meter with AC and DC voltage, resistance, continuity functions
- Uses non-contact detection with Overvoltage Category III 600 V protection
- Supplied with test leads, carrying case, temperature probe, AAA 1.5 V batteries x2 and user manual



1231935 RS380, 400A ac CAT III 600 V

True RMS AC/DC Clamp Meter with Dual Type K Inputs

- Large, easy-to-read backlit LCD display for greater functionality, the clamp meter is also ideal for use in low light environments
- Comes with a 9 V battery, test leads and a temperature probe



2003702

Compact Digital Multimeter

- Compact design makes this multimeter ideal for working on the go
- Clear and precise 2000 count LCD display screen
- Safety category CAT III, CAT IV, 600 V, 1000 V
- Ideal for measurement of AC Current, AC Voltage, Continuity, DC Current, DC Voltage, Diode, Resistance
- Test leads included



1611625

3 in 1 Wall Scanner

- Detects metal or wooden studs from 0-38mm through drywall
- Live AC wires can be detected from 0-50mm through drywall
- Handheld and powered by a 9V battery
- Supplied with a 9V battery and gift box



193-8684 Stud, Metal and AC Voltage Finder

Earth & Ground Resistance Tester

- Meets IEC10101, CATIII 1000V
- Large dual display with back light & Low Battery Indication
- Test hold function for easy operation
- Zero Automatic adjustment
- Sampling Rate: 2.5 times per second
- Includes x 6 "AA" batteries, test leads and carrying case



144-5339 ET5300, 2kΩ

Infrared Thermometers

- IR non-contact mode
- Pocket sized pistol grip
- Built-in laser sighting
- Backlit LCD display
- 123-2217 also accepts a plug-in type-K thermocouple probe (-150°C to +1350°C)



123-2216 -20°C to +500°C

123-2217 -150°C to +1350°C

Magnetic Field Indicator / Solenoid Testers

- Powerful red light in the tip to indicate the presence of a magnetic field.
- Easy to use.
- Solenoid valves in pneumatic and hydraulic control equipment can easily be tested.



375-5422 0.3mT, 1000V ac

141-1996 ATEX, 0.3mT

Resistance Decade Box

- Decade box for electrical resistance measurement
- Heavy-duty construction for durability in harsh environments
- 7-decade ranges from 1 to 111Ω in 1Ω increments
- Separate grounding terminal, isolated substitutions
- Powered by 0.3W resistors, versatile for various applications



193-8686 R-100

Voltage Tester

- LED display indicator for visual notification
- Audible buzzer for enhanced notification
- Wide operating temperature range
- IP67 rating for protection from dust and liquid

IP67 RATED



161-1627 LED Display, Buzzer Indicator & Torch

Probe Sets

- 0.7mm (0.028") O.D. Back Probe Pins
- Ideal for fuel injectors, sensors, weather pack connectors
- Compatible with industry-standard 4mm plugs
- Perfect complement to test leads
- Cable piercer option minimizes cable damage



124-7405 Ultra Thin Back Probes, Black/Red

124-7402 Ultra Thin Back Probes with Cable Piercer, Black/Red

Multimeter Test Lead

- Crocodile clip jaws will open to 5.5 mm at the tips
- Pack of 10: 2 x red, 2 x black, 2 x Green, 2 x yellow and 2 x white



161-6511 0.5m, Pack of 10

Tape Measure

- Self-locking mechanism allows blade to be extended smoothly
- Push button allows blade to be retracted smoothly
- Nylon coated blade for maximum durability
- Impact resistant rubberized case



254-6240 3m
 851-3541 5m
 254-6242 8m

Self Adhesive Measuring Tape

- 1.2m steel measuring tape
- White power coated finish
- Self-adhesive backed



706-8141 1.2m
 706-8145 1.2m / 4ft

Magnetic Steel Rule

- Suitable for fixing to machine guides, fixed guillotine blades and sheet metal during marking out
- Rule contains encapsulated button magnets
- Rigid satin chrome steel rule conforms to BS4372
- Etched graduations and markings are black paint filled to provide excellent clarity



387-0098 600mm

Laser Distance Measure

- Designed for quick, non-contact measurement of areas and volumes of rooms, heights, distances and angles
- Light & pocket-sized digital measure for easy transport
- Records up to 20 points, with laser pointer targets
- LCD status indicator and distance calculator functionality

**IP54
RATED**



254-6241 0.05 □ 50m Range, ±1.5 mm Accuracy

Multifunctional Laser Level

- Single button control & professional accuracy
- Green beam laser projects from multiple angles
- Rotatable 360-degree with magnetic 'L' mount
- Soft-grip, light weight design & easy carrying – supplied with a nylon bag



230-7854 Self-levelling laser

High Impact Spirit Level

- Sturdy design with strong non-magnetic base
- Electrostatic powder coating
- Frame constructed from aluminium
- 2 Vials – horizontal and vertical
- Accuracy ±0.5 mm/m



851-3541 250mm

Box Spirit Levels

- Aluminium box section spirit levels with two solid block vials that will never leak, fade, fog or break
- Strong and robust, designed for professionals to give accurate results
- Available in a choice of lengths



851-3557 16"
 851-3551 24"

Pocket Level

- 0.5 mm/m (0.029°) accuracy
- Ultrasonic welded block vials
- Rigid aluminium box section
- Shockproof end caps
- Built-in magnets

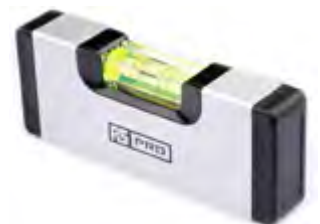

194-4705 120mm

Measuring And Cutting Tool Kit with Foam Inlay

- General-purpose compact workshop measuring and cutting toolset
- Contains precision measuring tools and heavy-duty cutting tools
- The bright red foam helps identify missing parts quickly
- Foam tool modules are designed for regular easy removal from drawers



833-5944 6 Pcs - Electricians scissors, Straight snip, Snap-off utility knife, Measuring tape, Stainless steel ruler, Leaf metric feeler gauge

Digital Vernier Caliper

- A digital vernier caliper with stainless steel rule & jaws, and offering 4 way measurement
- Measurement range of 0mm and 150mm or 0mm and 200mm with a resolution of 0.0005in, 0.01mm



243-6616 150 mm/6", Metric

243-6615 150 mm/6", Imperial/Metric

243-6617 200 mm/8", Imperial/Metric

Fine Adjustment Vernier Caliper

- Vernier Caliper with hardened Stainless Steel frame and jaws for extremely accurate outside, inside, step and depth measurements.
- Dual scale with both metric and imperial readings
- Manufactured from hardened steel
- Fine adjustment mechanism with lockscrews



841-2533 300mm/ 12in, Imperial/Metric

Folding Lock Back Trimming Knife

- Heavy duty retractable
- Blade lock promotes not only safety but also helps with keeping the blade in a good condition, the blade auto-lock contributes to easy storage of the knife too
- The main body is comprised of aluminium
- Ergonomically designed handle helps with the handling of the knife, this also helps add pressure to the nose of the blade knife when being used to cut materials such as plasterboards, wire and carpets
- Accepts industry standard blades



789-4596 80 mm x 30 mm

Standard Utility Knife Blades

- Heavy duty knife blades for trimming knife
- Available in packs of 5 and 10



613-460 5 x concave

546-758 5 x heavy duty

613-454 5 x hooked

541-6646 10 x trapezoid

7 Drawer Cabinet

- Sturdy, premium sheet steel construction
- Electrostatic powder coating, scratch-resistant
- 7 fully extendible drawers with tool module compatibility
- Smart-Lock™ system prevents accidental opening
- Smooth telescopic ball bearing slides
- Central locking, holders for spray cans and paper rolls
- Recessed worktop with quality mat



833-5900 7 Drawers, 975 × 710 × 450, 66.4 kg

833-5903 7 Drawers, Jumbo Size, 975 × 890 × 450, 72.5 kg

Tool Chests

- Electrostatic matt powder coated, scratch proof.
- 80 mm deep top locker.
- Integrated carrying handles.



768-1671 6 Drawers, 350mm x 530mm x 340mm, 18kg

768-1678 3 Drawers, 365mm x 620mm x 440mm, 20kg

Drill Bit Case with Organiser

- 11 trays to help keep things organised
- Lightweight
- Transparent lid to make selections easier
- Anti-migration bars to ensure small parts stay in place
- Strong clasps



838-6529 11 trays

Drawer Unit

- Stackable, wall mountable small parts storage
- Dividable drawers with drawer stops
- Supplied with dividers and ID labels



178-3331 15 Drawer Cabinet

178-3368 36 Drawer Cabinet

Plastic Compartment Box with Adjustable Dividers

- Secure double lock
- Tough transparent lid with anti-migration bars to ensure small parts stay in place
- Integrated ergonomic handle
- 17 compartments - with movable dividers



435-0179 395 x 305 x 60mm

Slide-locking Box

- Strong hinges, sliding locks
- Ideal for the storage of nuts, washers, screws and small component parts



784-6058 12 Compartments

Instrument Bags

- Padded bags designed for the safe transportation of sensitive electronic equipment, tools and components
- Constructed from tough, waterproof Polyester with removable base board



| | |
|-----------------|---------------|
| 707-7338 | 300x150x250mm |
| 707-7331 | 360x150x280mm |
| 707-7335 | 445x170x330mm |

Tool Belts

- Constructed from tough padded tear resistant polyester
- Double fastening adjustable belt (90 – 120 cm)
- Modular tool belt comprising of 3 separate sections
- Drill holster with secure strap



788-7220 Electricians tool pouch

Tool Case

- Waterproof (IP67)
- Dustproof
- Impact/shock resistant
- Stackable
- Soft-grip carry handle
- Lockable with padlock (not included)

**IP67
RATED**



125-3049 530 x 180 x 400mm, 5kg

Plastic Tool Box

- Removable tote tray for quick access to small parts
- Two built-in organisers with lids for the sorting and storage of fasteners and fixings
- Telescoping design carry handle for easy transportation and a compact design



833-5988 19"

Rucksacks and Toolbags

- 16" rucksack with reflective piping
- Comfortable padded shoulder straps
- Double zipped bottom section
- Mobile phone/mp3 player holder on strap



788-7211 16"

Tool Bag With Shoulder Strap

- Constructed with tear-resistant padded polyester, with a durable welded waterproof plastic base. This ensures that your cargo is adequately protected against the elements and casual impacts.



788-7205 310mm x 200mm x 210mm

Tool Balancers

- Suitable for a wide range of drivers
- Cord with cable stop
- Durable plastic composite housing designed to hang overhead



| | |
|-----------------|-----------|
| 793-2774 | 0.5-1.2kg |
| 793-2777 | 1.0-2.0kg |
| 793-2771 | 2.0-3.0kg |

Duct Tape

- Adhesion strength of 3.5 Newton centimetres (N/cm) to 5.5 N/cm
- Adhesive material made from rubber resin
- Fabric backing material
- Elongation at break of 0.24
- Gloss finish
- Thickness of 0.23 mm
- Maximum operating temperature of +80°C
- Minimum operating temperature of -50°C
- Tensile strength of 32 Newton centimetres (N/cm)



| | |
|-----------------|----------------------------------|
| 146-7415 | Yellow, 50mm x 50m, Gloss Finish |
| 146-7416 | Silver, 50mm x 50m, Gloss Finish |
| 146-7418 | Red, 50mm x 50m, Gloss Finish |
| 146-7419 | Blue, 50mm x 50m, Gloss Finish |
| 146-7414 | Black, 50mm x 50m, Gloss Finish |

PTFE Extra Thick PTFE Tape

- Extra thick PTFE tape designed for sealing threads in just one wrap
- Only requires 50% overlap on the thread for BS21 thread up to 2 inches.
- Suitable for more aggressive environments where acids, gases or solvents may be present
- Easy to apply and handle
- Robust pressure resistant



| | |
|-----------------|--------------------------------|
| 231-964 | White, 12mm x 5m, 0.2mm Thick |
| 183-3490 | White, 12 mm x 12 m x 0.075 mm |

Double Sided Paper Tape

- Easy to tear and flexible, allowing for minimal application and installation time, especially when working with irregular or round surfaces
- Paper coated tape with an aggressive specially constructed adhesive, which is then interleaved with a release liner for fuss-free use
- RoHS compliant



| | |
|-----------------|--------------------------------|
| 223-1093 | White, 50mm x 50m, 0.1mm Thick |
| 223-1087 | White, 25mm x 50m, 0.1mm Thick |
| 223-1080 | White, 19mm x 50m, 0.1mm Thick |
| 125-4306 | White, 9 mm x 50 m |
| 125-4304 | White, 25 mm x 50 m |
| 125-4303 | White, 15 mm x 50 m |
| 125-4302 | White, 12 mm x 50 m |
| 223-1094 | Yellow, 50 mm x 50m |

Self Amalgamating Tapes

- Easy unwind & extremely flexible
- Resistant to water, ozone and UV
- Excellent low and high temperature performance as well as excellent conformability to awkward shapes
- Breaking load is 20.0N/cm and elongation is 600%



| | |
|-----------------|-------------------|
| 146-8999 | Black, 50mm x 10m |
| 146-8998 | Black, 25mm x 10m |
| 146-9000 | Black, 19mm x 10m |

Clear PP Double Sided Tape

- Flame retardant
- PP film coated tape with thin gauge polycarbonate film with polished surfaces on each side
- Easy to tear and flexible, allowing for minimal application and installation time, especially when working with irregular or round surfaces



| | |
|-----------------|--------------------|
| 223-1085 | Clear, 38 mm x 50m |
| 223-1092 | Clear, 38 mm x 50m |

PVC insulating tapes

- UV resistant
- Water resistant
- Flame retardant
- Self-extinguishing
- Easy to tear by hand
- Breakdown Voltage 8000V
- Compliant to EN 60454-3-1 Type 2



| Stock No. | Colour | Thickness | Length |
|-----------|--------|-----------|--------|
| 134-7321 | Black | 12 mm | 20 m |
| 134-7329 | Black | 38 mm | 20 m |
| 134-7319 | Black | 19 mm | 33 m |
| 134-7330 | Blue | 12 mm | 20 m |
| 134-7324 | Blue | 19 mm | 33 m |
| 134-7334 | Green | 12 mm | 20 m |
| 134-7331 | Green | 19 mm | 33 m |
| 134-7325 | Green | 12 mm | 20 m |
| 134-7328 | Green | 19 mm | 33 m |
| 134-7327 | Red | 12 mm | 20 m |
| 134-7323 | Red | 19 mm | 33 m |
| 134-7333 | White | 12 mm | 20 m |
| 134-7335 | White | 38 mm | 20 m |
| 134-7320 | White | 19 mm | 33 m |
| 134-7332 | Yellow | 12 mm | 20 m |
| 134-7326 | Yellow | 19 mm | 33 m |

Double Sided PVC Tape

- Designed for high adhesion, heavy-duty applications, offering secure and long-lasting attachment to surfaces for complete peace of mind
- PVC film coated tape with an aggressive clear acrylic adhesive, which is then interleaved with a release liner for fuss-free use
- Strong adhesive properties that make it resistant to high temperatures, U.V and difficult substrates



223-1090 Yellow, 38 mm x 50m

223-1083 Yellow, 19mm x 50m, 0.245mm Thick

223-1077 Yellow, 12 mm x 50m, 0.245mm Thick

Foam Tapes

- Low density PVC foam sealing strips
- Closed cell construction gives a positive seal at only 30% compression
- Seal cabinets, enclosures and machines against light, dust, moisture etc.



205-0912 Grey, 9mm x 30m, 3mm Thick

205-0805 Grey, 6mm x 30m, 3mm Thick

205-0940 Grey, 25mm x 15m, 6mm Thick

733-6797 Grey, 5 m x 20 mm x 6.4 mm

733-6785 Grey, 15mm x 5m, 3.2mm Thick

733-6781 Grey, 12mm x 5m, 2.4mm Thick

205-0833 Grey, 12mm x 30m, 3mm Thick

205-0928 Grey, 12mm x 30m, 3mm Thick

205-0883 Black, 25mm x 15m, 6mm Thick

205-0906 Black, 25mm x 10m, 10mm Thick

619-1786 Black, 20mm x 10m, 5mm Thick

619-1770 Black, 20mm x 10m, 3mm Thick

619-1764 Black, 15 m x 10 mm x 5 mm

619-1758 Black, 15mm x 10m, 3mm Thick

205-0861 Black, 12mm x 30m, 3mm Thick

205-0877 Black, 12mm x 15m, 6mm Thick

567-963 Black, 12mm x 10m, 3mm Thick

205-0899 Black, 12mm x 10m, 10mm Thick

619-1742 Black, 10mm x 10m, 5mm Thick

619-1720 Black, 10 m x 10 mm x 3 mm

Reflective tape

- Specially designed for application to plastic and rough substrates
- Should be applied at temperatures between 0°C and +25°C
- Recommended for use on flat surfaces



219-7897 Black/Yellow, 50mm x 25m

219-7881 Black/Yellow, 100mm x 25m

PPE & SITE SAFETY

RS PRO have personal protective equipment for any electrical application and the products you need to keep your site safe and secure.

General Purpose Nylon Polyurethane-Coated Reusable Gloves

- Ultrane 548 Polyamide (nylon) knitted gloves with palm and fingers coated with black Polyurethane foam
- Elastic knit wrist
- Popular and cost effective alternative to the Rigger Glove
- Textured external surface
- Length: 24 - 26cm
- Bag of 12 pairs supplied



475-693 9 - M
475-697 10 - L

Cut Resistant Latex-Coated Cut Resistant Gloves

- EN388 Cut level 5 protection
- Perfect for working environments where there is a cut risk
- Water resistant
- Extra grip coating



869-1610 8 - S
869-1613 9 - M
869-1617 10 - L

Leather Welding Gloves

- Premium quality chrome leather (LW93)
- Weltd Seams protect against thermal and mechanical discharge
- Thermal Lining improves comfort and contact heat protection
- Specifically designed for type A (Mig / Arc welding) and light mechanical handling
- Compliant with BS EN 12477 - Welding Standard
- Suitable for heavy duty thermal welding applications
- length: 350mm



622-7071 Red

Bump Cap

- High-profile ABS shell acts as a shock absorber and comes with a soft padded crown, giving optimum safety and protection for the wearer
- Features a short peel of 3cm which allows for increased upward and better peripheral visibility
- Made from 100% cotton, ABS and EVA Foam



918-5674 Grey/Orange
918-5670 Black/Red

Cup Shaped Respirators

- Soft foam nose seal
- Adjustable nose bridge
- Twin elasticated head fitting band
- Comfortable
- One size fits all
- Disposable



918-5822 FFP1 Fold Flat Respirator
918-5826 FFP2 Fold Flat Respirator
918-5829 FFP3 Valved Dolomite Respirator

Hi-Vis Vest Waistcoat

- High visibility
- Reflective tape marking – increased visibility
- Contrast panels for dirt protection



141-8168 Yellow, S
141-8169 Yellow, M
141-8170 Yellow, L
141-8174 Yellow, XL
141-8176 Yellow, XXL

Lockout Hasp

- Plated to resist chemicals and rust
- Manufactured from high tensile steel
- Thick vinyl covered padlock section to resist wear
- Each lockout accepts up to 6 padlocks with up to 9.5mm shackle diameter
- Available in two sizes, 25mm or 38mm jaw diameter



805-5506 25mm, 6 lock

805-5500 38mm, 6 lock

818-8041 16 padlock lock out station

Lockout Starter Kit

- Portable electrical department lockout tag out kit
- Provides all the basic Lockout for valves and electrical panels
- Comprises of around 24 different products
- Supplied in a tough LOTO caring bag (with handle and shoulder carrier)



862-5247

862-5244 27 Piece Kit

Miniature Circuit Breaker Lockout

- Safe and effective method for locking out miniature circuit breakers (MCB's)
- Can easily be installed with the aid of a screw driver
- Can be used on single and multipole breakers
- Single lockout padlock (not supplied), can be installed on each lockout device



862-5193 Green

862-5203 Yellow

Stainless Steel Lockout Hasp

- Has space for up to 6 individual padlocks with a shackle diameter up to 6 mm
- The padlock fixing is divided in to 3 holes and three lock combination bar
- Suitable for use in corrosive areas and near sea shore areas



862-5155 25 mm jaw diameter

Electric Flash Symbol Sign

- Self-Adhesive Electrical Hazard Warning Sign



776-0945 Vinyl Label 150 mm x 150mm

813-4423 Vinyl Label 100 mm x 100mm

776-0948 Vinyl Label 25 mm x 25mm, 250

776-0967 Vinyl Label 50 mm x 50mm, 250

Heavy Duty Cable Protectors

- Available with 2, 3 or 5 grooves which can be accessed via a top hood.
- Weather and skid proof
- Black base and yellow cover provide good visibility
- Can withstand up to 20 tons per axle
- Parts fit into one another for strong connection
- Fixed to the ground via 4 fixing holes, Ø 6 mm
- RoHS compliant



136-5423 2 channels, 32/38mm

Photoluminescent floor/wall guiding

- For sudden power failure/no lights
- Hazard warning and emergency exit
- Indoor use only



261-0520 Left, 40 mm (W) x 10 m (L)

261-0542 Right, 40 mm (W) x 10 m (L)



If you'd like to start exploring the RS PRO now, head over to our website browse the vast range.

rspro.com

CONTACT US



Singapore

133 Cecil Street
#14 - 01
Keck Seng Tower
Singapore 069535

T +65 6865 3400
E Orders.SA@rs.rsgroup.com



Phillipines

21/F Multinational
Bancorporation Centre
6805 Ayala Avenue
Makati City Philippines 1226

T +632 8888 4030
E Orders.PH@rs.rsgroup.com



Malaysia

Suite 12-9, The Office Club,
Level 12, Menara Mudajaya,
No 12A, Jalan PJU 7/3,
Mutiara Damansara,
47810 Petaling Jaya, Selangor,
Malaysia

T +603 5021 5888
E Orders.MY@rs.rsgroup.com



Thailand

50 GMM Grammy Place, 19th Floor,
Unit 1901-1904, Sukhumvit 21 Road
(Asoke), Klongtoey Nua, Wattana,
Bangkok, Thailand 10110

T +66 2 648 6868
E Orders.TH@rs.rsgroup.com



Vietnam

T +65 6865 3433
E Orders.VN@rs.rsgroup.com



Indonesia

T +65 6865 3433
E Orders.ID@rs.rsgroup.com